

## MOTOR SPECIFICATIONS

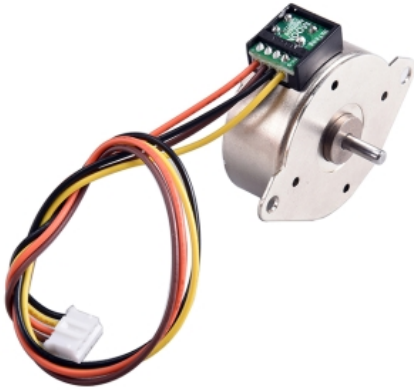

Part Number	<b>PM35S-075-038</b>
Rate Voltage	24
Constant Current	0.38A/Phase
Phase Number	2
Step Angle	7.5°
Excitation Method	Bipolar Full-Step
Insulation Class	Class B
Resistance per Phase	12Ω ± 7 ± 10%
Inductance per Phase A/B	11.9± 20%
Holding Torque	460g-cm Min
Detent Torque	75 g-cm Max
Insulation Resistance	100M? min.Ω min.

## DIMENSIONS

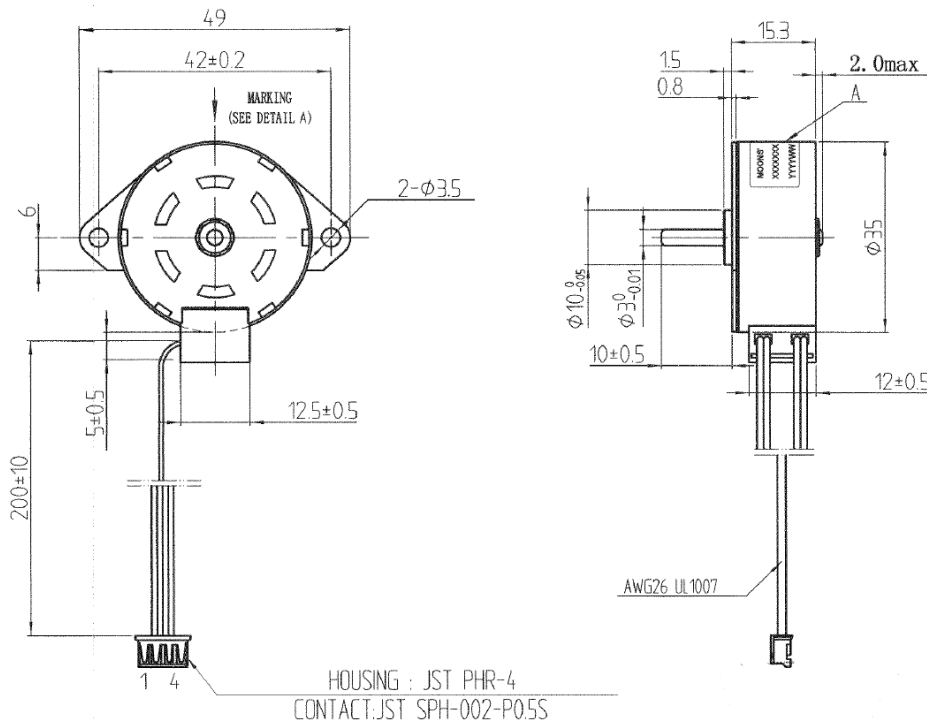

CONNECTOR PIN LOCATION						
PIN NO.	COLOR	CCW ← → CW (Seen from flange side)				PHASE
1	BLACK	ON		ON	ON	A
2	BROWN		ON	ON		$\bar{A}$
3	ORANGE	ON	ON		ON	B
4	YELLOW			ON	ON	$\bar{B}$

## PERFORMANCE CURVE

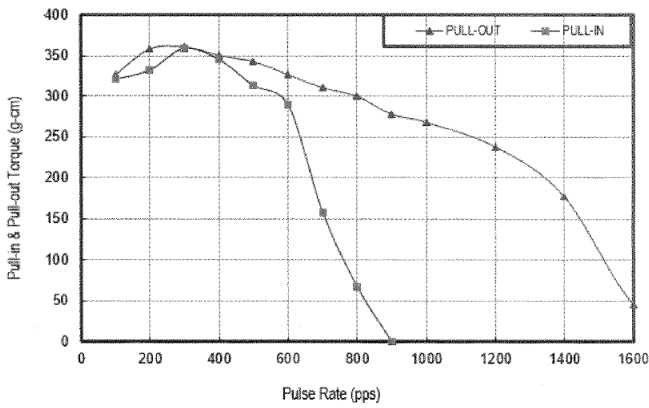

## OPERATING CONDITIONS

Operating Temperature	-20°C - +50°C
Operating Humidity	15 - 85% RH
Storage Temperature	-30°C - +70°
Storage Humidity	15 - 85% RH

## MECHANICAL SPECIFICATIONS

Radial Shaft Loading	7.5N Max
Axial Shaft Loading	1N Max
Radial Shaft Play	0.05 mm Max
Axial Shaft Play	0.6 mm Max
Mass	Approximate 70g
Rotor Inertia	Approximate 2.8 g-cm <sup>2</sup>

## OPERATION & USAGE TIPS

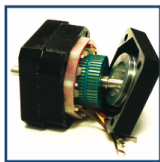

**Do not** disassemble motors; a significant reduction in motor performance will occur.

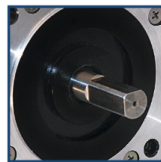

**Do not** machine shafts; this will have a negative effect on shaft run out and perpendicularity.

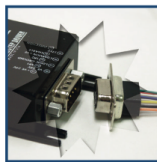

**Do not** disconnect motor from drive while in operation.

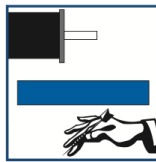

**Do not** use holding torque/detent torque of motor as a fail safe brake.



**Do not** hold motor by lead wires.



**Do not** exceed the rated current; this will burn the motor.

FAILURE TO COMPLY WITH THESE RECOMMENDATIONS WILL VOID ALL WARRANTY TERMS

## RECOMMENDED



Microstepping Driver  
**R208**



Single Axis Controller + Driver  
**R256-RO**

# Motion Control, **Solved.**

## MOTOR ENGINEERING & MANUFACTURING



Optimized  
For Your  
Application



Quick  
Prototype  
Turnaround



Small Batch  
to OEM Volume  
Production



US Based  
Support &  
Manufacturing