

# DATA SHEET

**ELECTROSTATIC DISCHARGE  
PROTECTION DEVICES**

**INDUSTRIAL / CONSUMER**

SBD52C05L01 series

RoHS compliant & Halogen free



Product specification— December 18, 2018 V.0

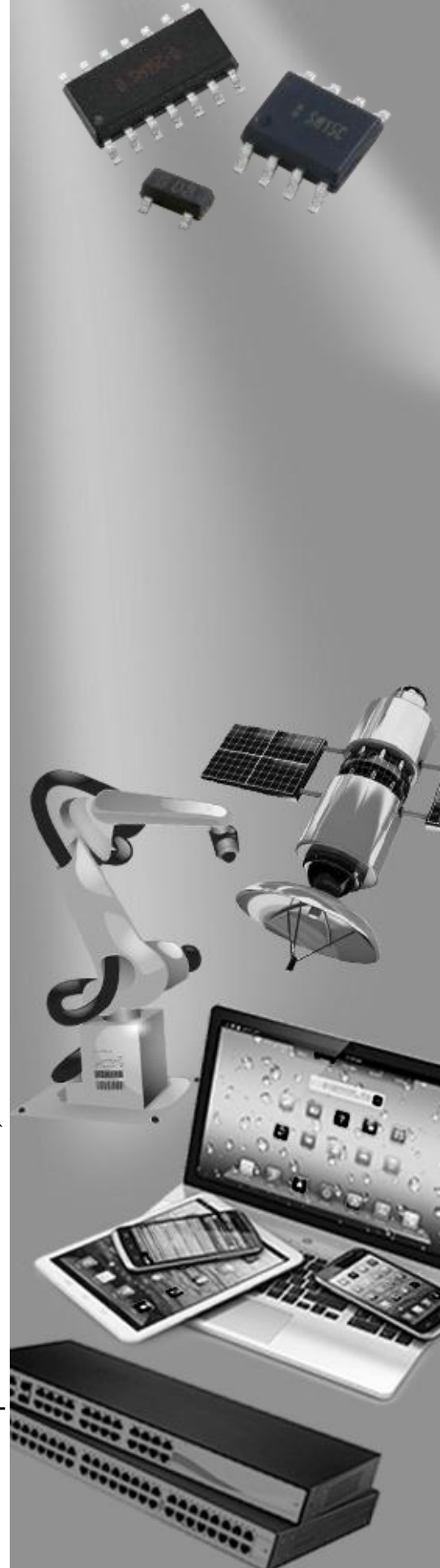

## Electrostatic Discharged Protection Devices (ESD) Data Sheet

### Description

The SBD52 series of Transient Voltage Suppressors (TVS) are designed to replace multilayer varistors (MLVs) in portable applications such as cell phones, notebook computer, and PDAs. They offer superior electrical characteristics such as lower clamping voltage and no device degradation when compared to MLVs. They are designed to protect sensitive semiconductor components from damage or upset due to electrostatic discharge (ESD), lightning, electrical fast transients (EFT), and cable discharge events (CDE).



Contact :  $\pm 8\text{kV}$   
Air :  $\pm 15\text{kV}$



### Features

- IEC61000-4-2 ESD 15KV Air, 8KV contact compliance
- IEC61000-4-4 EFT 40A 5/50ns
- SOD-523 surface mount package
- Protects bi-directional line
- Peak power dissipation of 200W under 8/20 $\mu\text{s}$  waveform
- Working voltage: 5V
- Low leakage current
- Low operating and clamping voltages
- Solid-state silicon avalanche technology
- Lead Free/RoHS compliant
- Solder reflow temperature: Pure Tin-Sn, 260~270 $^{\circ}\text{C}$
- Flammability rating UL 94V-0
- Meets MSL level 1, per J-STD-020
- Marking: 5C

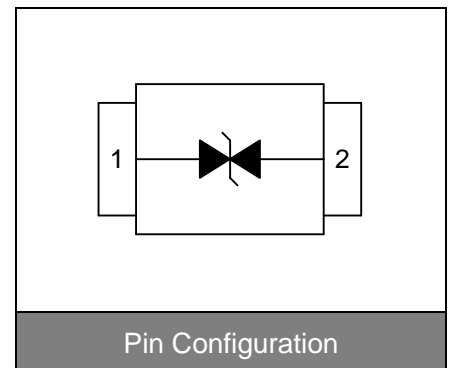

### Applications

- Cellular handsets & Accessories
- Cordless phones
- Personal digital assistants (PDAs)
- Notebooks & Handhelds
- Portable instrumentation
- Digital cameras
- Peripherals
- MP3 players

### Maximum Ratings

Rating	Symbol	Value	Unit
Peak pulse power (tp=8/20 $\mu\text{s}$ waveform)	$P_{PP}$	200	W
ESD voltage (Contact discharge)	$V_{ESD}$	$\pm 8$	kV
ESD voltage (Air discharge)		$\pm 15$	
ESD voltage (Per Human Body Model)	$V_{HBM}$	16	kV
ESD voltage (Per Machine Model)	$V_{MM}$	400	V
Storage & operating temperature range	$T_{STG}, T_J$	-55~+150	$^{\circ}\text{C}$

### Electrical Characteristics (T<sub>J</sub>=25°C)

Parameter	Symbol	Condition	Min.	Typ.	Max.	Unit
Reverse stand-off voltage	V <sub>RWM</sub>				5	V
Reverse breakdown voltage	V <sub>BR</sub>	I <sub>BR</sub> =1mA	5.6		8	V
Reverse leakage current	I <sub>R</sub>	V <sub>R</sub> =5V			5	μA
Clamping voltage (tp=8/20μs)	V <sub>C</sub>	I <sub>PP</sub> =1A			9.8	V
Off state junction capacitance	C <sub>J</sub>	0Vdc,f=1MHz		30		pF

### Typical Characteristics Curves

Figure 1. Power Derating Curve

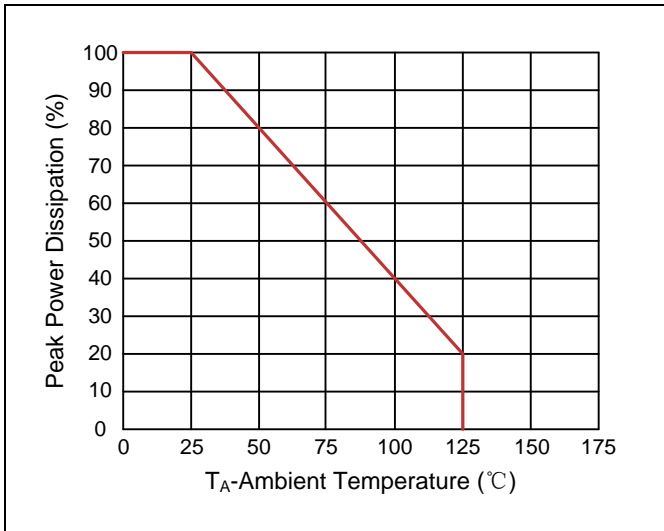

Figure 2. Pulse Waveforms

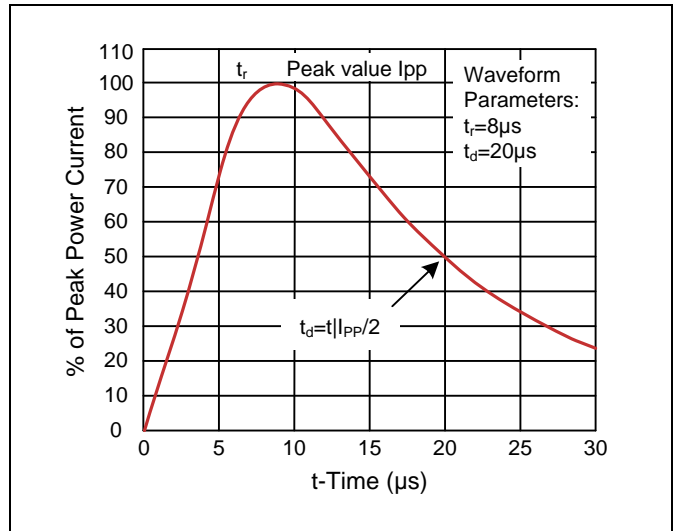

Figure 3. Clamping Voltage vs. Peak Pulse Current

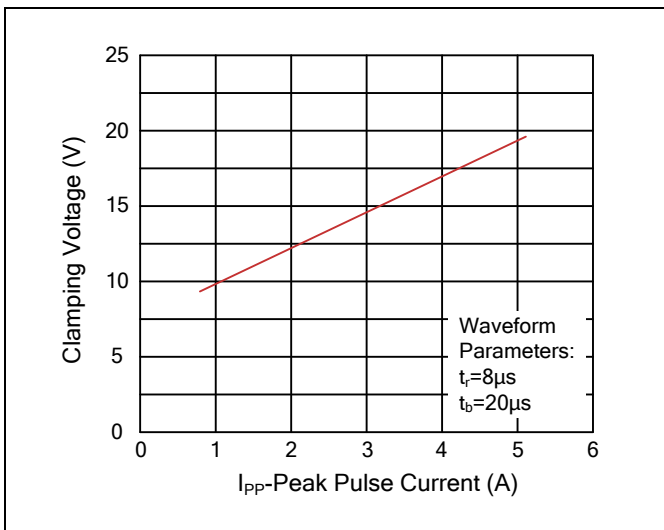
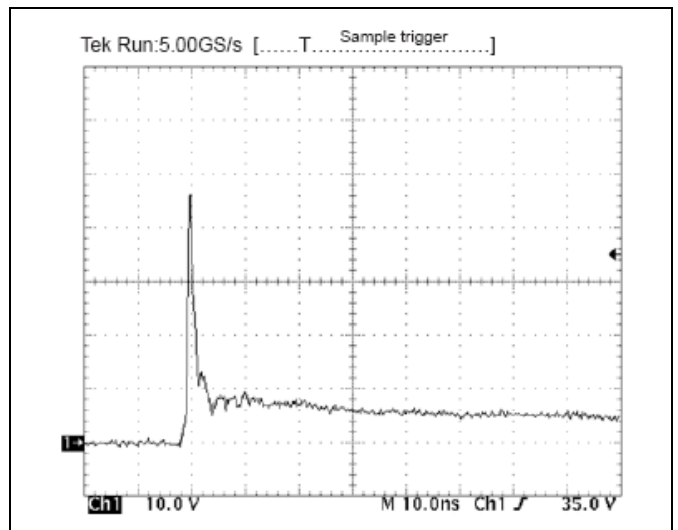
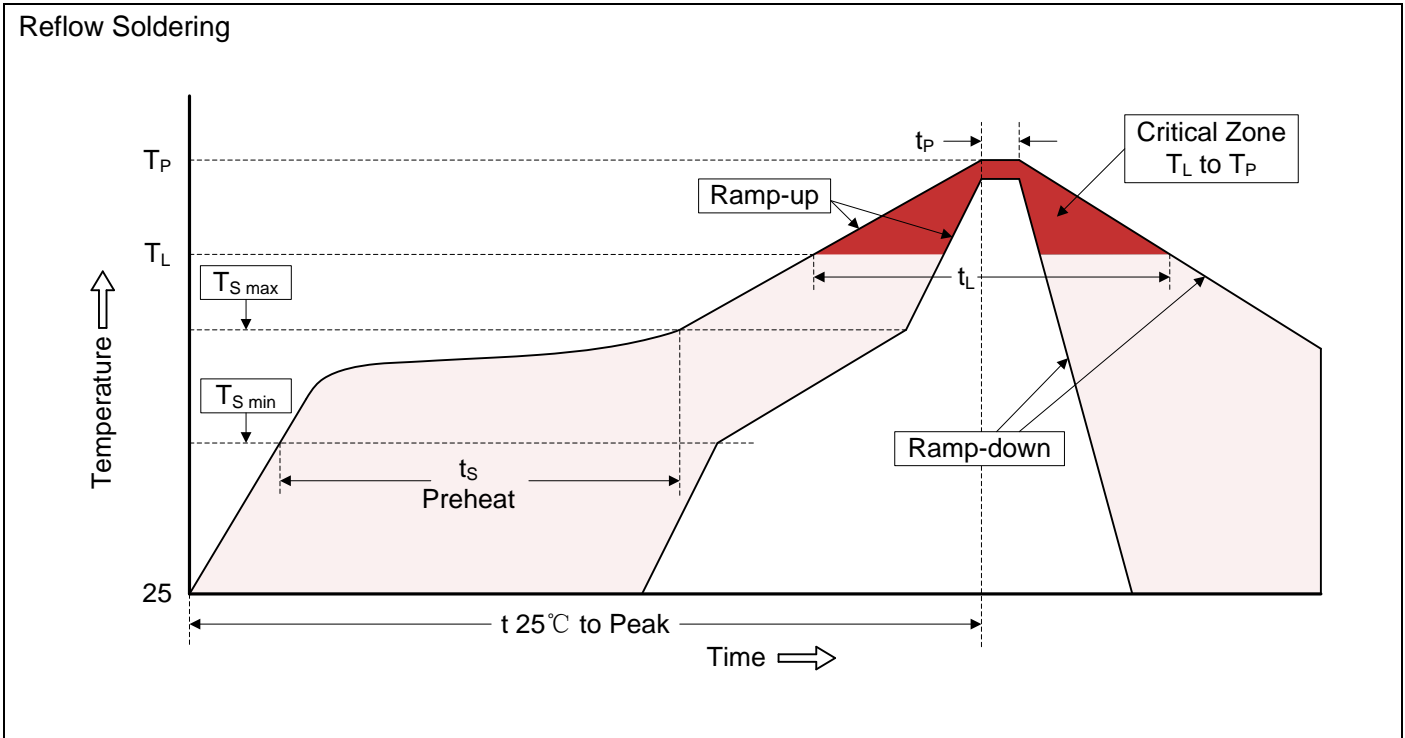

Figure 4. ESD Clamping(8kV Contact IEC61000-4-2)



### Recommended Soldering Conditions



#### Recommended Conditions

Profile Feature	Pb-Free Assembly
Average ramp-up rate ( $T_L$ to $T_P$ )	3°C/second max.
Preheat	
-Temperature Min ( $T_{S\ min}$ )	150°C
-Temperature Max ( $T_{S\ max}$ )	200°C
-Time (min to max) ( $t_s$ )	60-180 seconds
$T_{S\ max}$ to $T_L$	
-Ramp-up Rate	3°C/second max.
Time maintained above:	
-Temperature ( $T_L$ )	217°C
-Time ( $t_L$ )	60-150 seconds
Peak Temperature ( $T_P$ )	260°C
Time within 5°C of actual Peak Temperature ( $t_P$ )	20-40 seconds
Ramp-down Rate	6°C/second max.
Time 25°C to Peak Temperature	8 minutes max.

**Dimensions (SOD-523)**

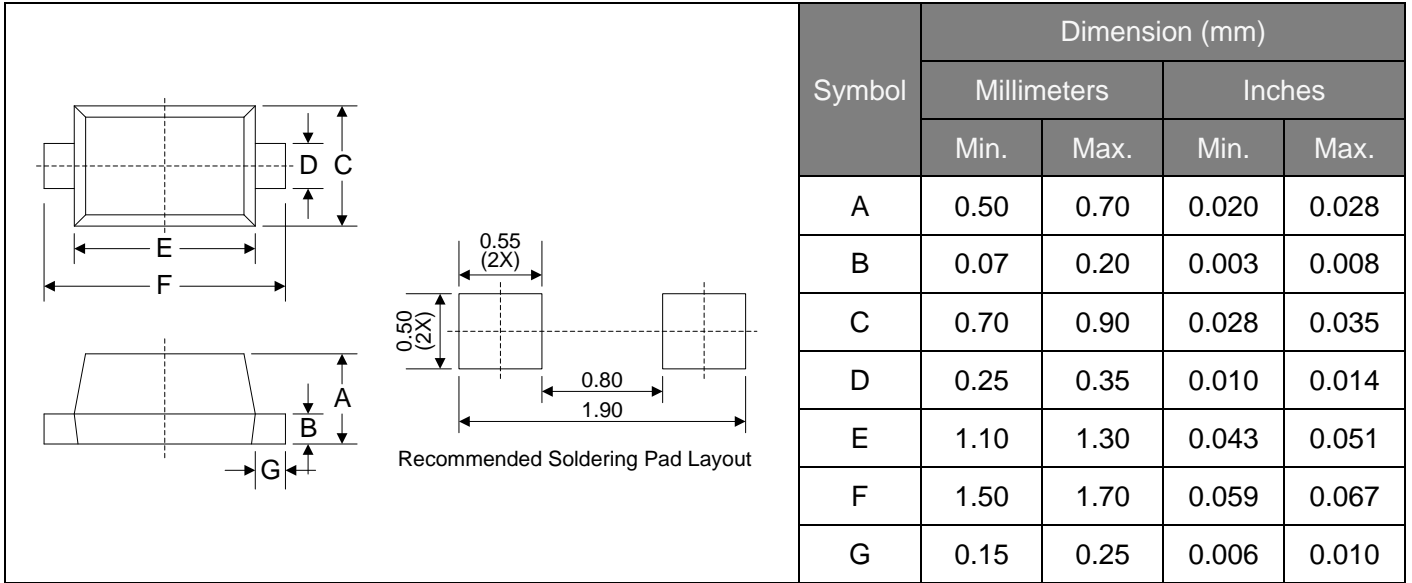

**Packaging**

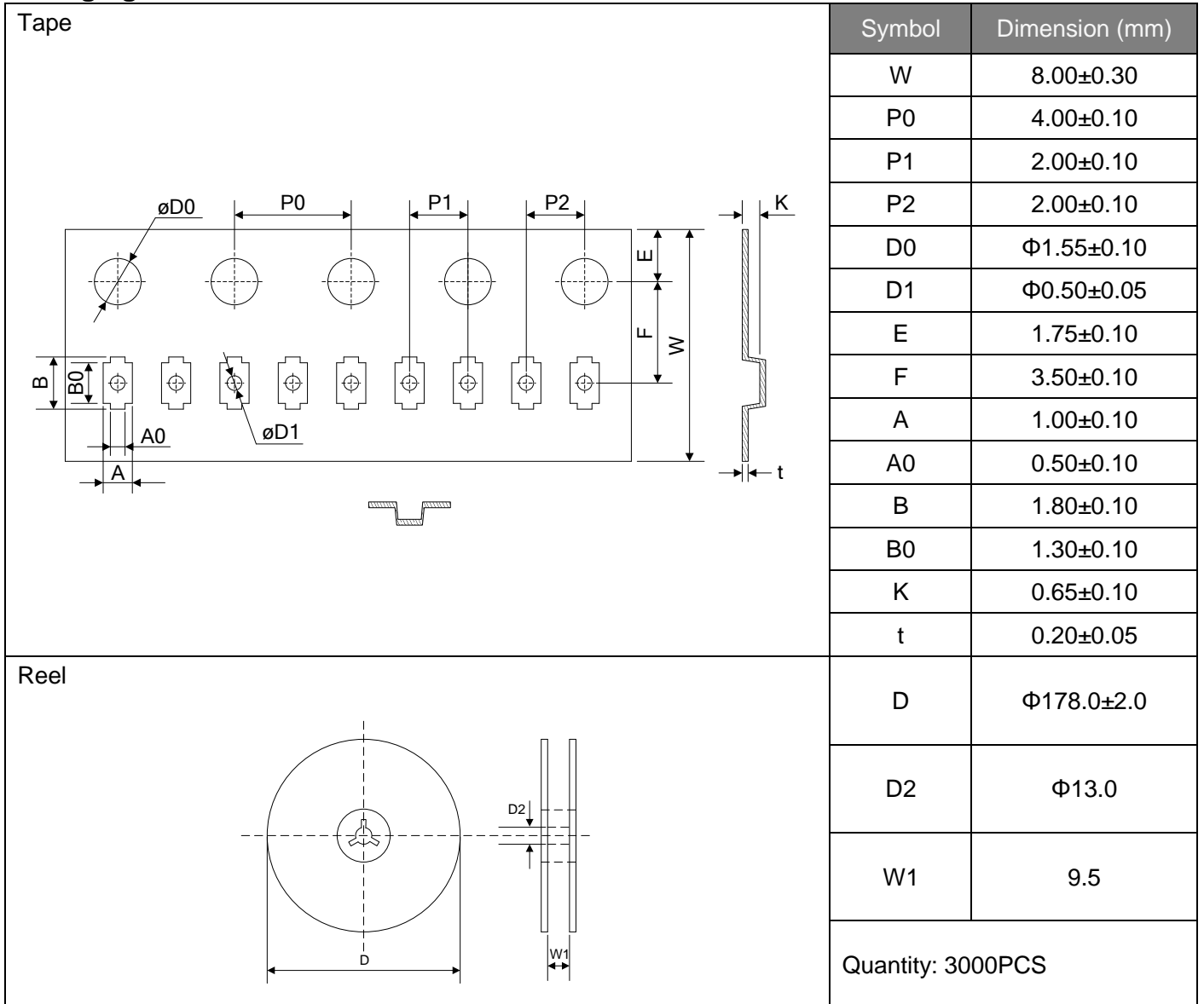

# Mouser Electronics

Authorized Distributor

Click to View Pricing, Inventory, Delivery & Lifecycle Information:

[Yageo:](#)

[SBD52C05L01](#)