

Datamate

Contents

	Introduction	74
Datamate Mix-Tek: 2.00/4.00mm pitch High-Reliability Connectors		
	Specifications	76
	Power Connectors	78
	Power/Signal Connectors	85
	Coax Connectors	90
	Housings Only	95
	Contacts	102
	Metal Backshells	105
Datamate J-Tek: Jackscrew 2.00mm pitch High-Reliability Connectors		
	Specifications	108
	Female Connectors & Cable Assemblies	111
	Female T-Contact & Cable Assemblies	127
	Female Backshells	132
	Male Connectors & Cable Assemblies	133
	Male Backshells	149
	Flex Circuit Assemblies	150
Datamate J-Tek 3-Row: 2.00mm pitch High-Reliability Connectors		
	Specifications	151
	Female Connectors	152
	Male Connectors	155
Datamate L-Tek: Latched 2.00mm pitch High-Reliability Connectors		
	Specifications	157
	Female Connectors & Cable Assemblies	159
	Male Connectors	166
	Tooling	174

Datamate Connectors Introduction

Datamate is a 2mm pitch High-Reliability, high performance connector range from Harwin. The range has a proven track record for performance under extreme conditions, and complies with British Standard 9525-F0033.

Datamate provides a low-profile solution for all variations of cable-to-board, board-to-board and cable-to-cable interconnect requirements. The range has seen many developments to match customer and market demands, and now includes 1-, 2- and 3-row configurations, vertical and horizontal in both Throughboard and Surface Mount designs for PCB flexibility. To meet the demanding requirements of vibration, shock and acceleration, added security is available with the options of latches (for space-saving) or jackscrews (for maximum strain-relief).

With the addition of Datamate Mix-Tek, the 3A signal contacts can be supplied in the same connector as 20A power, 40A high power, or 6GHz coax connections, giving complete flexibility of design. Other range additions include the 101Lok fixing – designed for fast mating with a quarter-turn bayonet-style jackscrew.

- ❖ 3A per contact (all electrically loaded; 3.3A per individual contact)
- ❖ 4-finger contact design to maintain electrical contact through high vibration and shock
- ❖ Beryllium Copper Contact for improved temperature range: -55°C to +125°C
- ❖ 500 Mating cycles durability
- ❖ Professional connector system at commercial prices
- ❖ Ongoing development program for High-Reliability connectors from Harwin
- ❖ Online videos and Cable assembly facility for assistance with cabling requirements

Datamate Signal

- ❖ Strong stainless steel jackscrew fixings for maximum strain relief, or lightweight space-saving locking latches
- ❖ Lightweight metal and plastic hood options for shielding and additional cable protection
- ❖ Choices of pre-wired contacts or full cable assemblies from stock, for prototyping and full production

Datamate Mix-Tek

- ❖ Multiple variations of power-only, power-and-signal, or coax only variations of connectors, available from stock
- ❖ Full cable assembly options for coax and power, in 2/4/6/8 contact connectors on 4mm pitch
- ❖ Compatible with lightweight metal hoods for shielding and cable protection

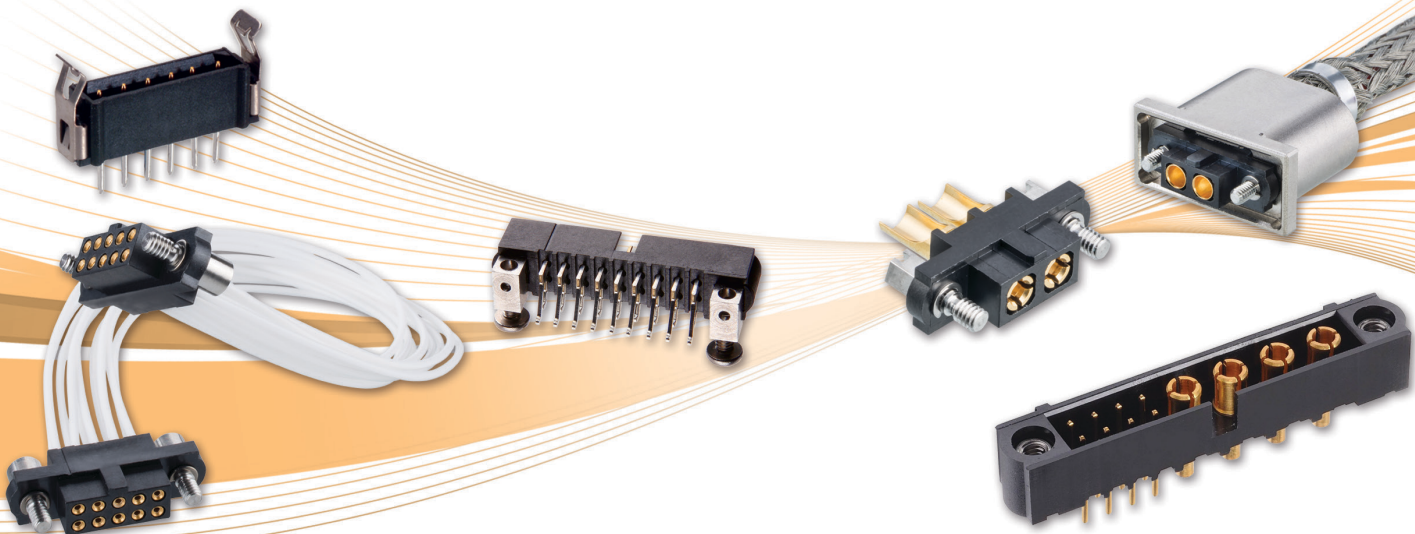

Datamate Connectors Product Features

Four Finger Beryllium Copper Contact

Proven high-reliability contact design ensures signal integrity under extremes of bump, vibration and shock. Durable to over 500 mating cycles.

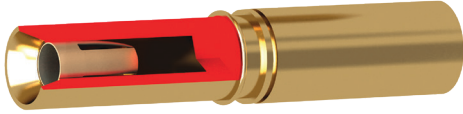

Polarization

All Datamate designs feature polarization to prevent mis-mating in everyday use.

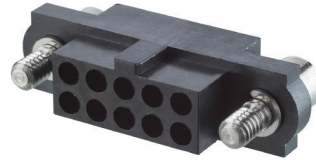

Rugged construction

For use in harsh environments where high vibration, shock and temperature are a consideration.

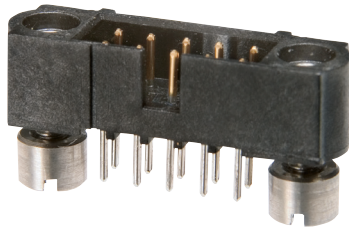

Innovative fast-acting bayonet fixing

101Lok utilises a 101-degree turn to quickly and simply lock mating connectors together.



Ready-made Cable Assemblies

Wide selection of stocked single and double-ended cable assemblies, with jackscrews or latching connectors, signal or power contacts.



Single piece metal Backshells for EMC Shielding

Compatible with the J-Tek and Mix-Tek connector ranges, these robust hoods provide full 360° shielding, complete with retention feature on cable exit for fixing additional braiding.

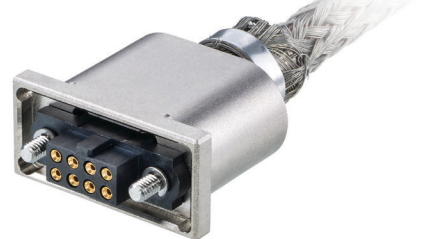

Low outgassing emissions

Plastic housings with outgassing emissions within NASA & ESA recommendations, ready for space and low-pressure research.



Comprehensive Operating Temperature

All connectors suitable for operational temperatures from -55°C to +125°C, due to high quality material choice.

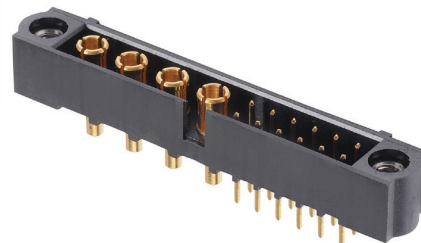

All dimensions in mm.

Datamate Mix-Tek Specification

Materials

Housings:	Glass-filled thermoplastic UL94V-0
Female contacts:	Brass shell, with Beryllium Copper inner contact
Male contacts:	Copper alloy
Finish:	See individual pages

Electrical

Current	
Individual contacts in isolation:	3.3A max (at 25°C) 2.6A max (at 85°C)
All contacts simultaneously:	3.0A max (at 25°C) 2.2A max (at 85°C)
Working voltage	
At sea level 1013 mbar:	800V DC or AC _{rms}
Voltage proof	
At sea level 1013 mbar:	1,200V DC or AC _{rms}
Contact resistance	
Initial:	20mΩ max
After conditioning:	25mΩ max
Insulation resistance	
Initial:	1,000MΩ min
After conditioning:	100MΩ min

Mechanical

Durability:	500 operations
Insertion force (max):	2.8N
Withdrawal force (min):	0.2N
Signal crimp accommodation:	22 AWG to 28 AWG BS 3G 210 Type A

Environmental

Environmental classification:	55/125/56 days at 95% RH
Operational temperature:	-55°C to +125°C
*Vibration sensitivity:	10Hz to 2000Hz, 0.75mm, 98m/s ² (10G), duration 6h
*Bump severity:	390m/s ² (40G), 4000 ±10 bumps
*Shock severity:	981m/s ² (100G) for 6ms
*Acceleration severity:	490m/s ² (50G)

* Tested with connectors with Jackscrews.

Power Contacts

Materials

Latching collar:	Beryllium Copper, Nickel plated
Other metallic parts:	Copper alloy, Gold plated

Electrical

Current (in isolation)	
32x, 33x:	20A max
PFx, PMx:	40A nominal, up to 80A max
Contact resistance:	6mΩ max

Mechanical

Insertion force (max)	
32x, 33x:	8N
PFx, PMx:	15N
Withdrawal force (min):	0.5N
Contact replacement in connector:	
	5 times
Power contact accommodation	
32x, 33x:	12 to 20 AWG
PFx, PMx:	10 AWG

All dimensions in mm.

Coax Contacts

Materials

Latching collar:	Beryllium Copper, Nickel plated
Other metallic parts:	Copper alloy, Gold plated
Insulator:	PTFE

Electrical

Frequency range:	6GHz (depending on cable)
Impedance:	50Ω
VSWR:	1.05 + (0.04 x Frequency) GHz max
Operating voltage (sea level):	180V AC at 500mA
Maximum voltage (sea level):	1000V AC _{rms}
Contact resistance:	6mΩ max
Insulation resistance:	10 ⁶ MΩ at 250V AC _{rms}

Mechanical

Insertion force (max):	8N
Withdrawal force (min):	0.5N
Contact replacement in connector:	5 times

Datamate Mix-Tek Pin Numbering

	FEMALE	MALE
POWER OR COAX ONLY		
SIGNAL AND POWER		

Mating Profiles

		FEMALE	
		VERTICAL THROUGHBOARD	CRIMP
MALE	VERTICAL THROUGHBOARD		
	HORIZONTAL THROUGHBOARD		
	CRIMP		

All dimensions in mm.

Datamate Power Connectors

- Standard high-reliability connectors fitted with power contacts on 4mm pitch.

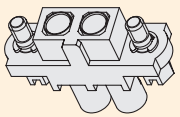
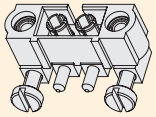
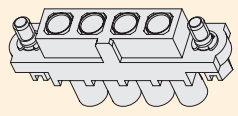
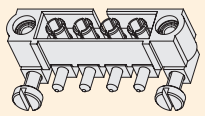
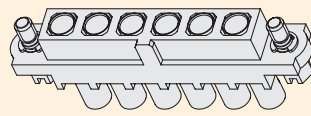
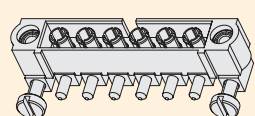
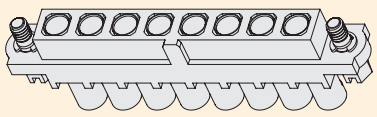
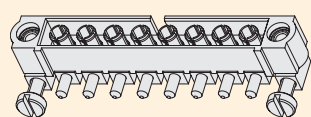
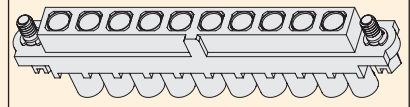
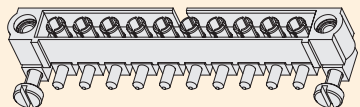
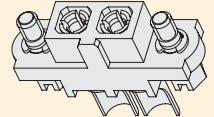
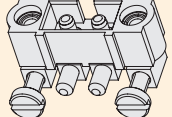
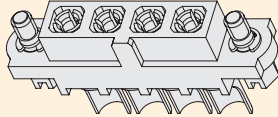
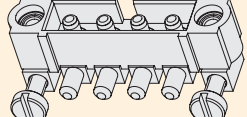
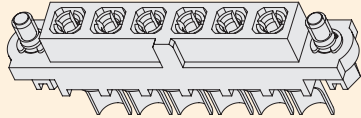
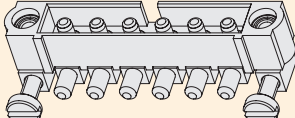
		TYPE		
		Cable Assemblies	Female Cable - Hex Slotted Jackscrews	Male Horizontal 3.5mm PC Tail - 5mm Board Mount Jackcrew
TOTAL NO. OF CONTACTS	2 Power	Female Single Ended (Female to Cut End) Hex Socket Jackscrews M80-FC325F1-02-0150L Male Single Ended (Male to Cut End) Jackscrew Fixing M80-MC335M1-02-0150L	 M80-4000000F1-02-325-00-000	 M80-5000000M5-02-333-00-000
	4 Power	Female Single Ended (Female to Cut End) Hex Socket Jackscrews M80-FC325F1-04-0150L Male Single Ended (Male to Cut End) Jackscrew Fixing M80-MC335M1-04-0150L	 M80-4000000F1-04-325-00-000	 M80-5000000M5-04-333-00-000
	6 Power	Female Single Ended (Female to Cut End) Hex Socket Jackscrews M80-FC325F1-06-0150L Male Single Ended (Male to Cut End) Jackscrew Fixing M80-MC335M1-06-0150L	 M80-4000000F1-06-325-00-000	 M80-5000000M5-06-333-00-000
	8 Power	Female Single Ended (Female to Cut End) Hex Socket Jackscrews M80-FC325F1-08-0150L Male Single Ended (Male to Cut End) Jackscrew Fixing M80-MC335M1-08-0150L	 M80-4000000F1-08-325-00-000	 M80-5000000M5-08-333-00-000
	10 Power		 M80-4000000F1-10-325-00-000	 M80-5000000M5-10-333-00-000
	2 High Power	Female Single Ended (Female to Cut End) Hex Socket Jackscrews M80-FCPF5F1-02-0150L Male Single Ended (Male to Cut End) Jackscrew Fixing M80-MCPM5M1-02-0150L	 M80-4000000F1-02-PF5-00-000	 M80-5000000M5-02-PM3-00-000
	4 High Power	Female Single Ended (Female to Cut End) Hex Socket Jackscrews M80-FCPF5F1-04-0150L Male Single Ended (Male to Cut End) Jackscrew Fixing M80-MCPM5M1-04-0150L	 M80-4000000F1-04-PF5-00-000	 M80-5000000M5-04-PM3-00-000
	6 High Power	Female Single Ended (Female to Cut End) Hex Socket Jackscrews M80-FCPF5F1-06-0150L Male Single Ended (Male to Cut End) Jackscrew Fixing M80-MCPM5M1-06-0150L	 M80-4000000F1-06-PF5-00-000	 M80-5000000M5-06-PM3-00-000
	8 High Power	Female Single Ended (Female to Cut End) Hex Socket Jackscrews M80-FCPF5F1-08-0150L Male Single Ended (Male to Cut End) Jackscrew Fixing M80-MCPM5M1-08-0150L		

All dimensions in mm.

Datamate Power Connectors

Standard high-reliability connectors fitted with power contacts on 4mm pitch.

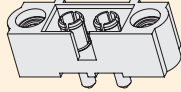
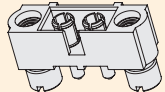
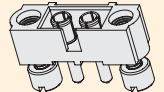
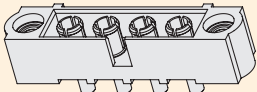
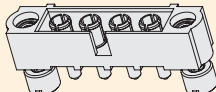
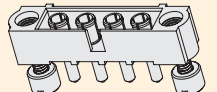
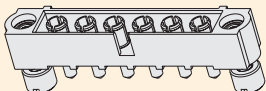
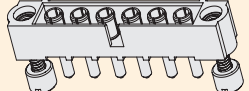
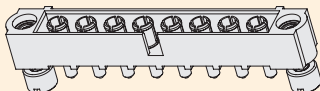
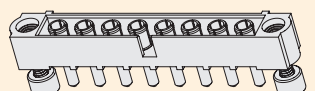
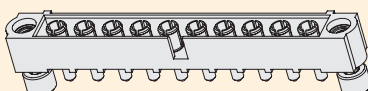
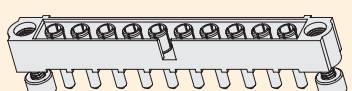
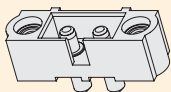
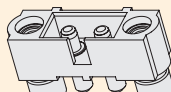
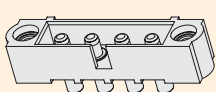
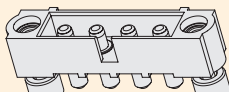
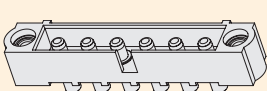
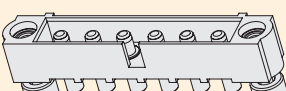
		TYPE		
		Male Vertical 3.5mm Tail - Jackscrew Fixing	Male Vertical 3.5mm Tail - 3.5mm Board Mount Jackcrew	Male Vertical 5mm Tail - 5mm Board Mount Jackcrew
TOTAL NO. OF CONTACTS	2 Power	 M80-5000000M1-02-331-00-000	 M80-5000000M2-02-331-00-000	 M80-5000000M3-02-332-00-000
	4 Power	 M80-5000000M1-04-331-00-000	 M80-5000000M2-04-331-00-000	 M80-5000000M3-04-332-00-000
	6 Power		 M80-5000000M2-06-331-00-000	 M80-5000000M3-06-332-00-000
	8 Power		 M80-5000000M2-08-331-00-000	 M80-5000000M3-08-332-00-000
	10 Power		 M80-5000000M2-10-331-00-000	 M80-5000000M3-10-332-00-000
	2 High Power	 M80-5000000M1-02-PM1-00-000	 M80-5000000M2-02-PM1-00-000	
	4 High Power	 M80-5000000M1-04-PM1-00-000	 M80-5000000M2-04-PM1-00-000	
	6 High Power	 M80-5000000M1-06-PM1-00-000	 M80-5000000M2-06-PM1-00-000	

All dimensions in mm.

Datamate Power Connectors

Female Power Cable Connector Kit

- Part numbers are for a complete kit of a housing and the applicable number of contacts.
- Hexagonal slotted jackscrews are assembled where specified.
- Polarized housings.
- Standard Power contacts rated to 20A, High Power to 40A.

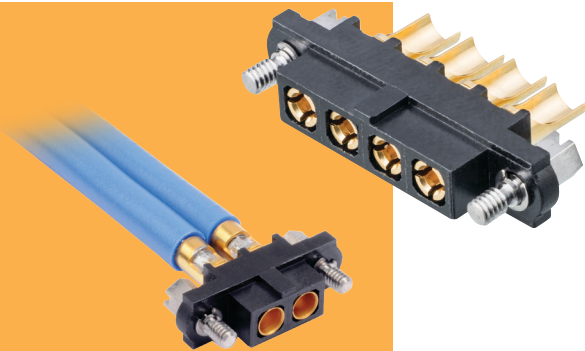

DATAMATE POWER

POWER CONTACTS ONLY		CALCULATION		SPARE SOLDER CONTACTS	
Standard Power (12 AWG)		A	B + 14	Standard Power (12 AWG)	
		B	(No. of Power contacts - 1) x 4		
		C	B + 9		
High Power (10 AWG)				High Power (10 AWG)	
				ORDER CODE M80-325	
				ORDER CODE M80-PF5	
TOOLS		WIRE STRIPPING DETAILS			
Contact Removal Tool - Z80-290 ❖ No special tooling required for connecting wire, other than standard soldering equipment.					
HOW TO ORDER					
M80 - 4000000F1 - XX - XXX - 00 - 000					
NO. OF POWER CONTACTS				POWER CONTACTS PART NO.	
02, 04, 06, 08, 10	Standard Power			325	Standard Power
02, 04, 06	High Power			PF5	High Power

All dimensions in mm.

Datamate Power Connectors

Female Cable Assemblies

- Ready-made cable assemblies, fully tested and inspected.
- Standard Power contacts are rated to 20A, and are fitted with 12AWG, white PTFE-insulated cables.
- High Power are rated to 40A nominal, up to 80A max. Fitted with 10AWG, white PTFE-insulated cables.
- Cable assemblies are constructed with Contact A to Contact A, Contact B to Contact B, etc.



DATAMATE POWER

STANDARD POWER

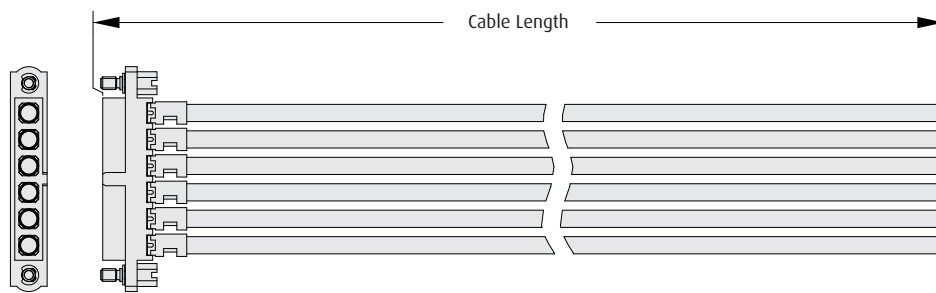

HIGH POWER

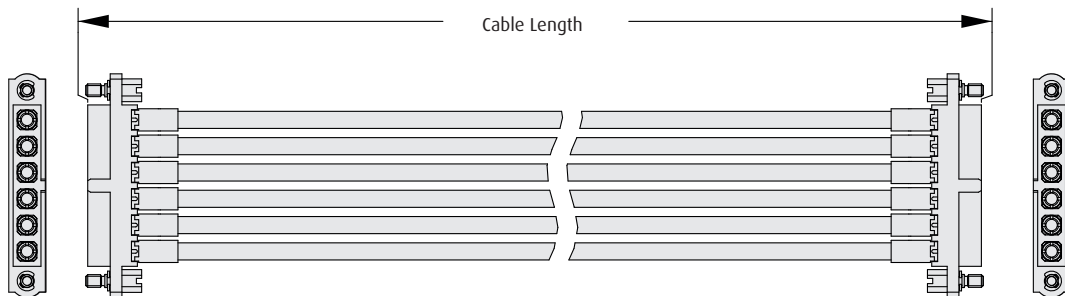

HOW TO ORDER

M80 - FC XXX F1 - XX - XXXX XX

SERIES CODE

POWER CONTACTS PART NO.

325	Standard Power
PF5	High Power

JACKSCREW

F1	Hex Slotted Jackscrews
-----------	------------------------

TERMINATION - SECOND END

L	Loose cut end
F1	Female connector

CABLE LENGTH

0150	150mm
XXXX	XXXXmm

NO. OF POWER CONTACTS

02, 04, 06, 08

All dimensions in mm.

Datamate Power Connectors

Male Vertical Throughboard

- ❖ A selection of stocked Datamate Mix-Tek solder tail standard layouts.
- ❖ Choice to suit two PCB thicknesses and two stud lengths.
- ❖ Standard Power contacts rated to 20A.
- ❖ High Power rated to 40A nominal, up to 80A max.

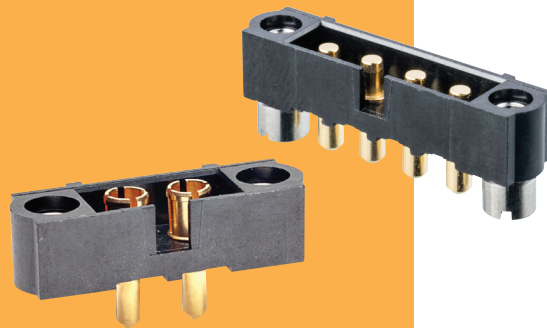

STANDARD POWER

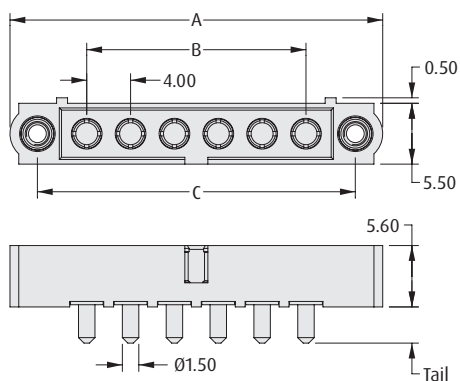

Jackscrew fixing

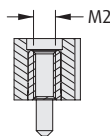

Jackscrew with Board Mount

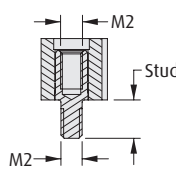

Recommended PC Board Pattern

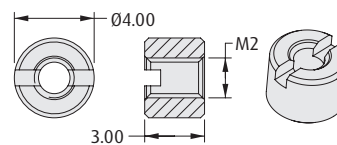
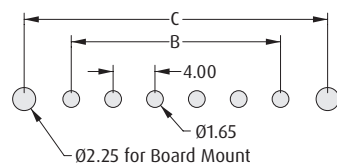

Board Mount Nut, 2 per connector

CALCULATION

A	$B + 14$
B	$(\text{No. of Power contacts} - 1) \times 4$
C	$B + 9$

HIGH POWER

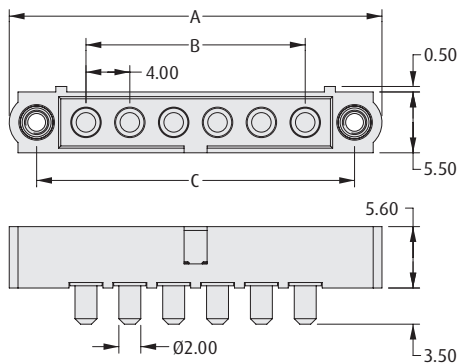

Jackscrew fixing

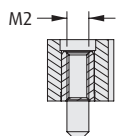

Jackscrew with Board Mount

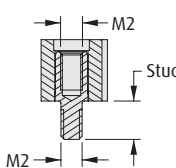

Recommended PC Board Pattern

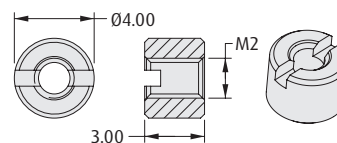
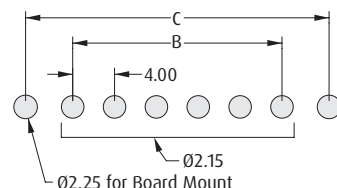

Board Mount Nut, 2 per connector

HOW TO ORDER

M80 - 5000000 XX - XX - XXX - 00 - 000

JACKSCREW

M1	Jackscrew only
M2	With 3.5mm Board Mount stud
M3	With 5mm Board Mount stud

Check image chart to confirm Off-The-Shelf sizes available

NO. OF POWER CONTACTS

02, 04	Standard Power (M1 Jackscrews)
02, 04, 06, 08, 10	Standard Power (M2/M3 Jackscrews)
02, 04, 06	High Power (M1/M2 Jackscrews)

POWER CONTACTS PART NO.

331	3.5mm Tail Standard Power
332	5mm Tail Standard Power
PM1	3.5mm Tail High Power

All dimensions in mm.

Datamate Power Connectors

Male Horizontal Throughboard

- Choice to suit two PCB thicknesses and two stud lengths.
- Standard Power contacts rated to 20A.
- High Power rated to 40A nominal, up to 80A max.



STANDARD POWER

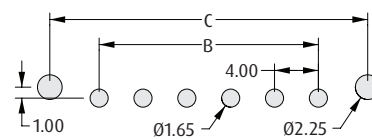
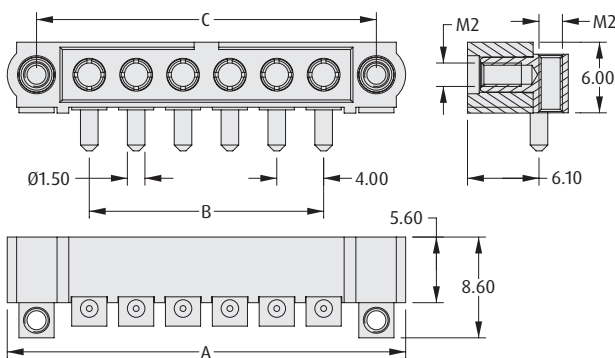

Recommended PC Board Pattern

Board Mount Bolt,
2 per connector

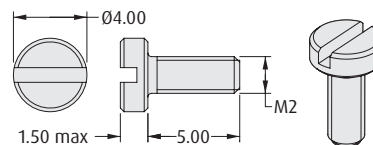

CALCULATION

A	$B + 14$
B	$(\text{No. of Power contacts} - 1) \times 4$
C	$B + 9$

HIGH POWER

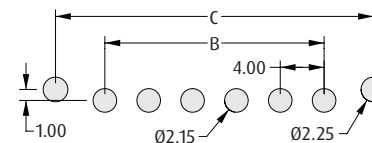
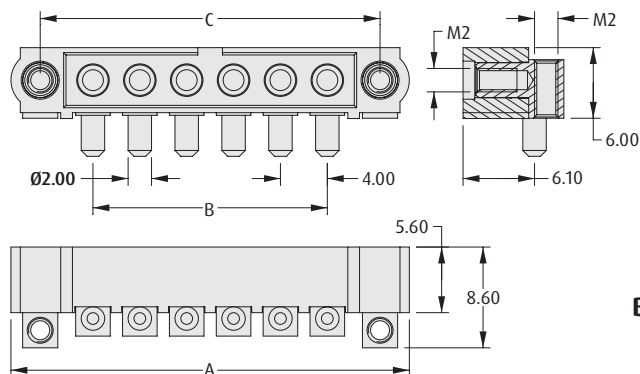

Recommended PC Board Pattern

Board Mount Bolt,
2 per connector

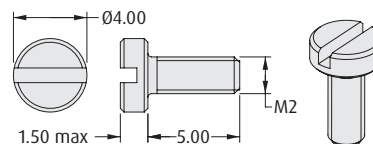

HOW TO ORDER

M80 - 500000 M5 - XX - XXX - 00 - 000

NO. OF POWER CONTACTS	
02, 04, 06, 08, 10	Standard Power
02, 04, 06,	High Power

POWER CONTACTS PART NO.	
333	3.5mm Tail Standard Power
PM3	3.5mm Tail High Power

All dimensions in mm.

Datamate Power Connectors

Male Cable Assemblies

- ❖ Ready-made cable assemblies, fully tested and inspected.
- ❖ Standard Power contacts are rated to 20A, and are fitted with 12AWG, white PTFE-insulated cables.
- ❖ High Power are rated to 40A nominal, up to 80A max. Fitted with 10AWG, white PTFE-insulated cables.
- ❖ Cable assemblies are constructed with Contact A to Contact A, Contact B to Contact B, etc.



DATAMATE POWER

MALE SINGLE-ENDED

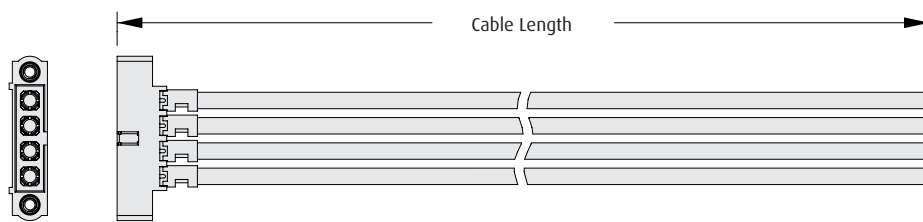

MALE - FEMALE

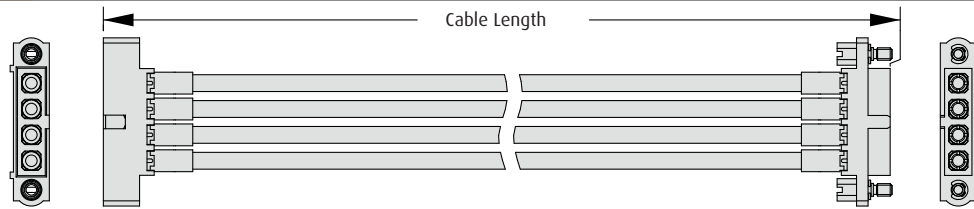

MALE - MALE

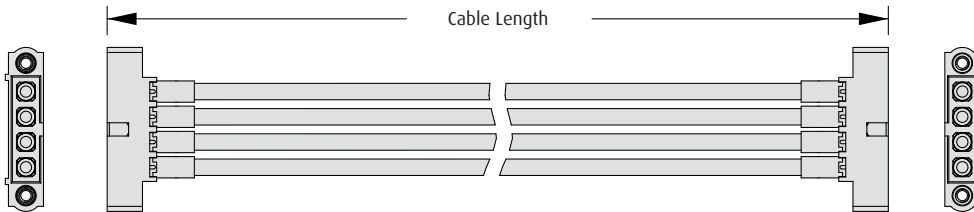

HOW TO ORDER

M80 - MC XXX M1 - XX - XXXX XX

SERIES CODE

POWER CONTACTS PART NO.

335	Standard Power
PM5	High Power

JACKSCREW

M1	Internal Jackscrews
-----------	---------------------

TERMINATION - SECOND END

L	Loose cut end
F1	Female (Floating Hex Slotted Jackscrew)
M1	Male connector

CABLE LENGTH

0150	150mm
XXXX	XXXXmm

NO. OF POWER CONTACTS

02, 04, 06, 08

All dimensions in mm.

Datamate Power/Signal Connectors

- Standard high-reliability connectors fitted with a combination of signal and 20A power contacts.

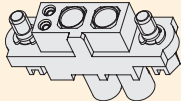
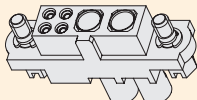
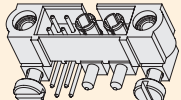
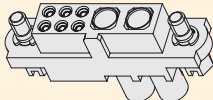
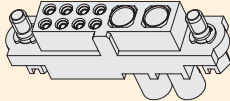
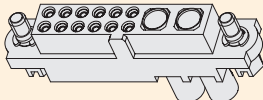
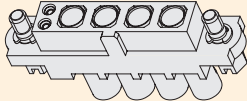
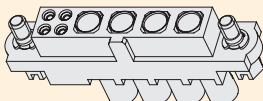
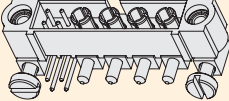
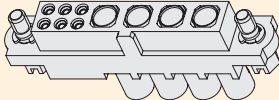
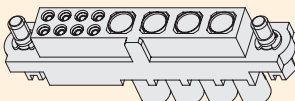
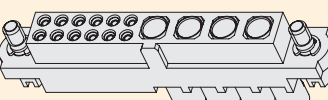
		TYPE	
		Female Cable - Hex Slotted Jackscrews	Male Horizontal 3mm Tail - 5mm Board Mount Jackcrew
TOTAL NO. OF CONTACTS	2 Power	 <p>M80-4C10205F1-02-325-00-000</p>	
	4 Signal	 <p>M80-4C10405F1-02-325-00-000</p>	 <p>M80-5L10405M5-02-333-00-000</p>
	6 Signal	 <p>M80-4C10605F1-02-325-00-000</p>	
	8 Signal	 <p>M80-4C10805F1-02-325-00-000</p>	
	12 Signal	 <p>M80-4C11205F1-02-325-00-000</p>	
TOTAL NO. OF CONTACTS	4 Power	 <p>M80-4C10205F1-04-325-00-000</p>	
	4 Signal	 <p>M80-4C10405F1-04-325-00-000</p>	 <p>M80-5L10405M5-04-333-00-000</p>
	6 Signal	 <p>M80-4C10605F1-04-325-00-000</p>	
	8 Signal	 <p>M80-4C10805F1-04-325-00-000</p>	
	12 Signal	 <p>M80-4C11205F1-04-325-00-000</p>	

All dimensions in mm.

Datamate Power/Signal Connectors

DATAMATE POWER/SIGNAL

- Standard high-reliability connectors fitted with a combination of signal and 20A power contacts.

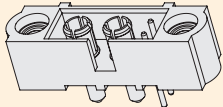
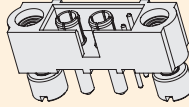
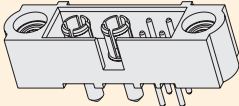
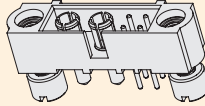
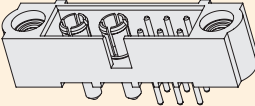
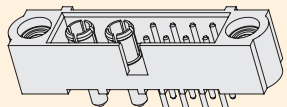
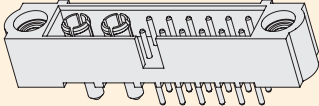
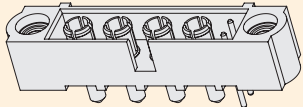
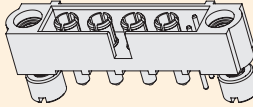
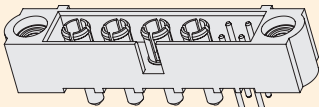
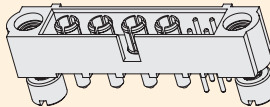
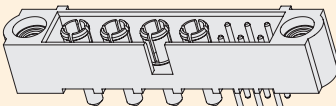
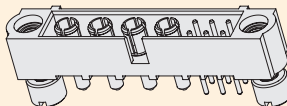
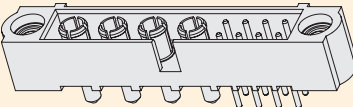
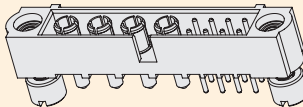
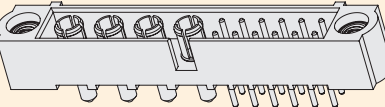
		TYPE		
		Male Vertical 3mm Tail - Jackscrew fixing	Male Vertical 3mm Tail - 3.5mm Board Mount Jackcrew	
TOTAL NO. OF CONTACTS	2 Power	2 Signal	 M80-5T10205M1-02-331-00-000	 M80-5T10205M2-02-331-00-000
		4 Signal	 M80-5T10405M1-02-331-00-000	 M80-5T10405M2-02-331-00-000
		6 Signal	 M80-5T10605M1-02-331-00-000	
		8 Signal	 M80-5T10805M1-02-331-00-000	
		12 Signal	 M80-5T11205M1-02-331-00-000	
TOTAL NO. OF CONTACTS	4 Power	2 Signal	 M80-5T10205M1-04-331-00-000	 M80-5T10205M2-04-331-00-000
		4 Signal	 M80-5T10405M1-04-331-00-000	 M80-5T10405M2-04-331-00-000
		6 Signal	 M80-5T10605M1-04-331-00-000	 M80-5T10605M2-04-331-00-000
		8 Signal	 M80-5T10805M1-04-331-00-000	 M80-5T10805M2-04-331-00-000
		12 Signal	 M80-5T11205M1-04-331-00-000	

All dimensions in mm.

Datamate Power/Signal Connectors

Female Power/Signal Cable Connector Kit

- ❖ Part numbers are for a complete kit of a housing and the applicable number of contacts.
- ❖ Hexagonal slotted jackscrews are assembled.
- ❖ Polarized housings.
- ❖ Standard Power contacts rated to 20A, signal to 3A.



DATAMATE POWER/SIGNAL

SIGNAL AND POWER	CALCULATION	SPARE CONTACTS						
	<table border="1"> <tr> <td>A</td> <td>B + 13</td> </tr> <tr> <td>B</td> <td>(No. of Power contacts - 1) x 4 + Total no. of Signal contacts + 1</td> </tr> <tr> <td>C</td> <td>B + 8</td> </tr> </table>	A	B + 13	B	(No. of Power contacts - 1) x 4 + Total no. of Signal contacts + 1	C	B + 8	<p>Signal (24 to 28 AWG)</p> <p>Indent Groove</p> <p style="background-color: #f4a460; color: white; padding: 2px;">ORDER CODE M80-0130005</p> <p>Standard Power (12 AWG)</p> <p style="background-color: #f4a460; color: white; padding: 2px;">ORDER CODE M80-325</p>
	A	B + 13						
	B	(No. of Power contacts - 1) x 4 + Total no. of Signal contacts + 1						
C	B + 8							
<p>TOOLS</p> <p>Recommended Crimp Tool (Signal) - M22520/2-01 Positioner (Signal) - T5747 Contact Insertion/Removal Tool (Signal) - Z80-280 Contact Removal Tool (Power) - Z80-290</p> <ul style="list-style-type: none"> ❖ No special tooling required for connecting Power wire, other than standard soldering equipment. ❖ Instruction sheets available at www.harwin.com/instructions. 	<p>WIRE STRIPPING DETAILS</p>							
<p>HOW TO ORDER</p> <p style="font-size: 1.2em; font-weight: bold;">M80 - 4C1 <u>XX</u> 05F1 - <u>XX</u> - 325 - 00 - 000</p> <table border="1" style="width: 100%; border-collapse: collapse;"> <tr> <td style="width: 30%; background-color: #f4a460; color: white; text-align: center;">NO. OF SIGNAL CONTACTS</td> <td style="width: 40%;"></td> <td style="width: 30%; background-color: #f4a460; color: white; text-align: center;">NO. OF POWER CONTACTS</td> </tr> <tr> <td style="background-color: #f4a460; color: white; text-align: center;">02, 04, 06, 08, 12</td> <td></td> <td style="background-color: #f4a460; color: white; text-align: center;">02, 04</td> </tr> </table> <p>Check image chart to confirm Off-The-Shelf sizes available</p>			NO. OF SIGNAL CONTACTS		NO. OF POWER CONTACTS	02, 04, 06, 08, 12		02, 04
NO. OF SIGNAL CONTACTS		NO. OF POWER CONTACTS						
02, 04, 06, 08, 12		02, 04						

All dimensions in mm.

Datamate Power/Signal Connectors

Male Power/Signal Vertical Throughboard

- A selection of stocked Datamate Mix-Tek solder tail standard layouts.
- Choice to suit two PCB thicknesses and two stud lengths.
- Polarized housings.
- Standard Power contacts rated to 20A, signal to 3A.

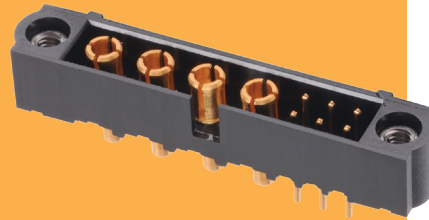

JACKSCREW ONLY

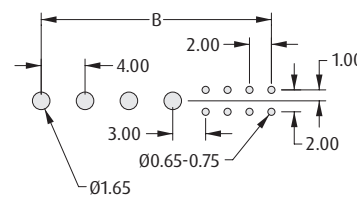
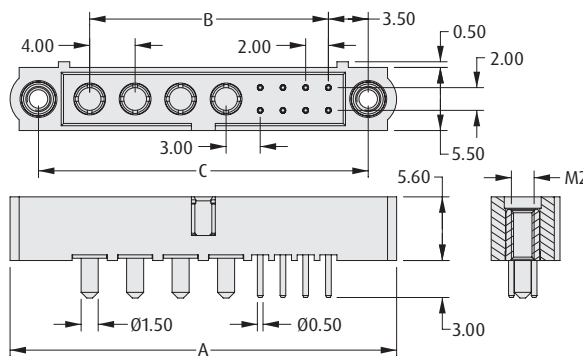

Recommended PC Board Pattern

CALCULATION

A	$B + 13$
B	(No. of Power contacts - 1) x 4 + Total no. of Signal contacts + 1
C	$B + 8$

WITH BOARD MOUNT

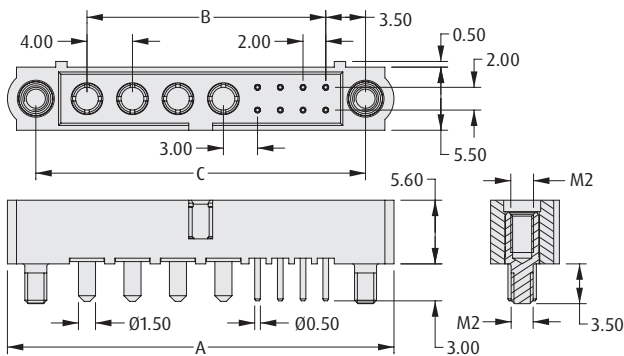

**Board Mount Nut,
2 per connector**

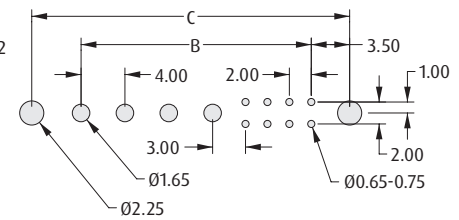
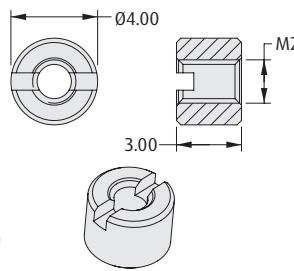

Recommended PC Board Pattern

HOW TO ORDER

M80 - 5T1 XX 05 XX - XX - 331 - 00 - 000

NO. OF SIGNAL CONTACTS

02, 04, 06, 08, 12

NO. OF POWER CONTACTS

02, 04

JACKSCREW

M1	Jackscrew only
M2	With 3.5mm Board Mount stud

Check image chart to confirm Off-The-Shelf sizes available

All dimensions in mm.

Datamate Power/Signal Connectors

Male Power/Signal Horizontal Throughboard

- ❖ A selection of stocked Datamate Mix-Tek solder tail standard layouts.
- ❖ Polarized housings.
- ❖ Standard Power contacts rated to 20A, signal to 3A.

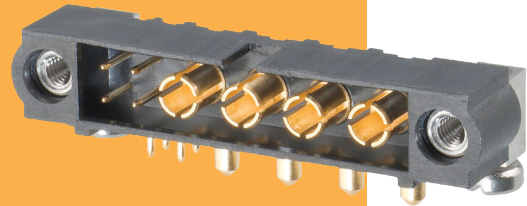

DATAMATE POWER/SIGNAL

SIGNAL AND POWER

CALCULATION

A	$B + 13$
B	$(\text{No. of Power contacts} - 1) \times 4 + \text{Total no. of Signal contacts} + 1$
C	$B + 8$

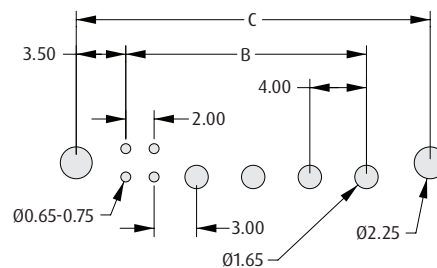
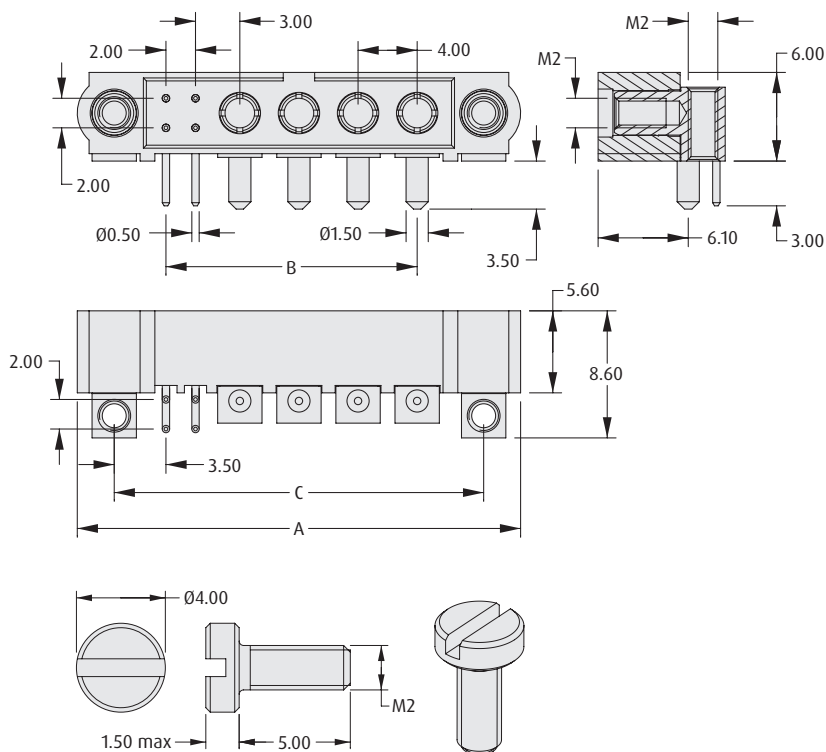

Recommended PC Board Pattern

Board Mount Bolt, 2 per connector

HOW TO ORDER

M80 - 5L1 04 05 M5 - XX - 333 - 00 - 000

NO. OF SIGNAL CONTACTS

04

NO. OF POWER CONTACTS

02, 04

All dimensions in mm.

Datamate Coax Connectors

- Standard high-reliability connectors fitted with coax contacts on 4mm pitch.

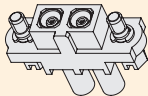
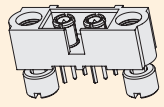
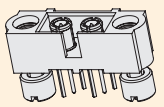
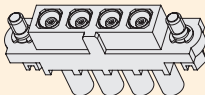
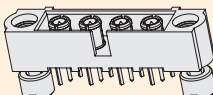
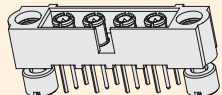
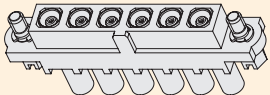
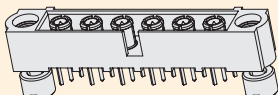
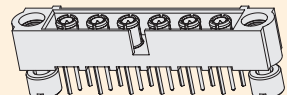
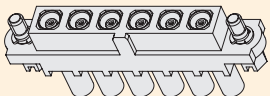
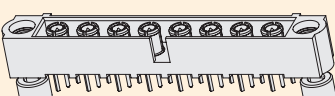
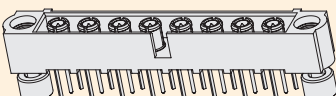
		TYPE		
		Female Cable Connectors - Hex Slotted Jackscrews	Male Vertical 3mm Tail - 3.5mm Board Mount Jackcrew	Male Vertical 4.5mm Tail - 5mm Board Mount Jackcrew
TOTAL NO. OF CONTACTS	2 Coax	 M80-FC305F1-02	 M80-MV311M2-02	 M80-MV312M3-02
	4 Coax	 M80-FC305F1-04	 M80-MV311M2-04	 M80-MV312M3-04
	6 Coax	 M80-FC305F1-06	 M80-MV311M2-06	 M80-MV312M3-06
	8 Coax	 M80-FC305F1-08	 M80-MV311M2-08	 M80-MV312M3-08

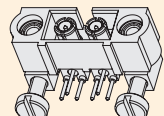
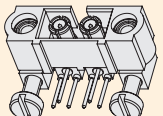
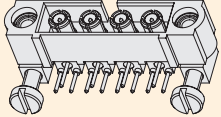
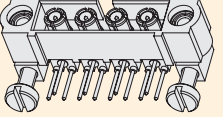
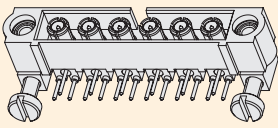
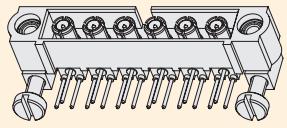
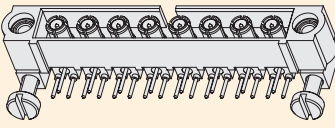
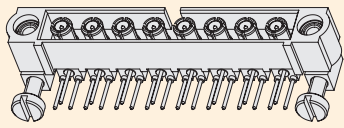
		TYPE		
		Female Cable Assemblies - Hex Slotted Jackscrews	Male Horizontal 3mm Tail - 5mm Board Mount Jackcrew	Male Horizontal 4.5mm Tail - 5mm Board Mount Jackcrew
TOTAL NO. OF CONTACTS	2 Coax	Single Ended (Female to Cut End) M80-FC305F1-02-0150L Double Ended (Female to Female) M80-FC305F1-02-0150F1	 M80-MH313M5-02	 M80-MH314M5-02
	4 Coax	Single Ended (Female to Cut End) M80-FC305F1-04-0150L Double Ended (Female to Female) M80-FC305F1-04-0150F1	 M80-MH313M5-04	 M80-MH314M5-04
	6 Coax	Single Ended (Female to Cut End) M80-FC305F1-06-1050L Double Ended (Female to Female) M80-FC305F1-06-0150F1	 M80-MH313M5-06	 M80-MH314M5-06
	8 Coax	Single Ended (Female to Cut End) M80-FC305F1-08-0150L Double Ended (Female to Female) M80-FC305F1-08-0150F1	 M80-MH313M5-08	 M80-MH314M5-08

Datamate Coax Connectors

Jack (Female) Crimp Kit

- ❖ A selection of stocked jack cable connectors in standard layouts.
- ❖ 6GHz, 50Ω Coax contacts, suitable for RG178 cable.
- ❖ Product supplied as a complete kit; housing with jackscrews assembled, and the applicable number of coax contacts supplied loose, not assembled.
- ❖ Polarized housings.
- ❖ Hexagonal slotted jackscrew style.

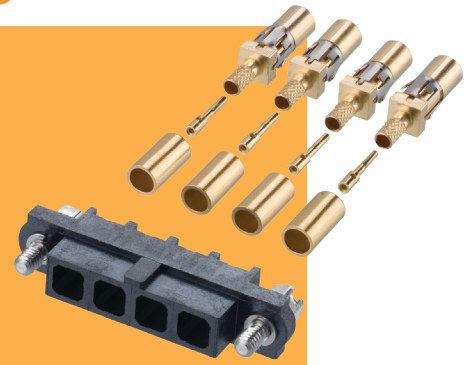

DATAMATE COAX

CABLE	CALCULATION	SPARE COAX CONTACTS						
	<table border="1"> <tr> <td>A</td> <td>$B + 14$</td> </tr> <tr> <td>B</td> <td>$(\text{No. of Coax contacts} - 1) \times 4$</td> </tr> <tr> <td>C</td> <td>$B + 9$</td> </tr> </table>	A	$B + 14$	B	$(\text{No. of Coax contacts} - 1) \times 4$	C	$B + 9$	<div style="border: 1px solid black; padding: 5px; margin-top: 10px; text-align: center;"> ORDER CODE M80-305 </div>
A	$B + 14$							
B	$(\text{No. of Coax contacts} - 1) \times 4$							
C	$B + 9$							
TOOLS	WIRE STRIPPING DETAILS							
<p>Recommended Inner Contact Crimp Tool - Z80-292</p> <p>Positioner for Inner Contact - Z80-291</p> <p>Recommended Outer Sleeve Crimp Tool - Z80-293</p> <p>Contact Removal Tool - Z80-290</p> <p>❖ Instruction sheets available at www.harwin.com/instructions.</p>								
HOW TO ORDER								
M80 - FC 305 F1 - XX								
<table border="1" style="width: 100%;"> <tr> <th colspan="2" style="background-color: #f4a460;">COAX CONTACT TYPE</th> </tr> <tr> <td style="width: 30px; text-align: center;">305</td> <td>Ø2.00mm cable</td> </tr> </table>	COAX CONTACT TYPE		305	Ø2.00mm cable	<table border="1" style="width: 100%;"> <tr> <th style="background-color: #f4a460;">NO. OF COAX CONTACTS</th> </tr> <tr> <td style="text-align: center;">02, 04, 06, 08</td> </tr> </table>	NO. OF COAX CONTACTS	02, 04, 06, 08	
COAX CONTACT TYPE								
305	Ø2.00mm cable							
NO. OF COAX CONTACTS								
02, 04, 06, 08								

All dimensions in mm.

Datamate Coax Connectors

Jack (Female) Cable Assemblies

- A selection of stocked ganged multiport coax cable assemblies in standard layouts (custom also available).
- 6GHz, 50Ω Coax contacts, assembled with RG178 cable.
- Hexagonal slotted jackscrew style.
- Cable assemblies are constructed with Contact A to Contact A, Contact B to Contact B, etc.

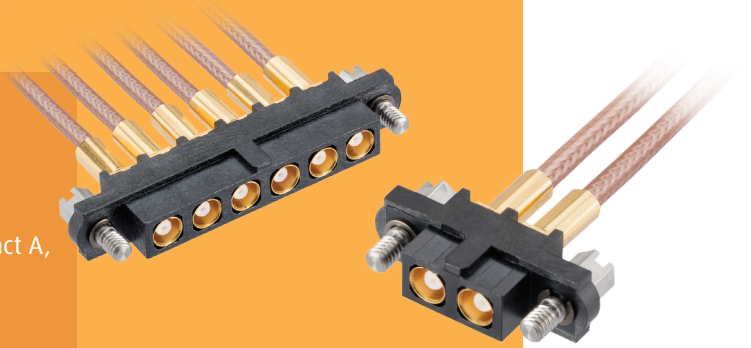

FEMALE SINGLE ENDED

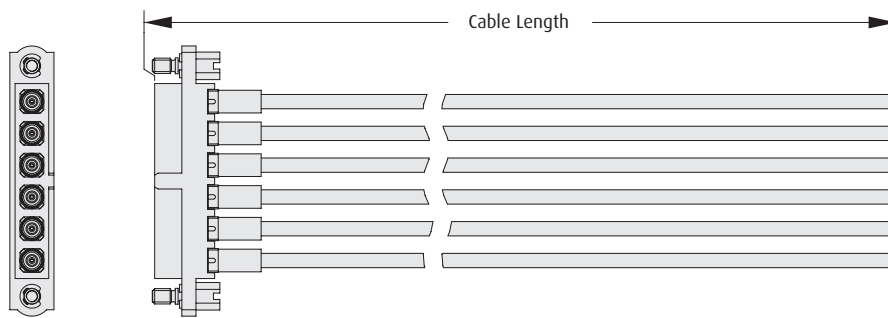

FEMALE - FEMALE

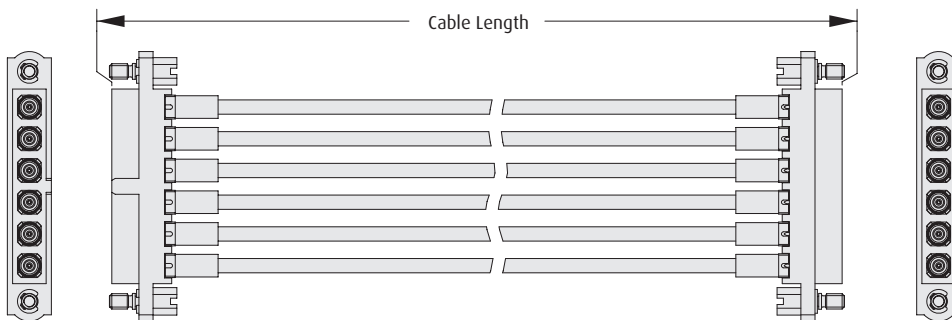

HOW TO ORDER

M80 - FC305F1 - XX - XXXX XX

SERIES CODE

NO. OF POWER CONTACTS

02, 04, 06, 08

TERMINATION - SECOND END

L	Loose cut end
F1	Female connector

CABLE LENGTH

0150	150mm
0300	300mm
0450	450mm
XXXX	XXXXmm

All dimensions in mm.

Datamate Coax Connectors

Plug (Male) Vertical Throughboard

- Stocked coax connectors in vertical orientation, with board-mount jackscrews for added security.
- 6GHz, 50Ω Coax contacts.
- Choice to suit two PCB thicknesses.
- Order board mount nuts separately.
- Screwdriver **Z80-298** available for assembling slotted jackscrew nuts.

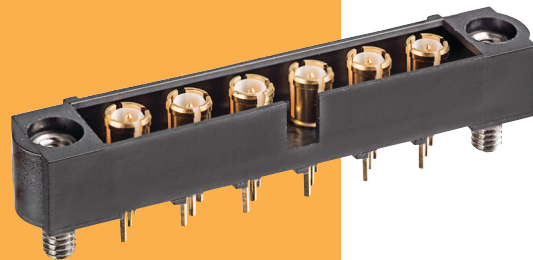

VERTICAL

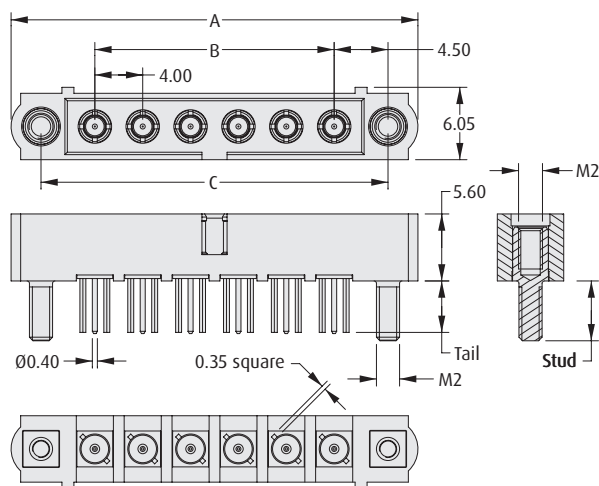

CALCULATION

A	B + 14
B	(No. of Coax contacts - 1) x 4
C	B + 9

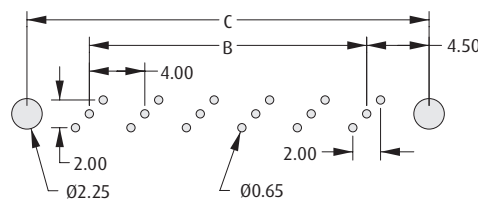

Recommended PCB Board Pattern

HOW TO ORDER

M80 - MV 3XX MX - XX

TYPE	
311M2	3mm Tail with 3.5mm Board Mount Stud
312M3	4.5mm Tail with 5mm Board Mount Stud

NO. OF COAX CONTACTS
02, 04, 06, 08

REQUIRED HARDWARE

Order separately from connector

Slotted Board Mount Nut

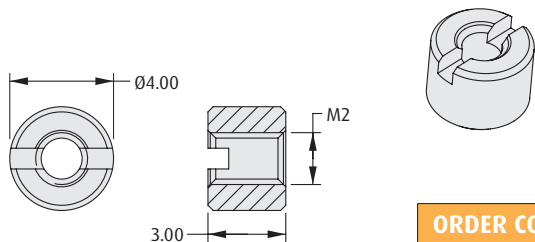

ORDER CODE
M80-2130000B

Hexagonal Board Mount Nut

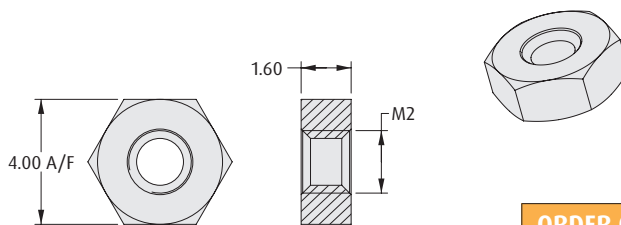

ORDER CODE
M80-2430000B

All dimensions in mm.

Datamate Coax Connectors

Plug (Male) Horizontal Throughboard

- ❖ Stocked coax connectors in horizontal orientation, with board-mount jackscrews for added security.
- ❖ 6GHz, 50Ω Coax contacts.
- ❖ Choice to suit two PCB thicknesses.
- ❖ Order board mount bolts separately.

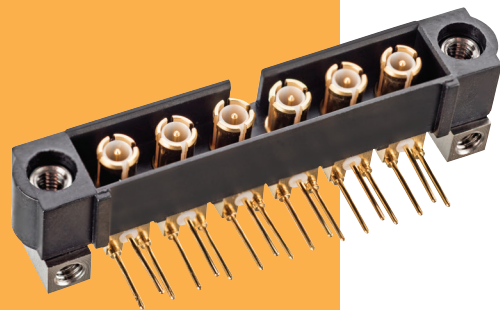

HORIZONTAL

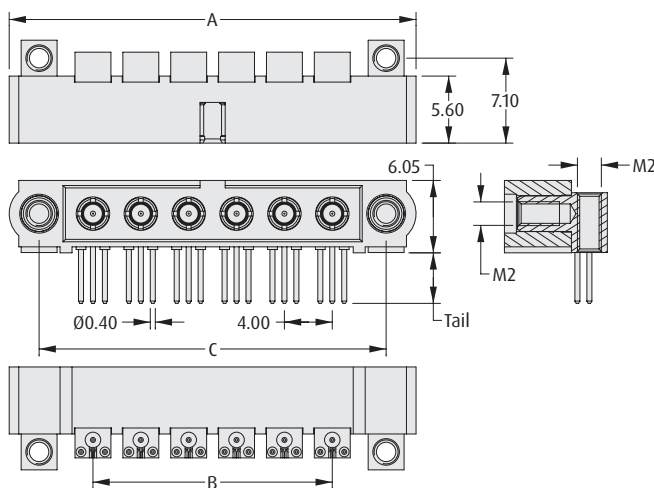

CALCULATION

A	B + 14
B	(No. of Coax contacts - 1) x 4
C	B + 9

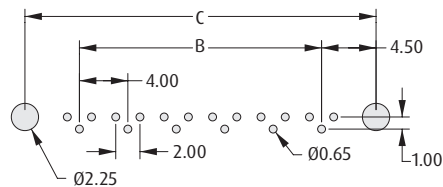

Recommended PCB Board Pattern

HOW TO ORDER

M80 - MH 3XX M5 - XX

TYPE	
313	3mm Tail
314	4.5mm Tail

NO. OF COAX CONTACTS
02, 04, 06, 08

REQUIRED HARDWARE

Order separately from connector

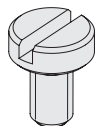
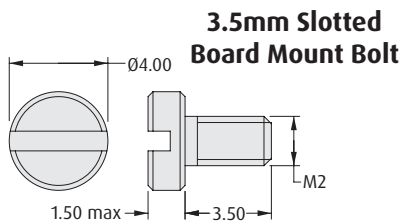

ORDER CODE
M80-2260000B

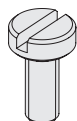
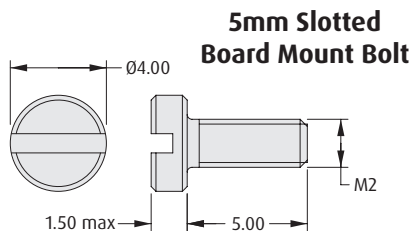

ORDER CODE
M80-2270000B

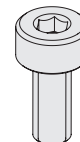
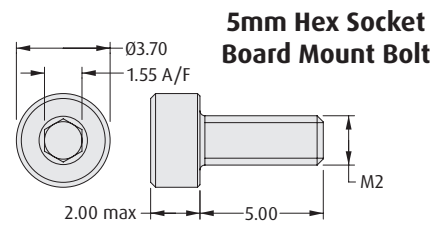

ORDER CODE
M80-2320000B

All dimensions in mm.

Datamate Mix-Tek Housings

- ❖ Housings only for cable connections, suitable for use with all power, high power and coax contacts. Contacts to be ordered separately.

MIXED TECHNOLOGY HOUSINGS - FEMALE, HEX SLOTTED JACKSCREWS				
	2 Power/Coax	3 Power/Coax	4 Power/Coax	6 Power/Coax
2 Signal			M80-263F104-02-00	M80-263F106-02-00
4 Signal			M80-263F104-04-00	
6 Signal	M80-263F102-06-00			
8 Signal	M80-263F102-08-00	M80-263F103-08-00		
12 Signal			M80-263F104-12-00	

POWER/COAX ONLY HOUSINGS - STANDARD GENDER JACKSCREWS				
	Female Hex Slotted floating	Female Hex Socket floating	Female Guide Pin panel mount	Male Internal jackscrew
2 Contact	M80-263F102-00-00	M80-263F202-00-00	M80-263F302-00-00	M80-273M102-00-00
3 Contact	M80-263F103-00-00	M80-263F203-00-00	M80-263F303-00-00	M80-273M103-00-00
4 Contact	M80-263F104-00-00	M80-263F204-00-00	M80-263F304-00-00	M80-273M104-00-00
6 Contact	M80-263F106-00-00	M80-263F206-00-00	M80-263F306-00-00	M80-273M106-00-00
8 Contact	M80-263F108-00-00	M80-263F208-00-00	M80-263F308-00-00	M80-273M108-00-00
10 Contact	M80-263F110-00-00			

POWER/COAX ONLY HOUSINGS				
	REVERSE FIX JACKSCREWS		101LOK	
	Female 5mm panel mount	Male Slotted floating	Female	Male
2 Contact	M80-263F902-00-00	M80-273MA02-00-00	M80-263FC02-00-00	M80-273MC02-00-00
3 Contact	M80-263F903-00-00	M80-273MA03-00-00	M80-263FC03-00-00	M80-273MC03-00-00
4 Contact	M80-263F904-00-00	M80-273MA04-00-00	M80-263FC04-00-00	M80-273MC04-00-00
6 Contact	M80-263F906-00-00	M80-273MA06-00-00	M80-263FC06-00-00	M80-273MC06-00-00
8 Contact	M80-263F908-00-00	M80-273MA08-00-00	M80-263FC08-00-00	M80-273MC08-00-00

Datamate Mix-Tek Housings

Female Mixed Technology Cable Housings

- Female cable housings fitted with floating jackscrews (standard gender), hexagonal slotted heads.
- Compatible with all signal, power and coax female cable contacts.
- Housings only - compatible contacts must be purchased separately.
- Mates with any male mixed-technology connectors with the same signal + power/coax layout.
- For other combinations shown on the Technical Drawing, please consult our Experts at www.harwin.com/contact.

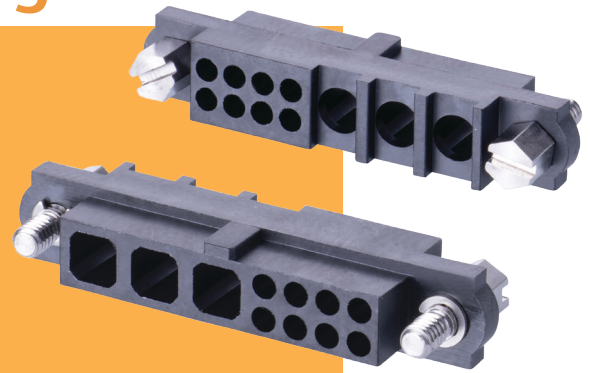

SIGNAL + POWER/COAX

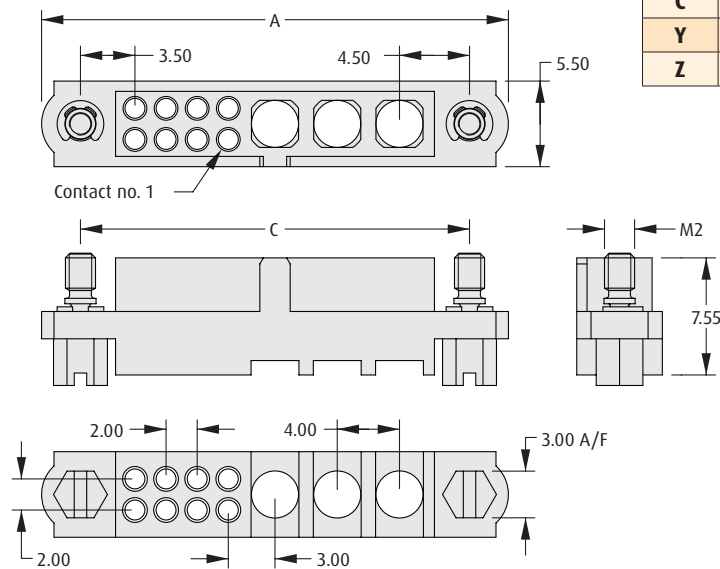

CALCULATION

A	$(4 \times Y) + Z + 10$
C	$(4 \times Y) + Z + 5$
Y	No. of Power/Coax Contact positions
Z	No. of Signal Contact positions

HOW TO ORDER

M80 - 263 F1 XX - XX - 00

SERIES CODE

HOUSING

263 Female

CONTACT POSITION COMBINATIONS

02-06	2 power/coax positions, 6 signal positions
02-08	2 power/coax positions, 8 signal positions
03-08	3 power/coax positions, 8 signal positions
04-02	4 power/coax positions, 2 signal positions
04-04	4 power/coax positions, 4 signal positions
04-12	4 power/coax positions, 12 signal positions
06-02	6 power/coax positions, 2 signal positions

JACKSCREW

F1 Floating Hex Slotted, Standard Gender

All dimensions in mm.

Datamate Mix-Tek Housings

Female Power/Coax Cable Housings

- Female cable housings fitted with floating jackscrews (standard gender).
- Choice of hexagonal slotted or hex socket for the jackscrew head.
- Compatible with all power and coax female cable contacts.
- Housings only - compatible contacts must be purchased separately.
- Mates with any male connectors with the same power/coax layout.
- For other combinations shown on the Technical Drawing, please consult our Experts at www.harwin.com/contact.



DATAMATE MIX-TEK

HEX SLOTTED JACKSCREW

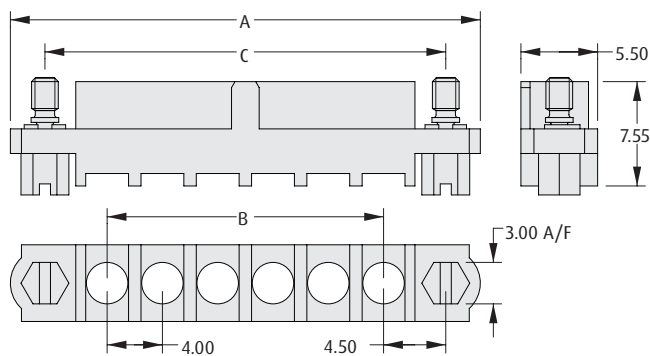

CALCULATION

A	B + 14
B	(No. of contact positions - 1) x 4
C	B + 9

HEX SOCKET JACKSCREW

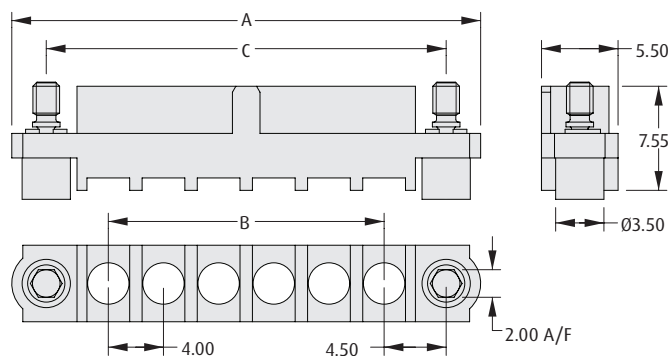

HOW TO ORDER

M80 - 263 XX XX - 00 - 00

SERIES CODE

HOUSING

263 Female

NO. OF POWER/COAX CONTACT POSITIONS

02, 03, 04, 06, 08	All variations
10	F1 jackscrew only

JACKSCREW

F1	Floating Hex Slotted
F2	Floating Hex Socket

All dimensions in mm.

Datamate Mix-Tek Housings

Female Power/Coax Cable Housings - Guide Pin, Reverse Fix

- Female cable housings fitted with panel mount jackscrews.
- Guide Pins are compatible with male standard gender jackscrews.
- Reverse fix panel mount is only compatible with male connectors fitted with reverse fix.
- Compatible with all power and coax female cable contacts.
- Housings only - compatible contacts must be purchased separately.
- For other combinations shown on the Technical Drawing, please consult our Experts at www.harwin.com/contact.



DATAMATE MIX-TEK

GUIDE PIN WITH PANEL MOUNT			SLOTTED NUT
	CALCULATION		❖ Order separately from connector ORDER CODE M80-2130000B
	A	B + 14	HEXAGONAL NUT
REVERSE FIX WITH PANEL MOUNT	B	(No. of contact positions - 1) x 4	
	C	B + 9	
HOW TO ORDER			
M80 - 263 XX XX - 00 - 00			
SERIES CODE			NO. OF POWER/COAX CONTACT POSITIONS
HOUSING			JACKSCREW
263 Female			F3 Guide pin with 5mm panel mount stud
			F9 Reverse fix with 5mm panel mount stud

All dimensions in mm.

Datamate Mix-Tek Housings

Female Power/Coax Cable Housings - 101Lok

- Female cable housings fitted with secure, fast and simple bayonet fixings, no special tooling required.
- Mates with male connectors fitted with 101Lok receptacles.
- Housings only - compatible contacts must be purchased separately.
- Compatible with all power and coax female cable contacts.
- For other combinations shown on the Technical Drawing, please consult our Experts at www.harwin.com/contact.



DATAMATE MIX-TEK

101LOK

CALCULATION

A	B + 14
B	(No. of contact positions - 1) x 4
C	B + 9

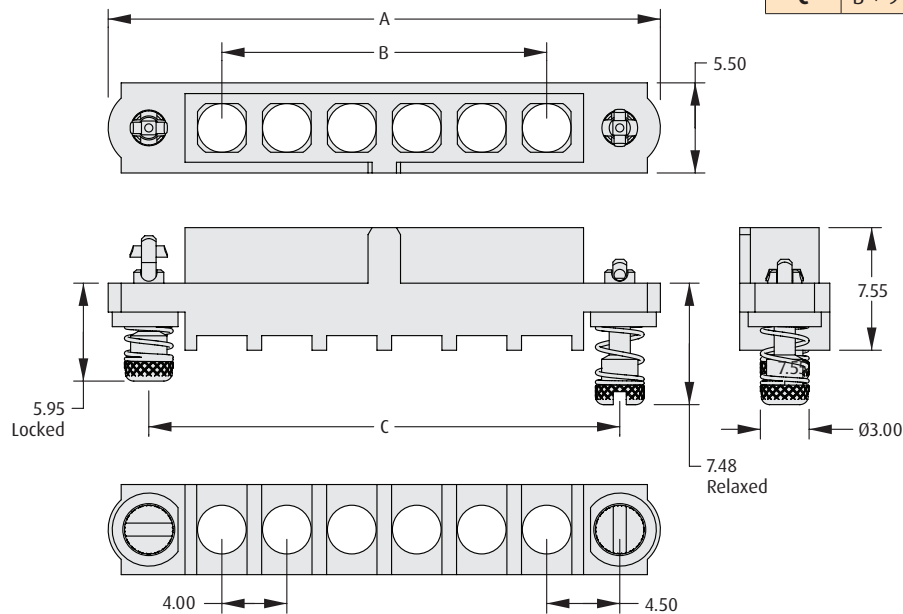

HOW TO ORDER

M80 - 263 FC XX - 00 - 00

SERIES CODE

HOUSING

263 Female

NO. OF POWER/COAX CONTACT POSITIONS

02, 03, 04, 06, 08

JACKSCREW

FC 101Lok fixing

All dimensions in mm.

Datamate Mix-Tek Housings

Male Power/Coax Cable Housings

- ❖ Male cable housings fitted with either internally threaded jackscrews (standard gender) or 101Lok receptacles.
- ❖ Internal threaded jackscrews compatible with standard gender floating jackscrews or guide pins.
- ❖ 101Lok receptacle fixings compatible with 101Lok bayonet female fixings.
- ❖ Housings only - compatible power and coax male contacts must be purchased separately.
- ❖ For other combinations shown on the Technical Drawing, please consult our Experts at www.harwin.com/contact.



INTERNAL THREADED JACKSCREW

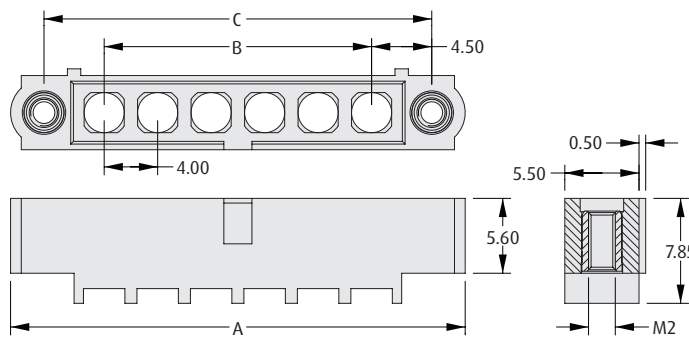

CALCULATION

A	B + 14
B	(No. of contact positions - 1) x 4
C	B + 9

101LOK RECEPTACLE

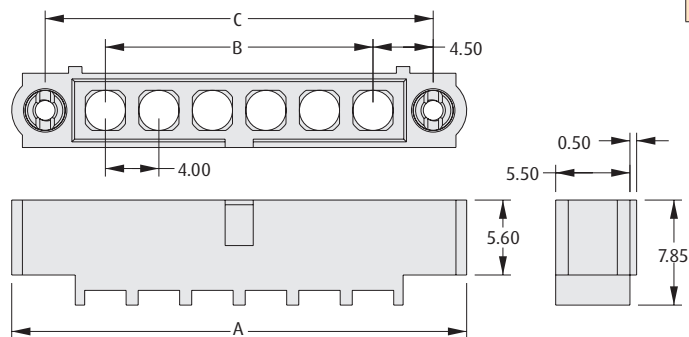

HOW TO ORDER

M80 - 273 XX XX - 00 - 00

SERIES CODE

HOUSING

273 Male

NO. OF POWER/COAX CONTACT POSITIONS

02, 03, 04, 06, 08

JACKSCREW

M1	Internally threaded jackscrew, standard gender
MC	101Lok receptacle fixing

All dimensions in mm.

Datamate Mix-Tek Housings

Male Power/Coax Cable Housings - Reverse Fix

- ❖ Male cable housings fitted with floating slotted jackscrews, reverse fix style.
- ❖ Mates with equivalent layout female connectors fitted with reverse fix jackscrews.
- ❖ Housings only - compatible power and coax male contacts must be purchased separately.
- ❖ For other combinations shown on the Technical Drawing, please consult our Experts at www.harwin.com/contact.

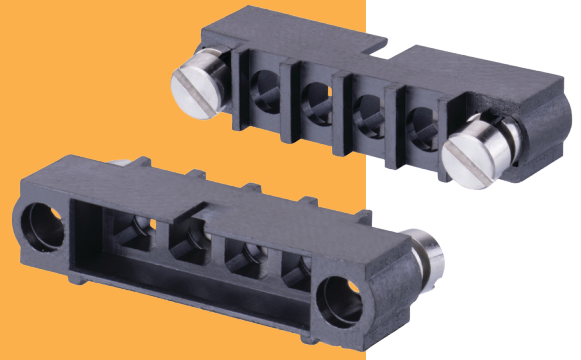

DATAMATE MIX-TEK

REVERSE FIX

CALCULATION

A	B + 14
B	(No. of contact positions - 1) x 4
C	B + 9

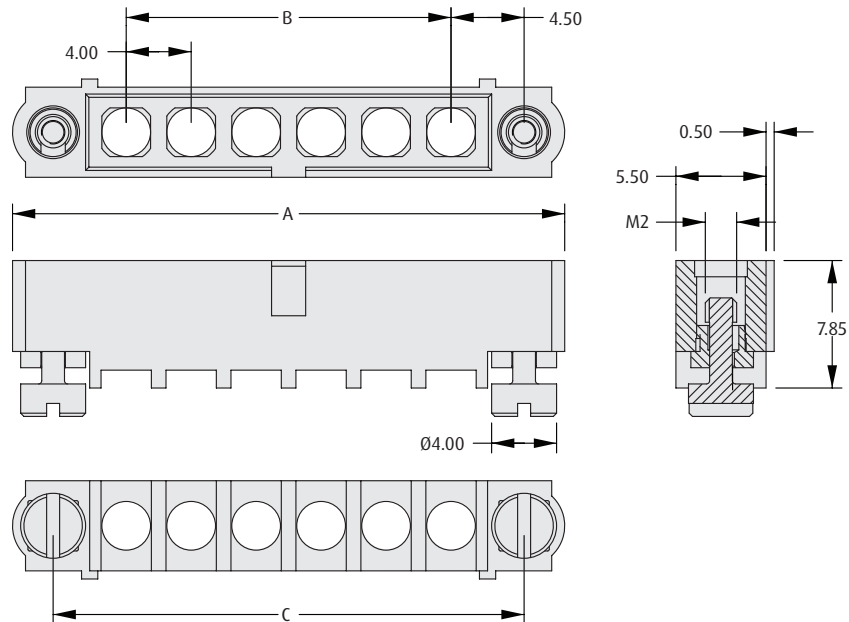

HOW TO ORDER

M80 - 273 MA XX - 00 - 00

SERIES CODE

NO. OF POWER/COAX CONTACT POSITIONS

02, 03, 04, 06, 08

HOUSING

273 Male

JACKSCREW

MA Floating slotted, reverse fix

All dimensions in mm.

Datamate Mix-Tek Cable Contacts

Female Signal Contacts

- Compatible with the signal + power/coax housings. See following pages for power and coax contacts.



DATAMATE MIX-TEK

CRIMP CONTACTS	DUMMY CONTACT												
<p>Large Bore (22 AWG)</p> <p>Small Bore (24 to 28 AWG)</p> <p>Extra Small Bore (28 to 32 AWG)</p>	<div style="border: 1px solid black; padding: 2px; width: fit-content; margin-top: 5px;"> ORDER CODE M80-023 </div>												
	WIRE STRIPPING DETAILS												
	TOOLS												
	<p>Recommended Crimp Tool - M22520/2-01 Positioner - T5747 Contact Insertion/Removal Tool - Z80-280</p> <ul style="list-style-type: none"> Instruction sheets available at www.harwin.com/instructions. 												
HOW TO ORDER													
M80 - OXX 00 XX													
<div style="border: 1px solid black; padding: 2px; width: fit-content; margin-bottom: 10px;"> SERIES CODE </div> <table border="1" style="width: 100%; border-collapse: collapse;"> <thead> <tr> <th style="background-color: #f4a460;">TYPE</th> <th></th> </tr> </thead> <tbody> <tr> <td style="text-align: center;">011</td> <td>Large Bore (22 AWG)</td> </tr> <tr> <td style="text-align: center;">013</td> <td>Small Bore (24-28 AWG)</td> </tr> <tr> <td style="text-align: center;">019</td> <td>Extra Small Bore (28-32 AWG)</td> </tr> </tbody> </table>	TYPE		011	Large Bore (22 AWG)	013	Small Bore (24-28 AWG)	019	Extra Small Bore (28-32 AWG)	<div style="border: 1px solid black; padding: 2px; width: fit-content; margin-top: 10px;"> FINISH </div> <table border="1" style="width: 100%; border-collapse: collapse;"> <tbody> <tr> <td style="text-align: center;">01</td> <td>Gold + Tin</td> </tr> <tr> <td style="text-align: center;">05</td> <td>Gold</td> </tr> </tbody> </table>	01	Gold + Tin	05	Gold
TYPE													
011	Large Bore (22 AWG)												
013	Small Bore (24-28 AWG)												
019	Extra Small Bore (28-32 AWG)												
01	Gold + Tin												
05	Gold												



All dimensions in mm.

Datamate Mix-Tek Cable Contacts

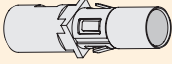
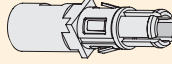
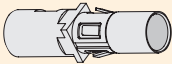
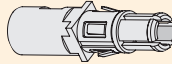
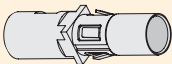
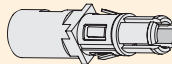
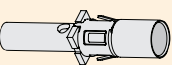
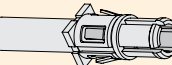
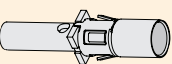
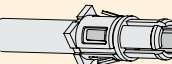
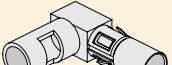
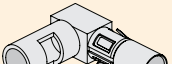
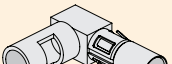
- ❖ Compatible contacts for use with all Mix-Tek cable housings.
- ❖ Female standard power contacts mate with male standard power, female high power with male high power. Standard power contacts do not mate with high power.

STANDARD POWER					
Female	Male	Wire Size	Current Rating	Connection	Wire Strip Length
 M80-325	 M80-335	12 AWG	Up to 20A	Solder	5.00mm min
 M80-326	 M80-336	14 AWG	Up to 15A	Solder	5.00mm min
 M80-327	 M80-337	16 AWG	Up to 10A	Solder	5.00mm min
 M80-328	 M80-338	18 AWG	Up to 8A	Crimp	4.75-5.25mm
 M80-329	 M80-339	20 AWG	Up to 5A	Crimp	4.75-5.25mm
 M80-32A		12 AWG	Up to 20A	Solder	5.00mm min
 M80-32B		14 AWG	Up to 15A	Solder	5.00mm min
 M80-32C		16 AWG	Up to 10A	Solder	5.00mm min

HIGH POWER

 M80-PF5	 M80-PM5	10 AWG	Up to 40A	Solder	5.00mm min
--	--	--------	-----------	--------	------------

TOOLS

Recommended Crimp Tool - Z80-294
Positioner - Z80-295
Contact Removal Tool - Z80-290

- ❖ Crimp Tool and Positioner required only for the Crimp contacts. No special tool is required for connecting wire to the solder contacts, other than standard soldering equipment.
- ❖ Instruction sheets available at www.harwin.com/instructions.

Datamate Mix-Tek Cable Contacts

- ❖ Compatible contacts for use with all Mix-Tek cable housings.
- ❖ Straight coax contacts can mate with right-angle coax contacts.

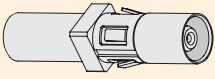
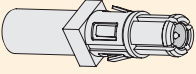
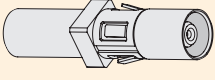
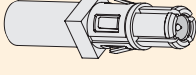
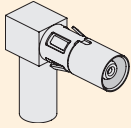
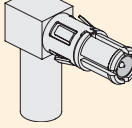
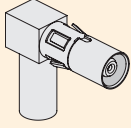
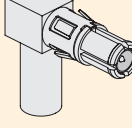
COAX					
Female	Male	Coax Size	Coax Type	Connection	Wire Strip Length
 M80-305	 M80-315	Ø2.00mm	RG178	Crimp	See Figure 1
 M80-307	 M80-317	Ø2.70mm	RG174 RG179 RG316	Crimp	See Figure 1
 M80-308	 M80-318	Ø2.00mm	RG178	Crimp	See Figure 2
 M80-309	 M80-319	Ø2.70mm	RG174 RG179 RG316	Crimp	See Figure 2

TOOLS

Recommended Inner Contact Crimp Tool - Z80-292
Positioner for Inner Contact - Z80-291
Recommended Outer Sleeve Crimp Tool - Z80-293
Contact Removal Tool - Z80-290

❖ Instruction sheets available at www.harwin.com/instructions.

WIRE STRIPPING DETAILS

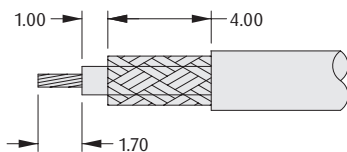

Figure 1

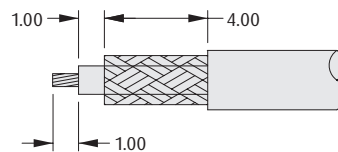

Figure 2

All dimensions in mm.

Datamate Mix-Tek Connectors

Metal Backshell Accessories

- ❖ Metal Backshells that can be used with any female cable connector (up to 12AWG), or male connectors with board mount jackscrews.
- ❖ Female backshells come with jackscrews - any existing jackscrews can be removed by removing the e-clip.
- ❖ Suitable for new designs, or in-production addition to enhance existing designs.



DATAMATE MIX-TEK

PART NUMBERING SYSTEM

M80 - 9 XX XX 02

SERIES CODE

FINISH

02 Nickel

TYPE

06	Male
45	Female with Slotted Jackscrews
46	Female with Hex Socket Jackscrews

EQUIVALENT NO. OF SIGNAL CONTACTS	NO. OF POWER ONLY OR COAX ONLY CONTACTS	NO. OF CONTACTS IN POWER/SIGNAL COMBINATION
08	2 contacts	-
10	-	2 Power, 2 Signal
12	3 contacts	2 Power, 4 Signal
14	-	2 Power, 6 Signal
16	4 contacts	2 Power, 8 Signal
18	-	4 Power, 2 Signal
20	5 contacts	2 Power, 12 Signal or 4 Power, 4 Signal
22	-	4 Power, 6 Signal
24	6 contacts	4 Power, 8 Signal
28	7 contacts	4 Power, 12 Signal
32	8 contacts	-
36	9 contacts	-
40	10 contacts	-
44	11 contacts	-
48	12 contacts	-

All dimensions in mm.

Datamate Mix-Tek Connectors

Female Metal Backshell

- ❖ Supplied as an accessory kit, including metal backshell, e-clips and the applicable jackscrews.
- ❖ To be used with the appropriate size of Female Cable connector kit without jackscrews (existing jackscrews can be removed).
- ❖ Gives 360 degree shielding when used with conductive braid and mated to a compatible male connector with metal backshell.
- ❖ Instruction sheets available at www.harwin.com/instructions.



DATAMATE MIX-TEK

FEMALE		CALCULATION					
<p>1 x Metal Backshell</p>		A	$B + 16.2$				
		B	Equivalent no. of contacts - 2				
		C	$B + 7$				
		D	$B + 0.8$				
E-CLIP TOOL		BAND-IT TIE					
<p>❖ For assembling E-Clips supplied with kit.</p> <p>ORDER CODE Z80-300</p>		<p>❖ For fixing braid to rear collar (requires Tie Dex II A30199 Micro Band tool).</p> <p>ORDER CODE</p> <table border="1"> <tr> <td>M80-9470000</td> <td>Length = 206.8mm</td> </tr> <tr> <td>M80-9480000</td> <td>Length = 362.0mm</td> </tr> </table>		M80-9470000	Length = 206.8mm	M80-9480000	Length = 362.0mm
M80-9470000	Length = 206.8mm						
M80-9480000	Length = 362.0mm						
HOW TO ORDER							
M80 - 94 X XX 02							
<p>SERIES CODE</p>		<p>FINISH</p> <table border="1"> <tr> <td>02</td> <td>Nickel</td> </tr> </table>		02	Nickel		
02	Nickel						
<p>TYPE</p> <table border="1"> <tr> <td>5</td> <td>With Slotted Jackscrews</td> </tr> <tr> <td>6</td> <td>With Hex Socket Jackscrews</td> </tr> </table>		5	With Slotted Jackscrews	6	With Hex Socket Jackscrews	<p>EQUIVALENT NO. OF SIGNAL CONTACTS</p> <p>08, 10, 12, 14, 16, 18, 20, 22, 24, 28, 32, 36, 40, 44, 48</p>	
5	With Slotted Jackscrews						
6	With Hex Socket Jackscrews						

All dimensions in mm.

Datamate Mix-Tek Connectors

Male Metal Backshell

- ❖ Supplied as an accessory, to be used with existing male connectors.
- ❖ Can be fitted to either male vertical PCB connectors with board mount, or male cable connectors with panel mount jackscrews.
- ❖ Gives 360 degree shielding when mounted to a conductive panel and mated to a compatible female connector with metal backshell.



DATAMATE MIX-TEK

MALE		CALCULATION	
A	$B + 13.7$	B	Equivalent no. of contacts - 2
C	$B + 7$	C	$B + 7$
D	$B + 2.8$	D	$B + 2.8$

HOW TO ORDER

M80 - 906 XX 02

SERIES CODE	FINISH
M80 - 906	02 Nickel

EQUIVALENT NO. OF SIGNAL CONTACTS
08, 10, 12, 14, 16, 18, 20, 22, 24, 28, 32, 36, 40, 44, 48

All dimensions in mm.

Datamate J-Tek Specification

DATAMATE J-TEK

Materials

Housings:	Glass-filled thermoplastic UL94V-0
Female contacts	
Standard J-Tek:	Brass shell, with Beryllium Copper inner contact
T-Contact:	Beryllium Copper
Male contacts:	Copper alloy
Finish:	See individual pages

Electrical

Current - Standard J-Tek

Individual contacts in isolation:	3.3A max (at 25°C) 2.6A max (at 85°C)
All contacts simultaneously:	3.0A max (at 25°C) 2.2A max (at 85°C)
Flex Circuit Assembly:	1.0A max per track (at 25°C)

Current - T-Contact

Individual contacts in isolation:	8.5A max (at 25°C) 6.5A max (at 85°C)
All contacts simultaneously:	3.5A max (at 25°C) 2.6A max (at 85°C)

Working voltage

At sea level 1013 mbar: 800V DC or AC peak

Voltage proof

At sea level 1013 mbar: 1,200V DC or AC peak

Contact resistance

Initial:	20mΩ max
After conditioning:	25mΩ max

Insulation resistance

Initial:	1,000MΩ min
After conditioning:	100MΩ min

Mechanical

Durability

Standard J-Tek:	500 operations
T-Contact:	1,000 operations

Insertion force (max)

Standard J-Tek:	2.8N
T-Contact:	4.0N

Withdrawal force (min)

Standard J-Tek:	0.2N
T-Contact:	0.5N

Signal crimp accommodation:

22 AWG to 32 AWG
BS 3G 210 Type A, MIL-W-16878

Environmental

Environmental classification: 55/125/56 days at 95% RH

Operational temperature: -55°C to +125°C

*Vibration sensitivity

Standard J-Tek:	10Hz to 2000Hz, 0.75mm, 98m/s ² (10G), duration 6 hours
T-Contact:	10Hz to 2000Hz, 0.75mm, 390m/s ² (40G), duration 6 hours

*Bump severity:

390m/s² (40G), 4000 ±10 bumps

*Shock severity:

981m/s² (100G) for 6ms

*Acceleration severity:

490m/s² (50G)

* Tested with connectors with Jackscrews.

Pin Numbering

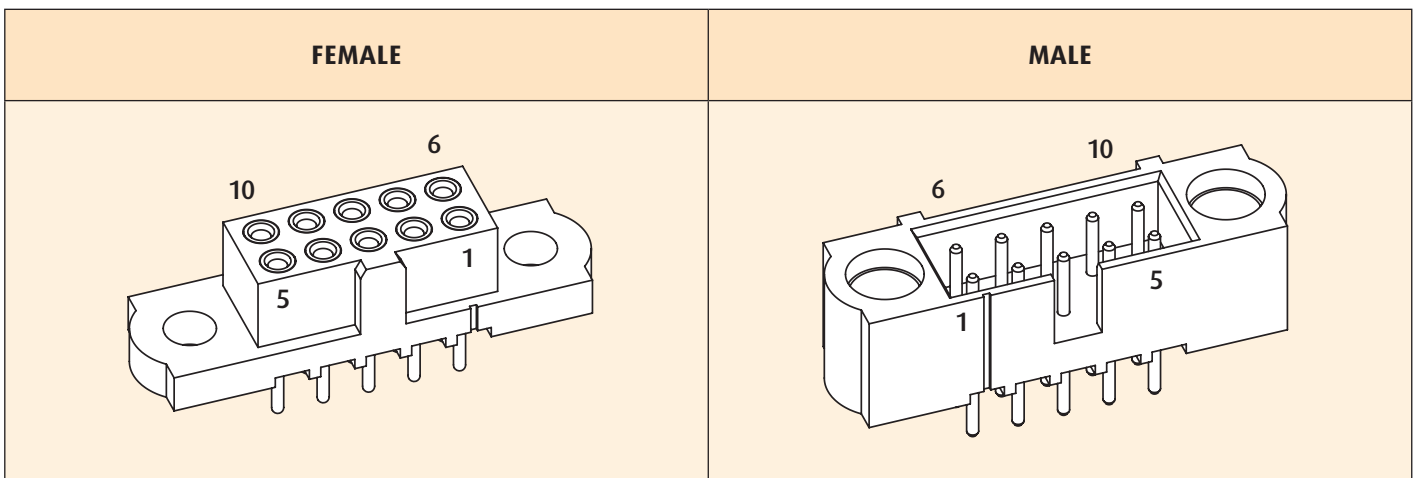

All dimensions in mm.

Datamate J-Tek Mating Profiles

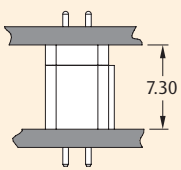
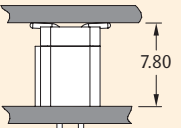
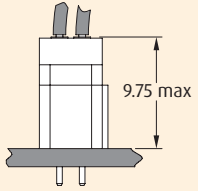
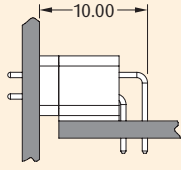
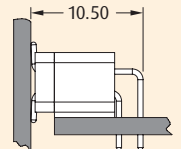
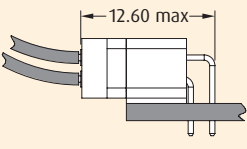
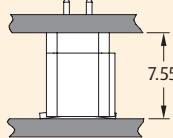
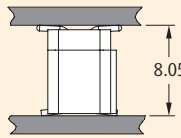
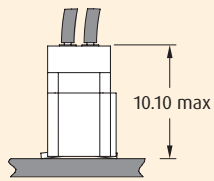
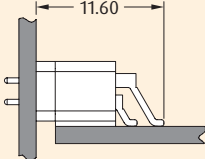
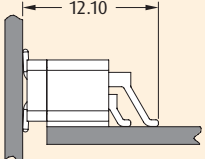
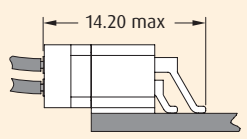
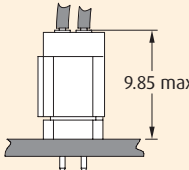
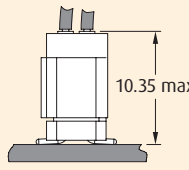
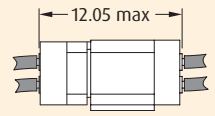
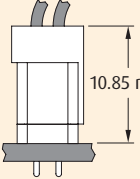
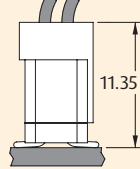
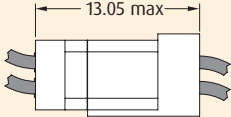
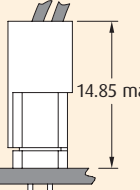
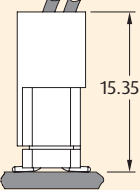
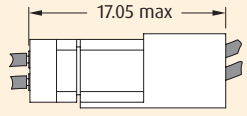
		FEMALE		
		VERTICAL THROUGHBOARD	VERTICAL SMT	CRIMP
MALE	VERTICAL THROUGHBOARD			
	HORIZONTAL THROUGHBOARD			
	VERTICAL SMT			
	HORIZONTAL SMT			
	CRIMP			
	CRIMP 1mm EXTENDED WALL			
	CRIMP 5mm EXTENDED WALL			

All dimensions in mm.

Datamate J-Tek Mating Profiles

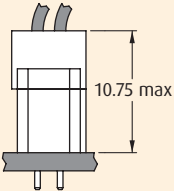
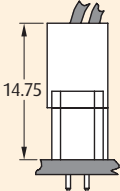
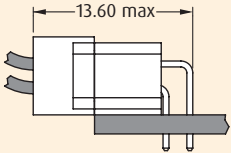
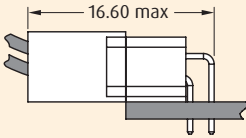
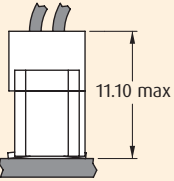
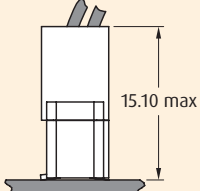
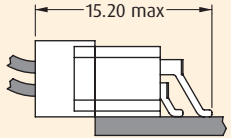
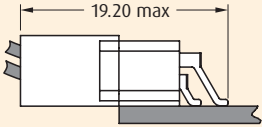
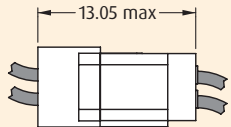
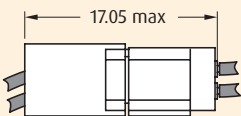
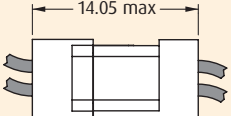
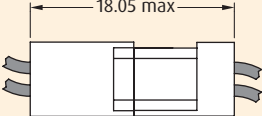
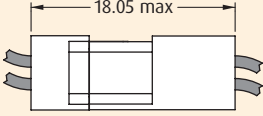
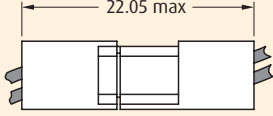
		FEMALE	
		CRIMP 1mm EXTENDED WALL	CRIMP 5mm EXTENDED WALL
MALE	VERTICAL THROUGH-BOARD		
	HORIZONTAL THROUGH-BOARD		
	VERTICAL SMT		
	HORIZONTAL SMT		
	CRIMP		
	CRIMP 1mm EXTENDED WALL		
	CRIMP 5mm EXTENDED WALL		

All dimensions in mm.

Datamate J-Tek Connectors

Female Vertical Throughboard

- ❖ Fully shrouded contacts.
- ❖ Polarized housings.
- ❖ Mates with all Datamate J-Tek male connectors with compatible jackscrews.

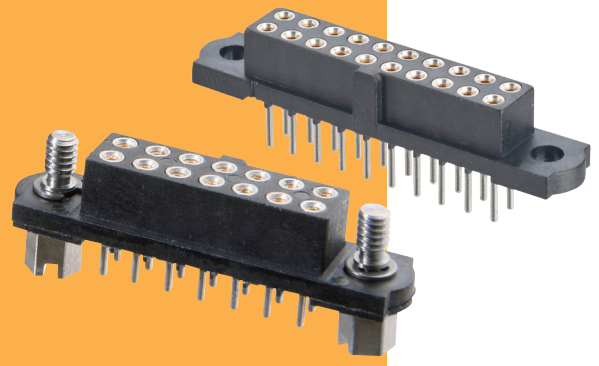

DATAMATE J-TEK

WITHOUT JACKSCREWS

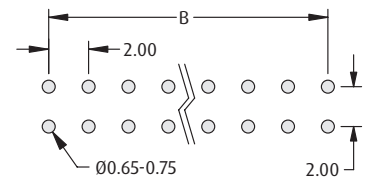
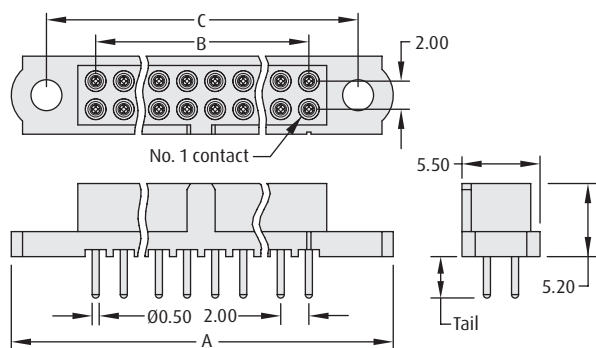

Recommended PC Board Pattern

CALCULATION

A	B + 12
B	Total no. of contacts - 2
C	B + 7

WITH JACKSCREWS

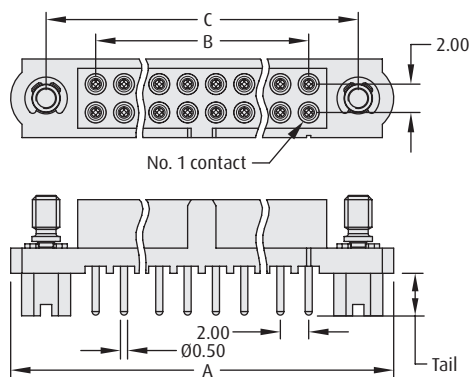

Hex Slotted Jackscrew

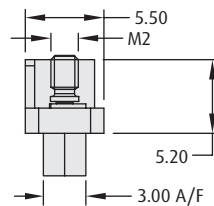

Hex Socket Jackscrew

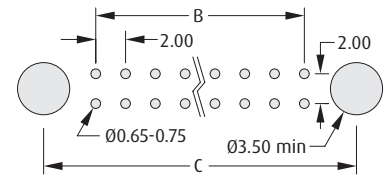
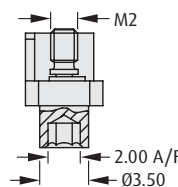

Recommended PC Board Pattern

HOW TO ORDER

M80 - 4 X X XX XX

SERIES CODE

0	With Hex Slotted Jackscrews
1	Without Jackscrews
2	With Hex Socket Jackscrews

0	3mm Tails
1	4.5mm Tails

FINISH

05	Gold
42	Gold + Tin

TOTAL NO. OF CONTACTS

04, 06, 08, 10, 12, 14, 20, 26, 34, 42, 50

All dimensions in mm.

Datamate J-Tek Connectors

Female Vertical Throughboard, Guide Pin, 101Lok

- Guide pin style includes board mount fixing, and mates with Datamate J-Tek male connectors with compatible jackscrews.
- 101Lok fixing gives secure, fast and simple mating; no special tooling required. Just a simple 101-degree turn is required to fix the connectors together.
- 101Lok style mates with Datamate J-Tek male connectors with compatible 101Lok fixings.

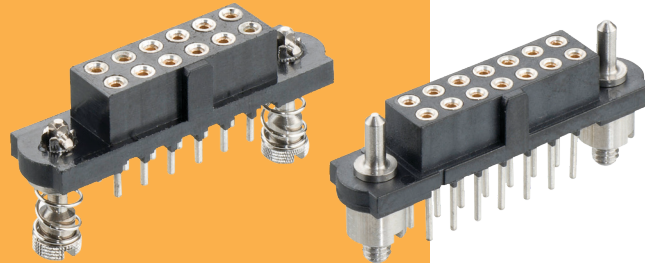

DATAMATE J-TEK

GUIDE PIN JACKSCREWS

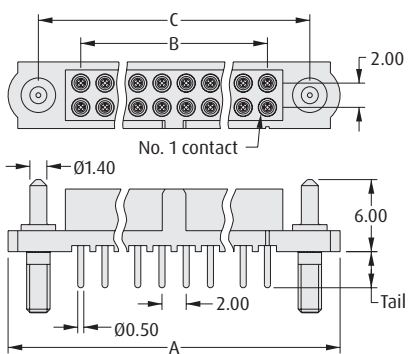

Board Mount Nut, 2 per connector

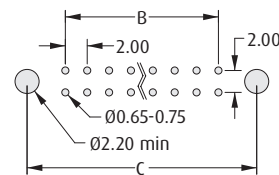
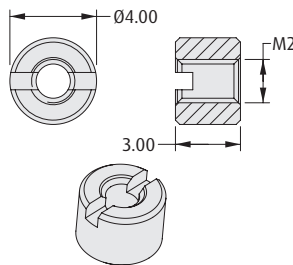

Recommended PC Board Pattern

CALCULATION

A	B + 12
B	Total no. of contacts - 2
C	B + 7

101LOK

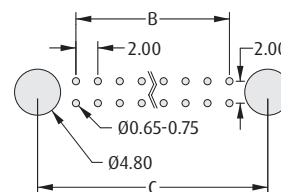
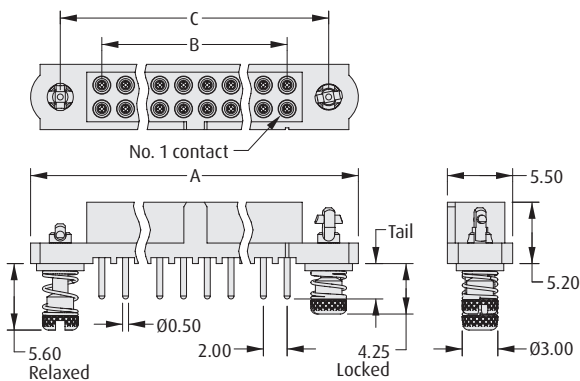

Recommended PC Board Pattern

HOW TO ORDER

M80 - 4 TX XX XX FX

SERIES CODE

TYPE

T1	3mm Tails
T2	4.5mm Tails

TOTAL NO. OF CONTACTS

04, 06, 08, 10, 12, 14, 20, 26, 34, 42, 50

JACKSCREW

F3	Guide Pin
FD	101Lok

FINISH

05	Gold
42	Gold + Tin

All dimensions in mm.

Datamate J-Tek Connectors

Female Vertical Throughboard Reverse Fix

- ❖ Fully shrouded contacts.
- ❖ Polarized housings.
- ❖ Includes board mount fixing.
- ❖ Mates with male Datamate J-Tek connectors with compatible Reverse Fix jackscrews.



DATAMATE J-TEK

REVERSE FIX

CALCULATION

A	$B + 12$
B	Total no. of contacts - 2
C	$B + 7$

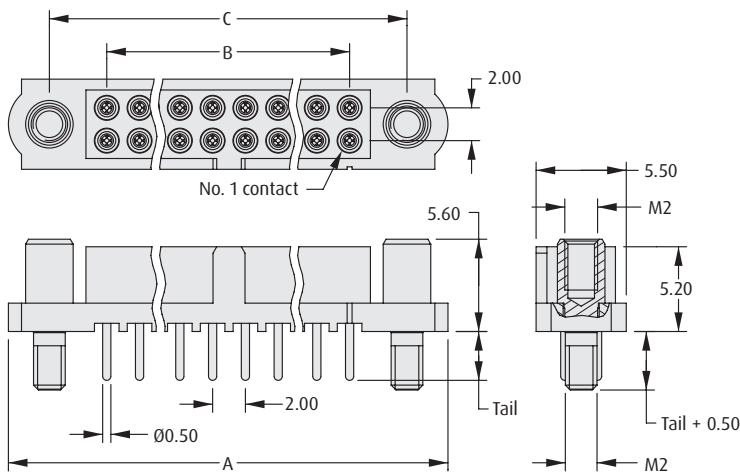

Board Mount Nut, 2 per connector

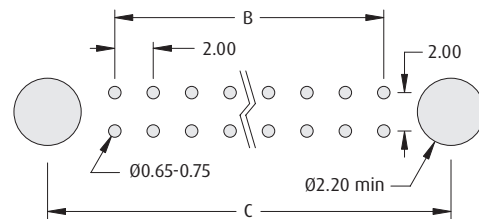
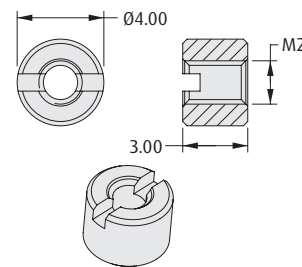

Recommended PC Board Pattern

HOW TO ORDER

M80 - 40 X XX XX

SERIES CODE

TYPE

5	3mm Tails
6	4.5mm Tails

FINISH

05	Gold
42	Gold + Tin

TOTAL NO. OF CONTACTS

04, 06, 08, 10, 12, 14, 20, 26, 34, 42, 50

All dimensions in mm.

Datamate J-Tek Connectors

Female Vertical Surface Mount

- Mates with all Datamate J-Tek male connectors with compatible jackscrews.
- Gull wing SMT tails simplify inspection process.

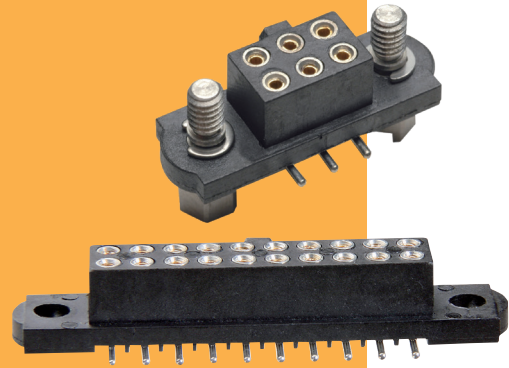

DATAMATE J-TEK

WITHOUT JACKSCREWS

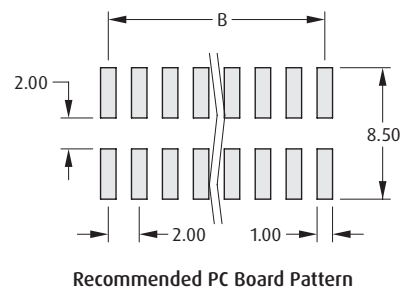
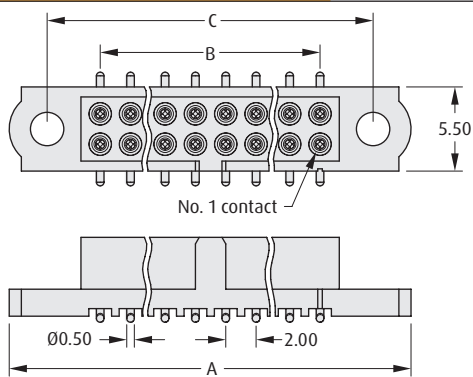

CALCULATION

A	$B + 12$
B	Total no. of contacts - 2
C	$B + 7$

WITH JACKSCREWS

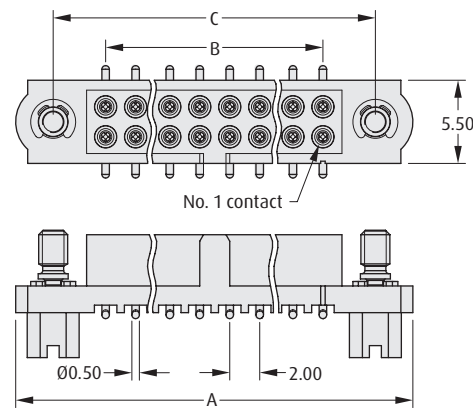

Hex Slotted Jackscrew

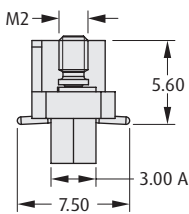

Hex Socket Jackscrew

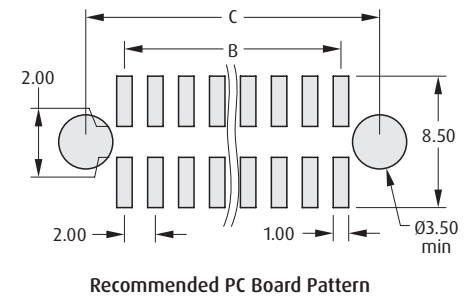
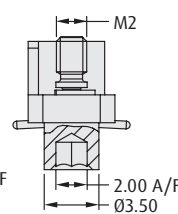

HOW TO ORDER

M80 - 4 X 2 XX XX

SERIES CODE

TYPE

0	With Hex Slotted Jackscrews
1	Without Jackscrews
2	With Hex Socket Jackscrews

FINISH

05	Gold
42	Gold + Tin

TOTAL NO. OF CONTACTS

04, 06, 08, 10, 12, 14, 20, 26, 34, 42, 50

All dimensions in mm.

Datamate J-Tek Connectors

Female Vertical Surface Mount Guide Pin, 101Lok

- Guide pin style includes board mount fixing, and mates with Datamate J-Tek male connectors with compatible jackscrews.
- 101Lok fixing gives secure, fast and simple mating; no special tooling required. Just a simple 101-degree turn is required to fix the connectors together.
- 101Lok style mates with Datamate J-Tek male connectors with compatible 101Lok fixings.

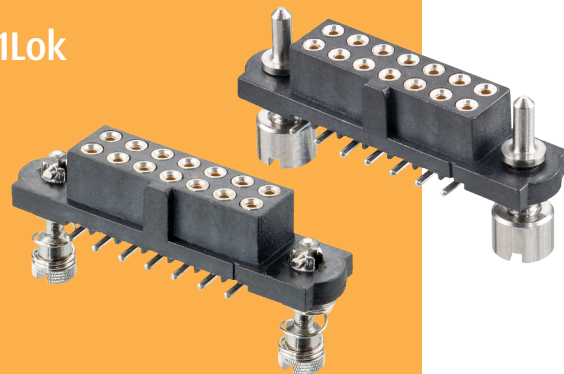

DATAMATE J-TEK

GUIDE PIN JACKSCREWS

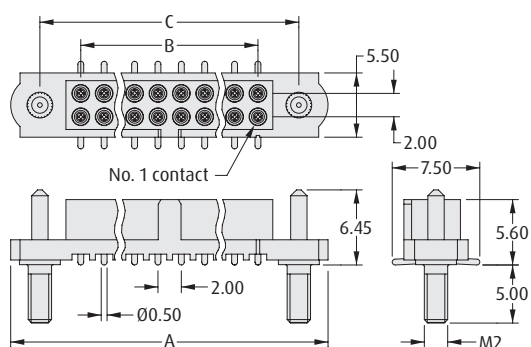

Board Mount Nut, 2 per connector

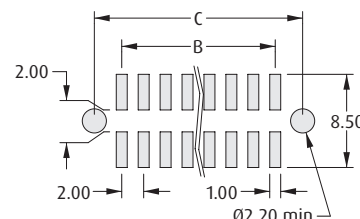
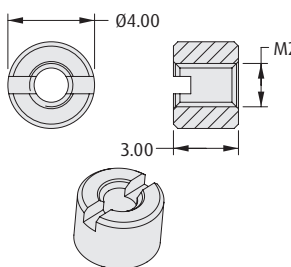

Recommended PC Board Pattern

CALCULATION

A	B + 12
B	Total no. of contacts - 2
C	B + 7

101LOK

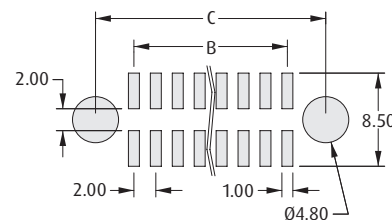
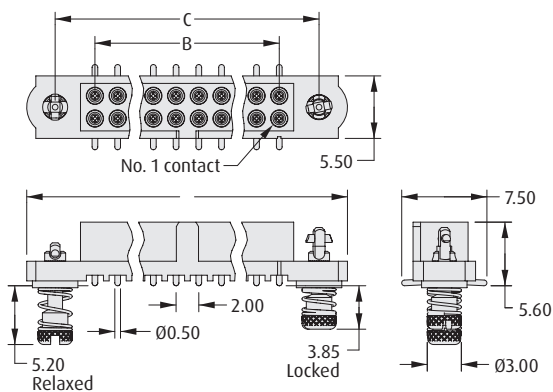

Recommended PC Board Pattern

HOW TO ORDER

M80 - 4S1 XX XX FX

SERIES CODE

TOTAL NO. OF CONTACTS

04, 06, 08, 10, 12, 14, 20, 26, 34, 42, 50

JACKSCREW

F3	Guide Pin
FD	101Lok

FINISH

05	Gold
42	Gold + Tin

All dimensions in mm.

Datamate J-Tek Connectors

Female Vertical Surface Mount Reverse Fix

- Fully shrouded contacts.
- Polarized housings.
- Includes Board Mount fixing.
- Mates with male Datamate J-Tek connectors with compatible Reverse Fix jackscrews.
- Washers are supplied loose, and are to be fitted between the PCB and the housing, around the board mount studs.

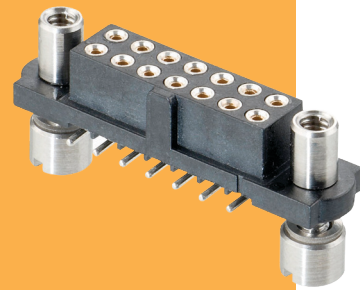

DATAMATE J-TEK

REVERSE FIX

CALCULATION

A	B + 12
B	Total no. of contacts - 2
C	B + 7

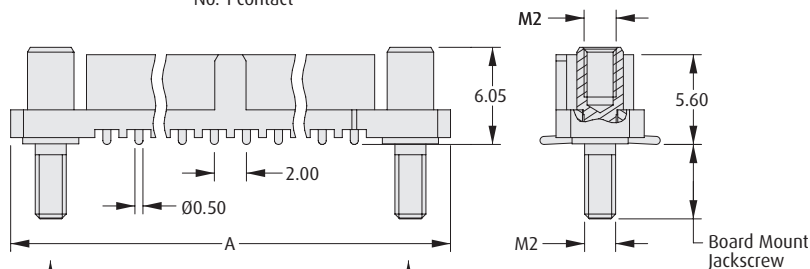
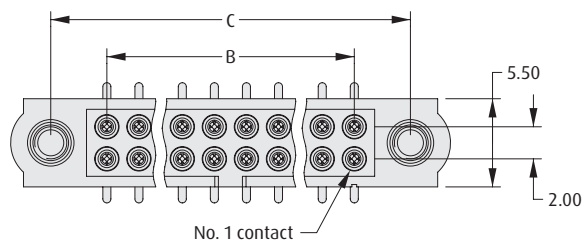

Board Mount Nut, 2 per connector

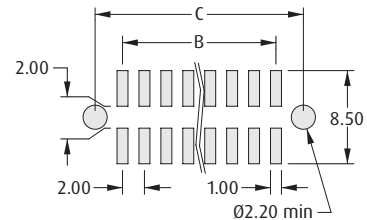
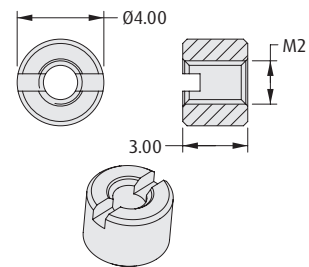

Recommended PC Board Pattern

HOW TO ORDER

M80 - 4S1 XX XX FX

SERIES CODE

TOTAL NO. OF CONTACTS

04, 06, 08, 10, 12, 14, 20, 26, 34, 42, 50

TYPE

F8	3.5mm Board Mount Jackscrew
F9	5mm Board Mount Jackscrew

FINISH

05	Gold
42	Gold + Tin

All dimensions in mm.

Datamate J-Tek Connectors

Female Crimp Kit

- ❖ Part numbers are for a complete kit of a housing and the applicable number of contacts.
- ❖ Jackscrews are assembled where specified.
- ❖ Crimp contacts are rear insertable.
- ❖ Version also available for 28 – 32 AWG cable – see the following page.
- ❖ Spare contacts are available.

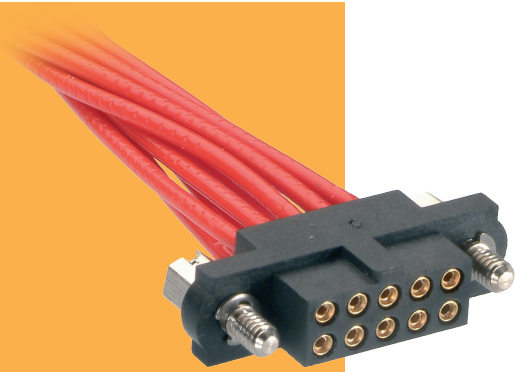

DATAMATE J-TEK

WITHOUT JACKSCREWS		WITH JACKSCREWS																	
		<table border="1"> <thead> <tr> <th colspan="2">CALCULATION</th> </tr> </thead> <tbody> <tr> <td>A</td> <td>B + 12</td> </tr> <tr> <td>B</td> <td>Total no. of contacts - 2</td> </tr> <tr> <td>C</td> <td>B + 7</td> </tr> </tbody> </table>		CALCULATION		A	B + 12	B	Total no. of contacts - 2	C	B + 7								
CALCULATION																			
A	B + 12																		
B	Total no. of contacts - 2																		
C	B + 7																		
<p>TOOLS</p> <p>Recommended Crimp Tool – M22520/2-01 Positioner – T5747 Contact Insertion/Removal Tool – Z80-280</p> <ul style="list-style-type: none"> ❖ Spare and pre-cabled contacts shown on following pages. ❖ Instruction sheets available at www.harwin.com/instructions. 		<p>WIRE STRIPPING DETAILS</p>																	
HOW TO ORDER																			
<p>SERIES CODE</p> <table border="1"> <thead> <tr> <th>LARGE BORE (22 AWG)</th> <th>SMALL BORE (24-28 AWG)</th> <th></th> </tr> </thead> <tbody> <tr> <td>470</td> <td>471</td> <td>Without Jackscrews</td> </tr> <tr> <td>460</td> <td>461</td> <td>With Hex Slotted Jackscrews</td> </tr> <tr> <td>480</td> <td>481</td> <td>With Hex Socket Jackscrews</td> </tr> </tbody> </table>		LARGE BORE (22 AWG)	SMALL BORE (24-28 AWG)		470	471	Without Jackscrews	460	461	With Hex Slotted Jackscrews	480	481	With Hex Socket Jackscrews	<p>FINISH</p> <table border="1"> <tbody> <tr> <td>05</td> <td>Gold</td> </tr> <tr> <td>42</td> <td>Gold + Tin</td> </tr> </tbody> </table>		05	Gold	42	Gold + Tin
LARGE BORE (22 AWG)	SMALL BORE (24-28 AWG)																		
470	471	Without Jackscrews																	
460	461	With Hex Slotted Jackscrews																	
480	481	With Hex Socket Jackscrews																	
05	Gold																		
42	Gold + Tin																		
		<p>TOTAL NO. OF CONTACTS</p> <p>04, 06, 08, 10, 12, 14, 20, 26, 34, 42, 50</p>																	

All dimensions in mm.

Datamate J-Tek Connectors

Female Crimp Kit - Extra Small Bore

- Part numbers are for a complete kit of a housing and the applicable number of contacts.
- Jackscrews are assembled where specified.
- Crimp contacts are rear insertable.
- Versions also available for 22 - 28 AWG cable - see the previous page.
- Spare contacts are available.

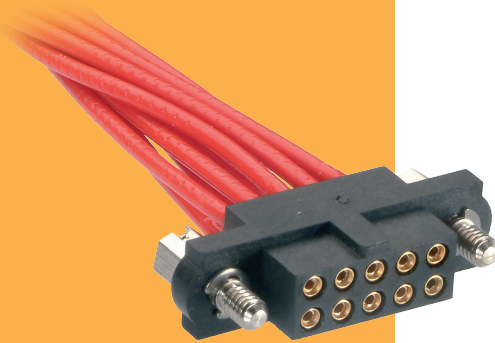

DATAMATE J-TEK

WITHOUT JACKSCREWS	WITH JACKSCREWS								
 <table border="1" style="margin-left: auto; margin-right: auto;"> <thead> <tr> <th colspan="2" style="background-color: #f4a460;">CALCULATION</th> </tr> </thead> <tbody> <tr> <td>A</td> <td>$B + 12$</td> </tr> <tr> <td>B</td> <td>Total no. of contacts - 2</td> </tr> <tr> <td>C</td> <td>$B + 7$</td> </tr> </tbody> </table>	CALCULATION		A	$B + 12$	B	Total no. of contacts - 2	C	$B + 7$	 <div style="display: flex; justify-content: space-around;"> <div style="text-align: center;"> <p>Hex Slotted Jackscrew</p> </div> <div style="text-align: center;"> <p>Hex Socket Jackscrew</p> </div> </div>
CALCULATION									
A	$B + 12$								
B	Total no. of contacts - 2								
C	$B + 7$								
TOOLS	WIRE STRIPPING DETAILS								
<p>Recommended Crimp Tool - M22520/2-01</p> <p>Positioner - T5747</p> <p>Contact Insertion/Removal Tool - Z80-280</p> <ul style="list-style-type: none"> Spare and pre-cabled contacts shown on following pages. Instruction sheets available at www.harwin.com/instructions. 									
HOW TO ORDER									
<p>M80 - 4 E1 XX XX FX</p>									
<p>SERIES CODE</p>	<p>JACKSCREW</p> <table border="1"> <tr> <td>00</td> <td>Without Jackscrews</td> </tr> <tr> <td>F1</td> <td>With Hex Slotted Jackscrews</td> </tr> <tr> <td>F2</td> <td>With Hex Socket Jackscrews</td> </tr> </table>	00	Without Jackscrews	F1	With Hex Slotted Jackscrews	F2	With Hex Socket Jackscrews		
00	Without Jackscrews								
F1	With Hex Slotted Jackscrews								
F2	With Hex Socket Jackscrews								
<p>TYPE</p> <table border="1"> <tr> <td>E1</td> <td>Extra Small Bore 28-32 AWG</td> </tr> </table>	E1	Extra Small Bore 28-32 AWG	<p>FINISH</p> <table border="1"> <tr> <td>05</td> <td>Gold</td> </tr> <tr> <td>42</td> <td>Gold + Tin</td> </tr> </table>	05	Gold	42	Gold + Tin		
E1	Extra Small Bore 28-32 AWG								
05	Gold								
42	Gold + Tin								
<p>TOTAL NO. OF CONTACTS</p> <p>04, 06, 08, 10, 12, 14, 20, 26, 34, 42, 50</p>									

All dimensions in mm.

Datamate J-Tek Connectors

Female Crimp Kit - Guide Pin, 101Lok

- Guide pin style includes board mount fixing.
- 101Lok fixing gives secure, fast and simple mating; no special tooling required. Just a simple 101-degree turn is required to fix the connectors together.
- Connectors mate with Datamate J-Tek male connectors with applicable jackscrews or 101Lok fixings.
- Part numbers are for a complete kit of a housing and the applicable number of contacts.

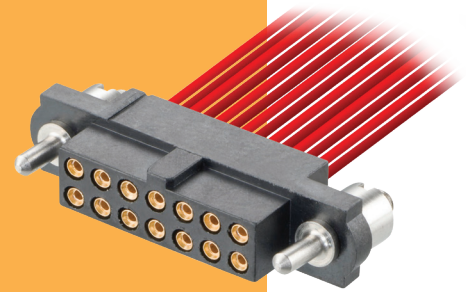

DATAMATE J-TEK

GUIDE PIN JACKSCREWS	101LOK														
<p>Board Mount Nut, 2 per connector</p> <table border="1"> <thead> <tr> <th colspan="2">CALCULATION</th> </tr> </thead> <tbody> <tr> <td>A</td> <td>B + 12</td> </tr> <tr> <td>B</td> <td>Total no. of contacts - 2</td> </tr> <tr> <td>C</td> <td>B + 7</td> </tr> </tbody> </table>	CALCULATION		A	B + 12	B	Total no. of contacts - 2	C	B + 7							
CALCULATION															
A	B + 12														
B	Total no. of contacts - 2														
C	B + 7														
<p>TOOLS</p> <p>Recommended Crimp Tool - M22520/2-01 Positioner - T5747 Contact Insertion/Removal Tool - Z80-280</p> <ul style="list-style-type: none"> Spare and pre-cabled contacts shown on following pages. Instruction sheets available at www.harwin.com/instructions. 	<p>WIRE STRIPPING DETAILS</p>														
<p>HOW TO ORDER</p>															
<p style="text-align: center;">M80 - 4 X1 XX XX FX</p> <table border="1"> <thead> <tr> <th>SERIES CODE</th> <th>JACKSCREW</th> </tr> </thead> <tbody> <tr> <td>C1 Small Bore (24-28 AWG)</td> <td>F3 Guide Pin</td> </tr> <tr> <td>D1 Large Bore (22 AWG)</td> <td>FC 101Lok</td> </tr> <tr> <td>E1 Extra Small Bore (28-32 AWG)</td> <td></td> </tr> </tbody> </table> <table border="1"> <thead> <tr> <th>FINISH</th> <th>TOTAL NO. OF CONTACTS</th> </tr> </thead> <tbody> <tr> <td>05 Gold</td> <td>04, 06, 08, 10, 12, 14, 20, 26, 34, 42, 50</td> </tr> <tr> <td>42 Gold + Tin</td> <td></td> </tr> </tbody> </table>		SERIES CODE	JACKSCREW	C1 Small Bore (24-28 AWG)	F3 Guide Pin	D1 Large Bore (22 AWG)	FC 101Lok	E1 Extra Small Bore (28-32 AWG)		FINISH	TOTAL NO. OF CONTACTS	05 Gold	04, 06, 08, 10, 12, 14, 20, 26, 34, 42, 50	42 Gold + Tin	
SERIES CODE	JACKSCREW														
C1 Small Bore (24-28 AWG)	F3 Guide Pin														
D1 Large Bore (22 AWG)	FC 101Lok														
E1 Extra Small Bore (28-32 AWG)															
FINISH	TOTAL NO. OF CONTACTS														
05 Gold	04, 06, 08, 10, 12, 14, 20, 26, 34, 42, 50														
42 Gold + Tin															

All dimensions in mm.

Datamate J-Tek Connectors

Female Crimp Kit - Reverse Fix

- ❖ Allows for further flexibility in system design.
- ❖ Crimp contacts supplied loose and are inserted from rear.
- ❖ Part numbers are for a complete kit of a housing and the applicable number of contacts.
- ❖ Jackscrews are assembled.
- ❖ Mates with male Datamate J-Tek connectors with compatible Reverse Fix jackscrews.

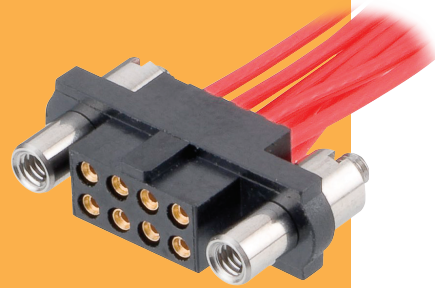

WITH JACKSCREWS	CALCULATION	WIRE STRIPPING DETAILS																																												
<p>No. 1 contact</p> <p>Board Mount Jackscrew</p> <p>Board Mount Nut, 2 per connector</p>	<table border="1"> <tr> <td>A</td> <td>$B + 12$</td> </tr> <tr> <td>B</td> <td>Total no. of contacts - 2</td> </tr> <tr> <td>C</td> <td>$B + 7$</td> </tr> </table>	A	$B + 12$	B	Total no. of contacts - 2	C	$B + 7$																																							
	A	$B + 12$																																												
	B	Total no. of contacts - 2																																												
C	$B + 7$																																													
		<table border="1"> <thead> <tr> <th colspan="2" style="background-color: #f4a460;">TOOLS</th> </tr> </thead> <tbody> <tr> <td colspan="2">Recommended Crimp Tool - M22520/2-01</td> </tr> <tr> <td colspan="2">Positioner - T5747</td> </tr> <tr> <td colspan="2">Contact Insertion/Removal Tool - Z80-280</td> </tr> <tr> <td colspan="2">❖ Spare and pre-cabled contacts shown on following pages.</td> </tr> <tr> <td colspan="2">❖ Instruction sheets available at www.harwin.com/instructions.</td> </tr> </tbody> </table>	TOOLS		Recommended Crimp Tool - M22520/2-01		Positioner - T5747		Contact Insertion/Removal Tool - Z80-280		❖ Spare and pre-cabled contacts shown on following pages.		❖ Instruction sheets available at www.harwin.com/instructions .																																	
TOOLS																																														
Recommended Crimp Tool - M22520/2-01																																														
Positioner - T5747																																														
Contact Insertion/Removal Tool - Z80-280																																														
❖ Spare and pre-cabled contacts shown on following pages.																																														
❖ Instruction sheets available at www.harwin.com/instructions .																																														
HOW TO ORDER																																														
<div style="display: flex; justify-content: space-around;"> <div style="text-align: center;"> <p>M80 - 4XX XX XX</p> <table border="1"> <thead> <tr> <th colspan="2" style="background-color: #f4a460;">SERIES CODE</th> </tr> </thead> <tbody> <tr> <td>TYPE</td> <td></td> </tr> <tr> <td>462</td> <td>Large Bore (22 AWG)</td> </tr> <tr> <td>463</td> <td>Small Bore (24-28 AWG)</td> </tr> </tbody> </table> <table border="1"> <thead> <tr> <th colspan="2" style="background-color: #f4a460;">TOTAL NO. OF CONTACTS</th> </tr> </thead> <tbody> <tr> <td colspan="2">04, 06, 08, 10, 12, 14, 20, 26, 34, 42, 50</td> </tr> </tbody> </table> <table border="1"> <thead> <tr> <th colspan="2" style="background-color: #f4a460;">FINISH</th> </tr> </thead> <tbody> <tr> <td>05</td> <td>Gold</td> </tr> <tr> <td>42</td> <td>Gold + Tin</td> </tr> </tbody> </table> <p>3.5mm Board Mount Jackscrews only</p> </div> <div style="text-align: center;"> <p>M80 - 4 X1 XX XX FX</p> <table border="1"> <thead> <tr> <th colspan="2" style="background-color: #f4a460;">SERIES CODE</th> </tr> </thead> <tbody> <tr> <td>TYPE</td> <td></td> </tr> <tr> <td>C1</td> <td>Small Bore (24-28 AWG)</td> </tr> <tr> <td>D1</td> <td>Large Bore (22 AWG)</td> </tr> <tr> <td>E1</td> <td>Extra Small Bore (28-32 AWG)</td> </tr> </tbody> </table> <table border="1"> <thead> <tr> <th colspan="2" style="background-color: #f4a460;">TOTAL NO. OF CONTACTS</th> </tr> </thead> <tbody> <tr> <td colspan="2">04, 06, 08, 10, 12, 14, 20, 26, 34, 42, 50</td> </tr> </tbody> </table> <table border="1"> <thead> <tr> <th colspan="2" style="background-color: #f4a460;">FINISH</th> </tr> </thead> <tbody> <tr> <td>05</td> <td>Gold</td> </tr> <tr> <td>42</td> <td>Gold + Tin</td> </tr> </tbody> </table> <table border="1"> <thead> <tr> <th colspan="2" style="background-color: #f4a460;">JACKSCREW</th> </tr> </thead> <tbody> <tr> <td>F8</td> <td>3.5mm Board Mount</td> </tr> <tr> <td>F9</td> <td>5mm Board Mount</td> </tr> </tbody> </table> </div> </div>			SERIES CODE		TYPE		462	Large Bore (22 AWG)	463	Small Bore (24-28 AWG)	TOTAL NO. OF CONTACTS		04, 06, 08, 10, 12, 14, 20, 26, 34, 42, 50		FINISH		05	Gold	42	Gold + Tin	SERIES CODE		TYPE		C1	Small Bore (24-28 AWG)	D1	Large Bore (22 AWG)	E1	Extra Small Bore (28-32 AWG)	TOTAL NO. OF CONTACTS		04, 06, 08, 10, 12, 14, 20, 26, 34, 42, 50		FINISH		05	Gold	42	Gold + Tin	JACKSCREW		F8	3.5mm Board Mount	F9	5mm Board Mount
SERIES CODE																																														
TYPE																																														
462	Large Bore (22 AWG)																																													
463	Small Bore (24-28 AWG)																																													
TOTAL NO. OF CONTACTS																																														
04, 06, 08, 10, 12, 14, 20, 26, 34, 42, 50																																														
FINISH																																														
05	Gold																																													
42	Gold + Tin																																													
SERIES CODE																																														
TYPE																																														
C1	Small Bore (24-28 AWG)																																													
D1	Large Bore (22 AWG)																																													
E1	Extra Small Bore (28-32 AWG)																																													
TOTAL NO. OF CONTACTS																																														
04, 06, 08, 10, 12, 14, 20, 26, 34, 42, 50																																														
FINISH																																														
05	Gold																																													
42	Gold + Tin																																													
JACKSCREW																																														
F8	3.5mm Board Mount																																													
F9	5mm Board Mount																																													

All dimensions in mm.

Datamate J-Tek Connectors

Female Crimp Kit - Extended Wall

- ❖ Extended Wall Datamate allows back potting to be performed.
- ❖ Polarized housings.
- ❖ Crimp contacts are rear insertable.
- ❖ Large bore 22 AWG, small bore 24 - 28 AWG.
- ❖ Part numbers are for a housing and the equivalent number of contacts.

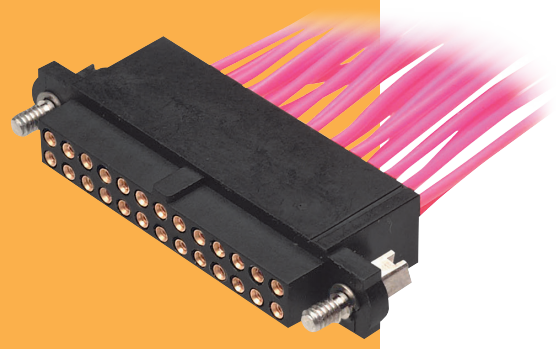

DATAMATE J-TEK

WITHOUT JACKSCREWS	WITH JACKSCREWS																
<table border="1" style="margin-top: 10px;"> <thead> <tr> <th colspan="2" style="background-color: #f4a460;">CALCULATION</th> </tr> </thead> <tbody> <tr> <td style="background-color: #f4a460;">A</td> <td>B + 12</td> </tr> <tr> <td style="background-color: #f4a460;">B</td> <td>Total no. of contacts - 2</td> </tr> <tr> <td style="background-color: #f4a460;">C</td> <td>B + 7</td> </tr> </tbody> </table>	CALCULATION		A	B + 12	B	Total no. of contacts - 2	C	B + 7									
CALCULATION																	
A	B + 12																
B	Total no. of contacts - 2																
C	B + 7																
TOOLS	WIRE STRIPPING DETAILS																
<p>Recommended Crimp Tool - M22520/2-01</p> <p>Positioner - T5747</p> <p>Contact Insertion/Removal Tool - Z80-280</p> <ul style="list-style-type: none"> ❖ Spare and pre-cabled contacts shown on following pages. ❖ Instruction sheets available at www.harwin.com/instructions. 																	
HOW TO ORDER																	
M80 - XXX XX XX																	
SERIES CODE	WALL SIZE																
<table border="1" style="width: 100%;"> <thead> <tr> <th style="background-color: #f4a460;">LARGE BORE (22 AWG)</th> <th style="background-color: #f4a460;">SMALL BORE (24-28 AWG)</th> <th></th> </tr> </thead> <tbody> <tr> <td style="text-align: center;">475</td> <td style="text-align: center;">476</td> <td>Without Jackscrews</td> </tr> <tr> <td style="text-align: center;">465</td> <td style="text-align: center;">466</td> <td>With Hex Slotted Jackscrews</td> </tr> <tr> <td style="text-align: center;">485</td> <td style="text-align: center;">486</td> <td>With Hex Socket Jackscrews</td> </tr> </tbody> </table>	LARGE BORE (22 AWG)	SMALL BORE (24-28 AWG)		475	476	Without Jackscrews	465	466	With Hex Slotted Jackscrews	485	486	With Hex Socket Jackscrews	<table border="1" style="width: 100%;"> <tbody> <tr> <td style="background-color: #f4a460;">BLANK</td> <td>Wall = 5mm</td> </tr> <tr> <td style="background-color: #f4a460;">A</td> <td>Wall = 1mm</td> </tr> </tbody> </table>	BLANK	Wall = 5mm	A	Wall = 1mm
LARGE BORE (22 AWG)	SMALL BORE (24-28 AWG)																
475	476	Without Jackscrews															
465	466	With Hex Slotted Jackscrews															
485	486	With Hex Socket Jackscrews															
BLANK	Wall = 5mm																
A	Wall = 1mm																
	FINISH																
	<table border="1" style="width: 100%;"> <tbody> <tr> <td style="background-color: #f4a460;">05</td> <td>Gold</td> </tr> <tr> <td style="background-color: #f4a460;">42</td> <td>Gold + Tin</td> </tr> </tbody> </table>	05	Gold	42	Gold + Tin												
05	Gold																
42	Gold + Tin																
	TOTAL NO. OF CONTACTS																
	06, 10, 12, 14, 18, 20, 26, 34, 42, 50																

All dimensions in mm.

Datamate J-Tek Connectors

Female Crimp Kit with Hood

- Supplied as a complete kit: jackscrews assembled to housing; hood, contacts and assembly screws supplied loose.
- Provides strain relief by preventing cable bending at the rear of the connector, and also has the option of inserting a cable tie to reduce pull strain.

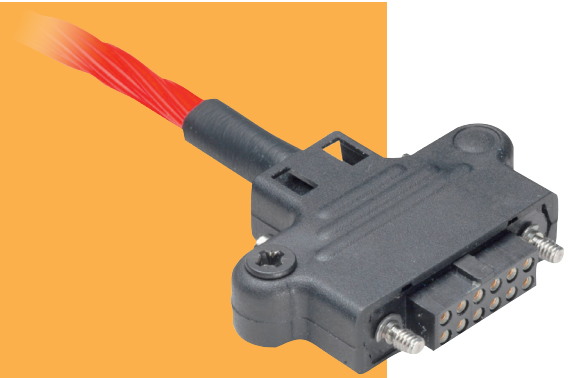

DATAMATE J-TEK

FEMALE		CALCULATION									
		A	$B + 21.5$								
		B	Total no. of contacts - 2								
		C	$B + 7$								
TOOLS		WIRE STRIPPING DETAILS									
<p>Recommended Crimp Tool - M22520/2-01 Positioner - T5747 Contact Insertion/Removal Tool - Z80-280</p> <ul style="list-style-type: none"> ➤ Spare and pre-cabled contacts shown on following pages. ➤ Instruction sheets available at www.harwin.com/instructions. 											
HOW TO ORDER											
<p>SERIES CODE</p> <p>TYPE</p> <table border="1"> <tr> <td>0</td> <td>Small Bore (24-28 AWG)</td> </tr> <tr> <td>1</td> <td>Large Bore (22 AWG)</td> </tr> </table>		0	Small Bore (24-28 AWG)	1	Large Bore (22 AWG)	<p>FINISH</p> <table border="1"> <tr> <td>05</td> <td>Gold</td> </tr> <tr> <td>42</td> <td>Gold + Tin</td> </tr> </table>		05	Gold	42	Gold + Tin
0	Small Bore (24-28 AWG)										
1	Large Bore (22 AWG)										
05	Gold										
42	Gold + Tin										
<p>M80 - 94 X XX XX</p>		<p>TOTAL NO. OF CONTACTS</p> <p>06, 08, 10, 12, 14, 20, 26, 34, 42, 50</p>									

All dimensions in mm.

Datamate J-Tek Connectors

Spare Female Crimp Contacts

❖ Barrel Crimp Contacts are supplied with the connectors - see previous page. Use the order code for extra spare crimps.



DATAMATE J-TEK

CRIMP CONTACTS	DUMMY CONTACT
<p>Large Bore (22 AWG)</p> <p>Small Bore (24 to 28 AWG)</p> <p>Extra Small Bore (28 to 32 AWG)</p>	<div style="border: 1px solid black; padding: 2px; width: fit-content; margin-top: 5px;"> ORDER CODE M80-023 </div>
	WIRE STRIPPING DETAILS
	TOOLS
	<p>Recommended Crimp Tool - M22520/2-01 Positioner - T5747 Contact Insertion/Removal Tool - Z80-280</p> <ul style="list-style-type: none"> ❖ Pre-cabled contacts shown on following page. ❖ Instruction sheets available at www.harwin.com/instructions.

HOW TO ORDER

M80 - OXX 00 XX

SERIES CODE

TYPE	
011	Large Bore (22 AWG)
013	Small Bore (24-28 AWG)
019	Extra Small Bore (28-32 AWG)

FINISH

01	Gold + Tin
05	Gold

All dimensions in mm.

Datamate J-Tek Connectors

Female Crimp Contacts – Pre-Crimped Wires

- Female crimp contacts pre-assembled with a choice of BS 3G 210 Type A cable at selected lengths.
- PTFE-insulated, multi-strand silver-plated copper conductor equipment wire.
- Ideal for prototype and pre-production applications.

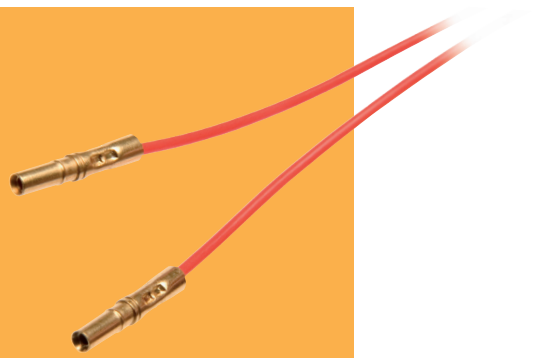

FEMALE SINGLE ENDED	FEMALE - FEMALE

TOOLS

Contact Insertion/Removal Tool – Z80-280

- Full crimp connector kits and spare crimp contacts shown on previous pages.
- Full cable assemblies shown on following page.
- Instruction sheets available at www.harwin.com/instructions.

HOW TO ORDER

M80 - 9XX 00 99

SERIES CODE

CABLE COLOR

99	Red
-----------	-----

SINGLE ENDED	FEMALE-FEMALE	
910	918	22 AWG Cable, 150mm length
911	919	24 AWG Cable, 150mm length
912	920	26 AWG Cable, 150mm length
913	921	28 AWG Cable, 150mm length
914	922	22 AWG Cable, 300mm length
915	923	24 AWG Cable, 300mm length
916	924	26 AWG Cable, 300mm length
917	925	28 AWG Cable, 300mm length

All dimensions in mm.

Datamate J-Tek Connectors

Female Cable Assemblies

- Ready-made cable assemblies, fully tested and inspected.
- Extended wall connectors are backpotted for additional strain relief.
- Stainless steel jackscrews to mate with applicable male connector.
- Constructed with Contact 1 to Contact 1, Contact 2 to Contact 2, etc.
- For multicolor sequence, check applicable Technical Drawing.



DATAMATE J-TEK

PART NUMBERING SYSTEM

M80 - F X X XX XX FX - XXXX XX

SERIES CODE

GENDER - FIRST END

F	Female
----------	--------

CONNECTOR STYLE

C	Standard (no extended wall)
E	5mm Extended Wall
F	1mm Extended Wall

CABLE SIZE

1	22 AWG
2	24 AWG
3	26 AWG
4	28 AWG
5	30 AWG

TOTAL NO. OF CONTACTS

04 to 50 (even numbers only)

CABLE COLOR

05	White cable (double-ended)
68	Multicolor cable (single-ended)

TERMINATION - SECOND END

L	Loose cut end
F0, F1, F2 or FC	Female connector (Same as First End)

CABLE LENGTH

0150	150mm
0300	300mm (double-ended)
0450	450mm (single-ended)
XXXX	XXXXmm

JACKSCREW

F0	No fixings
F1	Floating Hex Slotted
F2	Floating Hex Socket
FC	101Lok

All dimensions in mm.

Datamate J-Tek Connectors

- ❖ Examples of available cable assembly options - see previous page for part numbering.
- ❖ Cable assemblies are constructed with Contact 1 to Contact 1, Contact 2 to Contact 2, etc.

FEMALE SINGLE ENDED

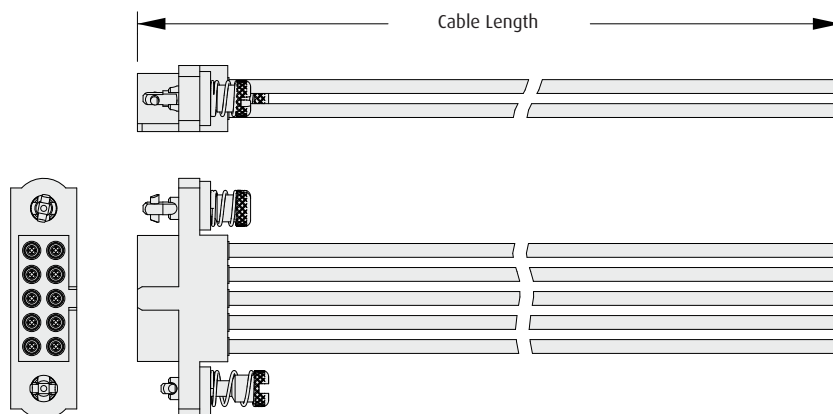

FEMALE - FEMALE

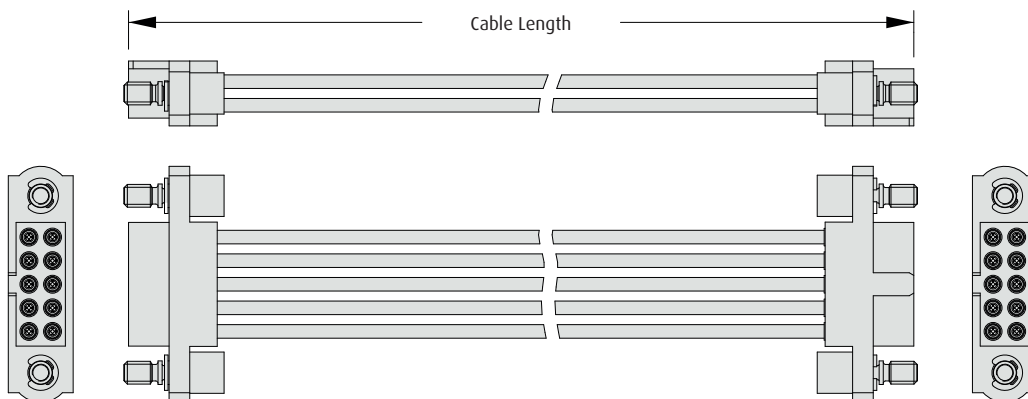

FEMALE - FEMALE WITH EXTENDED WALLS

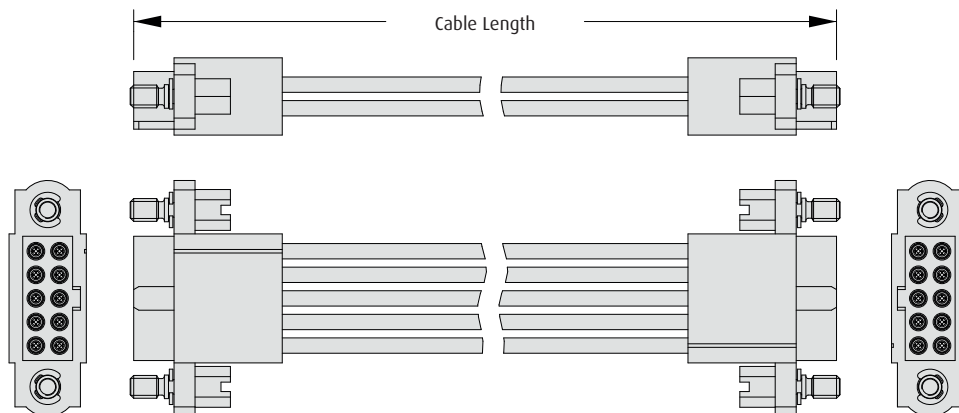

All dimensions in mm.

Datamate J-Tek Connectors

Female Crimp T-Contact

- ❖ Advanced single-piece contact design using Beryllium Copper for a 6-finger contact with improved capabilities.
- ❖ Current carrying capacity up to 8.5 Amps per contact.
- ❖ Improved mating durability to 1,000 operations.
- ❖ Suitable for use with 22AWG cable, Ø1.1mm maximum insulation diameter.
- ❖ Compatible cable housings showing on the following pages - order contact and housings separately.



DATAMATE J-TEK

CRIMP CONTACTS

Large Bore (22 AWG)

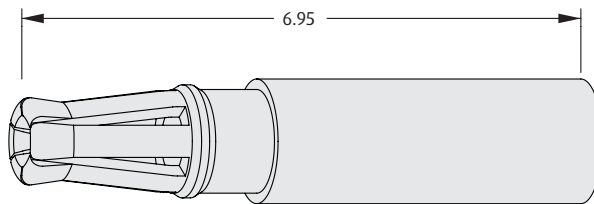

TOOLS

Recommended Crimp Tool - M22520/2-01
Positioner - Z80-444
Contact insertion/Removal Tool - Z80-280
 ❖ Instruction sheets available at www.harwin.com/instructions.

WIRE STRIPPING DETAILS

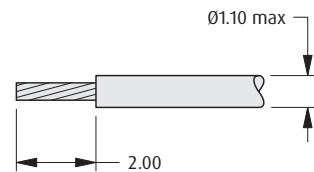

HOW TO ORDER

M80 - 206 00 05

SERIES CODE

FINISH

05 Gold

All dimensions in mm.

Patent Pending

Datamate J-Tek Connectors

Female Crimp Housing

- ❖ Compatible with all female signal barrel crimp contacts, including T-Contact shown on previous page.
- ❖ Use insertion tool to insert crimped contacts into rear of connector housing: **order code Z80-280**.
- ❖ Connectors mate with Datamate J-Tek male connectors with applicable jackscrews.
- ❖ Jackscrews are supplied already assembled to housing.

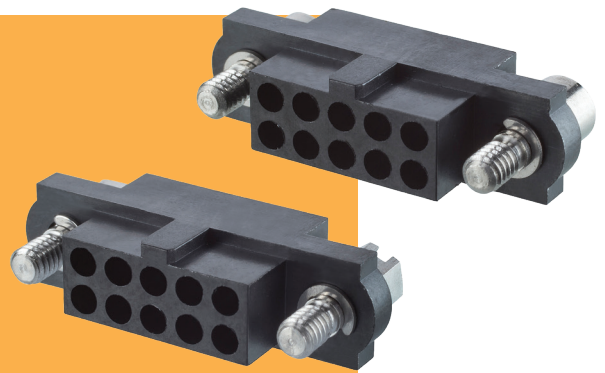

DATAMATE J-TEK

HEX SLOTTED JACKSCREWS

HEX SOCKET JACKSCREWS

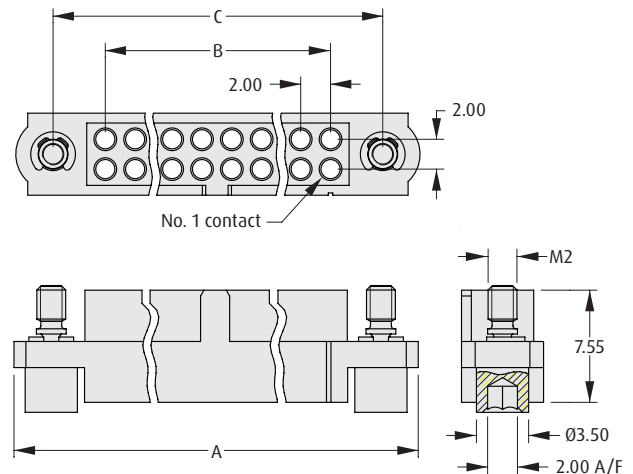
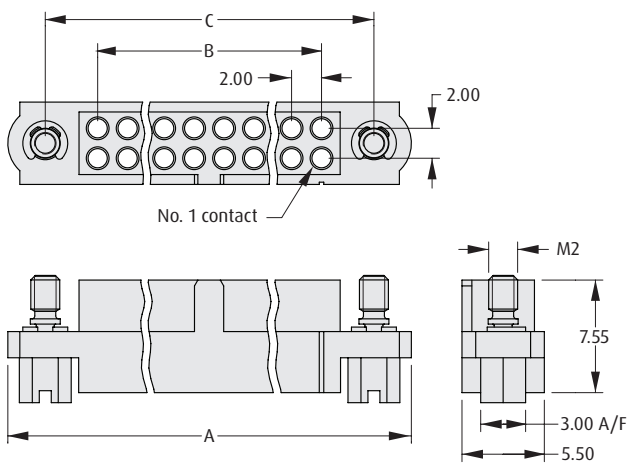

CALCULATION

A	$B + 12$
B	Total no. of contacts - 2
C	$B + 7$

HOW TO ORDER

M80 - 41 X XX 98

SERIES CODE

JACKSCREW TYPE

3	Hex Slotted Jackscrews
4	Hex Socket Jackscrews

TOTAL NO. OF CONTACTS

04 to 50 (Even numbers only)

All dimensions in mm.

Datamate J-Tek Connectors

Female Crimp Housing - Guide Pin, 101Lok

- Compatible with all female signal barrel crimp contacts, including T-Contact shown on previous page.
- Guide pin style includes board mount fixing.
- 101Lok fixing gives secure, fast and simple mating; no special tooling required. Just a simple 101-degree turn is required to fix the connectors together.
- Connectors mate with Datamate J-Tek male connectors with applicable jackscrews or 101Lok fixings.

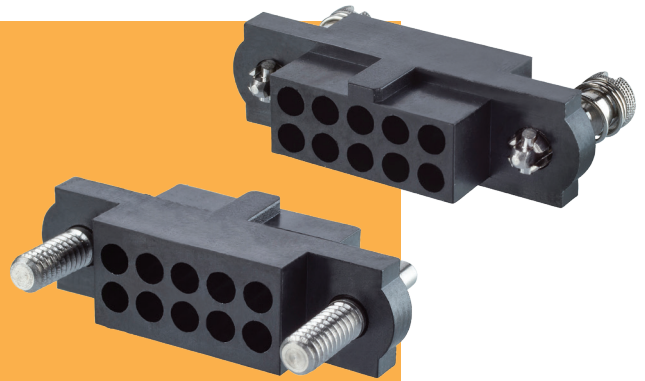

DATAMATE J-TEK

GUIDE PIN JACKSCREWS	101LOK								
<table border="1" style="background-color: #f4a460;"> <thead> <tr> <th colspan="2">CALCULATION</th> </tr> </thead> <tbody> <tr> <td>A</td> <td>B + 12</td> </tr> <tr> <td>B</td> <td>Total no. of contacts - 2</td> </tr> <tr> <td>C</td> <td>B + 7</td> </tr> </tbody> </table>		CALCULATION		A	B + 12	B	Total no. of contacts - 2	C	B + 7
CALCULATION									
A	B + 12								
B	Total no. of contacts - 2								
C	B + 7								
HOW TO ORDER M80 - 41 X XX 98									
SERIES CODE	TOTAL NO. OF CONTACTS 04 to 50 (Even numbers only)								
<table border="1"> <thead> <tr> <th colspan="2">JACKSCREW TYPE</th> </tr> </thead> <tbody> <tr> <td style="text-align: center;">7</td> <td>Guide Pin Jackscrews</td> </tr> <tr> <td style="text-align: center;">8</td> <td>101Lok</td> </tr> </tbody> </table>	JACKSCREW TYPE		7	Guide Pin Jackscrews	8	101Lok			
JACKSCREW TYPE									
7	Guide Pin Jackscrews								
8	101Lok								
HARDWARE FOR GUIDE PIN STUD	Order separately from connector								
Slotted Board Mount Nut <table border="1" style="background-color: #f4a460; margin-top: 10px;"> <thead> <tr> <th>ORDER CODE</th> </tr> </thead> <tbody> <tr> <td>M80-2130000B</td> </tr> </tbody> </table>	ORDER CODE	M80-2130000B	Hexagonal Board Mount Nut <table border="1" style="background-color: #f4a460; margin-top: 10px;"> <thead> <tr> <th>ORDER CODE</th> </tr> </thead> <tbody> <tr> <td>M80-2430000B</td> </tr> </tbody> </table>	ORDER CODE	M80-2430000B				
ORDER CODE									
M80-2130000B									
ORDER CODE									
M80-2430000B									

All dimensions in mm.

Datamate J-Tek Connectors

Female Crimp Housing - Reverse Fix

- Compatible with all female signal barrel crimp contacts, including T-Contact shown on previous page.
- Use insertion tool to insert crimped contacts into rear of connector housing: **order code Z80-280**.
- Jackscrows are supplied already assembled to housing.
- Connectors mate with Datamate J-Tek male connectors with compatible Reverse Fix jackscrows.

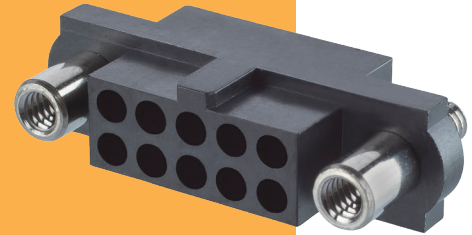

DATAMATE J-TEK

REVERSE FIX JACKSCREWS

CALCULATION

A	B + 12
B	Total no. of contacts - 2
C	B + 7

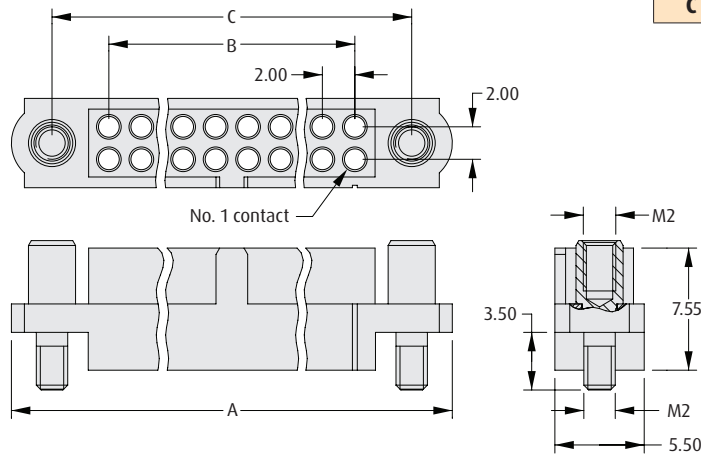

HOW TO ORDER

M80 - 41 5 XX 98

SERIES CODE

JACKSCREW TYPE

5 Reverse Fix Jackscrew

TOTAL NO. OF CONTACTS

04 to 50 (Even numbers only)

HARDWARE FOR PANEL MOUNT STUD

Order separately from connector

Slotted Board Mount Nut

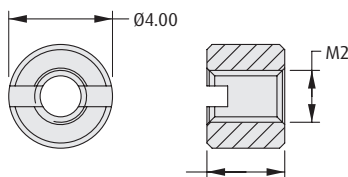

ORDER CODE

M80-2130000B

Hexagonal Board Mount Nut

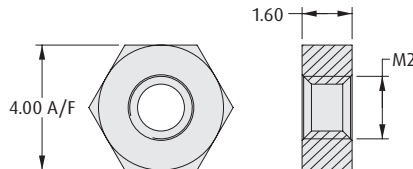

ORDER CODE

M80-2430000B

All dimensions in mm.

Datamate J-Tek Connectors

Female Cable Assemblies - T-Contact

- Ready-made cable assemblies, fully tested and inspected.
- 6-finger Beryllium Copper T-Contacts, up to 8.5A per contact.
- Stainless steel jackscrews to mate with applicable male connector.
- Constructed with Contact 1 to Contact 1, Contact A to Contact A, etc.
- For multicolor sequence, check applicable Technical Drawing.



DATAMATE J-TEK

FEMALE SINGLE ENDED	FEMALE - FEMALE																																								
HOW TO ORDER																																									
M80 - F B1 XX XX FX - XXXX XX																																									
<table border="1" style="width: 100%; border-collapse: collapse;"> <tr style="background-color: #f4a460; color: white;"> <th colspan="2">SERIES CODE</th> </tr> <tr> <td style="width: 20px; text-align: center;">M80</td> <td></td> </tr> </table> <table border="1" style="width: 100%; border-collapse: collapse;"> <tr style="background-color: #f4a460; color: white;"> <th colspan="2">GENDER - FIRST END</th> </tr> <tr> <td style="width: 20px; text-align: center;">F</td> <td>Female</td> </tr> </table> <table border="1" style="width: 100%; border-collapse: collapse;"> <tr style="background-color: #f4a460; color: white;"> <th colspan="2">CABLE SIZE</th> </tr> <tr> <td style="width: 20px; text-align: center;">B1</td> <td>22 AWG, T-Contact</td> </tr> </table> <table border="1" style="width: 100%; border-collapse: collapse;"> <tr style="background-color: #f4a460; color: white;"> <th colspan="2">TOTAL NO. OF CONTACTS</th> </tr> <tr> <td style="width: 20px; text-align: center;">04 to 50</td> <td>(even numbers only)</td> </tr> </table> <table border="1" style="width: 100%; border-collapse: collapse;"> <tr style="background-color: #f4a460; color: white;"> <th colspan="2">CABLE COLOR</th> </tr> <tr> <td style="width: 20px; text-align: center;">05</td> <td>White cable (double-ended)</td> </tr> <tr> <td style="width: 20px; text-align: center;">68</td> <td>Multicolor cable (single-ended)</td> </tr> </table>	SERIES CODE		M80		GENDER - FIRST END		F	Female	CABLE SIZE		B1	22 AWG, T-Contact	TOTAL NO. OF CONTACTS		04 to 50	(even numbers only)	CABLE COLOR		05	White cable (double-ended)	68	Multicolor cable (single-ended)	<table border="1" style="width: 100%; border-collapse: collapse;"> <tr style="background-color: #f4a460; color: white;"> <th colspan="2">TERMINATION - SECOND END</th> </tr> <tr> <td style="width: 20px; text-align: center;">L</td> <td>Loose cut end</td> </tr> <tr> <td style="width: 20px; text-align: center;">F1, F2 or FC</td> <td>Female connector (same as First End)</td> </tr> </table> <table border="1" style="width: 100%; border-collapse: collapse;"> <tr style="background-color: #f4a460; color: white;"> <th colspan="2">CABLE LENGTH</th> </tr> <tr> <td style="width: 20px; text-align: center;">XXXX</td> <td>XXXXmm</td> </tr> </table> <table border="1" style="width: 100%; border-collapse: collapse;"> <tr style="background-color: #f4a460; color: white;"> <th colspan="2">SCREW-LOK</th> </tr> <tr> <td style="width: 20px; text-align: center;">F1</td> <td>Floating Hex Slotted</td> </tr> <tr> <td style="width: 20px; text-align: center;">F2</td> <td>Floating Hex Socket</td> </tr> <tr> <td style="width: 20px; text-align: center;">FC</td> <td>101Lok</td> </tr> </table>	TERMINATION - SECOND END		L	Loose cut end	F1, F2 or FC	Female connector (same as First End)	CABLE LENGTH		XXXX	XXXXmm	SCREW-LOK		F1	Floating Hex Slotted	F2	Floating Hex Socket	FC	101Lok
SERIES CODE																																									
M80																																									
GENDER - FIRST END																																									
F	Female																																								
CABLE SIZE																																									
B1	22 AWG, T-Contact																																								
TOTAL NO. OF CONTACTS																																									
04 to 50	(even numbers only)																																								
CABLE COLOR																																									
05	White cable (double-ended)																																								
68	Multicolor cable (single-ended)																																								
TERMINATION - SECOND END																																									
L	Loose cut end																																								
F1, F2 or FC	Female connector (same as First End)																																								
CABLE LENGTH																																									
XXXX	XXXXmm																																								
SCREW-LOK																																									
F1	Floating Hex Slotted																																								
F2	Floating Hex Socket																																								
FC	101Lok																																								

All dimensions in mm.

Datamate J-Tek Connectors

Female Metal Backshell

- ❖ Supplied as an accessory kit, including metal backshell, e-clips and the applicable jackscrews.
- ❖ To be used with the appropriate size of Female Crimp Kit without jackscrews.
- ❖ Gives 360 degree shielding when used with conductive braid and mated to a compatible male connector with metal backshell.
- ❖ Instruction sheets available at www.harwin.com/instructions.



DATAMATE J-TEK

FEMALE		CALCULATION											
		A	$B + 16.2$										
		B	Equivalent no. of contacts - 2										
		C	$B + 7$										
		D	$B + 0.8$										
E-CLIP TOOL		BAND-IT TIE											
❖ For assembling E-Clips supplied with kit.		❖ For fixing braid to rear collar (requires Tie Dex II A30199 Micro Band tool).											
<table border="1"> <thead> <tr> <th colspan="2">ORDER CODE</th> </tr> </thead> <tbody> <tr> <td>Z80-300</td> <td></td> </tr> </tbody> </table>		ORDER CODE		Z80-300		<table border="1"> <thead> <tr> <th colspan="2">ORDER CODE</th> </tr> </thead> <tbody> <tr> <td>M80-9470000</td> <td>Length = 206.8mm</td> </tr> <tr> <td>M80-9480000</td> <td>Length = 362.0mm</td> </tr> </tbody> </table>		ORDER CODE		M80-9470000	Length = 206.8mm	M80-9480000	Length = 362.0mm
ORDER CODE													
Z80-300													
ORDER CODE													
M80-9470000	Length = 206.8mm												
M80-9480000	Length = 362.0mm												
HOW TO ORDER													
M80 - 94 X XX 02													
<table border="1"> <thead> <tr> <th colspan="2">SERIES CODE</th> </tr> </thead> <tbody> <tr> <td>M80</td> <td>94</td> </tr> </tbody> </table>		SERIES CODE		M80	94	<table border="1"> <thead> <tr> <th colspan="2">FINISH</th> </tr> </thead> <tbody> <tr> <td>02</td> <td>Nickel</td> </tr> </tbody> </table>		FINISH		02	Nickel		
SERIES CODE													
M80	94												
FINISH													
02	Nickel												
<table border="1"> <thead> <tr> <th colspan="2">TYPE</th> </tr> </thead> <tbody> <tr> <td>5</td> <td>With Slotted Jackscrews</td> </tr> <tr> <td>6</td> <td>With Hex Socket Jackscrews</td> </tr> </tbody> </table>		TYPE		5	With Slotted Jackscrews	6	With Hex Socket Jackscrews	<table border="1"> <thead> <tr> <th colspan="2">EQUIVALENT NO. OF SIGNAL CONTACTS</th> </tr> </thead> <tbody> <tr> <td colspan="2">08 to 28, 32 to 50 (Even numbers only)</td> </tr> </tbody> </table>		EQUIVALENT NO. OF SIGNAL CONTACTS		08 to 28, 32 to 50 (Even numbers only)	
TYPE													
5	With Slotted Jackscrews												
6	With Hex Socket Jackscrews												
EQUIVALENT NO. OF SIGNAL CONTACTS													
08 to 28, 32 to 50 (Even numbers only)													

All dimensions in mm.

Datamate J-Tek Connectors

DATAMATE J-TEK

Male Vertical Throughboard

- Polarized housings.
- Fully shrouded contacts.
- Jackscrews are assembled where specified.
- Choice of throughboard termination length.
- Board Mount provides PCB strain relief.
- Mates with female Datamate J-Tek connectors with compatible jackscrews.

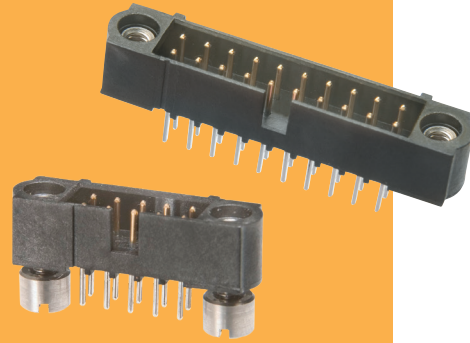

WITHOUT JACKSCREWS		WITH JACKSCREWS		WITH BOARD MOUNT											
				<p>Board Mount Nut, 2 per connector</p>											
				<p>Recommended PC Board Pattern</p>											
				<p>CALCULATION</p> <table border="1"> <tr> <td>A</td> <td>B + 12</td> </tr> <tr> <td>B</td> <td>Total no. of contacts - 2</td> </tr> <tr> <td>C</td> <td>B + 7</td> </tr> </table>		A	B + 12	B	Total no. of contacts - 2	C	B + 7				
A	B + 12														
B	Total no. of contacts - 2														
C	B + 7														
HOW TO ORDER															
M80 - 5 X X XX XX															
<p>SERIES CODE</p> <table border="1"> <tr> <td>0</td> <td>With Jackscrews</td> </tr> <tr> <td>1</td> <td>With Board Mount</td> </tr> <tr> <td>2</td> <td>Without Jackscrews</td> </tr> </table>		0	With Jackscrews	1	With Board Mount	2	Without Jackscrews			<p>FINISH</p> <table border="1"> <tr> <td>05</td> <td>Gold</td> </tr> <tr> <td>42</td> <td>Gold + Tin</td> </tr> </table>		05	Gold	42	Gold + Tin
0	With Jackscrews														
1	With Board Mount														
2	Without Jackscrews														
05	Gold														
42	Gold + Tin														
<table border="1"> <tr> <td>0</td> <td>3mm Tails</td> </tr> <tr> <td>1</td> <td>4.5mm Tails</td> </tr> </table>		0	3mm Tails	1	4.5mm Tails			<p>TOTAL NO. OF CONTACTS</p> <p>04, 06, 08, 10, 12, 14, 20, 26, 34, 42, 50</p>							
0	3mm Tails														
1	4.5mm Tails														

All dimensions in mm.

Datamate J-Tek Connectors

Male Vertical Throughboard 101Lok

- ❖ 101Lok fixing gives secure, fast and simple mating; no special tooling required. Just a simple 101-degree turn is required to fix the connectors together.
- ❖ Connectors mate with Datamate J-Tek female connectors with applicable 101Lok fixings.
- ❖ Board Mount provides PCB strain relief.
- ❖ Choice of throughboard termination length.

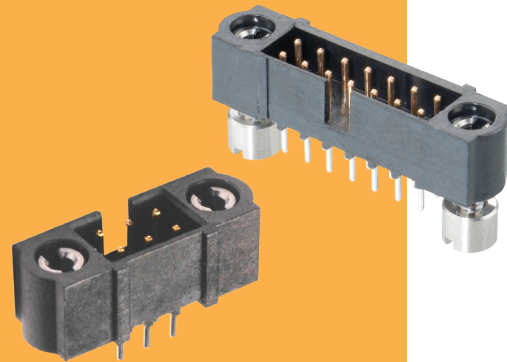

101LOK

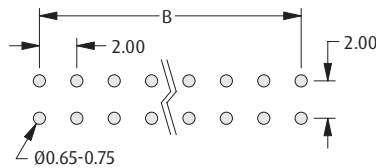
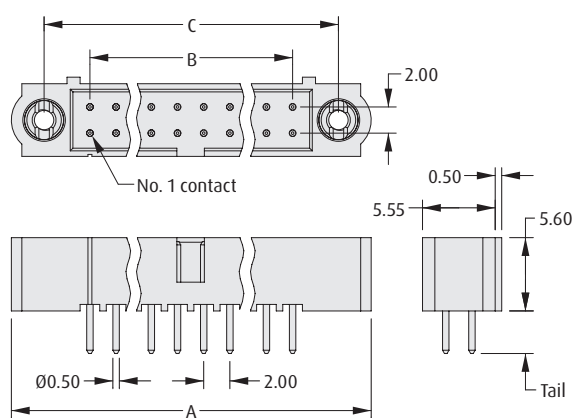

Recommended PC Board Pattern

CALCULATION	
A	$B + 12$
B	Total no. of contacts - 2
C	$B + 7$

101LOK WITH BOARD MOUNT

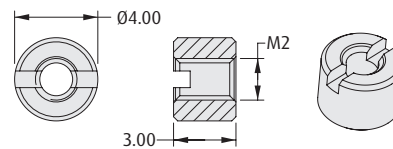
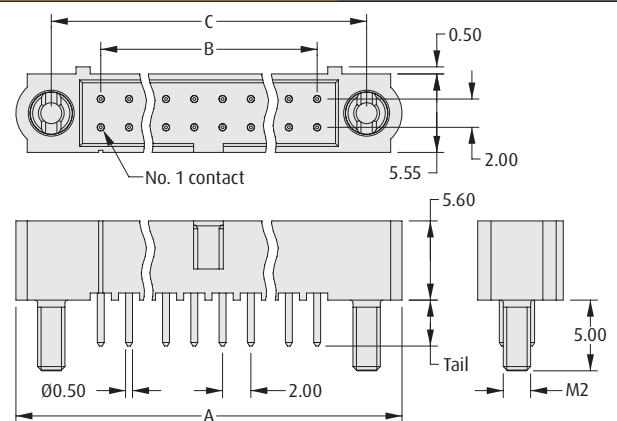

Board Mount Nut, 2 per connector

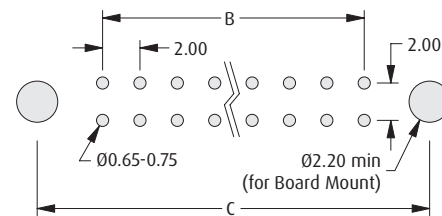

Recommended PC Board Pattern

HOW TO ORDER

M80 - 5 TX XX XX MX

SERIES CODE

TYPE

T1	3mm Tails
T2	4.5mm Tails

TOTAL NO. OF CONTACTS

04, 06, 08, 10, 12, 14, 20, 26, 34, 42, 50

JACKSCREW

MC	101Lok
ME	101Lok with Board Mount

FINISH

05	Gold
42	Gold + Tin

All dimensions in mm.

Datamate J-Tek Connectors

DATAMATE J-TEK

Male Horizontal Throughboard

- Polarized housings.
- Fully shrouded contacts.
- Jackscrews are assembled where specified.
- Choice of throughboard termination length.
- Board Mount provides PCB strain relief.
- Mates with female Datamate J-Tek connectors with compatible jackscrews.

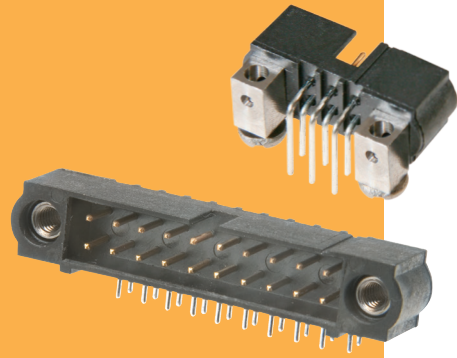

WITHOUT JACKSCREWS

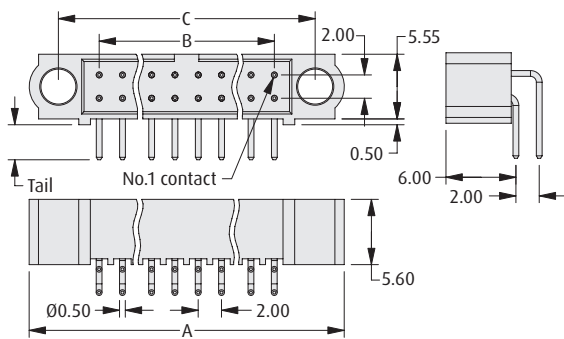

CALCULATION

A	$B + 12$
B	Total no. of contacts - 2
C	$B + 7$

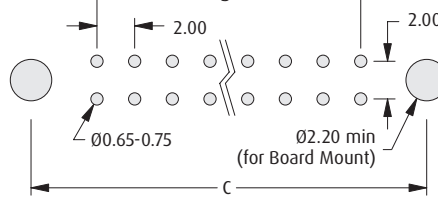

Recommended PC Board Pattern

WITH JACKSCREWS

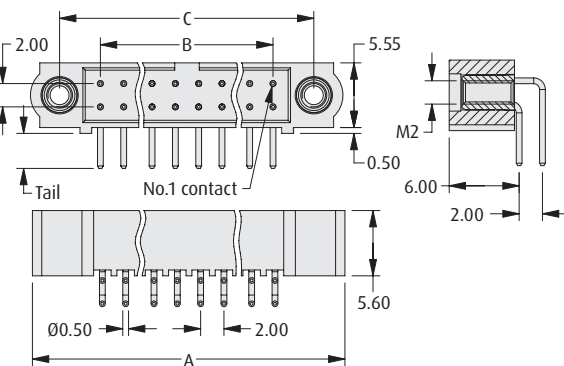

WITH BOARD MOUNT

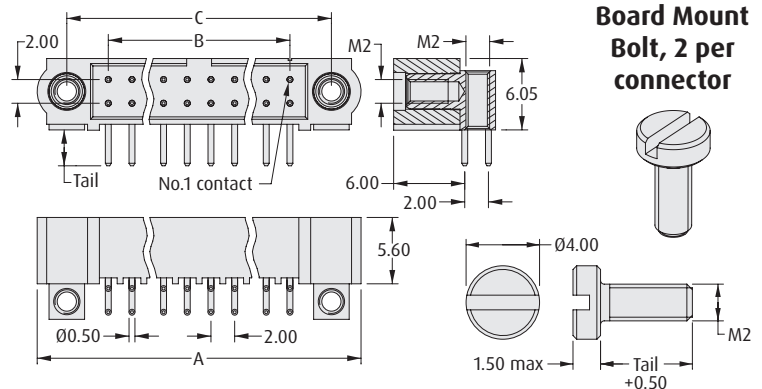

HOW TO ORDER

M80 - 5 X X XX XX

SERIES CODE

3	With Jackscrews
4	With Board Mount
5	Without Jackscrews

0	3mm Tails
1	4.5mm Tails

FINISH

05	Gold
42	Gold + Tin

TOTAL NO. OF CONTACTS

04, 06, 08, 10, 12, 14, 20, 26, 34, 42, 50

All dimensions in mm.

Datamate J-Tek Connectors

Male Horizontal Throughboard 101Lok

- ❖ 101Lok fixing gives secure, fast and simple mating; no special tooling required. Just a simple 101-degree turn is required to fix the connectors together.
- ❖ Connectors mate with Datamate J-Tek female connectors with applicable 101Lok fixings.
- ❖ Board Mount provides PCB strain relief.
- ❖ Choice of throughboard termination length.

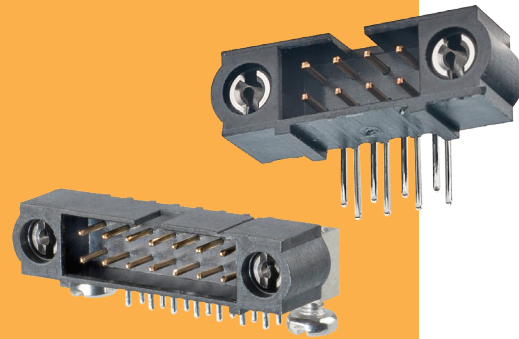

101LOK

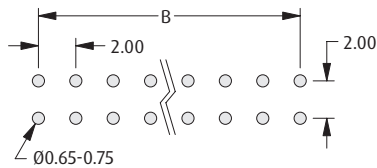
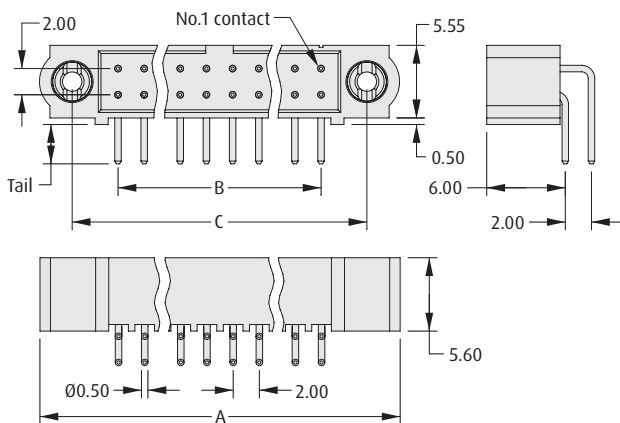

Recommended PC Board Pattern

CALCULATION	
A	$B + 12$
B	Total no. of contacts - 2
C	$B + 7$

101LOK WITH BOARD MOUNT

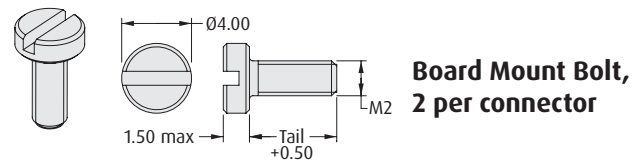
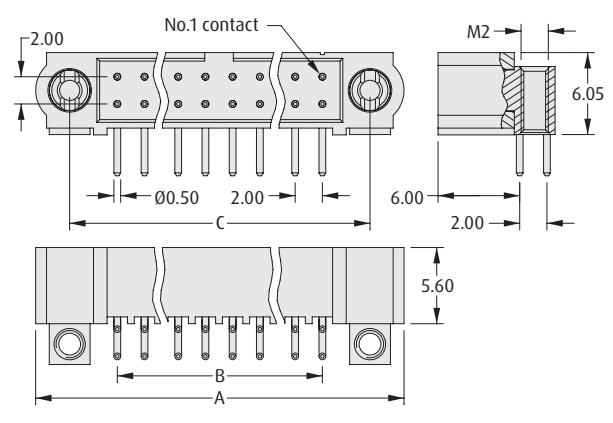

Board Mount Bolt, 2 per connector

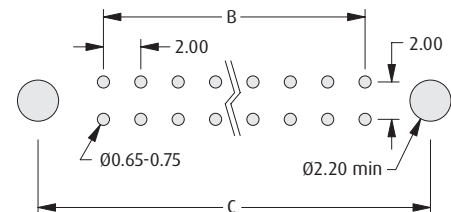

Recommended PC Board Pattern

HOW TO ORDER

M80 - 5 LX XX XX MX

SERIES CODE

TYPE

L1	3mm Tails
L2	4.5mm Tails

TOTAL NO. OF CONTACTS

04, 06, 08, 10, 12, 14, 20, 26, 34, 42, 50

JACKSCREW

MC	101Lok
MD	101Lok with Board Mount

FINISH

05	Gold
42	Gold + Tin

All dimensions in mm.

Datamate J-Tek Connectors

DATAMATE J-TEK

Male Vertical Surface Mount

- Gull wing SMT tails simplify inspection process.
- Board Mount provides PCB strain relief.
- Optional pick and place cap.
- Mates with female Datamate J-Tek connectors with compatible jackscrews.



WITHOUT JACKSCREWS		WITH JACKSCREWS		WITH BOARD MOUNT																													
<p>Recommended PC Board Pattern</p>		<table border="1"> <thead> <tr> <th colspan="2">CALCULATION</th> </tr> </thead> <tbody> <tr> <td>A</td> <td>B + 12</td> </tr> <tr> <td>B</td> <td>Total no. of contacts - 2</td> </tr> <tr> <td>C</td> <td>B + 7</td> </tr> </tbody> </table>		CALCULATION		A	B + 12	B	Total no. of contacts - 2	C	B + 7																						
CALCULATION																																	
A	B + 12																																
B	Total no. of contacts - 2																																
C	B + 7																																
HOW TO ORDER																																	
M80 - 5 XX XX XX P																																	
<table border="1"> <thead> <tr> <th colspan="2">SERIES CODE</th> </tr> </thead> <tbody> <tr> <td>02</td> <td>With Jackscrews</td> </tr> <tr> <td>12</td> <td>With 3.5mm Board Mount</td> </tr> <tr> <td>13</td> <td>With 5mm Board Mount</td> </tr> <tr> <td>22</td> <td>Without Jackscrews</td> </tr> </tbody> </table>		SERIES CODE		02	With Jackscrews	12	With 3.5mm Board Mount	13	With 5mm Board Mount	22	Without Jackscrews	<table border="1"> <thead> <tr> <th colspan="2">PICK AND PLACE CAP</th> </tr> </thead> <tbody> <tr> <td>BLANK</td> <td>No Cap</td> </tr> <tr> <td>P</td> <td>Pick & Place Cap</td> </tr> </tbody> </table>		PICK AND PLACE CAP		BLANK	No Cap	P	Pick & Place Cap	<table border="1"> <thead> <tr> <th colspan="2">FINISH</th> </tr> </thead> <tbody> <tr> <td>05</td> <td>Gold</td> </tr> <tr> <td>42</td> <td>Gold + Tin</td> </tr> </tbody> </table>		FINISH		05	Gold	42	Gold + Tin	<table border="1"> <thead> <tr> <th colspan="2">TOTAL NO. OF CONTACTS</th> </tr> </thead> <tbody> <tr> <td colspan="2">04, 06, 08, 10, 12, 14, 20, 26, 34, 42, 50</td> </tr> </tbody> </table>		TOTAL NO. OF CONTACTS		04, 06, 08, 10, 12, 14, 20, 26, 34, 42, 50	
SERIES CODE																																	
02	With Jackscrews																																
12	With 3.5mm Board Mount																																
13	With 5mm Board Mount																																
22	Without Jackscrews																																
PICK AND PLACE CAP																																	
BLANK	No Cap																																
P	Pick & Place Cap																																
FINISH																																	
05	Gold																																
42	Gold + Tin																																
TOTAL NO. OF CONTACTS																																	
04, 06, 08, 10, 12, 14, 20, 26, 34, 42, 50																																	

All dimensions in mm.

Datamate J-Tek Connectors

DATAMATE J-TEK

Male Vertical Surface Mount 101Lok

- ❖ 101Lok fixing gives secure, fast and simple mating; no special tooling required. Just a simple 101-degree turn is required to fix the connectors together.
- ❖ Connectors mate with Datamate J-Tek female connectors with applicable 101Lok fixings.
- ❖ Board Mount provides PCB strain relief.
- ❖ Gull wing SMT tails simplify inspection process.

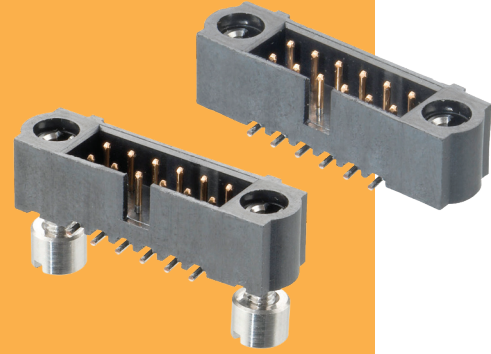

101LOK

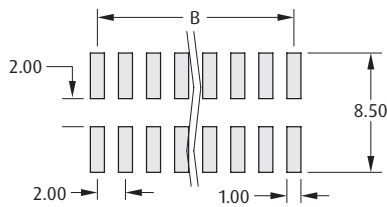
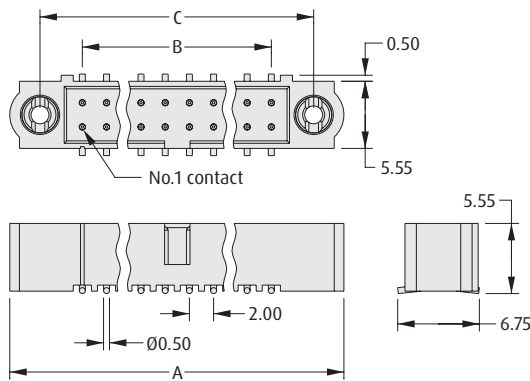

Recommended PC Board Pattern

CALCULATION	
A	$B + 12$
B	Total no. of contacts - 2
C	$B + 7$

101LOK WITH BOARD MOUNT

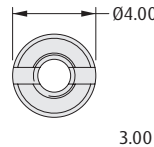
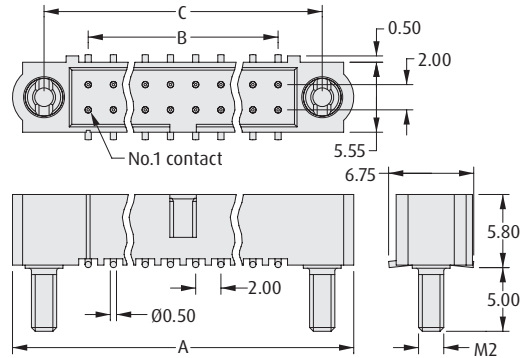

Board Mount Nut,
2 per connector

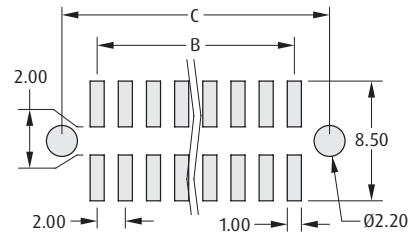

Recommended PC Board Pattern

HOW TO ORDER

M80 - 5S1 XX XX MX

SERIES CODE

TOTAL NO. OF CONTACTS

04, 06, 08, 10, 12, 14, 20, 26, 34, 42, 50

JACKSCREW

MC	101Lok
ME	101Lok with 5mm Board Mount

FINISH

05	Gold
42	Gold + Tin

All dimensions in mm.

Datamate J-Tek Connectors

DATAMATE J-TEK

Male Horizontal Surface Mount

- Stamped contact ensures co-planarity.
- Board Mount provides PCB strain relief.
- Mates with female Datamate J-Tek connectors with compatible jackscrews.

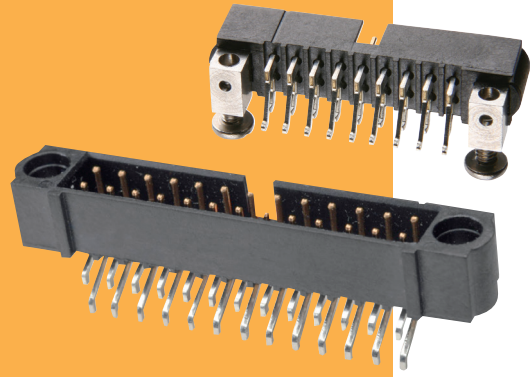

WITHOUT JACKSCREWS		WITH JACKSCREWS		WITH BOARD MOUNT																	
				<p>Board Mount Bolt, 2 per connector</p>																	
				<p>Recommended PC Board Pattern</p>																	
				<p>CALCULATION</p> <table border="1"> <tr> <td>A</td> <td>$B + 12$</td> </tr> <tr> <td>B</td> <td>Total no. of contacts - 2</td> </tr> <tr> <td>C</td> <td>$B + 7$</td> </tr> </table>		A	$B + 12$	B	Total no. of contacts - 2	C	$B + 7$										
A	$B + 12$																				
B	Total no. of contacts - 2																				
C	$B + 7$																				
HOW TO ORDER																					
M80 - 5 XX XX XX																					
<p>SERIES CODE</p>																					
<table border="1"> <thead> <tr> <th colspan="2">TYPE</th> </tr> </thead> <tbody> <tr> <td>32</td> <td>With Jackscrews</td> </tr> <tr> <td>42</td> <td>With 3.5mm Board Mount</td> </tr> <tr> <td>43</td> <td>With 5mm Board Mount</td> </tr> <tr> <td>52</td> <td>Without Jackscrews</td> </tr> </tbody> </table>		TYPE		32	With Jackscrews	42	With 3.5mm Board Mount	43	With 5mm Board Mount	52	Without Jackscrews			<table border="1"> <thead> <tr> <th colspan="2">FINISH</th> </tr> </thead> <tbody> <tr> <td>05</td> <td>Gold</td> </tr> <tr> <td>42</td> <td>Gold + Tin</td> </tr> </tbody> </table>		FINISH		05	Gold	42	Gold + Tin
TYPE																					
32	With Jackscrews																				
42	With 3.5mm Board Mount																				
43	With 5mm Board Mount																				
52	Without Jackscrews																				
FINISH																					
05	Gold																				
42	Gold + Tin																				
				<table border="1"> <thead> <tr> <th colspan="2">TOTAL NO. OF CONTACTS</th> </tr> </thead> <tbody> <tr> <td colspan="2">04, 06, 08, 10, 12, 14, 20, 26, 34, 42, 50</td> </tr> </tbody> </table>		TOTAL NO. OF CONTACTS		04, 06, 08, 10, 12, 14, 20, 26, 34, 42, 50													
TOTAL NO. OF CONTACTS																					
04, 06, 08, 10, 12, 14, 20, 26, 34, 42, 50																					

All dimensions in mm.

Datamate J-Tek Connectors

Male Horizontal Surface Mount 101Lok

- ❖ 101Lok fixing gives secure, fast and simple mating; no special tooling required. Just a simple 101-degree turn is required to fix the connectors together.
- ❖ Connectors mate with Datamate J-Tek female connectors with applicable 101Lok fixings.
- ❖ Board Mount provides PCB strain relief.
- ❖ Stamped contact ensures co-planarity.

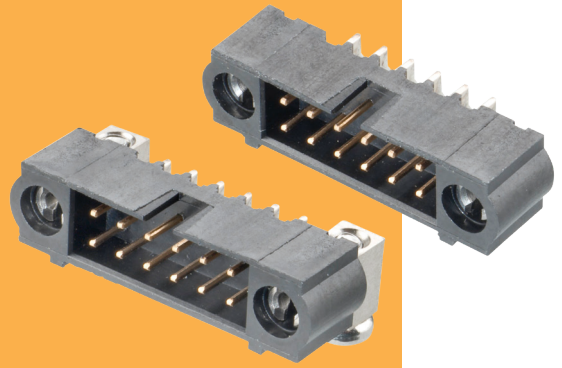

101LOK

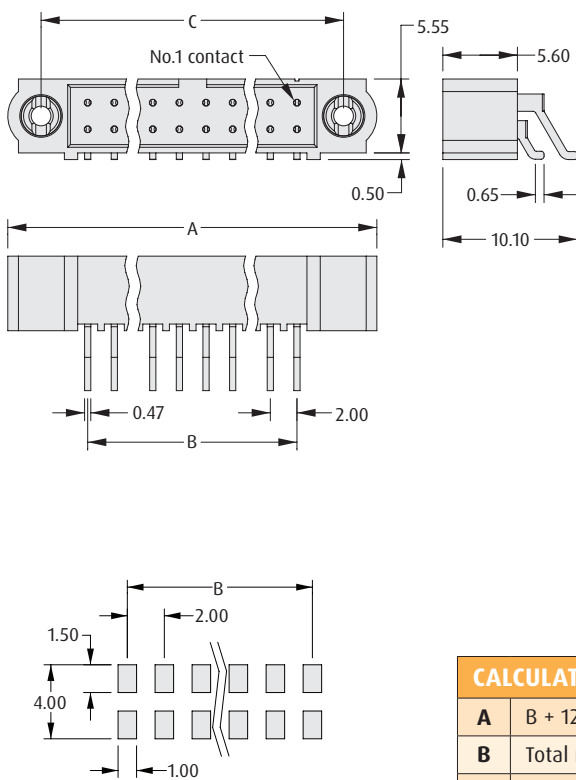

Recommended PC Board Pattern

CALCULATION	
A	$B + 12$
B	Total no. of contacts - 2
C	$B + 7$

101LOK WITH BOARD MOUNT

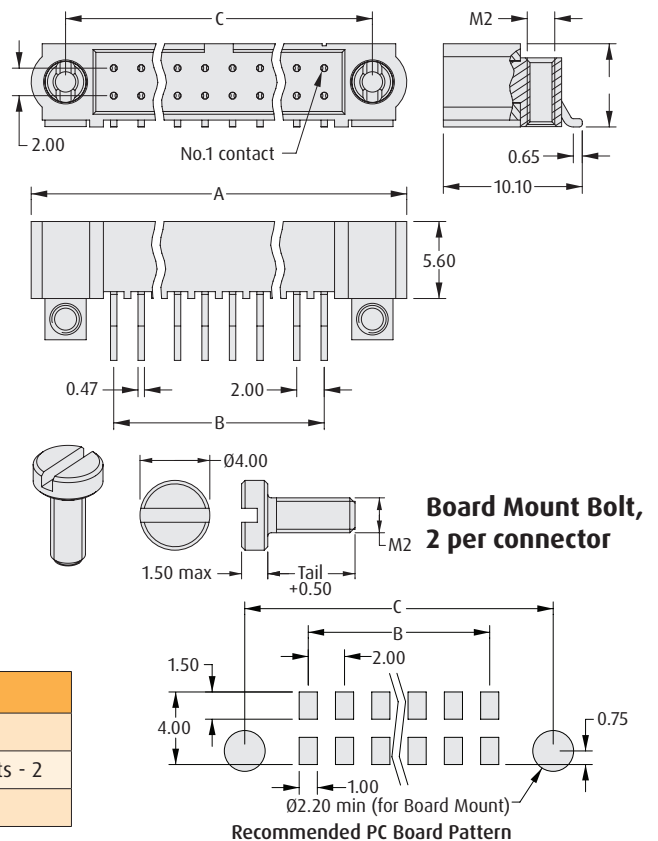

Board Mount Bolt, 2 per connector

Recommended PC Board Pattern

HOW TO ORDER

M80 - 5S2 XX XX MX

SERIES CODE

TOTAL NO. OF CONTACTS

04, 06, 08, 10, 12, 14, 20, 26, 34, 42, 50

JACKSCREW

MC	101Lok
MD	101Lok with Board Mount

FINISH

05	Gold
42	Gold + Tin

All dimensions in mm.

Datamate J-Tek Connectors

DATAMATE J-TEK

Male Crimp Kit

- Part numbers are for a complete kit of a housing and the applicable number of contacts.
- Jackscrews are assembled where specified.
- Crimp contacts supplied loose.
- Crimp contacts are rear insertable and replaceable.
- Spare contacts are available.

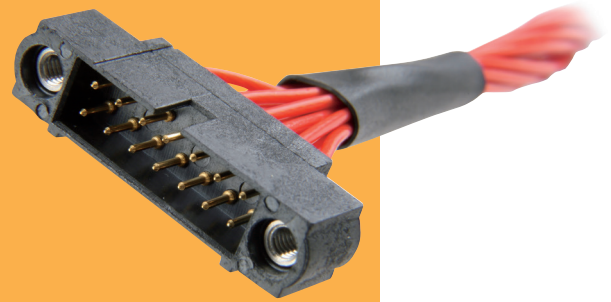

WITHOUT JACKSCREWS	WITH JACKSCREWS																				
<table border="1" style="width: 100%;"> <thead> <tr> <th colspan="2" style="background-color: #f4a460;">CALCULATION</th> </tr> </thead> <tbody> <tr> <td style="width: 30px;">A</td> <td>$B + 12$</td> </tr> <tr> <td>B</td> <td>Total no. of contacts - 2</td> </tr> <tr> <td>C</td> <td>$B + 7$</td> </tr> </tbody> </table>		CALCULATION		A	$B + 12$	B	Total no. of contacts - 2	C	$B + 7$												
CALCULATION																					
A	$B + 12$																				
B	Total no. of contacts - 2																				
C	$B + 7$																				
TOOLS	WIRE STRIPPING DETAILS																				
<p>Recommended Crimp Tool - M22520/2-01</p> <p>Positioner - Z80-193</p> <p>Contact Insertion/Removal Tool - Z80-280</p> <ul style="list-style-type: none"> Spare contacts shown on following pages. Instruction sheets available at www.harwin.com/instructions. 																					
HOW TO ORDER																					
<p>M80 - 5XX XX 05</p>																					
<table border="1" style="width: 100%;"> <thead> <tr> <th colspan="2" style="background-color: #f4a460;">SERIES CODE</th> </tr> </thead> <tbody> <tr> <th style="background-color: #f4a460;">TYPE</th> <td></td> </tr> <tr> <td>570</td> <td>Large Bore (22 AWG), without Jackscrews</td> </tr> <tr> <td>571</td> <td>Small Bore (24-28 AWG), without Jackscrews</td> </tr> <tr> <td>560</td> <td>Large Bore (22 AWG), with Jackscrews</td> </tr> <tr> <td>561</td> <td>Small Bore (24-28 AWG), with Jackscrews</td> </tr> </tbody> </table>	SERIES CODE		TYPE		570	Large Bore (22 AWG), without Jackscrews	571	Small Bore (24-28 AWG), without Jackscrews	560	Large Bore (22 AWG), with Jackscrews	561	Small Bore (24-28 AWG), with Jackscrews	<table border="1" style="width: 100%;"> <thead> <tr> <th colspan="2" style="background-color: #f4a460;">FINISH</th> </tr> </thead> <tbody> <tr> <td style="width: 30px;">05</td> <td>Gold</td> </tr> </tbody> </table> <table border="1" style="width: 100%;"> <thead> <tr> <th colspan="2" style="background-color: #f4a460;">TOTAL NO. OF CONTACTS</th> </tr> </thead> <tbody> <tr> <td colspan="2" style="text-align: center;">04, 06, 08, 10, 12, 14, 20, 26, 34, 42, 50</td> </tr> </tbody> </table>	FINISH		05	Gold	TOTAL NO. OF CONTACTS		04, 06, 08, 10, 12, 14, 20, 26, 34, 42, 50	
SERIES CODE																					
TYPE																					
570	Large Bore (22 AWG), without Jackscrews																				
571	Small Bore (24-28 AWG), without Jackscrews																				
560	Large Bore (22 AWG), with Jackscrews																				
561	Small Bore (24-28 AWG), with Jackscrews																				
FINISH																					
05	Gold																				
TOTAL NO. OF CONTACTS																					
04, 06, 08, 10, 12, 14, 20, 26, 34, 42, 50																					

All dimensions in mm.

Datamate J-Tek Connectors

Male Crimp Kit 101Lok

- ❖ Part numbers are for a complete kit of a housing and the applicable number of contacts.
- ❖ 101Lok fixing gives secure, fast and simple mating; no special tooling required. Just a simple 101-degree turn is required to fix the connectors together.
- ❖ Connectors mate with Datamate J-Tek female connectors with applicable 101Lok fixings.
- ❖ Crimp contacts supplied loose.

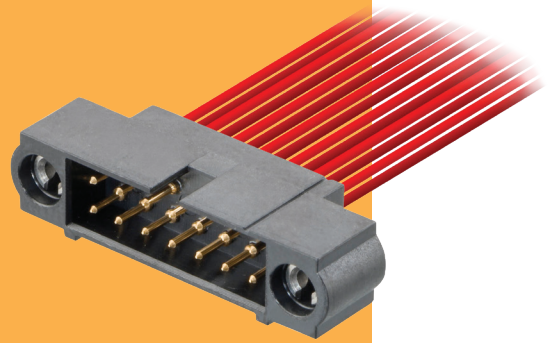

DATAMATE J-TEK

101LOK		CALCULATION	
		A	$B + 12$
		B	Total no. of contacts - 2
		C	$B + 7$
TOOLS		WIRE STRIPPING DETAILS	
<p>Recommended Crimp Tool - M22520/2-01</p> <p>Positioner - Z80-193</p> <p>Contact Insertion/Removal Tool - Z80-280</p> <ul style="list-style-type: none"> ❖ Spare contacts shown on following pages. ❖ Instruction sheets available at www.harwin.com/instructions. 			
HOW TO ORDER			
M80 - 5 X1 XX 05 MC			
SERIES CODE			JACKSCREW
TYPE			MC 101Lok
C1 Small Bore (24-28 AWG)			
D1 Large Bore (22 AWG)			
TOTAL NO. OF CONTACTS			FINISH
04, 06, 08, 10, 12, 14, 20, 26, 34, 42, 50			05 Gold

All dimensions in mm.

Datamate J-Tek Connectors

DATAMATE J-TEK

Male Crimp Kit Reverse Fix

- Allows for further flexibility in system design.
- Part numbers are for a complete kit of a housing and the applicable number of contacts.
- Crimp contacts are rear insertable and replaceable.
- Mates with female Datamate J-Tek connectors with compatible Reverse Fix jackscrews.

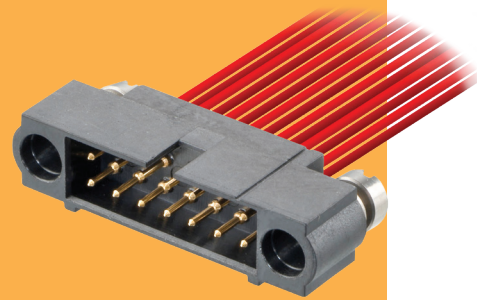

REVERSE FIX		CALCULATION													
		A	$B + 12$												
		B	Total no. of contacts - 2												
		C	$B + 7$												
TOOLS		WIRE STRIPPING DETAILS													
<p>Recommended Crimp Tool - M22520/2-01</p> <p>Positioner - Z80-193</p> <p>Contact Insertion/Removal Tool - Z80-280</p> <ul style="list-style-type: none"> Spare contacts shown on following pages. Instruction sheets available at www.harwin.com/instructions. 															
HOW TO ORDER															
M80 - 5XX XX 05															
<p>SERIES CODE</p> <table border="1"> <thead> <tr> <th colspan="2">TYPE</th> </tr> </thead> <tbody> <tr> <td>562</td> <td>Large Bore (22 AWG), Slotted Jackscrew</td> </tr> <tr> <td>563</td> <td>Small Bore (24-28 AWG), Slotted Jackscrew</td> </tr> <tr> <td>582</td> <td>Large Bore (22 AWG), Hex Socket Jackscrew</td> </tr> <tr> <td>583</td> <td>Small Bore (24-28 AWG), Hex Socket Jackscrew</td> </tr> </tbody> </table>		TYPE		562	Large Bore (22 AWG), Slotted Jackscrew	563	Small Bore (24-28 AWG), Slotted Jackscrew	582	Large Bore (22 AWG), Hex Socket Jackscrew	583	Small Bore (24-28 AWG), Hex Socket Jackscrew	<p>FINISH</p> <table border="1"> <tbody> <tr> <td>05</td> <td>Gold</td> </tr> </tbody> </table>		05	Gold
TYPE															
562	Large Bore (22 AWG), Slotted Jackscrew														
563	Small Bore (24-28 AWG), Slotted Jackscrew														
582	Large Bore (22 AWG), Hex Socket Jackscrew														
583	Small Bore (24-28 AWG), Hex Socket Jackscrew														
05	Gold														
		<p>TOTAL NO. OF CONTACTS</p> <p>04, 06, 08, 10, 12, 14, 20, 26, 34, 42, 50</p>													

All dimensions in mm.

Datamate J-Tek Connectors

Male Crimp Kit Extended Wall

- Extended Wall Datamate allows back potting to be performed.
- Fully shrouded contacts.
- Large Bore 22 AWG, Small Bore 24 – 28 AWG.
- Part numbers are for a complete kit of a housing and the applicable number of contacts.
- Crimp contacts are rear insertable and replaceable.
- Crimp contacts supplied loose.

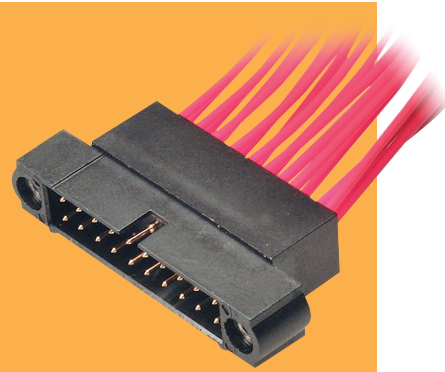

DATAMATE J-TEK

WITHOUT JACKSCREWS	WITH JACKSCREWS														
<div style="border: 1px solid black; padding: 5px; margin-top: 10px;"> <p>CALCULATION</p> <table border="1"> <tr> <td>A</td> <td>$B + 12$</td> </tr> <tr> <td>B</td> <td>Total no. of contacts - 2</td> </tr> <tr> <td>C</td> <td>$B + 7$</td> </tr> </table> </div>	A	$B + 12$	B	Total no. of contacts - 2	C	$B + 7$									
A	$B + 12$														
B	Total no. of contacts - 2														
C	$B + 7$														
TOOLS	WIRE STRIPPING DETAILS														
<p>Recommended Crimp Tool - M22520/2-01</p> <p>Positioner - Z80-193</p> <p>Contact Insertion/Removal Tool - Z80-280</p> <ul style="list-style-type: none"> Spare contacts shown on following pages. Instruction sheets available at www.harwin.com/instructions. 															
HOW TO ORDER															
<p>M80 - 5XX XX 05 X</p>															
<p>SERIES CODE</p>	<table border="1" style="background-color: #f4a460;"> <tr> <th colspan="2">WALL SIZE</th> </tr> <tr> <td>BLANK</td> <td>Wall = 5mm</td> </tr> <tr> <td>A</td> <td>Wall = 1mm</td> </tr> </table>	WALL SIZE		BLANK	Wall = 5mm	A	Wall = 1mm								
WALL SIZE															
BLANK	Wall = 5mm														
A	Wall = 1mm														
<table border="1" style="background-color: #f4a460;"> <tr> <th colspan="2">TYPE</th> </tr> <tr> <td>575</td> <td>Large Bore (22 AWG), without Jackscrews</td> </tr> <tr> <td>576</td> <td>Small Bore (24-28 AWG), without Jackscrews</td> </tr> <tr> <td>565</td> <td>Large Bore (22 AWG), with Jackscrews</td> </tr> <tr> <td>566</td> <td>Small Bore (24-28 AWG), with Jackscrews</td> </tr> </table>	TYPE		575	Large Bore (22 AWG), without Jackscrews	576	Small Bore (24-28 AWG), without Jackscrews	565	Large Bore (22 AWG), with Jackscrews	566	Small Bore (24-28 AWG), with Jackscrews	<table border="1" style="background-color: #f4a460;"> <tr> <th colspan="2">FINISH</th> </tr> <tr> <td>05</td> <td>Gold</td> </tr> </table>	FINISH		05	Gold
TYPE															
575	Large Bore (22 AWG), without Jackscrews														
576	Small Bore (24-28 AWG), without Jackscrews														
565	Large Bore (22 AWG), with Jackscrews														
566	Small Bore (24-28 AWG), with Jackscrews														
FINISH															
05	Gold														
	<table border="1" style="background-color: #f4a460;"> <tr> <th>TOTAL NO. OF CONTACTS</th> </tr> <tr> <td>06, 10, 14, 20, 26, 34</td> </tr> </table>	TOTAL NO. OF CONTACTS	06, 10, 14, 20, 26, 34												
TOTAL NO. OF CONTACTS															
06, 10, 14, 20, 26, 34															

All dimensions in mm.

Datamate J-Tek Connectors

DATAMATE J-TEK

Male Crimp with Hood

- Supplied as a complete kit: jackscrews assembled to housing; hood, contacts and assembly screws supplied loose.
- Provides strain relief by preventing cable bending at the rear of the connector, and also the option of inserting a cable tie to reduce pull strain.

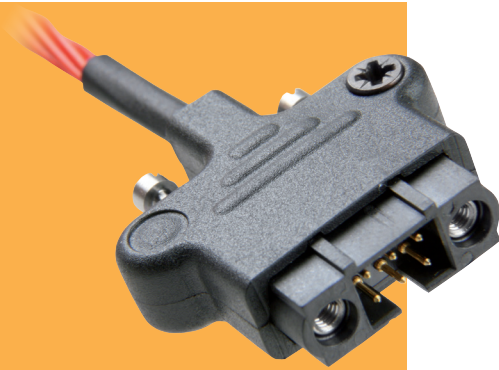

MALE		CALCULATION	
		A	$B + 21.5$
		B	Total no. of contacts - 2
		C	$B + 7$
TOOLS		WIRE STRIPPING DETAILS	
<p>Recommended Crimp Tool - M22520/2-01</p> <p>Positioner - Z80-193</p> <p>Contact Insertion/Removal Tool - Z80-280</p> <ul style="list-style-type: none"> ➤ Spare contacts shown on following pages. ➤ Instruction sheets available at www.harwin.com/instructions. 			
HOW TO ORDER			
M80 - 94 X XX 05			
SERIES CODE		FINISH	05 Gold
TYPE		TOTAL NO. OF CONTACTS	06, 08, 10, 12, 14, 20, 26, 34, 42, 50
2 Small Bore (24-28 AWG)			
3 Large Bore (22 AWG)			

All dimensions in mm.

Datamate J-Tek Connectors

Spare Male Crimp Contacts

- Barrel Crimp Contacts are supplied with the connectors - see previous page. Use the order code for extra spare crimps.

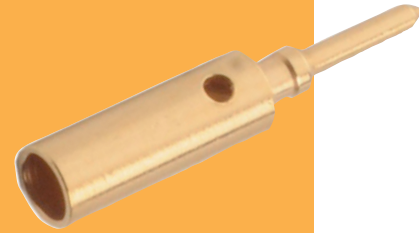

DATAMATE J-TEK

CRIMP CONTACTS	WIRE STRIPPING DETAILS						
<p>Large Bore (22 AWG)</p>							
<p>Small Bore (24 to 28 AWG)</p>							
TOOLS							
<p>Recommended Crimp Tool - M22520/2-01 Positioner - Z80-193 Contact Insertion/Removal Tool - Z80-280</p> <p>❖ Instruction sheets available at www.harwin.com/instructions.</p>							
HOW TO ORDER							
<p>M80 - 19 X 00 05</p>							
<p>SERIES CODE</p>	<p>FINISH</p> <table border="1"> <tr> <td>05</td> <td>Gold</td> </tr> </table>	05	Gold				
05	Gold						
<table border="1"> <thead> <tr> <th colspan="2">TYPE</th> </tr> </thead> <tbody> <tr> <td>4</td> <td>Large Bore (22 AWG)</td> </tr> <tr> <td>5</td> <td>Small Bore (24-28 AWG)</td> </tr> </tbody> </table>	TYPE		4	Large Bore (22 AWG)	5	Small Bore (24-28 AWG)	
TYPE							
4	Large Bore (22 AWG)						
5	Small Bore (24-28 AWG)						

All dimensions in mm.

Datamate J-Tek Connectors

Male Cable Assemblies

- Ready-made cable assemblies, fully tested and inspected.
- Stainless steel jackscrews to mate with applicable male connector.
- Constructed with Contact 1 to Contact 1, Contact 2 to Contact 2, etc.
- For multicolor sequence, check applicable Technical Drawing.

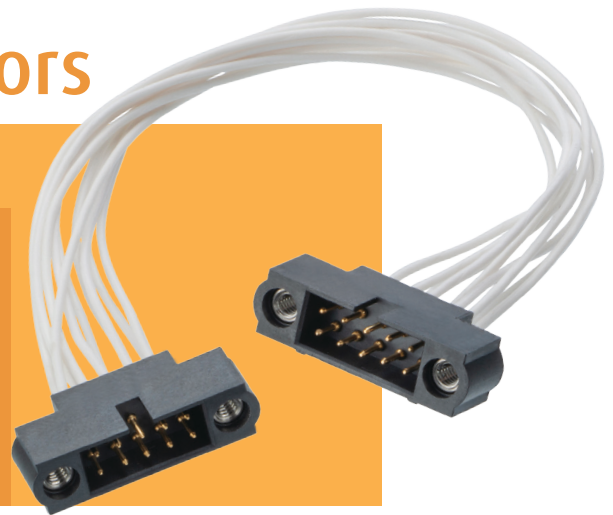

PART NUMBERING SYSTEM

M80 - M X X XX XX MX - XXXX XX

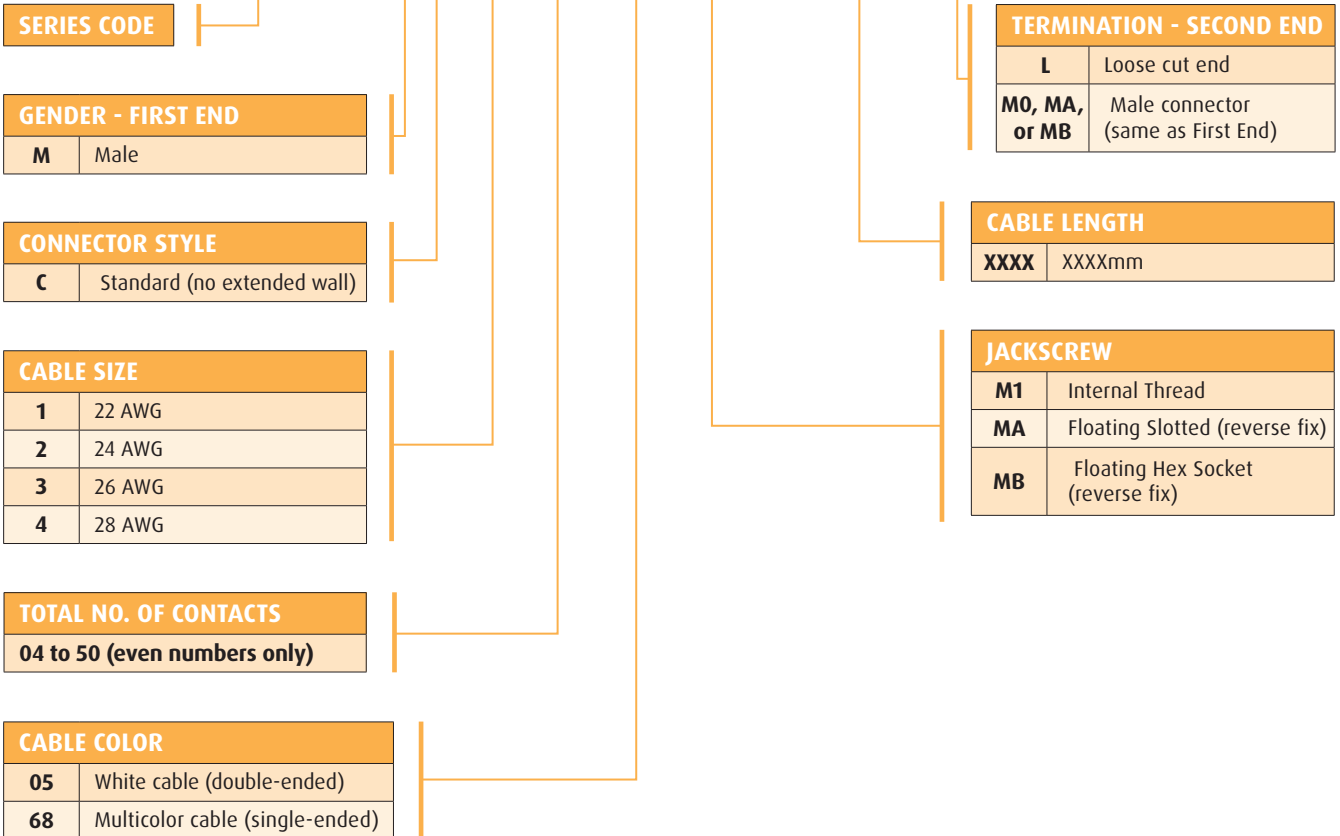

All dimensions in mm.

Datamate J-Tek Connectors

- ❖ Examples of available cable assembly options - see previous page for part numbering.
- ❖ Cable assemblies are constructed with Contact 1 to Contact 1, Contact 2 to Contact 2, etc.

MALE SINGLE ENDED

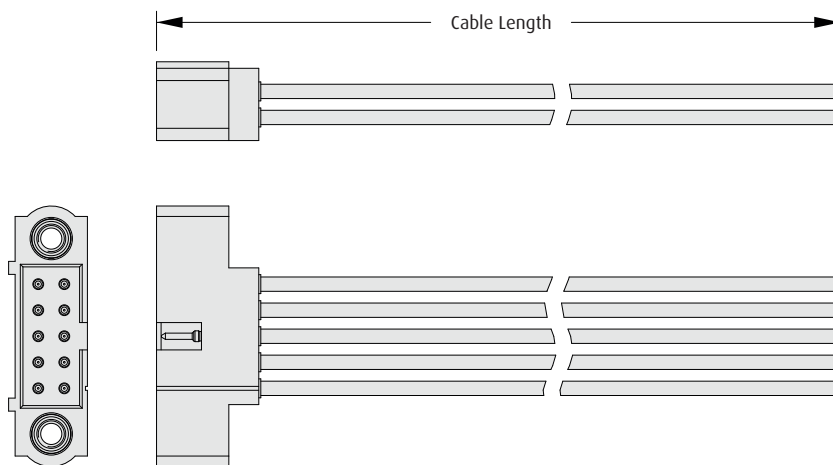

MALE - MALE

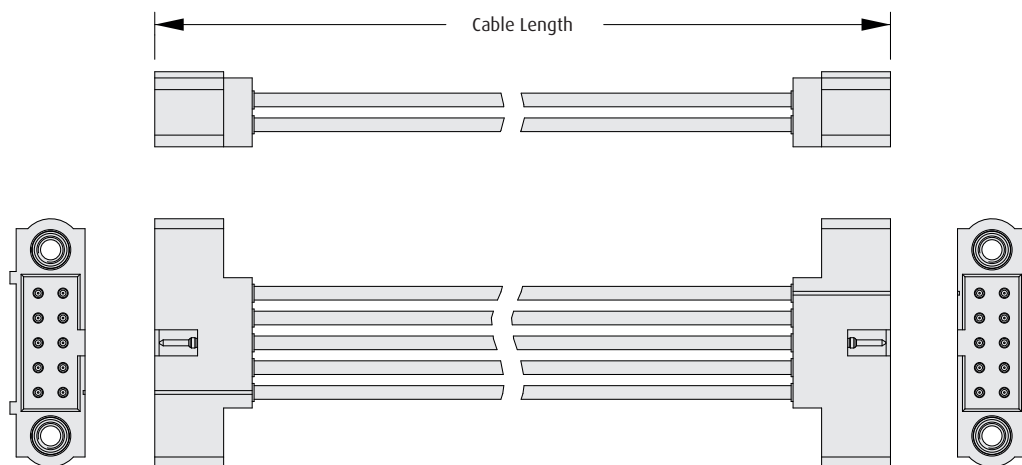

All dimensions in mm.

Datamate J-Tek Connectors

Male Metal Backshell

- ❖ Supplied as an accessory, to be used with existing male connectors.
- ❖ Can be fitted to either male vertical PCB connectors with board mount, or male cable connectors with panel mount jackscrews.
- ❖ Gives 360 degree shielding when mounted to a conductive panel and mated to a compatible female connector with metal backshell.



DATAMATE J-TEK

MALE		CALCULATION	
	A	$B + 13.7$	
	B	Equivalent no. of contacts - 2	
	C	$B + 7$	
	D	$B + 2.8$	

HOW TO ORDER

M80 - 906 XX 02

SERIES CODE	FINISH	
	02	Nickel

EQUIVALENT NO. OF SIGNAL CONTACTS	
08 to 28, 32 to 50 (Even numbers only)	

All dimensions in mm.

Datamate J-Tek Connectors

Flexible Circuit Assemblies

- ❖ Surface mount connectors with jackscrews, assembled to flexible printed circuit for an alternative to cable connection.
- ❖ Improved bend radius and lower mated height than equivalent cable assemblies.
- ❖ The free end of the single-ended assembly is compatible with 1mm pitch FPC connectors.
- ❖ Contact Harwin for alternative connector sizes and cable lengths.

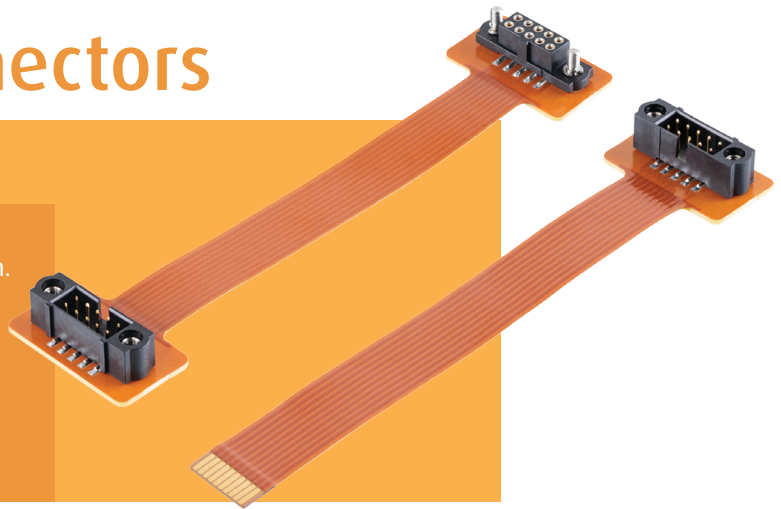

DATAMATE J-TEK

MALE SINGLE ENDED

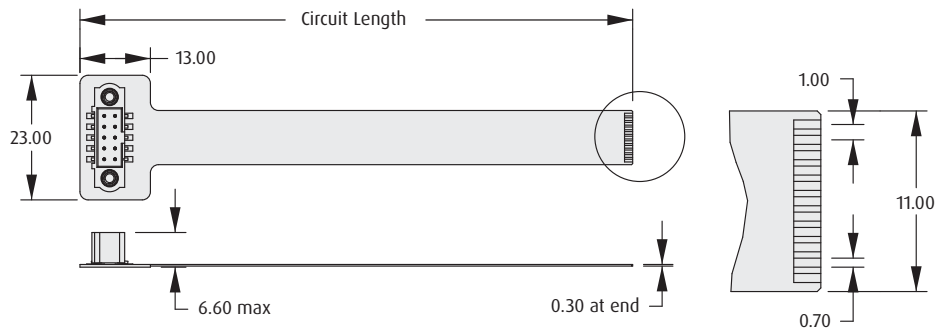

MALE - FEMALE DOUBLE ENDED

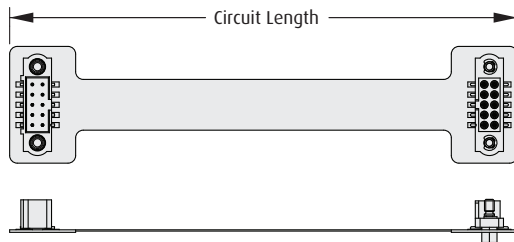

HOW TO ORDER

M80 - F1 502 10 - 100 - XXX

SERIES CODE	M80	CONNECTOR - FIRST END	F1	TOTAL NO. OF CONTACTS	10	CONNECTOR - SECOND END	L	Free End (Single Ended)
		502	Male with internal jackscrews			402	Female with Hex Slotted Jackscrews	
						CIRCUIT LENGTH	100	100mm

All dimensions in mm.

Datamate J-Tek 3-Row Specification

Materials

Housings:	Glass-filled thermoplastic UL94V-0
Female contacts:	Brass shell, with Beryllium Copper inner contact
Male contacts:	Phosphor bronze
Finish:	Gold

Electrical

Current	
Individual contacts in isolation:	3.3A max (at 25°C) 2.6A max (at 85°C)
All contacts simultaneously:	3.0A max (at 25°C) 2.2A max (at 85°C)
Working voltage	
At sea level 1013 mbar:	800V DC or AC _{rms}
Voltage proof	
At sea level 1013 mbar:	1,200V DC or AC _{rms}
Contact resistance	
Initial:	20mΩ max
After conditioning:	25mΩ max
Insulation resistance	
Initial:	1000MΩ min
After conditioning:	100MΩ min

Mechanical

Durability:	500 operations
Insertion force (max):	1.0N
Withdrawal force (min):	0.2N
Signal crimp accommodation:	22 AWG to 28 AWG BS 3G 210 Type A or MIL-DTL-16878/6 Type ET

Environmental

Environmental classification:	55/125/56 days at 95% RH
Operational temperature:	-55°C to +125°C
*Vibration sensitivity:	10Hz to 2000Hz, 0.75mm, 98m/s ² (10G), duration 6h
*Bump severity:	390m/s ² (40G), 4000 ±10 bumps
*Shock severity:	981m/s ² (100G) for 6ms
*Acceleration severity:	490m/s ² (50G)

* Tested with connectors with Jackscrews.

Pin Numbering

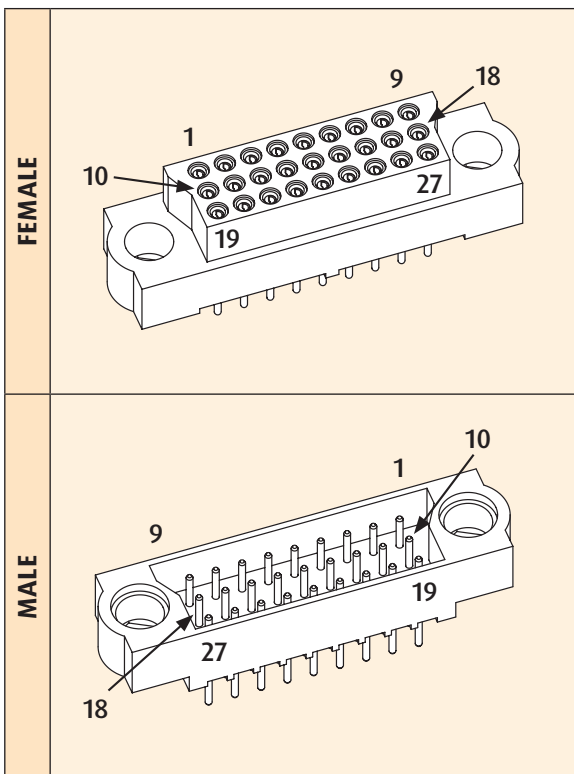

All dimensions in mm.

Mating Profiles

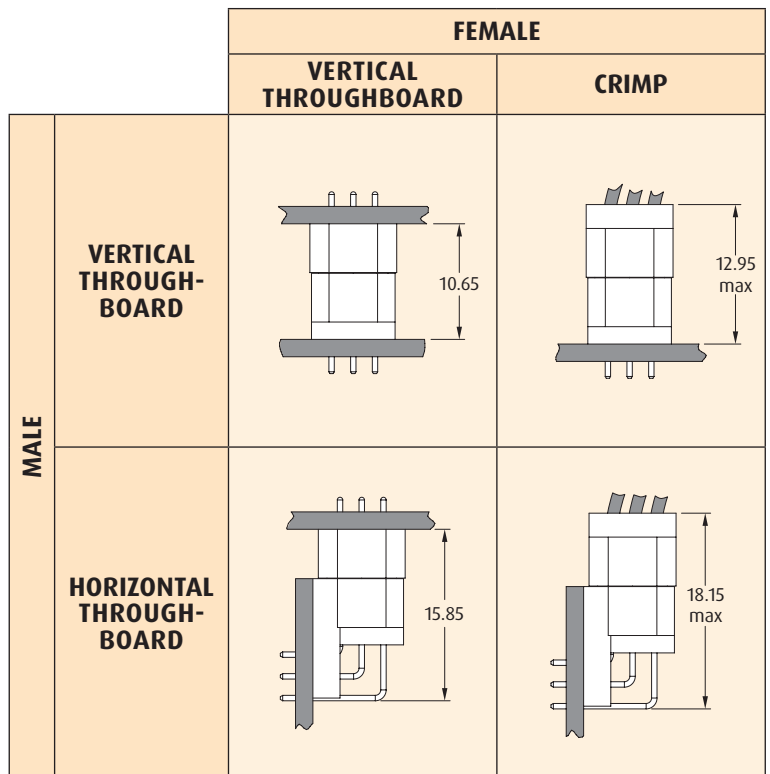

Datamate J-Tek 3-Row Connectors

Female Vertical Throughboard

- ❖ Low-force 4-finger Beryllium Copper contact clip.
- ❖ Fully shrouded contacts.
- ❖ Polarized housings.
- ❖ All contacts are gold finish for full RoHS compliance.
- ❖ Mates with all Datamate 3-Row male connectors with compatible jackscrews.

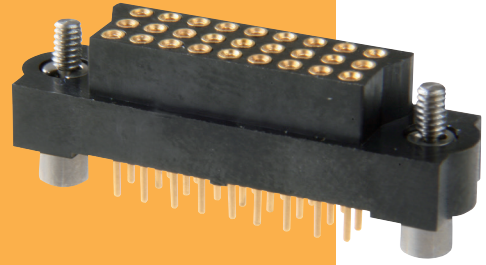

DATAMATE J-TEK 3-ROW

THROUGHBOARD

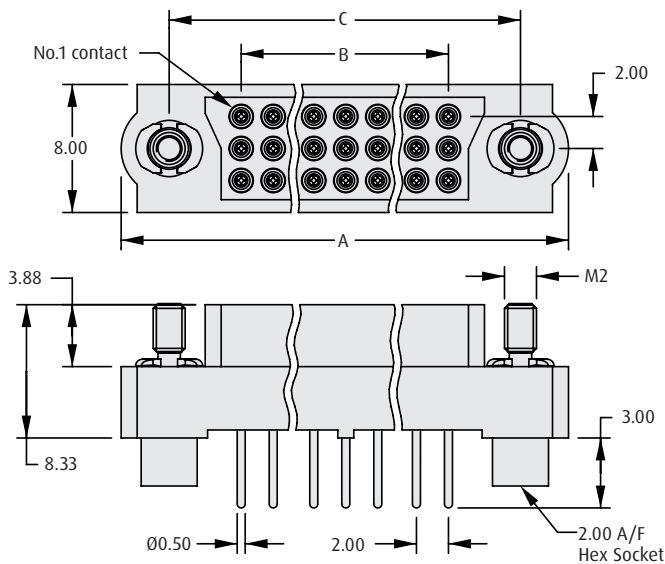

CALCULATION

A	$B + 15$
B	$(\text{Total no. of contacts} - 3) \times 2/3$
C	$B + 9$

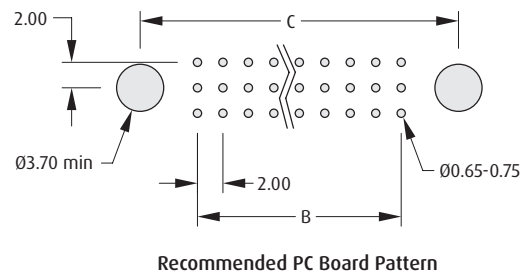

HOW TO ORDER

M83 - LF T1 F2 N XX - 0000 - 000

SERIES CODE

TYPE

T1 3mm Tail

TOTAL NO. OF CONTACTS

18, 27, 36, 54, 60, 96

JACKSCREW

F2 Hex Socket Jackscrew

All dimensions in mm.

Datamate J-Tek 3-Row Connectors

DATAMATE J-TEK 3-ROW

Female Crimp Kit

- Part numbers are for a complete kit of a housing and the applicable number of contacts.
- Jackscrews are assembled where specified.
- Crimp contacts are rear insertable.
- Low-force 4-finger Beryllium Copper contact clip.
- Spare contacts are available.

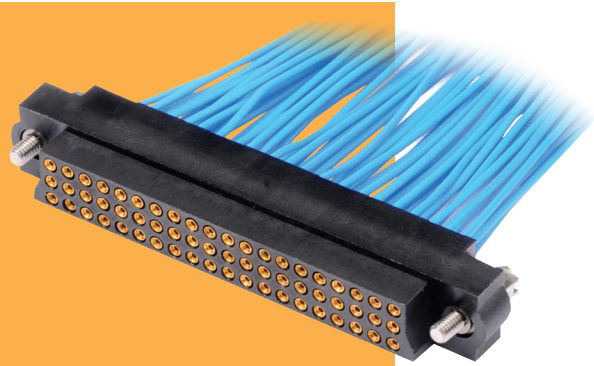

FEMALE CRIMP

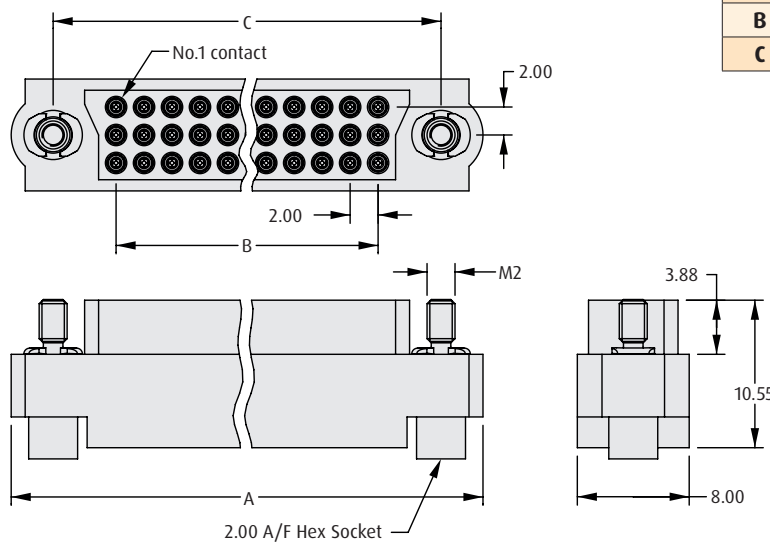

CALCULATION

A	B + 15
B	(Total no. of contacts - 3) x 2/3
C	B + 9

TOOLS

Recommended Crimp Tool - M22520/2-01
Positioner - T5747
Contact Insertion/Removal Tool - Z80-280

- Spare contacts shown on following pages.
- Instruction sheets available at www.harwin.com/instructions.

WIRE STRIPPING DETAILS

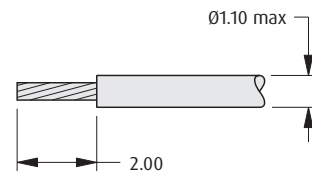

HOW TO ORDER

M83 - LF X1 F2 N XX - 0000 - 000

SERIES CODE

TYPE

C1	Small Bore (24-28 AWG)
D1	Large Bore (22 AWG)

TOTAL NO. OF CONTACTS

18, 27, 36, 54, 60, 96

JACKSCREW

F2 Hex Socket Jackscrew

All dimensions in mm.

Datamate J-Tek 3-Row Connectors

Spare Female Crimp Contacts

- Barrel Crimp Contacts are supplied with the connectors - see previous page. Use the order code for extra spare crimps.



DATAMATE J-TEK 3-ROW

CRIMP CONTACTS	WIRE STRIPPING DETAILS								
<p>Large Bore (22 AWG)</p> <p>7.45</p> <p>2 x Ident Grooves</p> <p>Small Bore (24 to 28 AWG)</p> <p>3 x Ident Grooves</p>	<p>Ø1.10 max</p> <p>2.00</p>								
	TOOLS								
	<p>Recommended Crimp Tool - M22520/2-01 Positioner - T5747 Contact Insertion/Removal Tool - Z80-280</p> <p>❖ Instruction sheets available at www.harwin.com/instructions.</p>								
HOW TO ORDER									
<p>M83 - 01X 00 05</p>									
<p>SERIES CODE</p> <table border="1" style="width: 100%;"> <thead> <tr> <th colspan="2" style="background-color: #f4a460;">TYPE</th> </tr> </thead> <tbody> <tr> <td style="background-color: #f4a460;">011</td> <td>Large Bore (22 AWG)</td> </tr> <tr> <td style="background-color: #f4a460;">013</td> <td>Small Bore (24-28 AWG)</td> </tr> </tbody> </table>	TYPE		011	Large Bore (22 AWG)	013	Small Bore (24-28 AWG)	<p>FINISH</p> <table border="1" style="width: 100%;"> <tbody> <tr> <td style="background-color: #f4a460;">05</td> <td>Gold</td> </tr> </tbody> </table>	05	Gold
TYPE									
011	Large Bore (22 AWG)								
013	Small Bore (24-28 AWG)								
05	Gold								

All dimensions in mm.

Datamate J-Tek 3-Row Connectors

DATAMATE J-TEK 3-RW

Male Vertical Throughboard

- Board Mount nuts to be tightened to a maximum torque of 23cmN.
- Fully shrouded contacts.
- Polarized housings.
- All contacts are gold finish for full RoHS compliance.
- Mates with all Datamate 3-Row female connectors with compatible jackscrews.

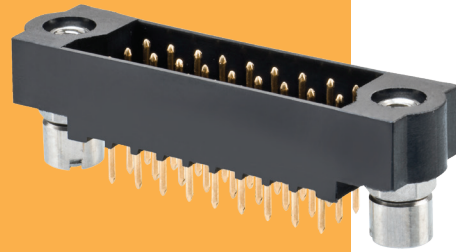

MALE VERTICAL

CALCULATION

A	B + 15
B	(Total no. of contacts - 3) x 2/3
C	B + 9

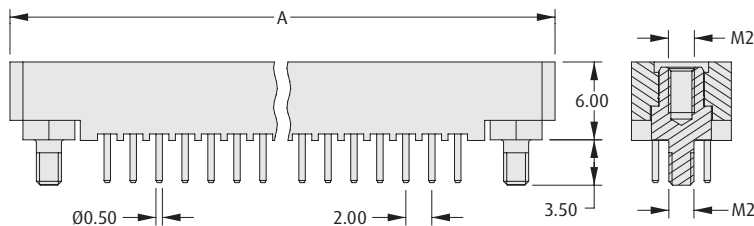
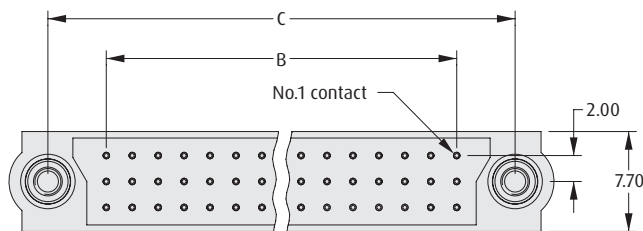

Board Mount Nut, 2 per connector

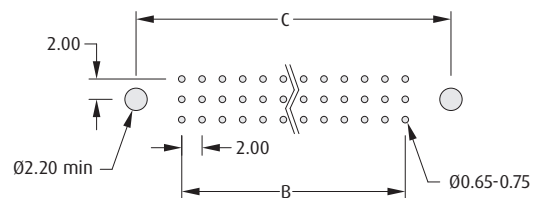
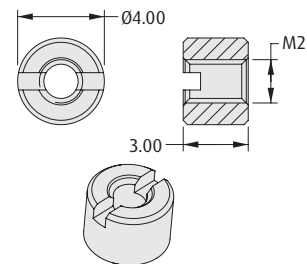

Recommended PC Board Pattern

HOW TO ORDER

M83 - LM T1 M2 N XX - 0000 - 000

SERIES CODE	M83 - LM	TOTAL NO. OF CONTACTS	18, 27, 36, 54, 60, 96
TYPE	T1 3mm Tail	JACKSCREW	M2 Board Mount Jackscrew

All dimensions in mm.

Datamate J-Tek 3-Row Connectors

Male Horizontal Throughboard

- Board Mount jackscrews provide PCB strain relief. Hex socket bolts are included, and are supplied loose - tighten to a maximum torque of 23cmN.
- Suitable for motherboard/daughterboard configurations.
- Fully shrouded contacts, polarized housings.
- All contacts are gold finish for full RoHS compliance.
- Mates with all Datamate 3-Row female connectors with compatible standard gender jackscrews.

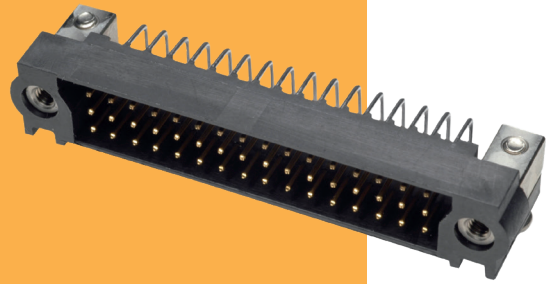

DATAMATE J-TEK 3-ROW

MALE HORIZONTAL

CALCULATION

A	B + 15
B	(Total no. of contacts - 3) x 2/3
C	B + 9

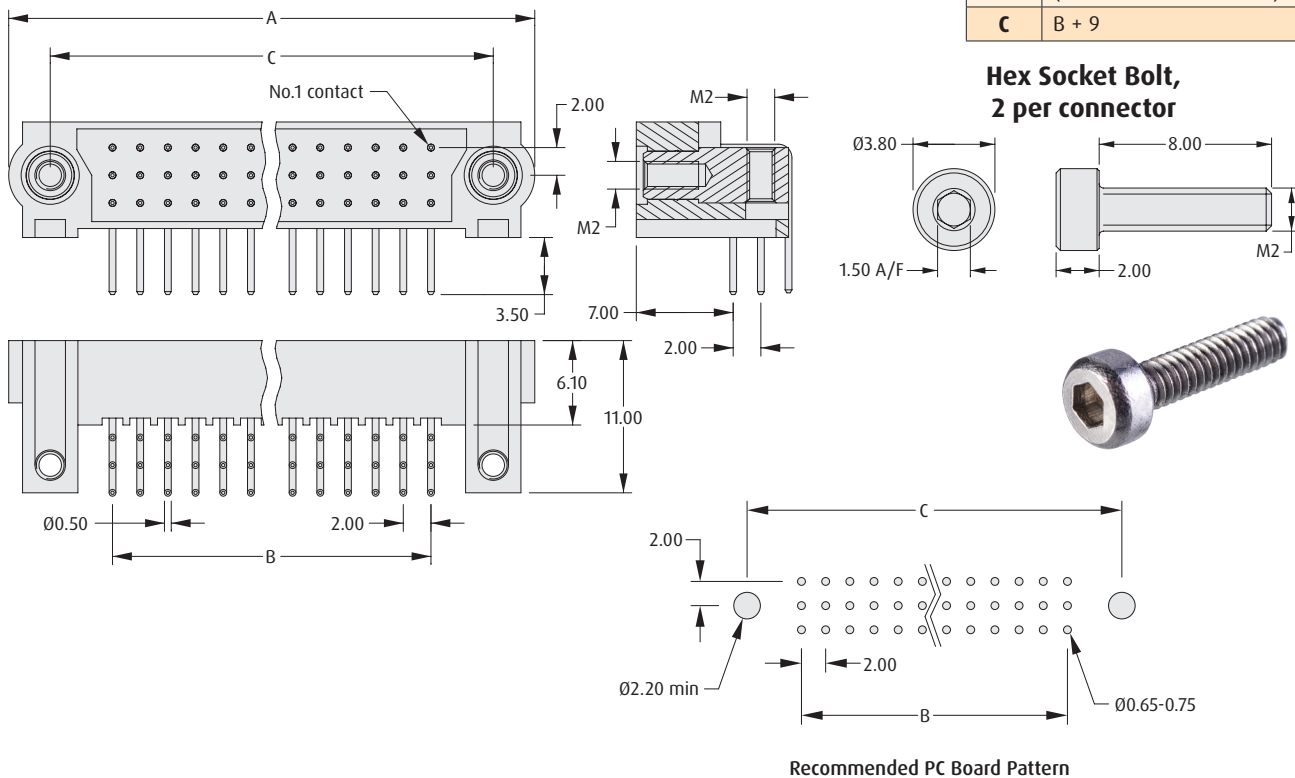

HOW TO ORDER

M83 - LM L3 M7 N XX - 0000 - 000

SERIES CODE

TYPE

L3 3.5mm Tails

TOTAL NO. OF CONTACTS

18, 27, 36, 54, 60, 96

JACKSCREW

M7 Hex Socket Board Mount

All dimensions in mm.

Datamate L-Tek Specification

Materials

Housings:	Glass-filled thermoplastic UL94V-0
Female contacts:	Brass shell, with Beryllium Copper inner contact
Male contacts:	Copper alloy
Finish:	See individual pages

Mechanical

Durability:	500 operations
Insertion force (max):	2.8N
Withdrawal force (min):	0.2N
Signal crimp accommodation:	22 AWG to 32 AWG BS 3G 210 Type A, MIL-W-16878

Electrical

Current	
Individual contacts in isolation:	3.3A max (at 25°C) 2.6A max (at 85°C)
All contacts simultaneously:	3.0A max (at 25°C) 2.2A max (at 85°C)
Working voltage	
At sea level 1013 mbar:	800V DC or AC _{rms}
Voltage proof	
At sea level 1013 mbar:	1,200V DC or AC _{rms}
Contact resistance	
Initial:	20mΩ max
After conditioning:	25mΩ max
Insulation resistance	
Initial:	1,000MΩ min
After conditioning:	100MΩ min

Environmental

Environmental classification:	55/125/56 days at 95% RH
Operational temperature:	-55°C to +125°C
*Vibration sensitivity:	10Hz to 2000Hz, 0.75mm, 98m/s ² (10G), duration 6h
*Bump severity:	390m/s ² (40G), 4000 ±10 bumps
*Shock severity:	981m/s ² (100G) for 6ms
*Acceleration severity:	490m/s ² (50G)

* Tested with latched connectors.

Pin Numbering

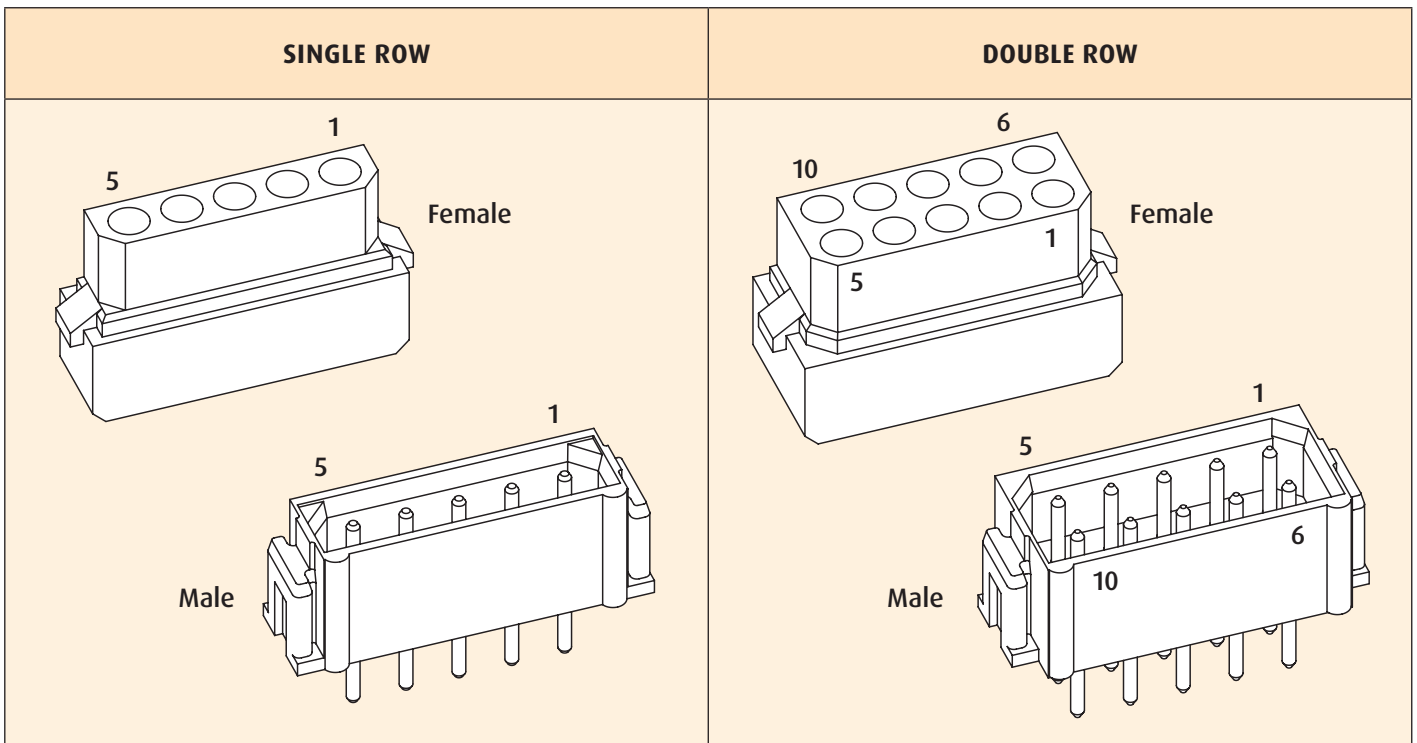

All dimensions in mm.

Datamate L-Tek Mating Profiles

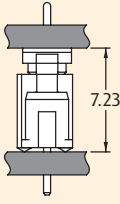
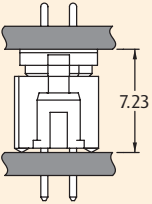
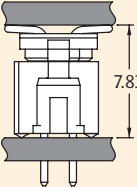
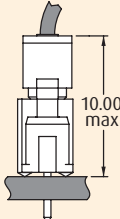
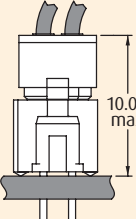
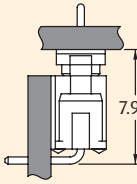
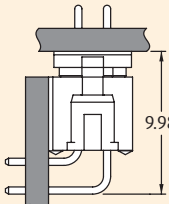
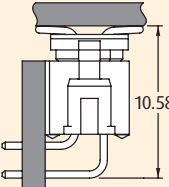
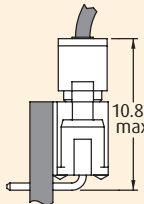
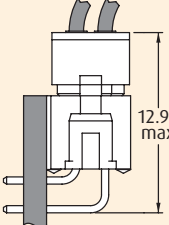
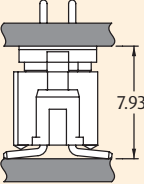
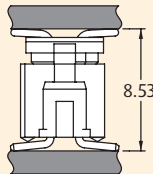
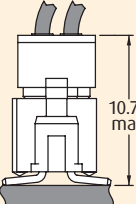
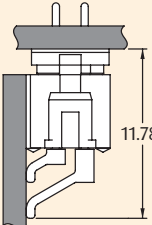
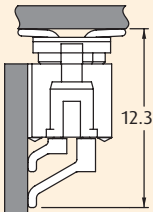
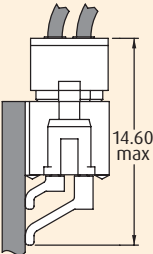
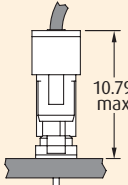
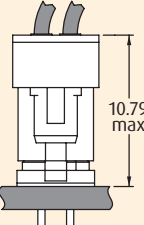
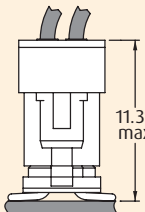
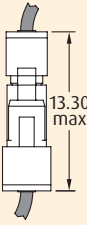
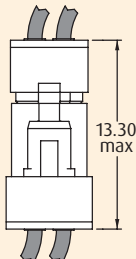
		FEMALE				
		VERTICAL THROUGHBOARD		VERTICAL SMT	CRIMP	
		SIL	DIL	DIL	SIL	DIL
MALE	VERTICAL THROUGHBOARD	 7.23	 7.23	 7.83	 10.00 max	 10.00 max
	HORIZONTAL THROUGHBOARD	 7.98	 9.98	 10.58	 10.85 max	 12.95 max
	VERTICAL SMT		 7.93	 8.53		 10.75 max
	HORIZONTAL SMT		 11.78	 12.38		 14.60 max
	CRIMP	 10.79 max	 10.79 max	 11.39 max	 13.30 max	 13.30 max

All dimensions in mm.

Datamate L-Tek Connectors

DATAMATE L-TEK

Female Vertical Throughboard

- Polarized housings.
- Dummy contacts are available for additional polarization, use **order code M80-023**.

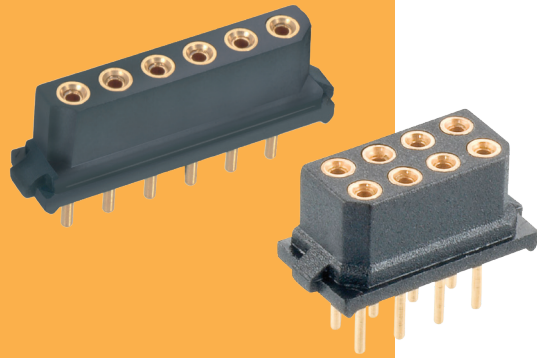

SINGLE ROW

CALCULATION

A	$B + 5.15$
B	$(\text{Total no. of contacts} - 1) \times 2$

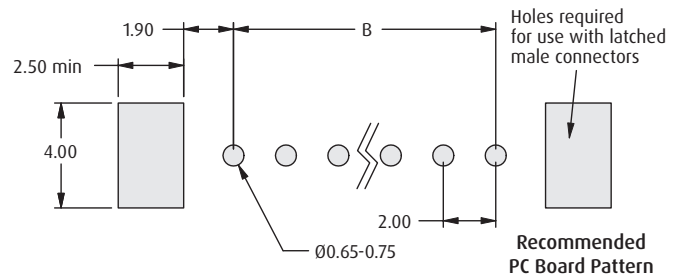
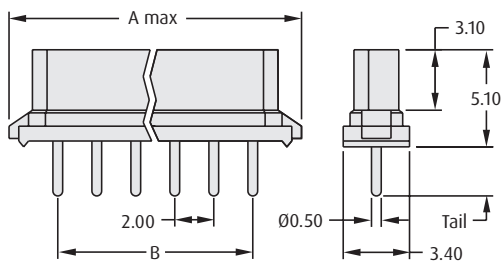

DOUBLE ROW

CALCULATION

A	$B + 5.15$
B	$\text{Total no. of contacts} - 2$

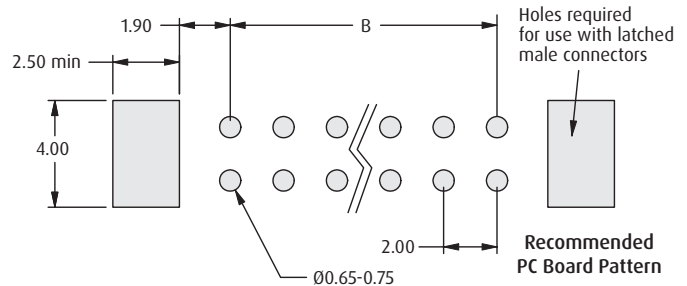
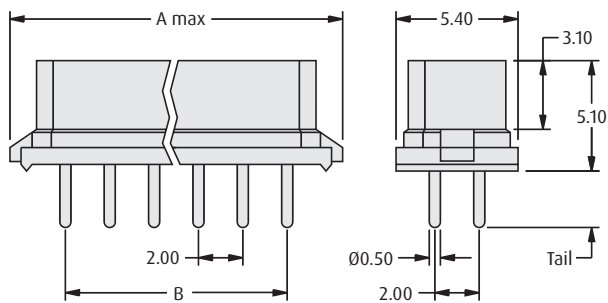

HOW TO ORDER

M80 - XXX XX XX

SERIES CODE

TYPE

840	Single Row (3mm tail)
850	Double Row (3mm tail)
790	Single Row (4.5mm tail)
770	Double Row (4.5mm tail)

FINISH

42	Gold + Tin
45	Gold

TOTAL NO. OF CONTACTS

02 to 07, 17, 22	Single Row
04, 06, 08, 10, 12, 14, 16, 18, 20, 26, 34, 44	Double Row

All dimensions in mm.

Datamate L-Tek Connectors

Female Vertical Surface Mount

- ❖ Optional pick and place cap.
- ❖ Gull wing SMT tails simplify inspection process.

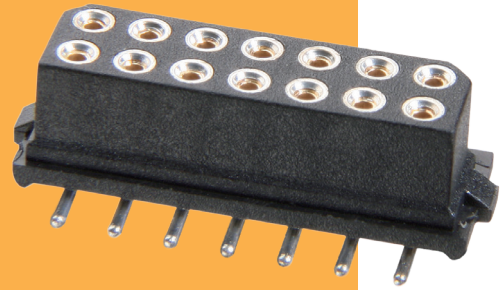

DATAMATE L-TEK

DOUBLE ROW

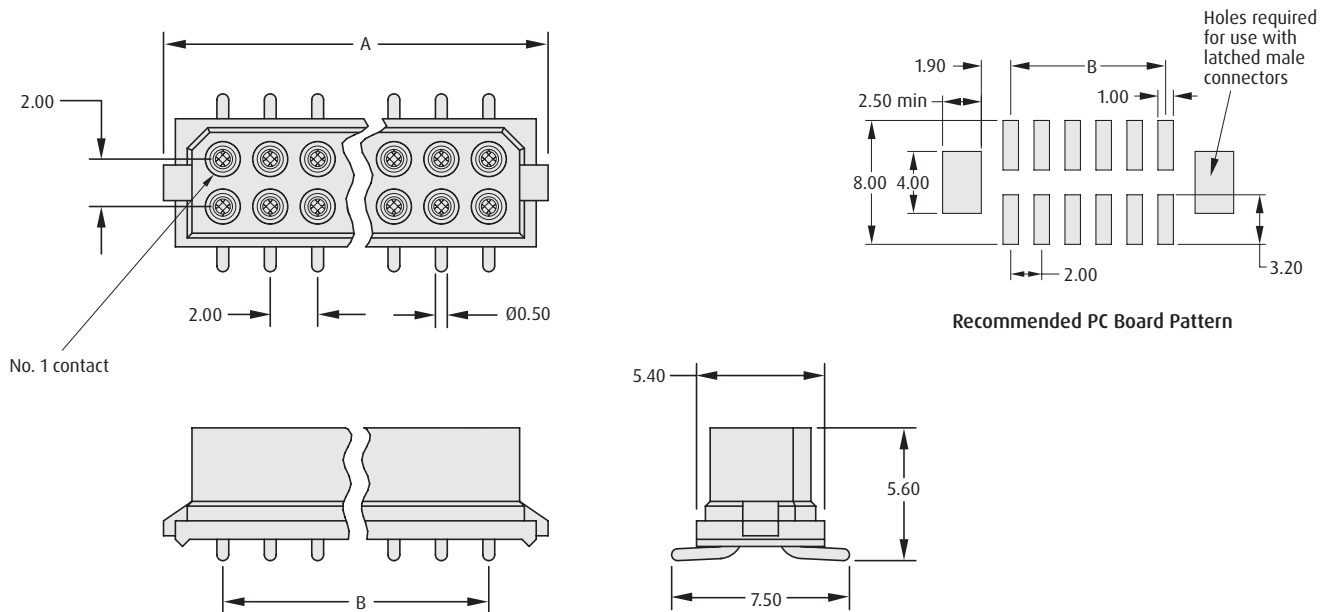

CALCULATION	
A	$B + 5.15$
B	Total no. of contacts - 2

HOW TO ORDER

M80 - 681 XX XX P

SERIES CODE

TOTAL NO. OF CONTACTS
04, 06, 08, 10, 12, 14, 16, 18, 20, 26, 34, 44

PICK AND PLACE CAP	
BLANK	No cap
P	Pick and place cap

FINISH	
42	Gold + Tin
45	Gold

All dimensions in mm.

Datamate L-Tek Connectors

DATAMATE L-TEK

Female Crimp Kit

- Part numbers are for a complete kit of a housing and the applicable number of contacts.
- Contacts are rear insertable.
- Spare contacts are available – see the following page.



SINGLE ROW	CALCULATION	DOUBLE ROW	CALCULATION
	A B + 5.15		A B + 5.15
	B (Total no. of contacts - 1) x 2		B Total no. of contacts - 2

TOOLS	WIRE STRIPPING DETAILS
<p>Recommended Crimp Tool - M22520/2-01</p> <p>Positioner - T5747</p> <p>Contact Insertion/Removal Tool - Z80-280</p> <ul style="list-style-type: none"> Spare and pre-cabled contacts shown on following pages. Instruction sheets available at www.harwin.com/instructions. 	

HOW TO ORDER

M80 - XXX XX XX

SERIES CODE

TYPE	
798	Single Row, Extra Small Bore (28-32 AWG)
898	Single Row, Small Bore (24-28 AWG)
899	Single Row, Large Bore (22 AWG)
788	Double Row, Extra Small Bore (28-32 AWG)
888	Double Row, Small Bore (24-28 AWG)
889	Double Row, Large Bore (22 AWG)

FINISH

01	Gold + Tin
05	Gold

TOTAL NO. OF CONTACTS

02 to 07, 17	Single Row
04, 06, 08, 10, 12, 14, 16, 18, 20, 26, 34	Double Row

All dimensions in mm.

Datamate L-Tek Connectors

Spare Female Crimp Contacts

- Barrel Crimp Contacts are supplied with the connectors - see previous page. Use the order code for extra spare crimps.



CRIMP CONTACTS	DUMMY CONTACT														
<p>Large Bore (22 AWG)</p> <p>Small Bore (24 to 28 AWG)</p> <p>Extra Small Bore (28 to 32 AWG)</p>	<div style="border: 1px solid black; padding: 2px; width: fit-content; margin-top: 5px;"> ORDER CODE M80-023 </div>														
	WIRE STRIPPING DETAILS														
	TOOLS														
	<p>Recommended Crimp Tool - M22520/2-01 Positioner - T5747 Contact Insertion/Removal Tool - Z80-280</p> <ul style="list-style-type: none"> Pre-cabled contacts shown on following page. Instruction sheets available at www.harwin.com/instructions. 														
HOW TO ORDER															
	M80 - 0XX 00 XX														
<div style="border: 1px solid black; padding: 5px; margin-bottom: 10px;"> SERIES CODE </div> <table border="1" style="width: 100%; border-collapse: collapse;"> <thead> <tr> <th colspan="2" style="background-color: #f4a460;">TYPE</th> </tr> </thead> <tbody> <tr> <td style="text-align: center; font-weight: bold;">011</td> <td>Large Bore (22 AWG)</td> </tr> <tr> <td style="text-align: center; font-weight: bold;">013</td> <td>Small Bore (24-28 AWG)</td> </tr> <tr> <td style="text-align: center; font-weight: bold;">019</td> <td>Extra Small Bore (28-32 AWG)</td> </tr> </tbody> </table>	TYPE		011	Large Bore (22 AWG)	013	Small Bore (24-28 AWG)	019	Extra Small Bore (28-32 AWG)	<table border="1" style="width: 100%; border-collapse: collapse;"> <thead> <tr> <th colspan="2" style="background-color: #f4a460;">FINISH</th> </tr> </thead> <tbody> <tr> <td style="text-align: center; font-weight: bold;">01</td> <td>Gold + Tin</td> </tr> <tr> <td style="text-align: center; font-weight: bold;">05</td> <td>Gold</td> </tr> </tbody> </table>	FINISH		01	Gold + Tin	05	Gold
TYPE															
011	Large Bore (22 AWG)														
013	Small Bore (24-28 AWG)														
019	Extra Small Bore (28-32 AWG)														
FINISH															
01	Gold + Tin														
05	Gold														

All dimensions in mm.

Datamate L-Tek Connectors

Female Crimp Contacts – Pre-Crimped Wires

- Female crimp contacts pre-assembled with a choice of BS 3G 210 Type A cable at selected lengths.
- PTFE-insulated, multi-strand silver-plated copper conductor equipment wire.
- Ideal for prototype and pre-production applications.

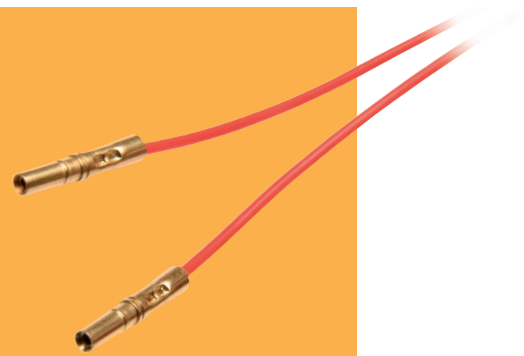

DATAMATE L-TEK

FEMALE SINGLE ENDED	FEMALE - FEMALE

TOOLS

Contact Insertion/Removal Tool – Z80-280

- Full crimp connector kits and spare crimp contacts shown on previous pages.
- Instruction sheets available at www.harwin.com/instructions.

HOW TO ORDER

M80 - 9XX 00 99

SERIES CODE

CABLE COLOR

99 Red

SINGLE ENDED	FEMALE-FEMALE	
910	918	22 AWG Cable, 150mm length
911	919	24 AWG Cable, 150mm length
912	920	26 AWG Cable, 150mm length
913	921	28 AWG Cable, 150mm length
914	922	22 AWG Cable, 300mm length
915	923	24 AWG Cable, 300mm length
916	924	26 AWG Cable, 300mm length
917	925	28 AWG Cable, 300mm length

All dimensions in mm.

Datamate L-Tek Connectors

Female Cable Assemblies

- Ready-made cable assemblies, fully tested and inspected.
- Constructed with Contact 1 to Contact 1, Contact 2 to Contact 2, etc.
- Double Row connectors (10 contacts and larger) compatible with plastic Hood shown on following page.
- For multicolor sequence, check applicable Technical Drawing.

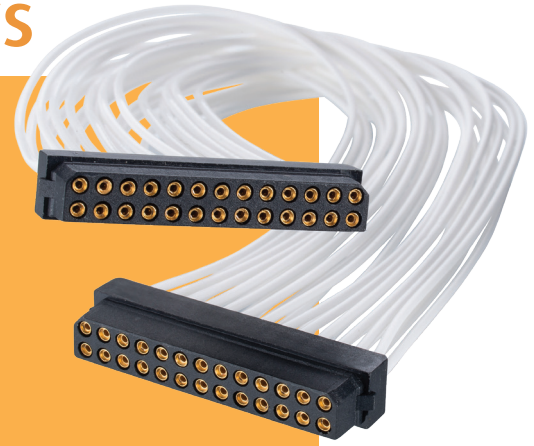

DATAMATE L-TEK

SINGLE ROW, SINGLE ENDED	DOUBLE ROW, SINGLE ENDED																																										
FEMALE - FEMALE DOUBLE ENDED																																											
HOW TO ORDER																																											
M80 - FX X XX XX L0 - XXXX X																																											
<table border="1" style="width: 100%; border-collapse: collapse;"> <thead> <tr style="background-color: #f4a460; color: white;"> <th colspan="2">SERIES CODE</th> </tr> </thead> <tbody> <tr> <td style="width: 30%;">M80-FD</td> <td>Single Row</td> </tr> <tr> <td>M80-FC</td> <td>Double Row</td> </tr> </tbody> </table> <table border="1" style="width: 100%; border-collapse: collapse;"> <thead> <tr style="background-color: #f4a460; color: white;"> <th colspan="2">CABLE SIZE</th> </tr> </thead> <tbody> <tr> <td style="width: 30%;">1</td> <td>22 AWG</td> </tr> <tr> <td>2</td> <td>24 AWG</td> </tr> <tr> <td>3</td> <td>26 AWG</td> </tr> <tr> <td>4</td> <td>28 AWG</td> </tr> <tr> <td>5</td> <td>30 AWG</td> </tr> </tbody> </table> <table border="1" style="width: 100%; border-collapse: collapse;"> <thead> <tr style="background-color: #f4a460; color: white;"> <th colspan="2">TOTAL NO. OF CONTACTS</th> </tr> </thead> <tbody> <tr> <td style="width: 30%;">02 to 07, 17</td> <td>Single Row</td> </tr> <tr> <td>04, 06, 08, 10, 12, 14, 16, 18, 20, 26, 34</td> <td>Double Row</td> </tr> </tbody> </table>	SERIES CODE		M80-FD	Single Row	M80-FC	Double Row	CABLE SIZE		1	22 AWG	2	24 AWG	3	26 AWG	4	28 AWG	5	30 AWG	TOTAL NO. OF CONTACTS		02 to 07, 17	Single Row	04, 06, 08, 10, 12, 14, 16, 18, 20, 26, 34	Double Row	<table border="1" style="width: 100%; border-collapse: collapse;"> <thead> <tr style="background-color: #f4a460; color: white;"> <th colspan="2">TERMINATION - SECOND END</th> </tr> </thead> <tbody> <tr> <td style="width: 30%;">L</td> <td>Loose cut end</td> </tr> <tr> <td>F</td> <td>Female connector</td> </tr> </tbody> </table> <table border="1" style="width: 100%; border-collapse: collapse;"> <thead> <tr style="background-color: #f4a460; color: white;"> <th colspan="2">CABLE LENGTH</th> </tr> </thead> <tbody> <tr> <td style="width: 30%;">0150</td> <td>150mm</td> </tr> <tr> <td>XXXX</td> <td>XXXXmm</td> </tr> </tbody> </table> <table border="1" style="width: 100%; border-collapse: collapse;"> <thead> <tr style="background-color: #f4a460; color: white;"> <th colspan="2">WIRE COLOR</th> </tr> </thead> <tbody> <tr> <td style="width: 30%;">05</td> <td>White cable (double-ended)</td> </tr> <tr> <td>68</td> <td>Multicolor cable (single-ended)</td> </tr> </tbody> </table>	TERMINATION - SECOND END		L	Loose cut end	F	Female connector	CABLE LENGTH		0150	150mm	XXXX	XXXXmm	WIRE COLOR		05	White cable (double-ended)	68	Multicolor cable (single-ended)
SERIES CODE																																											
M80-FD	Single Row																																										
M80-FC	Double Row																																										
CABLE SIZE																																											
1	22 AWG																																										
2	24 AWG																																										
3	26 AWG																																										
4	28 AWG																																										
5	30 AWG																																										
TOTAL NO. OF CONTACTS																																											
02 to 07, 17	Single Row																																										
04, 06, 08, 10, 12, 14, 16, 18, 20, 26, 34	Double Row																																										
TERMINATION - SECOND END																																											
L	Loose cut end																																										
F	Female connector																																										
CABLE LENGTH																																											
0150	150mm																																										
XXXX	XXXXmm																																										
WIRE COLOR																																											
05	White cable (double-ended)																																										
68	Multicolor cable (single-ended)																																										

All dimensions in mm.

Datamate L-Tek Connectors

Female Plastic Cable Hood

- ❖ Supplied as a kit of parts, including body, lid, cable clamp and 4 screws.
- ❖ For use with double row female crimp connectors.
- ❖ Mates with unlatched male connectors.



DATAMATE L-TEK

CRIMP HOOD

CALCULATION

A	$B + 8.3$
B	Total no. of contacts - 2
C	$B + 6.3$

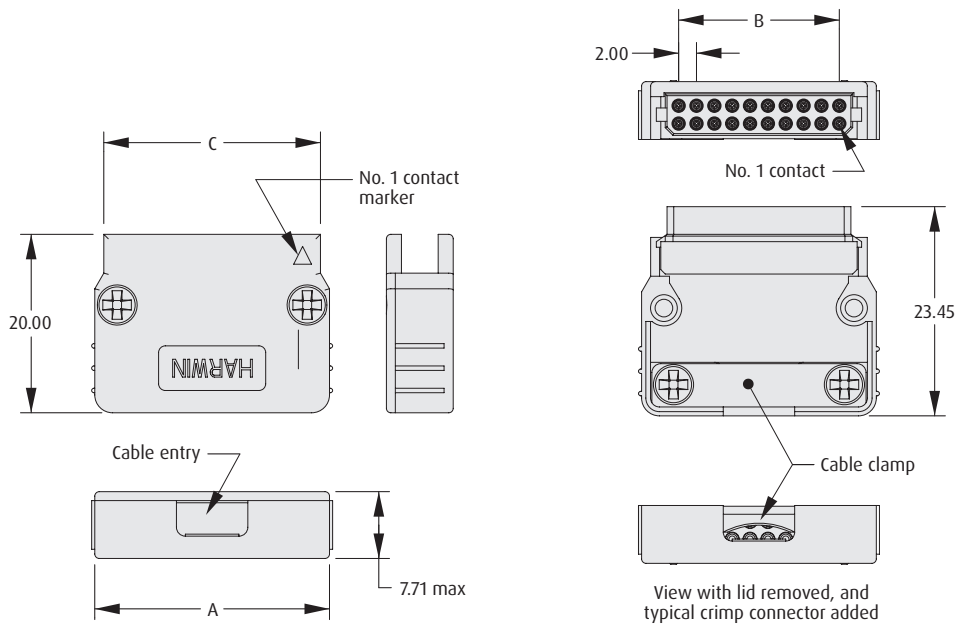

HOW TO ORDER

M80 - 880 XX 98

SERIES CODE

TOTAL NO. OF CONTACTS

10, 12, 14, 16, 18, 20, 26, 34

All dimensions in mm.

Datamate L-Tek Connectors

DATAMATE L-TEK

Male Single Row Vertical Throughboard

- Polarized housings.
- Fully shrouded contacts.
- Mates with standard Datamate L-Tek female connectors.
- Can be used with optional Strain Relief straps, available to order separately: **order code M80-0030006**.

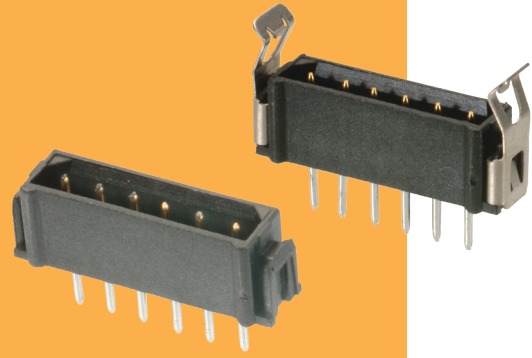

NO LATCHES	CALCULATION	LOCKING LATCH	CALCULATION
	A B + 5.6		A B + 6.1
	B (Total no. of contacts - 1) x 2		B (Total no. of contacts - 1) x 2

STRAIN RELIEF STRAP

Order separately from connector

View of Strain Relief strap in place

Recommended PC Board Pattern

4 x Ø0.90 min (optional) for Strain Relief Straps

ORDER CODE
M80-0030006

HOW TO ORDER

M80 - XXX XX XX

SERIES CODE		FINISH
TYPE		42 Gold + Tin
852 No Latches, 3mm Tail		45 Gold
882 Locking Latch, 3mm Tail		
782 Locking Latch, 4.5mm Tail		
		TOTAL NO. OF CONTACTS
		02 to 07

All dimensions in mm.

Datamate L-Tek Connectors

Male Double Row Vertical Throughboard

- ❖ Polarized housings.
- ❖ Fully shrouded contacts.
- ❖ Mates with standard Datamate L-Tek female connectors.
- ❖ Can be used with optional Strain Relief straps, available to order separately: **order code M80-0030006**.

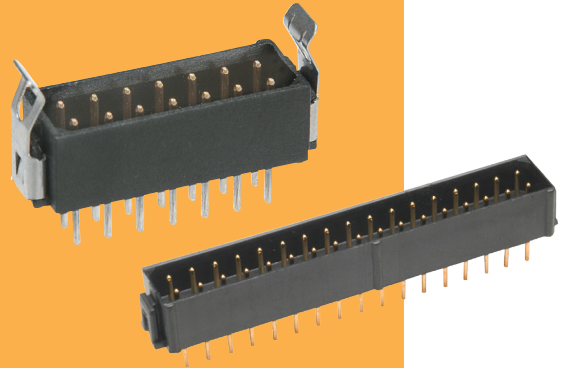

DATAMATE L-TEK

NO LATCHES	CALCULATION	LOCKING LATCH	CALCULATION
	A B + 5.6		A B + 6.1
	B Total no. of contacts - 2		B Total no. of contacts - 2

STRAIN RELIEF STRAP

Order separately from connector

View of Strain Relief strap in place

Recommended PC Board Pattern

ORDER CODE

M80-0030006

HOW TO ORDER

SERIES CODE

3mm TAIL	4.5mm TAIL	
854	754	No Latches
853	753	Locking Latch

M80 - XXX XX XX

FINISH

42	Gold + Tin
45	Gold

TOTAL NO. OF CONTACTS

04, 06, 08, 10, 12, 14, 16, 18, 20, 26, 34, 44

All dimensions in mm.

Datamate L-Tek Connectors

DATAMATE L-TEK

Male Single Row Horizontal Throughboard

- Polarized housings.
- Fully shrouded contacts.
- Mates with standard Datamate L-Tek female connectors.
- Supplied with two Strain Relief straps per connector; spares available under **order code M80-0030006**.

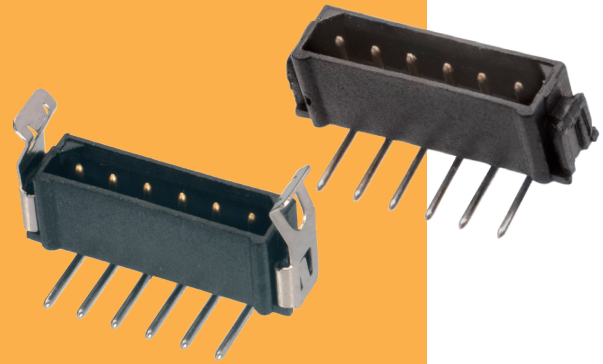

NO LATCHES	CALCULATION	LOCKING LATCH	CALCULATION
	A B + 5.6		A B + 6.1
	B (Total no. of contacts - 1) x 2		B (Total no. of contacts - 1) x 2

STRAIN RELIEF STRAP	Supplied with connector	Recommended PC Board Pattern
	<p>View of Strain Relief strap in place</p>	

HOW TO ORDER

M80 - XXX XX XX

SERIES CODE		FINISH	
TYPE		42	Gold + Tin
843	No Latches, 3mm Tail	45	Gold
842	Locking Latch, 3mm Tail	TOTAL NO. OF CONTACTS	
792	Locking Latch, 4.5mm Tail	02 to 07	

All dimensions in mm.

Datamate L-Tek Connectors

Male Double Row Horizontal Throughboard

- ❖ Polarized housings.
- ❖ Fully shrouded contacts.
- ❖ Mates with standard Datamate L-Tek female connectors.
- ❖ Supplied with two Strain Relief straps per connector; spares available under **order code M80-0030006**.

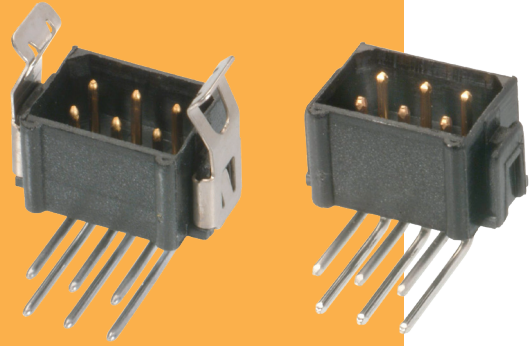

DATAMATE L-TEK

NO LATCHES	CALCULATION	LOCKING LATCH	CALCULATION
	A B + 5.6		A B + 6.1
	B Total no. of contacts - 2		B Total no. of contacts - 2

STRAIN RELIEF STRAP	Supplied with connector	Recommended PC Board Pattern
	<p>View of Strain Relief strap in place</p>	

HOW TO ORDER

M80 - XXX XX XX

SERIES CODE

TYPE

841	No Latches, 3mm Tail
851	Locking Latch, 3mm Tail
771	Locking Latch, 4.5mm Tail

FINISH

42	Gold + Tin
45	Gold

TOTAL NO. OF CONTACTS

04, 06, 08, 10, 12, 14, 16, 18, 20, 26, 34, 44

All dimensions in mm.

Datamate L-Tek Connectors

Male Vertical Surface Mount

- Mates with standard Datamate L-Tek female connectors.
- Can be used with optional Strain Relief straps, available to order separately: **order code M80-0030006**.
- Optional pick and place cap.
- Gull wing SMT tails simplify inspection process.

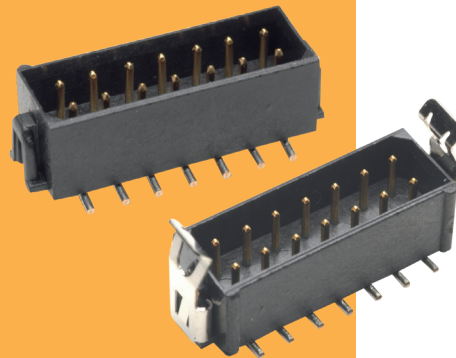

DATAMATE L-TEK

NO LATCHES	CALCULATION	LOCKING LATCH	CALCULATION
	A B + 5.6		A B + 6.1
	B Total no. of contacts - 2		B Total no. of contacts - 2

STRAIN RELIEF STRAP Order separately from connector

View of Strain Relief strap in place

ORDER CODE
M80-0030006

Recommended PC Board Pattern

HOW TO ORDER

M80 - 82X XX XX P

SERIES CODE		PICK AND PLACE CAP	
TYPE		BLANK	No cap
826	No Latches	P	Pick and place cap
828	Locking Latch		
	TOTAL NO. OF CONTACTS	FINISH	
	04, 06, 08, 10, 12, 14, 16, 18, 20, 26, 34	42	Gold + Tin
		45	Gold

All dimensions in mm.

Datamate L-Tek Connectors

Male Horizontal Surface Mount

- ❖ Mates with standard Datamate L-Tek female connectors.
- ❖ Supplied with two Strain Relief straps per connector; spares available under **order code M80-0030006**.
- ❖ Stamped contact ensures co-planarity.

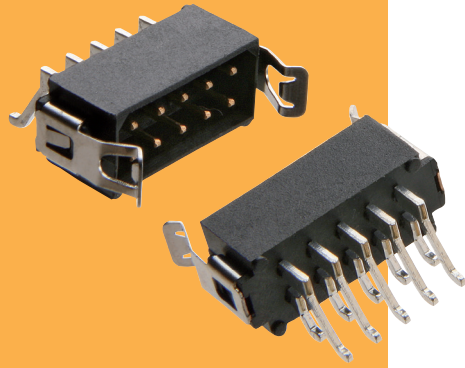

DATAMATE L-TEK

NO LATCHES	CALCULATION	LOCKING LATCH	CALCULATION
	A B + 5.6		A B + 6.1
	B Total no. of contacts - 2		B Total no. of contacts - 2

STRAIN RELIEF STRAP	Supplied with connector	Recommended PC Board Pattern
	<p style="text-align: center;">View of Strain Relief strap in place</p>	

HOW TO ORDER

M80 - 66X XX 42

SERIES CODE		FINISH								
TYPE		42 Gold + Tin								
<table border="1" style="width: 100%; border-collapse: collapse;"> <tr> <td style="width: 10%;">665</td> <td>No Latches</td> </tr> <tr> <td>666</td> <td>Locking Latch</td> </tr> </table>	665	No Latches	666	Locking Latch		<table border="1" style="width: 100%; border-collapse: collapse;"> <tr> <td colspan="2" style="text-align: center;">TOTAL NO. OF CONTACTS</td> </tr> <tr> <td colspan="2" style="text-align: center;">04, 06, 08, 10, 12, 14, 16, 18, 20, 26, 34</td> </tr> </table>	TOTAL NO. OF CONTACTS		04, 06, 08, 10, 12, 14, 16, 18, 20, 26, 34	
665	No Latches									
666	Locking Latch									
TOTAL NO. OF CONTACTS										
04, 06, 08, 10, 12, 14, 16, 18, 20, 26, 34										

All dimensions in mm.

Datamate L-Tek Connectors

Male Crimp Kit

- Part numbers are for a complete kit of a housing and the applicable number of contacts.
- Contacts are rear insertable.
- Spare contacts are available - see the following page.

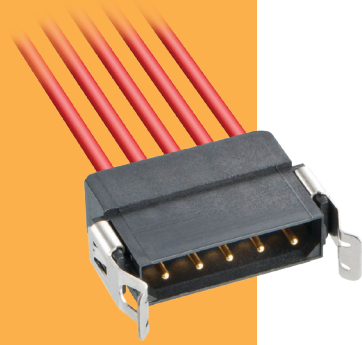

DATAMATE L-TEK

SINGLE ROW	CALCULATION	DOUBLE ROW	CALCULATION
	A B + 5.6		A B + 5.6
	B (Total no. of contacts - 1) x 2		B Total no. of contacts - 2
Latches (when fitted) add 0.5mm to overall length 'A'		Latches (when fitted) add 0.5mm to overall length 'A'	

TOOLS	WIRE STRIPPING DETAILS
<p>Recommended Crimp Tool - M22520/2-01</p> <p>Positioner - T5747</p> <p>Contact Insertion/Removal Tool - Z80-280</p> <ul style="list-style-type: none"> Spare contacts shown on following page. Instruction sheets available at www.harwin.com/instructions. 	

HOW TO ORDER

M80 - 8XX XX 05

SERIES CODE		
SINGLE ROW	DOUBLE ROW	
806	810	Small Bore (24-28 AWG), No Latches
807	811	Large Bore (22 AWG), No Latches
808	812	Small Bore (24-28 AWG), Locking Latch
809	813	Large Bore (22 AWG), Locking Latch

FINISH	
05	Gold

TOTAL NO. OF CONTACTS	
02, 03, 04, 05, 06, 07	Single Row
04, 06, 08, 10, 12	Double Row

All dimensions in mm.

Datamate L-Tek Connectors

Spare Male Crimp Contacts

- Barrel Crimp Contacts are supplied with the connectors - see previous page. Use the order code for extra Spare crimps.

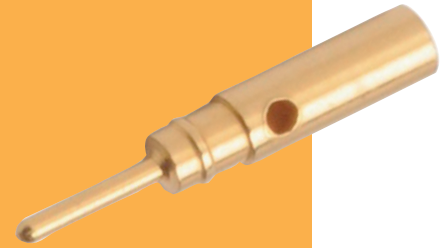

DATAMATE L-TEK

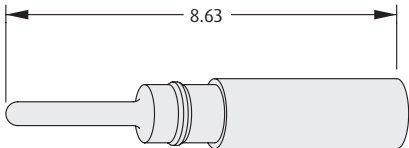
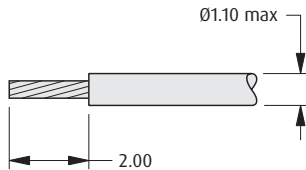
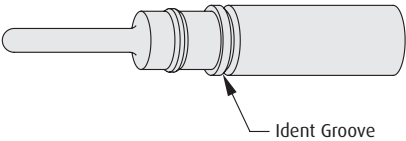
CRIMP CONTACTS	WIRE STRIPPING DETAILS										
<p>Large Bore (22 AWG)</p> 											
<p>Small Bore (24 to 28 AWG)</p> 	<p>TOOLS</p> <p>Recommended Crimp Tool - M22520/2-01 Positioner - T5747 Contact Insertion/Removal Tool - Z80-280</p> <p>❖ Instruction sheets available at www.harwin.com/instructions.</p>										
HOW TO ORDER											
<p style="text-align: center;">M80 - 04X 00 05</p> <div style="display: flex; justify-content: space-between; align-items: flex-start;"> <div data-bbox="147 1598 310 1633" style="border: 1px solid black; padding: 2px;"> <p>SERIES CODE</p> </div> <div data-bbox="147 1675 472 1787" style="border: 1px solid black; padding: 2px;"> <table> <thead> <tr> <th colspan="2">TYPE</th> </tr> </thead> <tbody> <tr> <td>040</td> <td>Large Bore (22 AWG)</td> </tr> <tr> <td>041</td> <td>Small Bore (24-28 AWG)</td> </tr> </tbody> </table> </div> <div data-bbox="1317 1654 1471 1730" style="border: 1px solid black; padding: 2px;"> <table> <thead> <tr> <th colspan="2">FINISH</th> </tr> </thead> <tbody> <tr> <td>05</td> <td>Gold</td> </tr> </tbody> </table> </div> </div>		TYPE		040	Large Bore (22 AWG)	041	Small Bore (24-28 AWG)	FINISH		05	Gold
TYPE											
040	Large Bore (22 AWG)										
041	Small Bore (24-28 AWG)										
FINISH											
05	Gold										

All dimensions in mm.

Datamate Tooling

- ❖ Instruction sheets can be accessed at www.harwin.com/instructions.
- ❖ A Datamate Crimping Instruction video is available at www.harwin.com/harwintv.

HAND CRIMP TOOL	HAND CRIMP TOOL																
<ul style="list-style-type: none"> ❖ Standard circular crimp tool BS5210-3A-300 and MIL specification M22520/2-01. ❖ Precision tool with ratchet mechanism and 8-indent form. ❖ Must be used with applicable positioner shown below. ❖ Instruction sheet available.  <table border="1" data-bbox="414 1024 808 1102"> <thead> <tr> <th colspan="2">ORDER CODE</th> </tr> </thead> <tbody> <tr> <td>Signal contacts</td> <td>M22520/2-01</td> </tr> </tbody> </table>	ORDER CODE		Signal contacts	M22520/2-01	<ul style="list-style-type: none"> ❖ Standard circular crimp tools. ❖ Precision tool with ratchet mechanism and 8-indent form. ❖ Must be used with applicable positioner shown below. ❖ Instruction sheets available.  <table border="1" data-bbox="1088 987 1511 1102"> <thead> <tr> <th colspan="2">ORDER CODE</th> </tr> </thead> <tbody> <tr> <td>Inner contact of Coax contacts</td> <td>Z80-292</td> </tr> <tr> <td>Power crimp contacts</td> <td>Z80-294</td> </tr> </tbody> </table>	ORDER CODE		Inner contact of Coax contacts	Z80-292	Power crimp contacts	Z80-294						
ORDER CODE																	
Signal contacts	M22520/2-01																
ORDER CODE																	
Inner contact of Coax contacts	Z80-292																
Power crimp contacts	Z80-294																
HAND CRIMP TOOL	POSITIONER																
<ul style="list-style-type: none"> ❖ Standard coax crimp tool for crimping the outer sleeve of Mix-Tek coax contacts. ❖ Instruction sheet available.  <table border="1" data-bbox="414 1806 808 1890"> <thead> <tr> <th colspan="2">ORDER CODE</th> </tr> </thead> <tbody> <tr> <td>Outer sleeve of Coax contacts</td> <td>Z80-293</td> </tr> </tbody> </table>	ORDER CODE		Outer sleeve of Coax contacts	Z80-293	<ul style="list-style-type: none"> ❖ Used with applicable hand crimp tool.  <table border="1" data-bbox="998 1659 1511 1890"> <thead> <tr> <th colspan="2">ORDER CODE</th> </tr> </thead> <tbody> <tr> <td>Signal contacts: Male L-Tek, all Female</td> <td>T5747</td> </tr> <tr> <td>Signal contacts: Male J-Tek, Mix-Tek</td> <td>Z80-193</td> </tr> <tr> <td>Inner contact of Coax contacts</td> <td>Z80-291</td> </tr> <tr> <td>Female T-Contact</td> <td>Z80-444</td> </tr> <tr> <td>Power crimp contacts</td> <td>Z80-295</td> </tr> </tbody> </table>	ORDER CODE		Signal contacts: Male L-Tek, all Female	T5747	Signal contacts: Male J-Tek, Mix-Tek	Z80-193	Inner contact of Coax contacts	Z80-291	Female T-Contact	Z80-444	Power crimp contacts	Z80-295
ORDER CODE																	
Outer sleeve of Coax contacts	Z80-293																
ORDER CODE																	
Signal contacts: Male L-Tek, all Female	T5747																
Signal contacts: Male J-Tek, Mix-Tek	Z80-193																
Inner contact of Coax contacts	Z80-291																
Female T-Contact	Z80-444																
Power crimp contacts	Z80-295																

All dimensions in mm.

Datamate Tooling

- ❖ Instruction sheets can be accessed at www.harwin.com/instructions.
- ❖ A Datamate Crimping Instruction video is available at www.harwin.com/harwintv.

INSERTION/REMOVAL TOOL	REMOVAL TOOL																
<ul style="list-style-type: none"> ❖ For inserting crimped contacts into the rear of housings. ❖ Suitable for all Datamate signal Barrel crimp contacts.  <table border="1" style="margin-left: auto; margin-right: auto;"> <thead> <tr> <th colspan="2" style="background-color: #f4a460;">ORDER CODE</th> </tr> </thead> <tbody> <tr> <td style="background-color: #f4a460;">Signal contacts</td> <td style="background-color: #f4a460;">Z80-280</td> </tr> </tbody> </table>	ORDER CODE		Signal contacts	Z80-280	<ul style="list-style-type: none"> ❖ To aid removal of special cable contacts from Mix-Tek connectors.  <table border="1" style="margin-left: auto; margin-right: auto;"> <thead> <tr> <th colspan="2" style="background-color: #f4a460;">ORDER CODE</th> </tr> </thead> <tbody> <tr> <td style="background-color: #f4a460;">Power & Coax cable contacts</td> <td style="background-color: #f4a460;">Z80-290</td> </tr> </tbody> </table>	ORDER CODE		Power & Coax cable contacts	Z80-290								
ORDER CODE																	
Signal contacts	Z80-280																
ORDER CODE																	
Power & Coax cable contacts	Z80-290																
SEPARATOR TOOL	DRIVERS																
<ul style="list-style-type: none"> ❖ Recommended for unplugging L-Tek latched connectors (tool releases the latches prior to disengagement). ❖ Can also be used with unlatched connectors. ❖ Adjustable to suit all housing sizes.  <table border="1" style="margin-left: auto; margin-right: auto;"> <thead> <tr> <th colspan="2" style="background-color: #f4a460;">ORDER CODE</th> </tr> </thead> <tbody> <tr> <td style="background-color: #f4a460;">L-Tek</td> <td style="background-color: #f4a460;">Z80-299</td> </tr> </tbody> </table>	ORDER CODE		L-Tek	Z80-299	<ul style="list-style-type: none"> ❖ Mating jackscrews to be tightened to a torque of 23cmN max. ❖ Board mount nuts and bolts to be tightened to a torque of 21 ±2cmN.  <table border="1" style="margin-left: auto; margin-right: auto;"> <thead> <tr> <th colspan="2" style="background-color: #f4a460;">ORDER CODE</th> </tr> </thead> <tbody> <tr> <td style="background-color: #f4a460;">Slotted Nut Screwdriver (board mount nuts)</td> <td style="background-color: #f4a460;">Z80-298</td> </tr> <tr> <td style="background-color: #f4a460;">1.5mm A/F Hex Drive Bit (board mount bolts)</td> <td style="background-color: #f4a460;">Z9950-00</td> </tr> <tr> <td style="background-color: #f4a460;">2mm A/F Hex Drive Bit (floating jackscrews)</td> <td style="background-color: #f4a460;">Z9951-00</td> </tr> <tr> <td style="background-color: #f4a460;">1.5mm A/F Ball Hex Driver (board mount bolts)</td> <td style="background-color: #f4a460;">Z9952-00</td> </tr> <tr> <td style="background-color: #f4a460;">2mm A/F Ball Hex Driver (floating jackscrews)</td> <td style="background-color: #f4a460;">Z9953-00</td> </tr> </tbody> </table>	ORDER CODE		Slotted Nut Screwdriver (board mount nuts)	Z80-298	1.5mm A/F Hex Drive Bit (board mount bolts)	Z9950-00	2mm A/F Hex Drive Bit (floating jackscrews)	Z9951-00	1.5mm A/F Ball Hex Driver (board mount bolts)	Z9952-00	2mm A/F Ball Hex Driver (floating jackscrews)	Z9953-00
ORDER CODE																	
L-Tek	Z80-299																
ORDER CODE																	
Slotted Nut Screwdriver (board mount nuts)	Z80-298																
1.5mm A/F Hex Drive Bit (board mount bolts)	Z9950-00																
2mm A/F Hex Drive Bit (floating jackscrews)	Z9951-00																
1.5mm A/F Ball Hex Driver (board mount bolts)	Z9952-00																
2mm A/F Ball Hex Driver (floating jackscrews)	Z9953-00																

All dimensions in mm.