



ELECTRONIC TIME RELAYS



RS Stock. No's. :

- 1) 896-6848 Multi-function DPCO
- 2) 896-6850 Multi-function SPCO
- 3) 896-6857 Star-Delta Starter timer

TERMINAL DETAILS :

	0.6 N.m (6 Lb.in) Terminal screw - M3
	1 X 1 ...4 mm ² Solid Wire / Single wire Ferrule
	2 x 0.5 ...2.5 mm ² Insulated Twin Wire Ferrule
AWG	1 X 16 to 12

Use Cu wire of 75° C only.

AWG	CURRENT (A)
12	5.00
14	3.33
16	1.67

The timers shall be placed in an enclosure that is minimum 200% of the size of the timer in the end use application.

Caution :

1. Always follow instructions stated in this product leaflet.
2. Before installation, check that the specifications agree with the intended application.
3. Installation to be done by skilled electrician.
4. Automation and control devices must be installed properly so that they are protected against any risk of involuntary actuations.
5. Suitable dampers should be provided in the event of excessive vibrations.
6. Setting of all the potentiometers should be in clockwise direction only.
7. Do not connect supply between B1 and B2 terminals. For proper signal operation, follow supply polarity as per connection diagram.
8. In 2AJDT0/1, any change at B1-B2 will have no effect once timer starts.
9. Use 250 mA fuse in series with the above mentioned products.
10. In 20NDTT & 20JDTT, use 3 A²s (I²t) fuse externally.
11. In 20NDTT & 20JDTT, Minimum switching operational current is 10 mA.

Product overall dimensions and mounting details :

Note : All dimensions are in 'mm'.

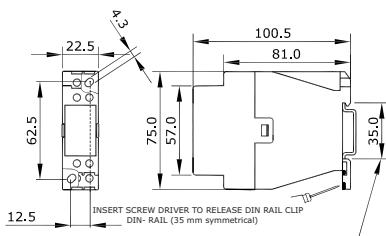

Installation :

- A) Base Mounting : Timer should be mounted on a plain surface using two M4 screws.
- B) DIN - Rail Mounting : The Timer should be mounted on 35 mm symmetrical DIN Rail.

1) MULTI-FUNCTION DPCO Supply voltage start functions: RS Stock No: 896-6848

Timing Diagram:

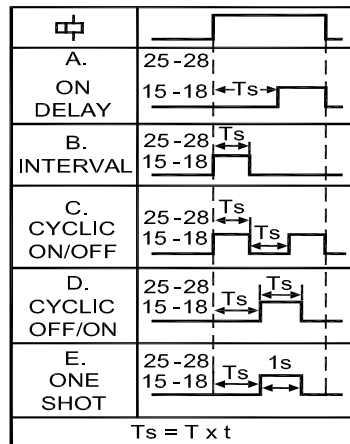

Connection Diagram :

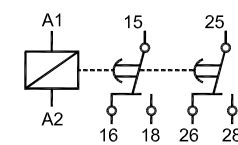

2) MULTI-FUNCTION TIMER SPCO. Signal start functions:

Function Diagrams for 896-6850

A) SIGNAL ON DELAY :

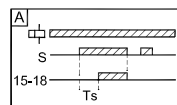

B) ACCUMULATIVE ON DELAY:

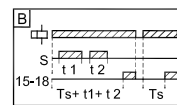

C) SIGNAL OFF DELAY :

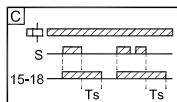

D) SIGNAL OFF / ON DELAY:

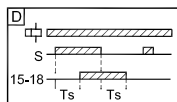

E) LEADING EDGE IMPULSE 1 :

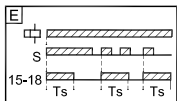

a) ON DELAY :

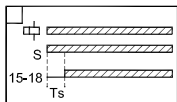

e) INTERVAL :

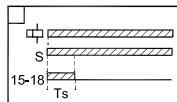

Connection Diagram For 896-6850

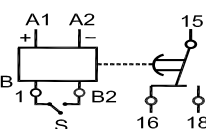

3) STAR - DELTA STARTER: RS Stock No: 896-6857

When the supply is applied, Output Star Relay turns ON. After completion of set Star ON time, Star Relay turns OFF and Delta Relay turns ON after the set Pause Time and remains ON while the Supply is present.

Timing Diagram :

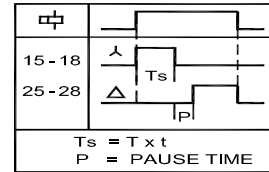

Connection Diagram :

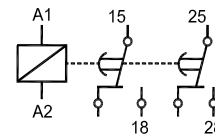

Recommended Star - Delta Control Circuit :

(Below circuit is for STAR - DELTA Timer with 240 VAC Supply.)

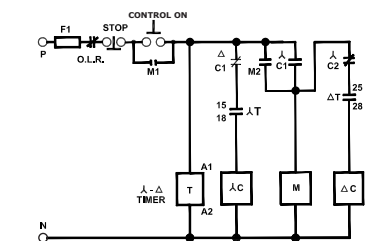

- 1) F1 - Mains Protection Fuse
- 2) O.L.R - Over Load Relay
- 3) M1 - First 'NO' Contact of Main Contact or
- 4) M2 - Second 'NO' Contact of Main Contact or
- 5) M - Main Contact of driving Motor
- 6) lambda C - 'NO' Contact
- 7) lambda C1 - 'NO' Contact of Star Contact or
- 8) lambda C2 - 'NO' Contact of Star Contact or
- 9) lambda C - Delta Contact or
- 10) lambda C1 - 'NC' Contact of Delta Contact or
- 11) lambda T - Star Contact of Timer (lambda-Delta)
- 12) lambda Delta T - Delta Contact of Timer (lambda-Delta)

Application :

For continuous process control, where a Stop resulting from a short, voltage fault could cause Serious problems. If supply interruption is < 0.2 s, then motor can be restarted immediately due to motor inertia properties. If supply interruption is within 0.2 s to 6 s (Tm settable), then relay is made ON after set delay time (Retentive) as motor requires stabilization period. After set memory time Tm, Relay will not START until START button is pressed.