

Automobile Switch

Q-902

TYPE: **ASW-09D**

SPECIFICATIONS

Contact Type: SPST
Rating: 20A 12V DC
Contact R: 50mΩ max
Insulation R: 500V DC 100MΩ min
Dielectric Strength: 1 Minute 1500V AC
Operating Temperature: -25°C ~ +85°C
Electrical Life: 10, 000 Cycles

Outline Drawing

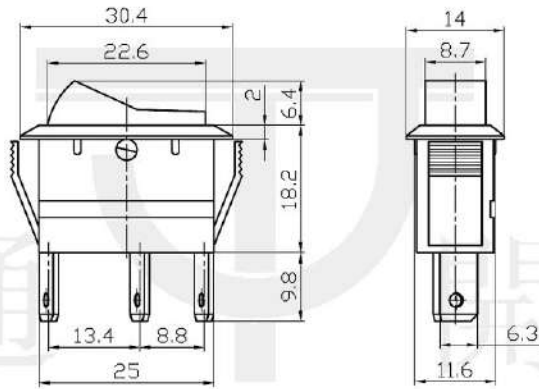

Mounting

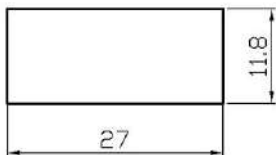

Circuitry

