

170011-2 ✓ ACTIVE

TE Internal #: 170011-2

Ring Terminals & Spade Terminals, Ring Tongue, 18 – 14 AWG

Wire Size, .8 – 2 mm<sup>2</sup> Wire Size, 2050 – 5180 CMA Wire Size, Stud Size #10

[View on TE.com >](#)



Terminals & Splices > Ring Terminals & Spade Terminals

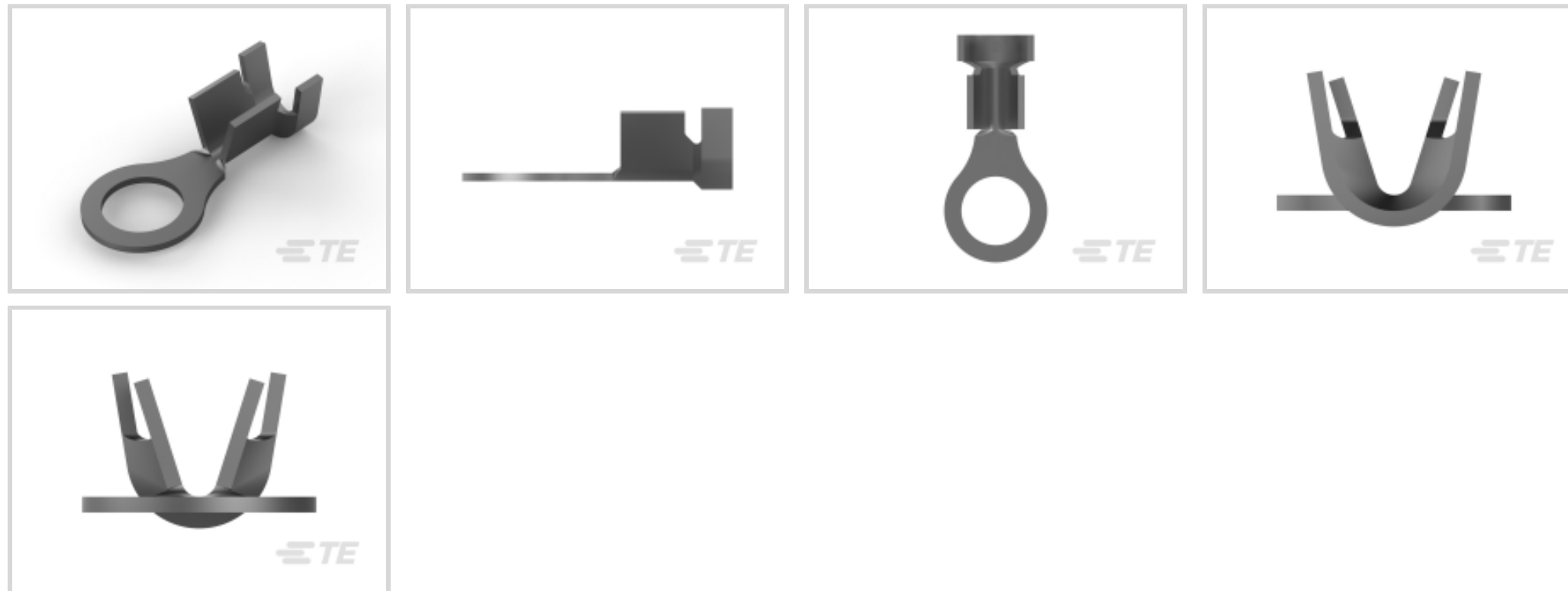

Ring & Spade Terminal Type: **Ring Tongue**

Wire Size: **2050 – 5180 CMA**

Stud Size: **#10**

## Features

### Product Type Features

Shape Description	Circular/Oval
Stud Size	#10
Sealable	No
Compatible With Discrete Wire Type	Stranded
Wire Insulation Support Retention Type	Insulation Support

### Configuration Features

Number of Holes	1
-----------------	---

### Contact Features

Contact Base Material	Brass
Ring & Spade Terminal Type	Ring Tongue
Barrel Type	Open
Terminal Orientation	Straight
Terminal Plating Material	Tin
Contact Underplating Material	None

### Mechanical Attachment

Wire Insulation Support	With
-------------------------	------



### Dimensions

	.122 in
Wire Size	2050 – 5180 CMA
Stud Diameter	5 mm [.197 in]
Tongue Thickness	.51 mm [.02 in]
Product Length	16.76 mm [.66 in]
Barrel Inside Diameter	1.14 mm, 3.68 mm [.045 in] [.144 in]
Compatible Insulation Diameter (Max)	4.29 mm [.169 in]
Compatible Insulation Diameter Range	3.1 – 4.3 mm [.122 – .169 in]

### Usage Conditions

Insulation Option	Uninsulated
Operating Temperature Range	-40 – 110 °C [-40 – 230 °F]

### Operation/Application

Compatible With Wire Base Material	Copper
------------------------------------	--------

### Industry Standards

Government Qualified Terminal	No
-------------------------------	----

### Packaging Features

Packaging Quantity	6000
Packaging Method	Strip/Reel

### Product Compliance







[For compliance documentation, visit the product page on TE.com>](#)

EU RoHS Directive 2011/65/EU	Compliant
EU ELV Directive 2000/53/EC	Compliant
China RoHS 2 Directive MIIT Order No 32, 2016	No Restricted Materials Above Threshold
EU REACH Regulation (EC) No. 1907/2006	Current ECHA Candidate List: JUNE 2023 (235) Candidate List Declared Against: JAN 2023 (233) Does not contain REACH SVHC
Halogen Content	Low Halogen - Br, Cl, F, I < 900 ppm per homogenous material. Also BFR/CFR/PVC Free
Solder Process Capability	Not applicable for solder process capability

Product Compliance Disclaimer

This information is provided based on reasonable inquiry of our suppliers and represents our current actual knowledge based on the information they provided. This information is subject to change. The part numbers that TE has identified as EU RoHS compliant have a maximum concentration of 0.1% by weight in homogenous materials for lead, hexavalent chromium, mercury, PBB, PBDE, DBP, BBP, DEHP, DIBP, and 0.01% for cadmium, or qualify for an exemption to these limits as defined in the Annexes of Directive 2011/65/EU (RoHS2). Finished electrical and electronic equipment products will be CE marked as required by Directive 2011/65/EU. Components may not be CE marked. Additionally, the part numbers that TE has identified as EU ELV compliant have a maximum concentration of 0.1% by weight in homogenous materials for lead, hexavalent chromium, and mercury, and 0.01% for cadmium, or qualify for an exemption to these limits as defined in the Annexes of Directive 2000/53/EC (ELV). Regarding the REACH Regulation, the information TE provides on SVHC in articles for this part number is based on the latest European Chemicals Agency (ECHA) 'Guidance on requirements for substances in articles' posted at this URL: <https://echa.europa.eu/guidance-documents/guidance-on-reach>

### Compatible Parts

 <p>TE Part # 170011-8 RING STRIP 18-14 MM2 0.503 X 11.938 TPBR</p>	 <p>TE Part # 41333 RING 18-14 AWG TPBR</p>	 <p>TE Part # 155406-5 TONGUE,RING OPEN BARREL 18-14 AWG BR</p>	 <p>TE Part # 440456-1 RING TERMINAL, TPBR</p>
 <p>TE Part # 190225-2 RING I/S PRE TIN BRASS</p>	 <p>TE Part # 170011-1 RING STRIP 18-14 MM2 0.503 X 11.938 BR</p>	 <p>TE Part # 170011-3 RING TERMINAL STRIP .165DIA BR</p>	

### Customers Also Bought

 <p>TE Part #179938-1 AMP POWER DBL LOCK PLUG HSG 3P</p>	 <p>TE Part #170011-8 RING STRIP 18-14 MM2 0.503 X 11.938 TPBR</p>	 <p>TE Part #170037-2 187 FASTON,REC.,20-16 AWG,TPBR</p>	 <p>TE Part #316292-1 3.2 CLUSTER REC L-TYPE</p>
---	--	---	---

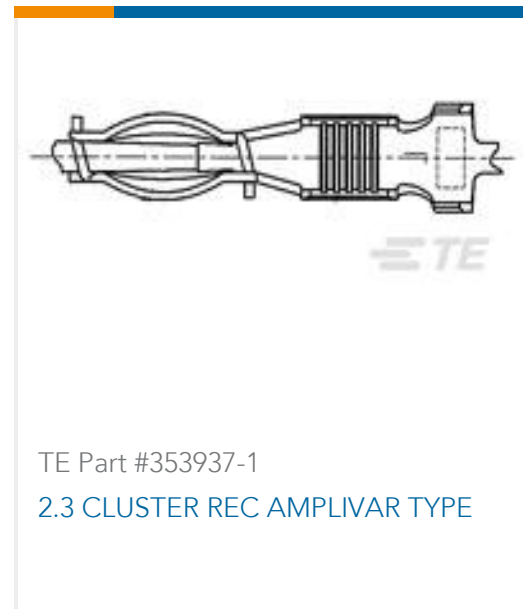
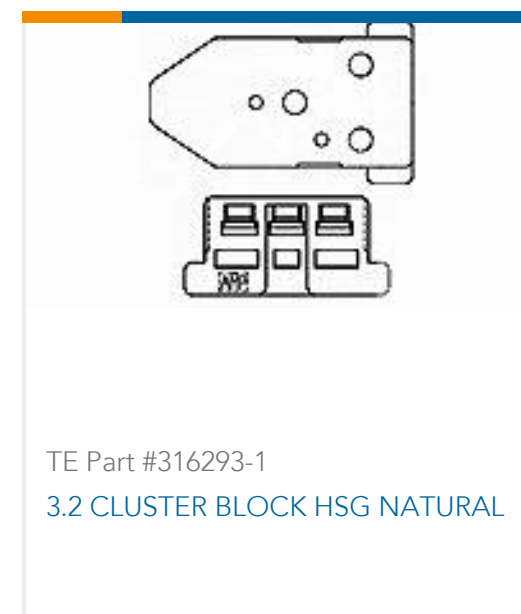
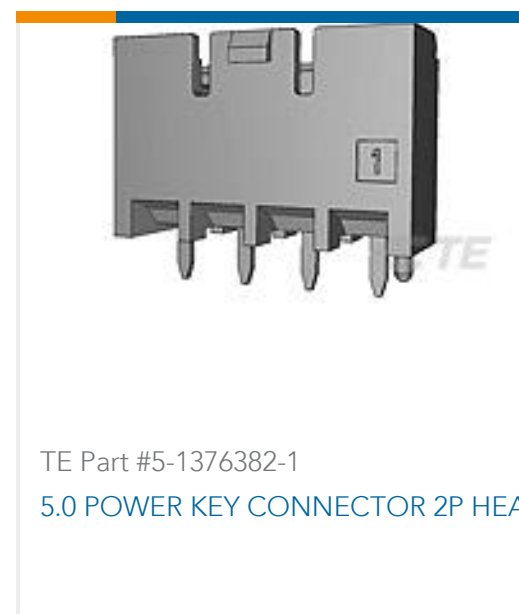
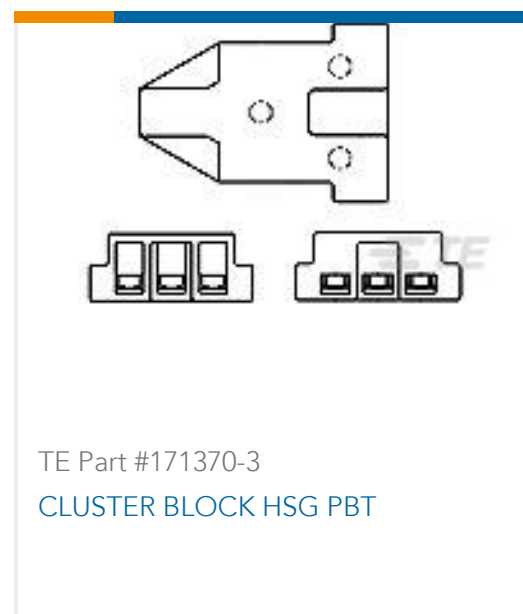

## Documents

### Product Drawings

[RING STRIP 18-14 MM2 0.503 X 11.938 TPBR](#)

English

### CAD Files

[3D PDF](#)

3D

Customer View Model

[ENG\\_CVM\\_CVM\\_170011-2\\_R.2d\\_dxf.zip](#)

English

Customer View Model

[ENG\\_CVM\\_CVM\\_170011-2\\_R.3d\\_igs.zip](#)

English

Customer View Model

[ENG\\_CVM\\_CVM\\_170011-2\\_R.3d\\_stp.zip](#)

English

By downloading the CAD file I accept and agree to the [Terms and Conditions](#) of use.

### Product Specifications

[Application Specification](#)

English

### Product Environmental Compliance

[MD\\_170011-2\\_06212018539\\_dmtec](#)

English

[MD\\_170011-2\\_06212018539\\_dmtec](#)

English



[Agency Approvals](#)

[Agency Approval Document](#)

English