

Single-pole Illuminated Rocker Switch

Q-2594

TYPE: **IRS-101-1C**

SPECIFICATIONS

Contact Type: SPST
Rating: 15A 250V AC
Contact R: 35mΩ max
Insulation R: 500V DC 100MΩ min
Dielectric Strength: 1 Minute 1500V AC
Operating Temperature: -25°C ~ +85°C
Electrical Life: 10, 000 Cycles

Outline Drawing

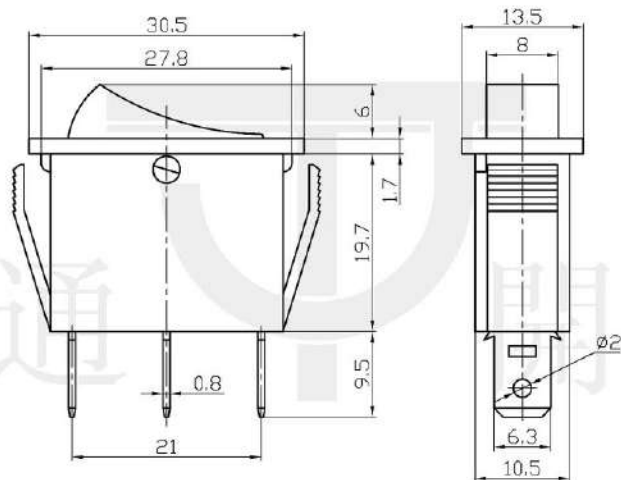

Mounting

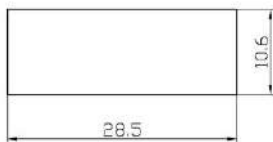

Circuitry

