

REVISIONS					
P	LTR	DESCRIPTION	DATE	DWN	APVD
	10	INITIAL RELEASE	11FEB2020	GK	AK

NOTES: -

1. CHARACTERS: -

0-9, A-Z, +, -, /, ~, ≡

0, 1, 6 & 9 FOLLOWED BY A FULL STOP.

HEIGHT 2.6 - 2.9 mm

TOLERANCE (AXIAL) ±0.75

(ROTATIONAL) ±5°

CHEVRON CUT MARKERS: -

CHARACTERS TO BE CENTRALLY DISPOSED ON MARKER FACE AND IN THE ATTITUDE SHOWN RELATIVE TO CHEVRON.

2. MARKER LENGTHS (DIMENSION 'A'):-

WITH SINGLE MARK 4.00-4.75

WITH DOUBLE MARK 6.75-7.25

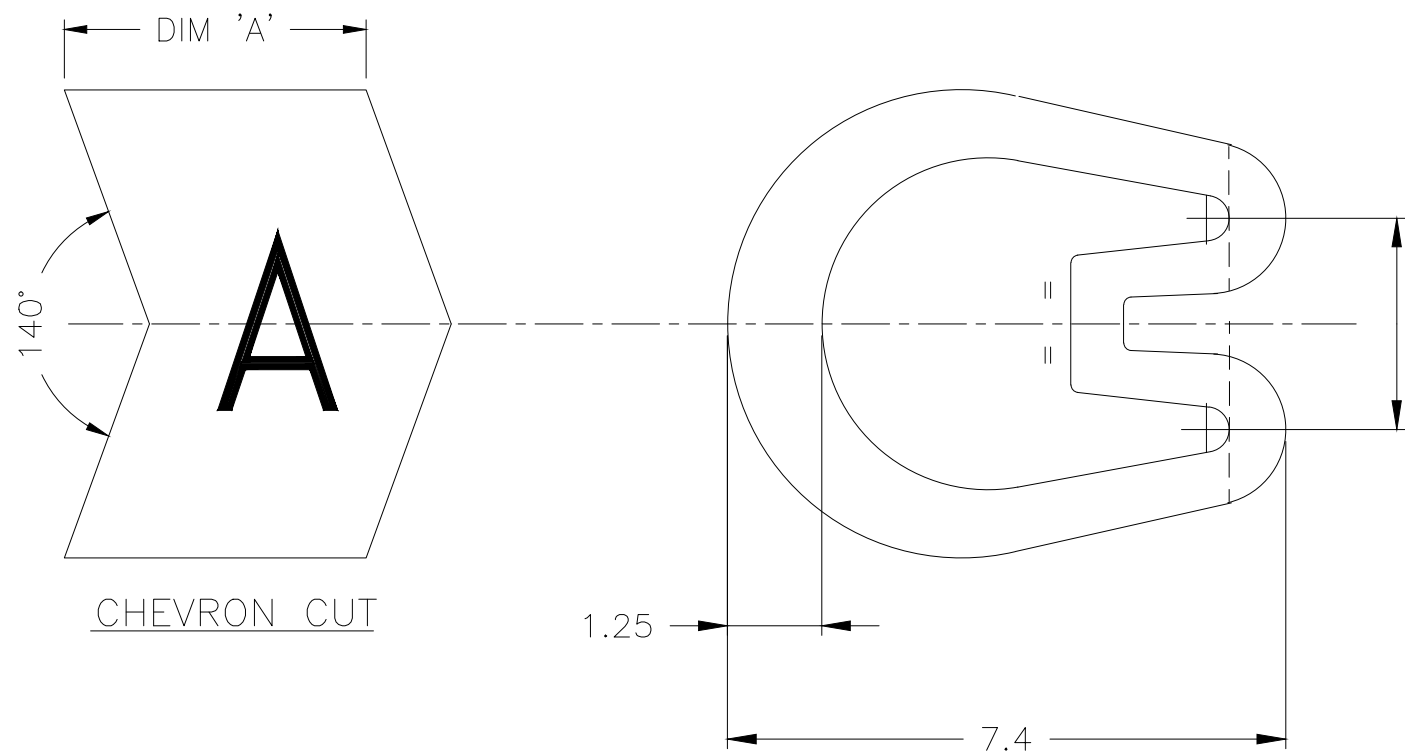

CHEVRON CUT

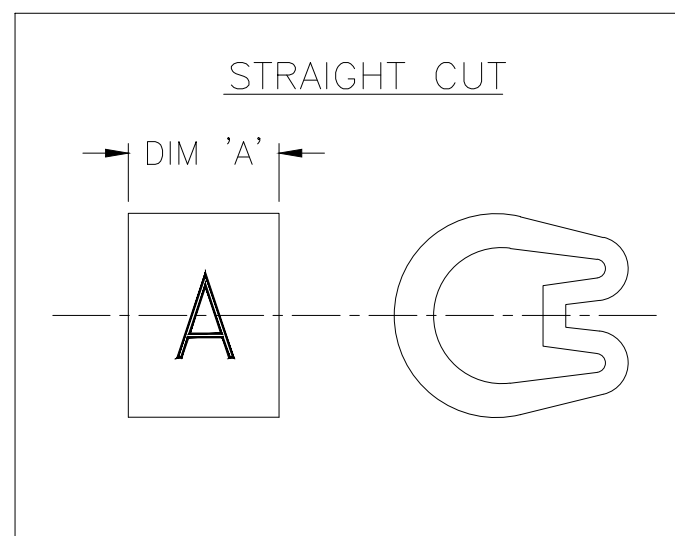

STRAIGHT CUT

THIS DRAWING IS A CONTROLLED DOCUMENT.		DWN GOPALAKRISHNA H V 11FEB2020	STE TE Connectivity															
		CHK ALAN KEAN 11FEB2020																
DIMENSIONS: mm		APVD ALAN KEAN 11FEB2020	NAME MARKER Z TYPE SIZE 18 STRAIGHT / CHEVRON CUT															
TOLERANCES UNLESS OTHERWISE SPECIFIED:		PRODUCT SPEC -	APPLICATION SPEC -															
<table border="0"> <tr><td>0 PLC</td><td>± -</td></tr> <tr><td>1 PLC</td><td>± 0.2</td></tr> <tr><td>2 PLC</td><td>± -</td></tr> <tr><td>3 PLC</td><td>± -</td></tr> <tr><td>4 PLC</td><td>± -</td></tr> <tr><td>ANGLES</td><td>± -</td></tr> </table>		0 PLC	± -	1 PLC	± 0.2	2 PLC	± -	3 PLC	± -	4 PLC	± -	ANGLES	± -	WEIGHT -	SIZE A3	CAGE CODE 00779	DRAWING NO C-1601A0007	RESTRICTED TO -
0 PLC	± -																	
1 PLC	± 0.2																	
2 PLC	± -																	
3 PLC	± -																	
4 PLC	± -																	
ANGLES	± -																	
MATERIAL PVC 6.12 - 5.54g/250mm		FINISH -	CUSTOMER DRAWING			SCALE 10:1	SHEET 1 OF 1	REV 10										

Mouser Electronics

Authorized Distributor

Click to View Pricing, Inventory, Delivery & Lifecycle Information:

[TE Connectivity:](#)

[EC1233-000](#)