

Medium Toggle Switch

Q-1270

TYPE: **KN3(B)-102A**

SPECIFICATIONS

Rating: 15A 125V AC; 10A 250V AC
 Contact R: 50mΩ max
 Insulation R: 500V DC 100MΩ min
 Dielectric Strength: 1 Minute 1500V AC
 Operating Temperature: -25°C ~ +85°C
 Electrical Life: 10, 000 Cycles

Outline Drawing

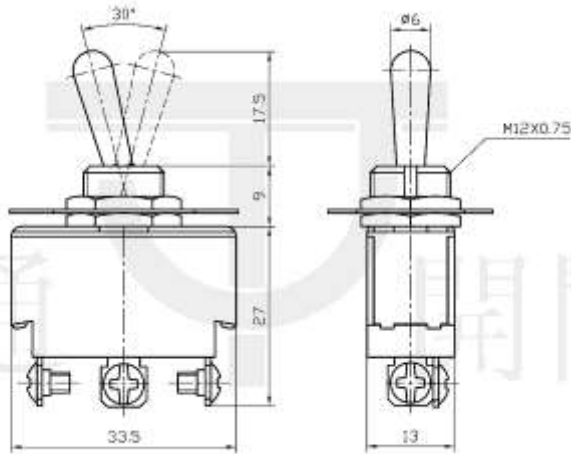

Mounting

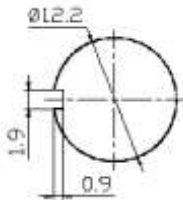

Circuitry

