

AEAT-9955

Magnetic Encoder IC: 10-Bit to 18-Bit Programmable Angular Magnetic Encoder with Safety

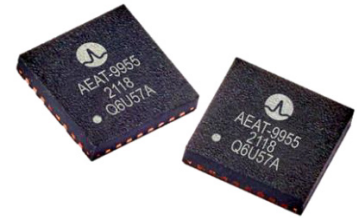

Description

The Broadcom[®] AEAT-9955 is an angular magnetic rotary sensor that provides accurate angular measurement over a full 360 degrees of rotation.

A sophisticated system uses integrated Hall sensor elements with complex analog and digital signal processing within a single device.

A simple two-pole magnet generates the necessary magnetic field by rotating it in perpendicular. Wide magnetic field sensor configurations allow On Axis (end of shaft) or Off Axis (side of shaft, axial and radial) modes in application.

The AEAT-9955 is a versatile solution capable of supporting a broad range of applications with its robust architecture to measure and deliver both absolute and incremental signals.

The absolute angle measurement provides an instant indication of the magnet's angular position with a selectable and reprogrammable resolution from 10 to 18 bits. When selected, its positioning data is then represented in its digital form to be assessed through a standard SSI (parity) and SPI (with CRC and Parity option) communication protocol.

Where desired, users may also choose to receive its absolute angle position in PWM-encoded output signals. The incremental positions are indicated on ABI and UVW signals with a wide user-configurable resolution from 1 CPR to 20,000 CPR of ABI signals and pole pairs from 1 to 32 pole pairs (2 to 64 poles) for UVW commutation signals.

Key Features

- 5V and 3.3V operating voltage
- Operating temperature from -40°C to 125°C
- 500- μA current consumption in Sleep mode
- Programmable 10 bits up to 18 bits of absolute resolution
- Programmable incremental ABI resolution ranging from 1 CPR to 20,000 CPR
- Commutation angle output UVW 1 pp to 32 pp
- Absolute output over 2-wire SSI, 3-wire SSI, 4-wire SPI, and PWM.
- Dedicated output pin for ABI, UVW, and serial interface
- Dedicated zero reset and error pin
- EEPROM architecture for multi-time user configuration
- Optional 56-bit memory lock function
- Automatic integral non-linearity angle correction for high accuracy
- Designed conformance to ISO26262 ASIL-D and SIL3 with secondary chip for redundancy
- Compact QFN-32 leads (5 mm \times 5 mm) package

Applications

- Brushless DC motor and stepper motor
- Resolver and potentiometer replacement
- Industrial automation and robotics
- Industrial sewing machine and textile equipment
- Light Detection and Range (LiDAR)

NOTE: This product is not specifically designed or manufactured for use in any specific device. Customers are solely responsible for determining the suitability of this product for its intended application and solely liable for all loss, damage, expense, or liability in connection with such use.

Functional Description

Figure 1: AEAT-9955 Block Diagram

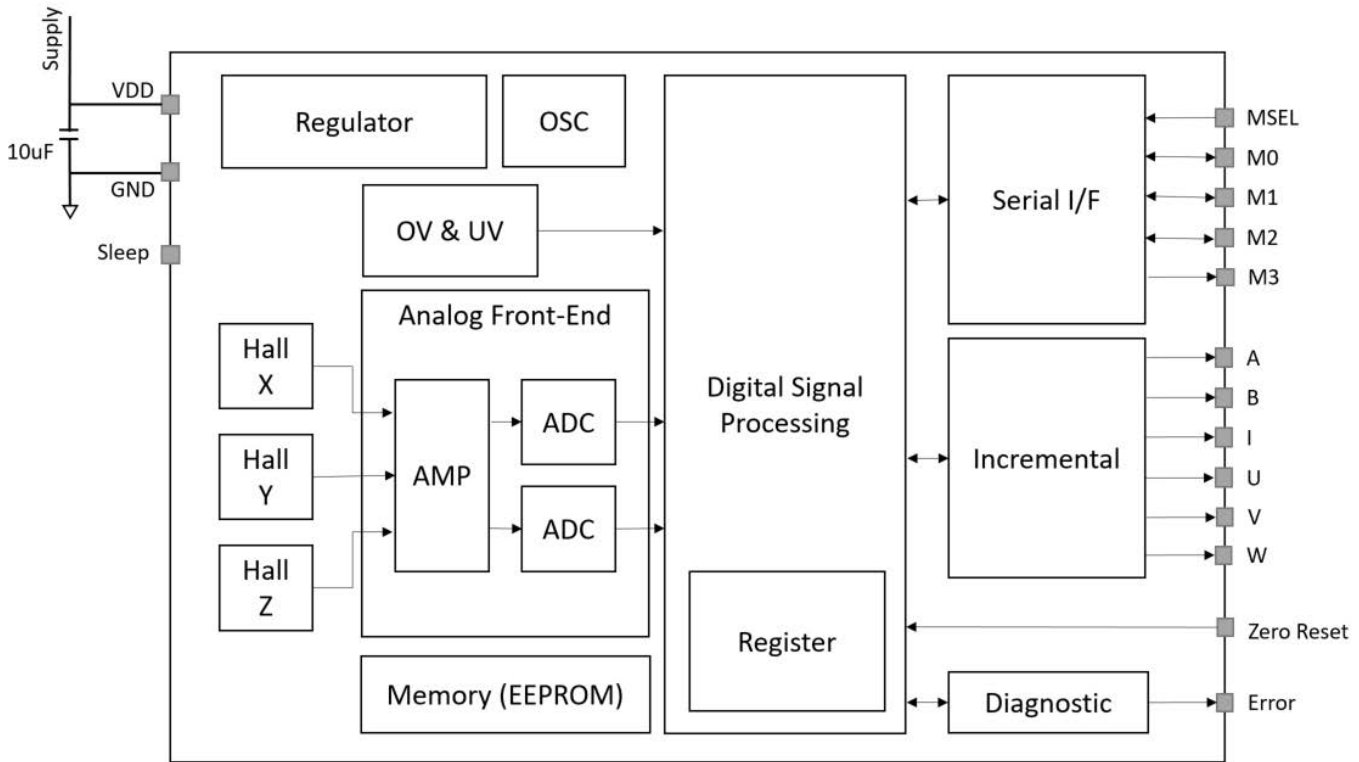

The AEAT-9955 is manufactured with a CMOS standard process. It is capable of accurately measuring a magnet’s rotational angle when it is placed in alignment and in perpendicular to the device by using its integrated Hall sensors to detect its magnetic field. The detected magnetic signals are then taken as input signals to be properly conditioned to negate its non-idealities before inputting them into the analog amplifiers for strength amplification and filtering. The amplified analog signals are then fed into the internal analog-to-digital converter (ADC) to be converted into digital signals for the final stage of digital processing. The digital processing provides a digitized output of the absolute and incremental signals.

The used magnet should have sufficient magnetic field strength mT to generate the magnetic field for the signal generation as highlighted in the [Recommended Magnetic Input Specifications](#) section. The device provides digital information of magnetic field strength high MHi and magnetic field strength low MLo from output protocols to indicate whether the magnets are too close or too far away from our device’s surface.

Users can assess the device’s digitized absolute data using standard Synchronous Serial Interface (SSI) or Serial Peripheral Interface (SPI) protocols. In addition, an absolute angular representation can also be selected using a pulse-width modulated (PWM) signal.

The incremental outputs are available from the digital outputs of their dedicated A, B, and I pins and the commutation output U, V, and W.

Pin Assignment

Figure 2: Pin Configurations

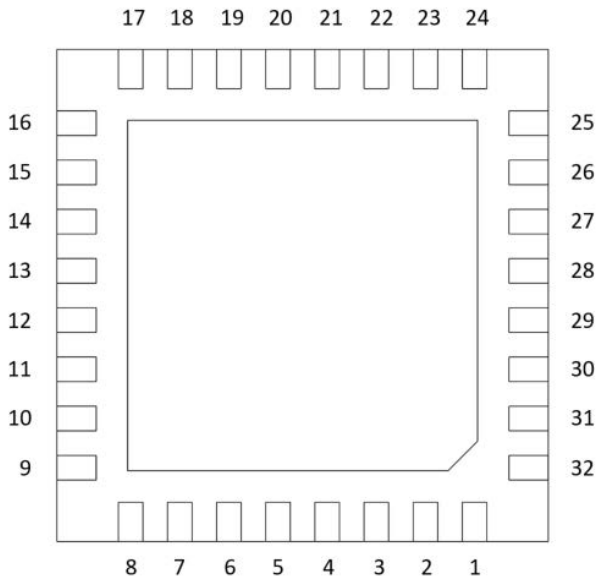

Pinout Description

Pin QFN32	Pin Name	Description	Pin QFN32	Pin Name	Description
1	n.c	—	17	Zero	Zero Reset
2	M0	Serial Interface M0	18	n.c	—
3	n.c	—	19	ERR	Error
4	M1	Serial Interface M1	20	n.c	—
5	n.c	—	21	MSEL	Interface Select
6	M2	Serial Interface M2	22	n.c	—
7	M3	Serial Interface M3	23	n.c	—
8	A	Incremental A	24	n.c	—
9	B	Incremental B	25	n.c	—
10	I	Incremental I	26	n.c	—
11	U	Commutation U	27	n.c	—
12	n.c	—	28	VSS	Ground Supply
13	V	Commutation V	29	n.c	—
14	n.c	—	30	VDD	Power Supply
15	W	Commutation W	31	n.c	—
16	Sleep	Sleep Mode	32	n.c	—

Absolute Maximum Ratings

Parameter	Symbol	Min.	Max.	Unit
Storage Temperature	T_S	-40	125	°C
DC Supply Voltage VDDA Pin	VDD	-0.3	6.06	Volts
Input Voltage Range	V_{in}	-0.3	6	Volts
Electrostatic Discharge (HBM)	—	-4.0	+4.0	kVolts
Moisture Sensitivity Level	—	—	1	—

CAUTION! Subjecting the product to stresses beyond those listed in this section may cause permanent damage to the devices. These are stress ratings only and do not imply that the devices will function beyond these ratings. Exposure to the extremes of these conditions for extended periods may affect product reliability.

Electrical Characteristics

Recommended Operating Conditions

Parameter	Symbol	Min.	Typ.	Max.	Unit	Notes
Operating Ambient Temperature	T_A	-40	—	125	°C	—
DC Supply Voltage to VDD Pin 5V Operation 3.3V Operation	VDD	4.5 3.0	5.0 3.3	5.5 3.6	Volts	—
Incremental Output Frequency	f_{MAX}	—	—	1.0	MHz	Frequency = Velocity(rpm) x CPR/60
Load Capacitance	C_L	—	—	15	pF	—

Systems Parameters

Condition: Electrical characteristics over the recommended operating conditions. Typical values specified at VDD = 5.0V and 25°C, optimum placement of magnet.

Parameter	Symbol	Min.	Typ.	Max.	Unit	Notes
Current Consumption						
Supply Current Normal Operation Mode	IDD _{NOM}	—	24	—	mA	5V
	IDD _{NOM}	—	22	—	mA	3.3V
Supply Current Sleep Mode	IDD _{IDLE}	—	350	—	μA	5V & 3.3V
Digital Outputs (DO)						
High Level Output Voltage	V _{OH}	VDD – 0.5	—	—	Volts	Normal operation
Low Level Output Voltage	V _{OL}	—	—	GND + 0.4	Volts	—
Power-up time Absolute Output Incremental Output PWM Output	t _{PwrUp}	—	10	—	ms	—
Digital Inputs (DI)						
Input High Level	V _{IH}	0.7 x VDD	—	—	Volts	—
Input Low Level	V _{IL}	—	—	0.3 x VDD	Volts	—
Pull-Up Low Level Input Current	I _{IL}	—	—	120	μA	—
Pull-Down High Level Input Current	I _{IH}	—	—	120	μA	—

Encoding Characteristics

Parameter	Symbol	Min.	Typ.	Max.	Unit	Notes
Absolute Output						
Resolution	RES	10	—	18	Bit	Programmable 10 to 18 bits.
Integral Non-Linearity ON-Axis	INL _{nom}	—	±0.05	—	Deg	Best fit line, centered magnet. T _A = 25°C Voltage = 5V INL angle correction.
Integral Non-Linearity OFF-Axis		—	±0.15	—		
Integral Non-Linearity ON-Axis	INL _{dis}	—	±0.15	—	Deg	Best fit line, over displacement of magnet. T _A = 25°C Voltage = 5V
Integral Non-Linearity OFF-Axis		—	±0.25	—		
Integral Non-Linearity ON-Axis	INL _{temp}	—	±0.10	—	Deg	Best fit line, over temperature range. T _A = -40 to +125°C Voltage = 5V
Integral Non-Linearity OFF-Axis		—	±0.40	—		
Differential Non-Linearity	DNL _{nom}	—	±0.02	—	Deg	T _A = 25°C Voltage = 5V
Output Sampling Rate	f _S	—	10	—	MHz	Based on the SSI protocol.
Latency	—	—	80	—	ns	At constant speed.
Incremental Output (Channel ABI)						
Resolution	R _{INC}	1	—	20000	CPR	Programmable.
Index Pulse Width	P _O	90	—	360	°e	Programmable options: 90, 180, 270, or 360 °e. See Figure 3 .
Index Pulse State	P _S	90	—	360	°e	Relation between Index output to Incremental AB state. Programmable options: 0, 90, 180, or 270°e. See Figure 3 .
Index State	—	90	—	360	°e	Programmable options: 90, 180, 270, or 360 °e. See Figure 3 .
PWM Output						
PWM Frequency	f _{PWM}	122	—	976	Hz	Adjustable based on our PWM settings.
Minimum Pulse Width	PW _{MIN}	—	1	—	µs	—
Maximum Pulse Width	PW _{MAX}	—	16384	—	µs	—

NOTE: Encoding characteristics over recommended operating range unless otherwise specified.

Recommended Magnetic Input Specifications

Parameter	Symbol	Min.	Typ.	Max.	Unit	Notes
Diameter Disc magnet	d	4	6	—	mm	Recommended magnet: Cylindrical magnet or ring magnet diametrically magnetized and one pole pair.
Ring magnet ID		—	ID,15	—	mm	
/OD		—	OD,25	—	mm	
Thickness Disc magnet	t	—	2.5	—	mm	
Ring magnet		2	6	—	mm	
Magnetic input field magnitude On-axis (disc magnet)	B _{pk}	45	—	100	mT	
Off-axis (ring magnet)		30	—	150	mT	
Magnet displacement radius	R _m	—	—	0.25	mm	Displacement between the magnet axis and the device center.
Recommended magnet material and temperature drift	—	—	-0.12	—	%/K	NdFeB (Neodymium Iron Boron), grade N35SH.



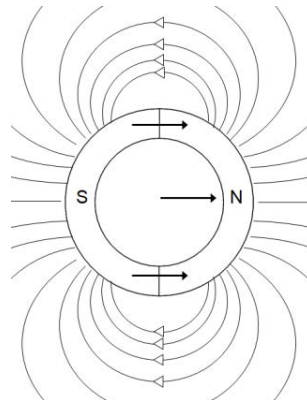
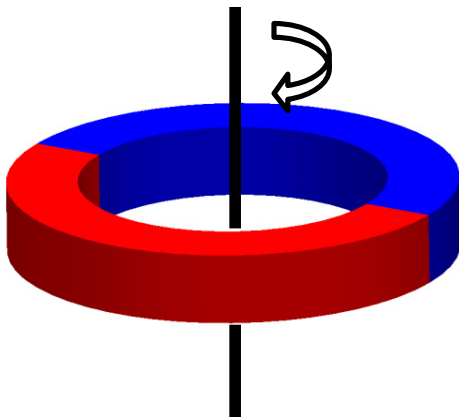
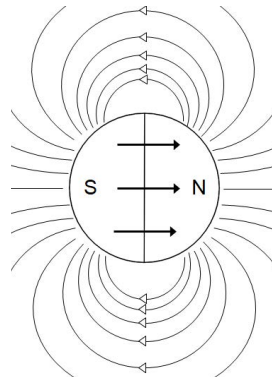
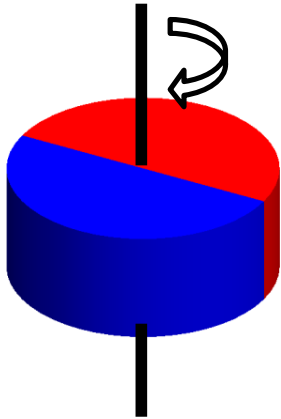



Diametrically Magnetized Magnet

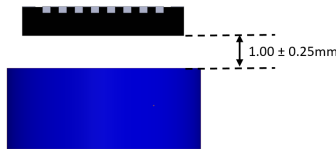
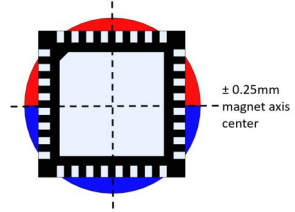
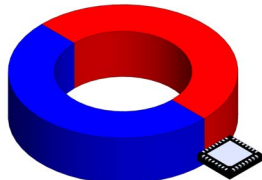
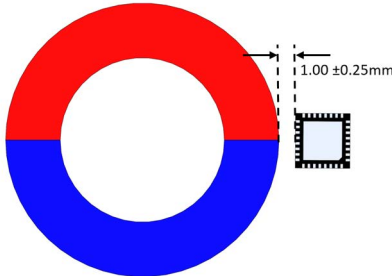

Magnet and IC Package Placement

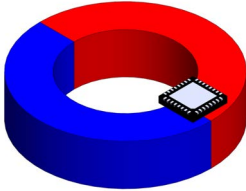
AEAT-9955 multi-axis capability comes from multiple integrated Hall devices that allow flexibility on the sensor mounting with respect to the magnet. Generally, the shaft end configuration senses the vertical field (Z component perpendicular to the chip surface), and the rest of the configuration senses the horizontal field (X and Y components parallel to the chip surface).

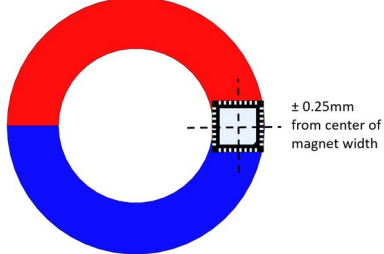
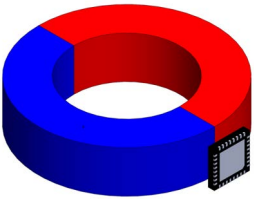
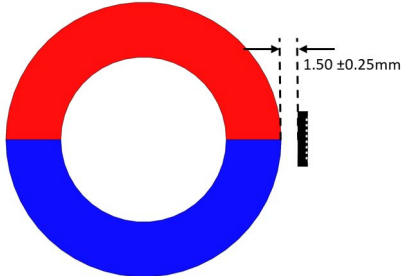
The nominal mounting tolerance is indicated the following table.

Configuration	Gap Tolerance	X-Y Tolerance
<p>Shaft End</p> 		
<p>Side Shaft</p> 		
<p>Axial</p> 		
<p>Radial</p> 		

Serial Interface Format

The AEAT-9955 serial interface hosts up to 10 different protocols for position output and memory access. The protocol is configurable with the combination of the physical I/O MSEL and M0 and memory settings PSEL, SPI4[0], and SPI4[1]. The default factory setting is all zeros, which is either SPI3 or SPI4-16a depending on the MSEL state.

All protocol selection can be switched during operation.

MATS Table

Mode Pin	SPI3	SSI3a	SSI3b	SSI2a	SSI2b	SPI4-16a	SPI4-16b	SPI4-16c	SPI4-8	PWM
MSEL	0	0	0	0	0	1	1	1	1	1
PSEL	x	0	1	0	1	0	0	0	0	1
SPI4[1]	x	x	x	x	x	0	0	1	1	x
SPI4[0]	x	x	x	x	x	0	1	0	1	x
M0	0	1	1	1	1	NCS	NCS	NCS	NCS	-
M1	DIN	NSL	NSL	0	0	MOSI	MOSI	MOSI	MOSI	-
M2	SCK	SCL	SCL	SCL	SCL	SCK	SCK	SCK	SCK	-
M3	DO	DO	DO	DO	DO	MISO	MISO	MISO	MISO	PWM

NOTE: PSEL, SPI4[1], and SPI4[0] are configured through memory.
MSEL and M0 are configured through I/O pads.

Serial Peripheral Interface (SPI3)

SPI3 protocols allow access to memory read write only. Assert 0 on the MSEL and M0 pin to configure it. The SPI is implemented with CPOL=0 and CPHA=0; data is propagated on the clock falling edge.

- M1 → SPI_Data Input (DIN) signal for the SPI protocol, input to the AEAT-9955.
- M2 → SPI_Clock Input (SCK) signal for the SPI protocol, input to the AEAT-9955.
- M3 → SPI_Data Output (DO) signal for the SPI protocol, output from the AEAT-9955.

SPI3 Timing Diagram

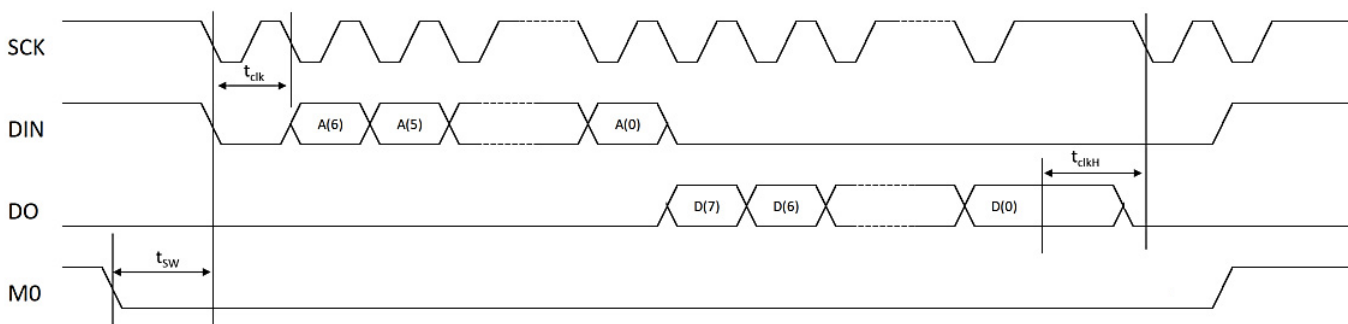

Symbol	Description	Min.	Typ.	Max.	Unit
t _{sw}	Time between the SCn falling edge and the CLK rising edge	1	—	—	µs
t _{clk}	Serial clock period	—	—	100	ns
t _{clkH}	CLK high time after the end of the last clock period	300	—	—	ns

NOTE: The user should read back data to confirm that it has been written successfully.

SPI3 Read

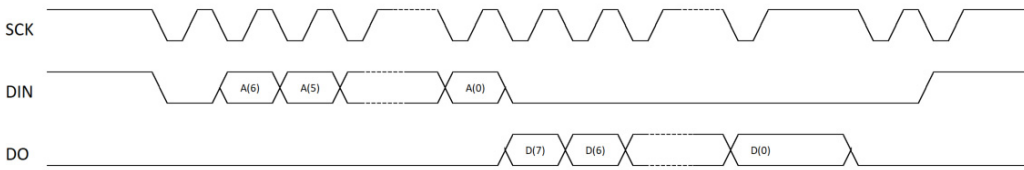

SPI3 Write

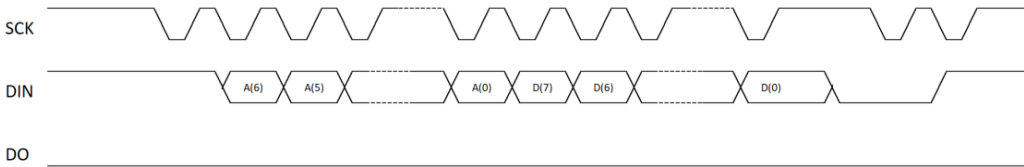

Serial Peripheral Interface (SPI4)

The SPI protocol uses four pins from the AEAT-9955. These four pins are shared between the UVW, SSI, and SPI protocols. To select the SPI4 protocol, assert 1 on the MSEL pin.

SPI4 protocols allow the user to access memory read or write and position data. It uses CPOL=0, CPHA=1 for triggering.

- M0 → SPI_Chip Select (NCS) signal for the SPI protocol, input to the AEAT-9955.
- M1 → SPI_Data Input (MOSI) signal for the SPI protocol, input to the AEAT-9955.
- M2 → SPI_Clock Input (SCK) signal for the SPI protocol, input to the AEAT-9955.
- M3 → SPI_Data Output (MISO) signal for the SPI protocol, output from the AEAT-9955.

SPI4 Timing Diagram

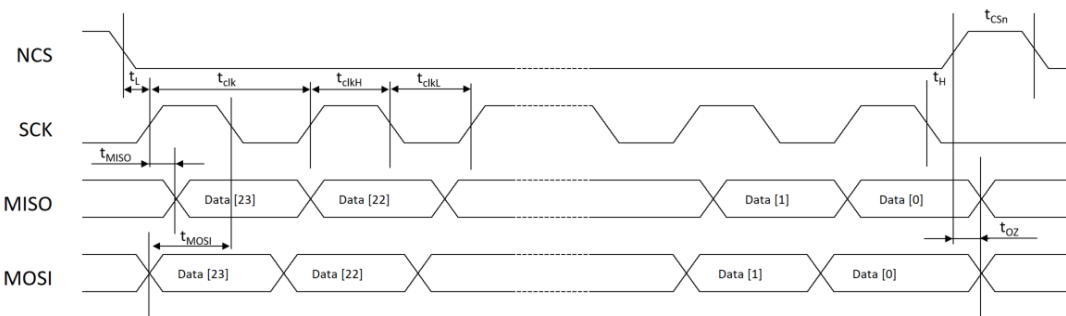

Symbol	Description	Min.	Typ.	Max.	Unit
t_L	Time between the SCn falling edge and the CLK rising edge	350	—	—	ns
t_{clk}	Serial clock period	100	—	—	ns
t_{clkL}	Low period of the serial clock	50	—	—	ns
t_{clkH}	High period of the serial clock	50	—	—	ns
t_H	Time between the last falling edge of CLK and the rising edge of CSn	$t_{clk}/2$	—	—	ns
t_{CSn}	High time of CS between two transmissions	350	—	—	ns
t_{MOSI}	Data input valid to clock edge	20	—	—	ns
t_{MISO}	CLK edge to data output valid	—	51	—	ns
t_{OZ}	Time between the CSn rising edge and the MISO HiZ	—	10	—	ns

NOTE: The user should read back data to confirm that it has been written successfully.

SPI4 Command and Data Frame

SPI4 Read Sequence

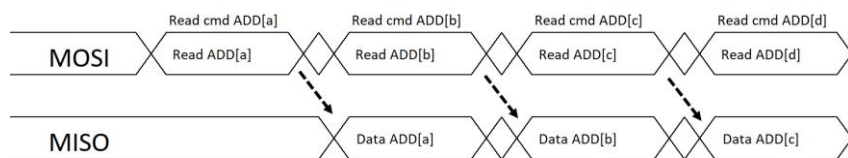

SPI4 Write Sequence

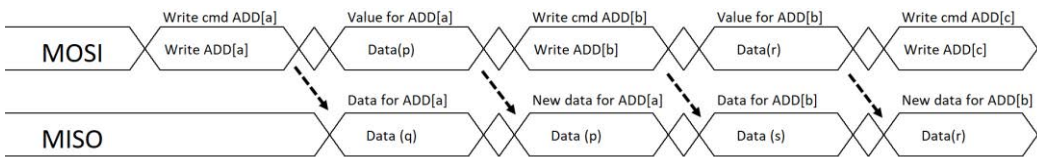

SPI4(A) 16-Bit (Parity)

By default, the chip is configured to SPI4 16-bit selection; PSEL = 0, SPI4[1] = 0, SPI4[0] = 0 in the register setting.

		Data Format																			
		19	18	17	16	15	14	13	12	11	10	9	8	7	6	5	4	3	2	1	0
Controller to Peripheral	P	RW	0	0	0	0	0	0	0	0	Addr/Data[7:0]										
Peripheral to Controller (memory)	P	EF	0	0	0	0	0	0	0	0	Data[7:0]										
Peripheral to Controller (pos 10b)	P	EF	Pos[9:0]										0	0	0	0					
Peripheral to Controller (pos 11b)	P	EF	Pos[10:0]										0	0	0	0					
Peripheral to Controller (pos 12b)	P	EF	Pos[11:0]										0	0							
Peripheral to Controller (pos 13b)	P	EF	Pos[12:0]										0								
Peripheral to Controller (pos 14b)	P	EF	Pos[13:0]																		
Peripheral to Controller (pos 15b)	P	EF	Pos[14:0]																		
Peripheral to Controller (pos 16b)	P	EF	Pos[15:0]																		
Peripheral to Controller (pos 17b)	P	EF	Pos[16:0]																		
Peripheral to Controller (pos 18b)	P	EF	Pos[17:0]																		

P: Parity
EF: Error Flag
RW: Read = 1, Write = 0

SPI4(B) 24-Bit (CRC)

To configure the chip to SPI4 24-bit selection, set PSEL = 0, SPI4[1] = 0, SPI4[0] = 1 in the register setting.

		Data Format																											
		27	26	25	24	23	22	21	20	19	18	17	16	15	14	13	12	11	10	9	8	7	6	5	4	3	2	1	0
Controller to Peripheral	0	RW	0	0	0	0	0	0	0	Addr/Data[7:0]										CRC[7:0]									
Peripheral to Controller (memory)	W	E	0	0	0	0	0	0	0	Data[7:0]										CRC[7:0]									
Peripheral to Controller (pos 10b)	W	E	Pos[9:0]										0	0	0	0	CRC[7:0]												
Peripheral to Controller (pos 11b)	W	E	Pos[10:0]										0	0	0	CRC[7:0]													
Peripheral to Controller (pos 12b)	W	E	Pos[11:0]										0	0	CRC[7:0]														
Peripheral to Controller (pos 13b)	W	E	Pos[12:0]										0	CRC[7:0]															
Peripheral to Controller (pos 14b)	W	E	Pos[13:0]										CRC[7:0]																
Peripheral to Controller (pos 15b)	W	E	Pos[14:0]										CRC[7:0]																
Peripheral to Controller (pos 16b)	W	E	Pos[15:0]										CRC[7:0]																
Peripheral to Controller (pos 17b)	W	E	Pos[16:0]										CRC[7:0]																
Peripheral to Controller (pos 18b)	W	E	Pos[17:0]										CRC[7:0]																

W: Warning
E: Error
RW: Read = 1, Write = 0

Position Read

Absolute position data can be obtained by sending a read command to address 0x3F.

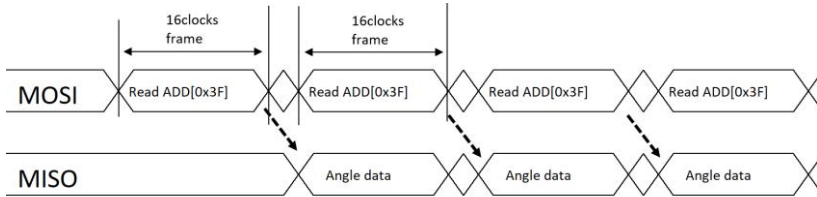

In the event of higher single-turn resolution (15-bit and above), the command and data frame size is adjusted accordingly.

Example: 18bit + 2bit (parity and error)

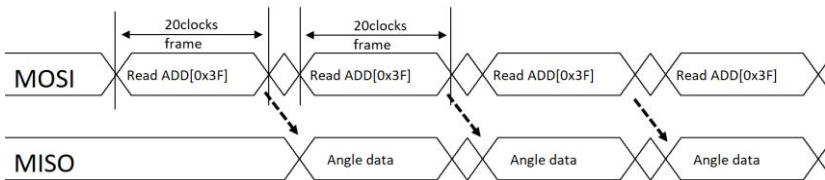

SPI4-8

To configure the chip to SPI4 24-bit selection, set PSEL = 0, SPI4[1] = 1, SPI4[0] = 1 in the register setting.

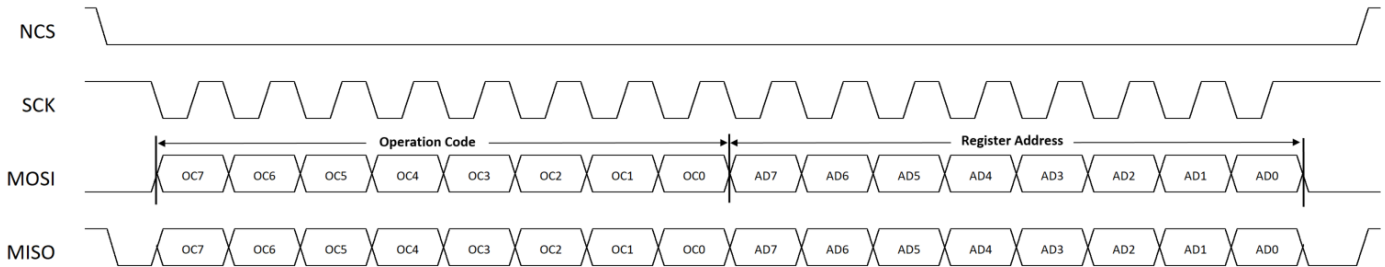

When NCS is low, the communication line is activated and the data is sampled on the rising edge of SCK.

The MISO state turns to high impedance mode (hi-Z) when NCS is high. The transmission works over specific operation code (OC).

Register Read (OC=0x81'h)

This operation is used to read data from the internal register of the chip. It can be performed consecutively starting from any register address. The data continues to be transmitted as long the clock (SCK) is sent and the chip select (NCS) remains active.

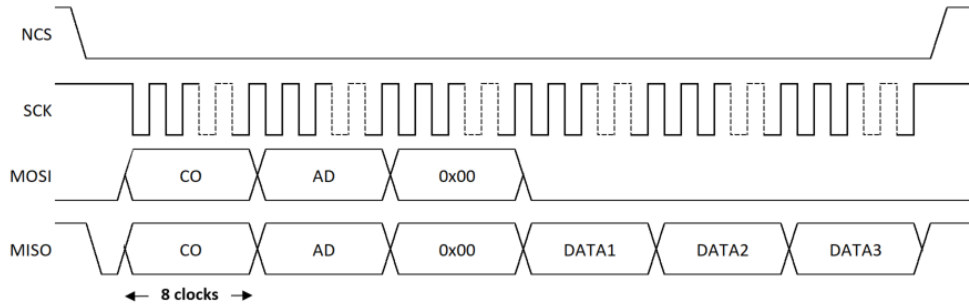

Register Write (OC=0xCF'h)

This operation is used to write data into the internal register of the chip. It can be performed consecutively starting from any register address. The subsequent data byte is written into the next register address (AD+1), while the NCS signal stays active. Complete written data is transmitted back via MISO.

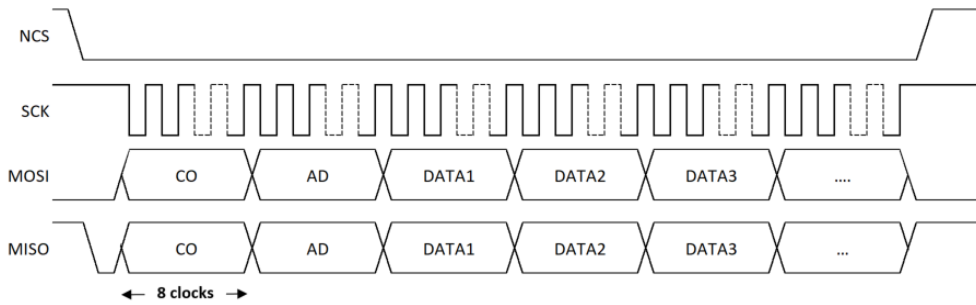

Position Read (OC=0xA6'h)

Read the absolute position by sending the operation code, and the data will be transmitted on the MISO line. The position data consists of the single-turn position data length and status byte. The position data length follows the single-turn resolution setting.

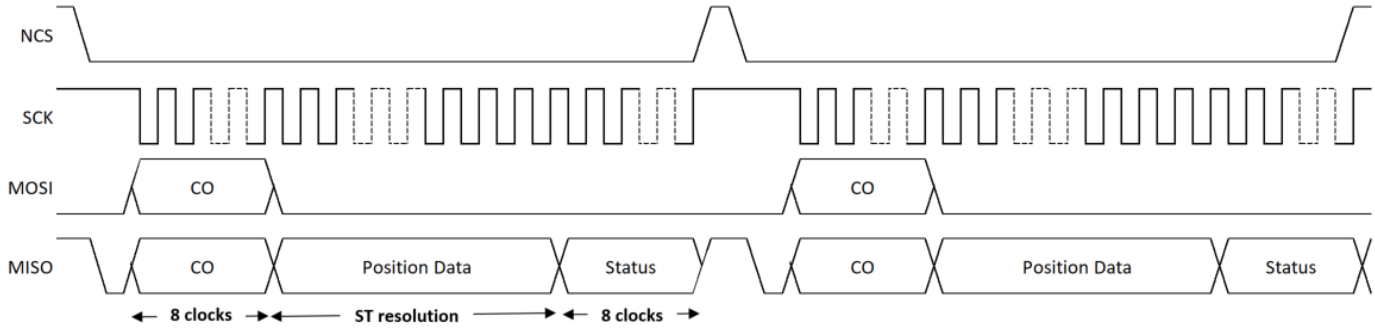

For safety format, there are additional bytes: sequence counter (SC) and CRC.

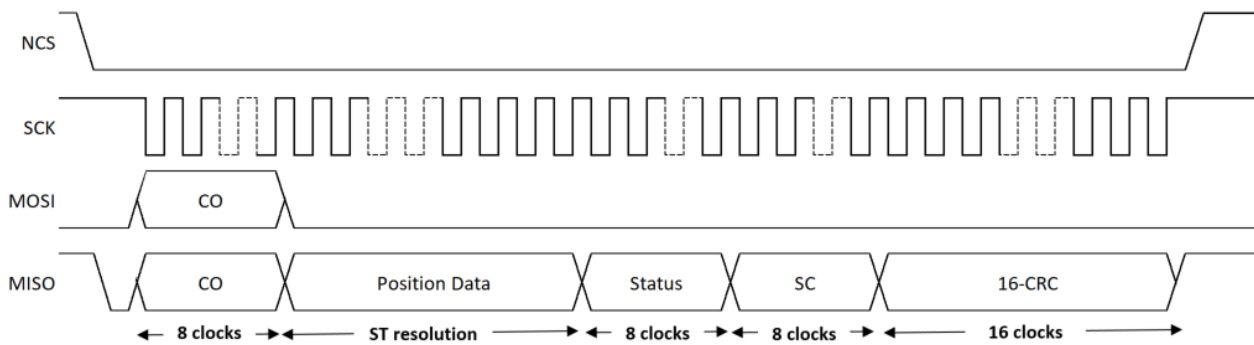

Serial Synchronous Interface 3-Wire (SSI3)

The SSI3 protocol uses three pins from the AEAT-9955. These three pins are shared between the UVW, SSI, and SPI protocols. To activate the SSI3 protocol, assert 0 on the MSEL pin and assert 1 on the M0 pin.

- M1 → SSI_NSL Input (NSL) signal for the SSI protocol, input to the AEAT-9955.
- M2 → SSI_Clock Input (CLK) signal for the SSI protocol, input to the AEAT-9955.
- M3 → SSI_Data Output (DO) signal for the SSI protocol, output from the AEAT-9955.

It is available in two options per PSEL register setting.

SSI Protocol Timing Diagram. Default: Data Output with 3-Wire SSI to 10-MHz Clock Rates

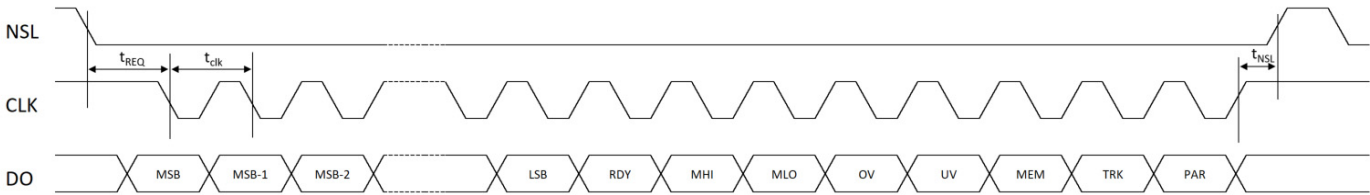

Symbol	Description	Min.	Typ.	Max.	Unit
t_{clk}	SSI_SPI_SEL switch time	1	—	—	μ s
t_{REQ}	SCL high time between the NSL falling edge and the first SCL falling edge	300	—	—	ns
t_{NSL}	NSL high time between two successive SSI reads	200	—	—	ns

SSI-3(A)

By default, the chip is configured to SSI-3(A) selection; PSEL = 0 in the register setting.

The DO pin is held at a high state once the NSL pin is high.

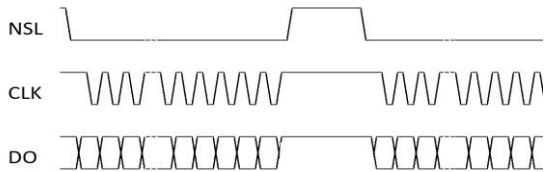

SSI-3(B)

To configure the chip to SSI-3(B) selection, set PSEL = 1 in the register setting.

The DO pin is at a tristate (high-impedance) state once the NSL pin is high.

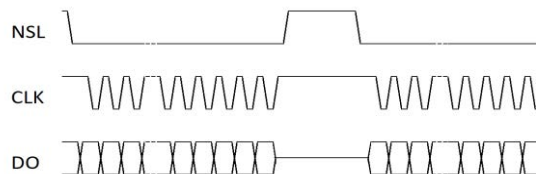

Serial Synchronous Interface 2-Wire (SSI2)

The SSI2 protocol uses two pins from the AEAT-9955. These two pins are shared between the SSI and SPI protocols. To activate the SSI2 protocol, assert 0 on the MSEL and M1 pins and assert 1 on the M0 pin upon power-up.

- M2 → SSI_Clock Input (CLK) signal for the SSI protocol, input to the AEAT-9955.
- M3 → SSI_Data Output (DO) signal for the SSI protocol, output from the AEAT-9955.

Depending on the PSEL setting, it can be configured as SSI2(A) Ring Mode or SSI2(B) No Ring Mode.

Data is latched on the first CLK falling edge and is transmitted on the next falling edge.

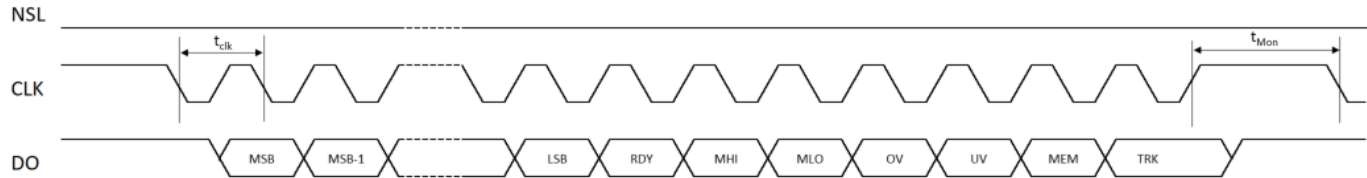

Symbol	Description	Min.	Typ.	Max.	Unit
t_{Clk}	NSL low time after the rising edge of the last clock period for an SSI read	250	—	$t_M/2$	ns
t_M	NSL high time between two successive SSI reads	—	16.5	18.0	μ s

SSI-2(A)

By default, the chip is configured to SSI-2(A) selection; PSEL = 0 in the register setting.

Outputs single data position and remains low after LSB until the next monoflop (t_M) expires.

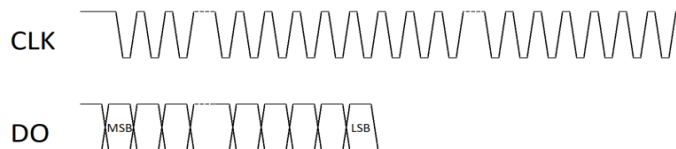

SSI-2(B)

To configure the chip to SSI-2(B) selection, set PSEL = 1 in the register setting.

The same position data can be continuously output by sending clock train, and the data is separated by a single low pulse.

Data will be refreshed when the next monoflop (t_M) expires.

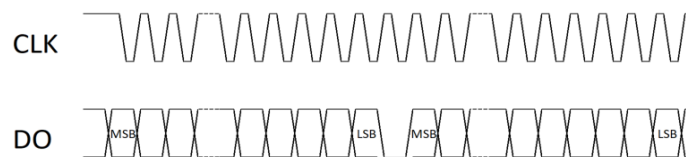

SSI READ Data Format

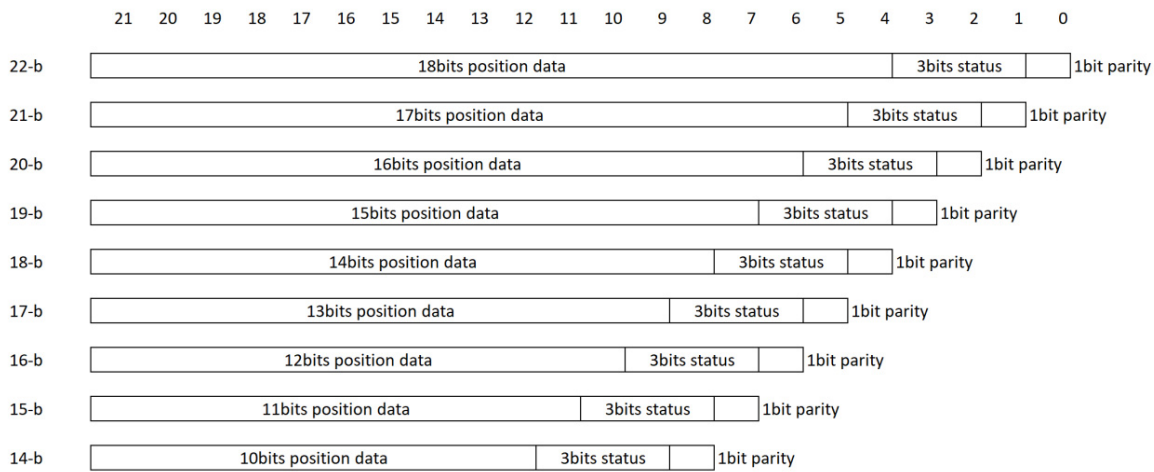
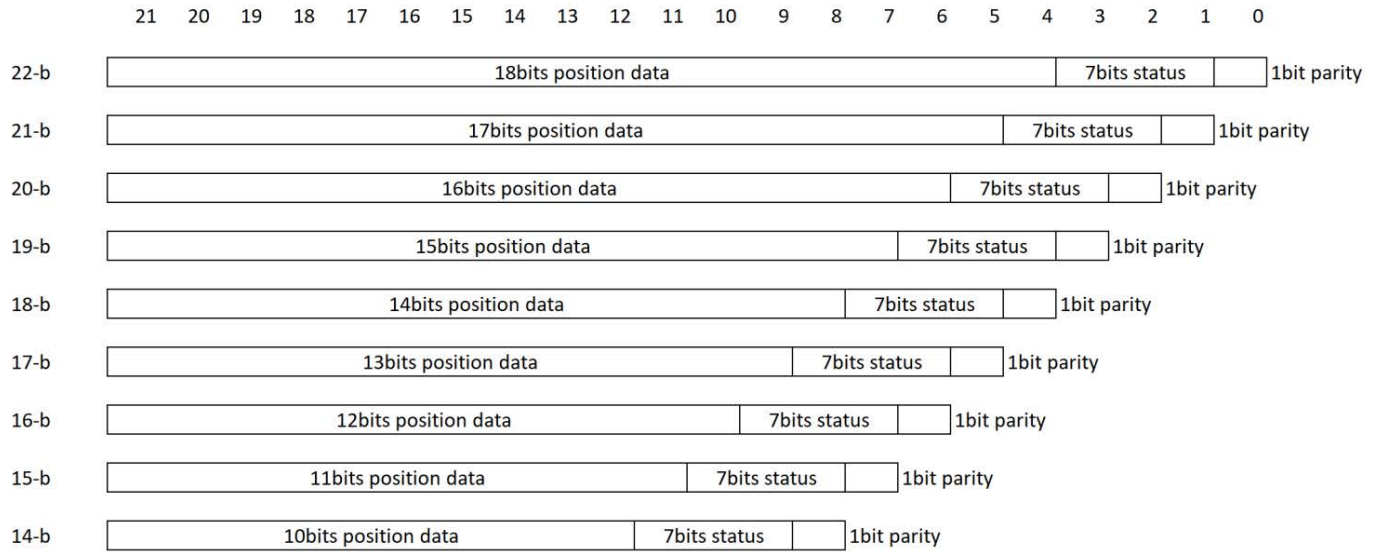

NOTE:

- 7-b status: {Ready, MHI, MLO, OV, UV, Mem, Trck}
- See [Status and Alarm](#) for more details.

Safety and Non-safety Protocol Format

The position serial interface is available in Safety and Non-safety format; applicable for SSI3, SSI2, and SPI-8.

Position (n-bit)	Status / Alarm (7-bit)							Parity (1-bit)
Position[(n-1):0]	READY	MHI	MLO	OV	UV	MEM	TRK	parity

Position (n-bit)	Status / Alarm (8-bit)							SC (8-bit)	CRC (8/16-bit)
Position[(n-1):0]	Status[1:0] ⁽¹⁾	MHI	MLO	OV	UV	MEM	TRK	SC [7:0] ⁽²⁾	CRC [7/15:0] ⁽³⁾

NOTE:

- 2-bit status to indicate the safety status:
 - Status = 2b'00 – Encoder not ready.
 - Status = 2b'01 – Encoder not ready, Force test failed.
 - Status = 2b'10 – Encoder not ready.
 - Status = 2b'11 – Encoder not ready, Force test passed.
- SC denotes as “Sequence Count” or life counter that automatically increments on every position transmission. The counting starts from 1 to 255, and the initial value upon power-up is configurable.
- CRC poly 0x1021 or 0x1D, initial value is configurable (0x0000, 5555, AAAA, FFFF).

Status and Alarm

The error bit is triggered if Magnet High (MHI), Magnet Low (MLO), Memory Error (MEM), or communication error.

Details of the error bit are available in the following register address.

Address	bit							
	7	6	5	4	3	2	1	0
0x21	RDY	MHI	MLO	OV	UV	MEM	TRK	

- **Ready:** The chip is ready, and the ready value is 1.
- **Parity:** 1-b parity is even parity.
- **Magnet High (MHI) Error:** This indicates that the magnet strength detected by the chip is too strong. When this is set high consistently, change to a weaker magnet or increase the distance between the chip and the magnet. The value for this alarm is represented as 1.
- **Magnet Low (MLO) Error:** This indicates that the magnet strength detected by the chip is too weak. When this is set low consistently, change to a stronger magnet or decrease the distance between the chip and the magnet. The value for this alarm is represented as 1.
- **Overvoltage (OV) Error:** This indicates that the input supply has exceeded the limit. When this is set high consistently, check the supply line. The value for this alarm is represented as 1.
- **Undervoltage (UV) Error:** This indicates that the input supply has dropped below the limit. When this is set high consistently, check the supply line. The value for this alarm is represented as 1.
- **Memory Error (MEM) Error:** This indicates that memory corruption has occurred. When this is set high, perform a power-cycle to reload the memory. The value for this alarm is represented as 1.
- **Tracker (TRK) Error:** This indicates that the angular error has exceeded 5° within 5 ms. When this is set high consistently, perform a power-cycle to re-initialize the sensor. The value for this alarm is represented as 1.

Power Modes

The AEAT-9955 is designed with two power modes:

- **Active Mode** where the chip operates under full functions with normal current consumption, $I_{DD_{NOM}}$.
- **Sleep Mode** powers down the chip front-end and digital processing blocks, leaving only the detection block to track on user input with low current consumption, $I_{DD_{IDLE}}$.

PWM

The PWM protocol uses one output pin (W_PWM) from the AEAT-9955. Note that the W_PWM pin is shared between the UVW and PWM protocols. The PWM signals are configurable to have a period of 1025, 2049, 4097, 8193, or 16385 μ s. During power-up, the PWM signal is 0 before chip ready.

PWM Signals (Period = 1025/2049/4097/8193/16385 μ s)

PWM Period: 1025, 2049, 4097, 8193, 16385 μ s

PWM Period: 1025us

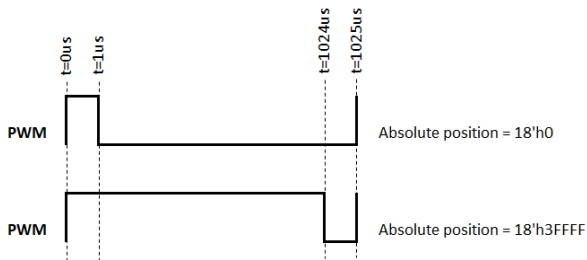

PWM Period: 2049us

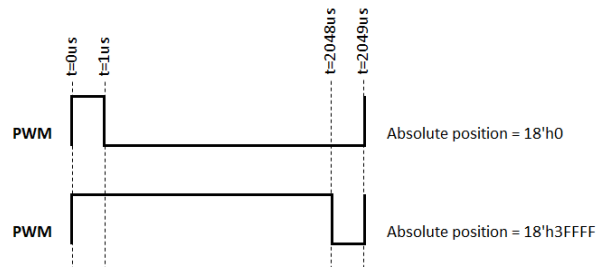

PWM Period: 4097us

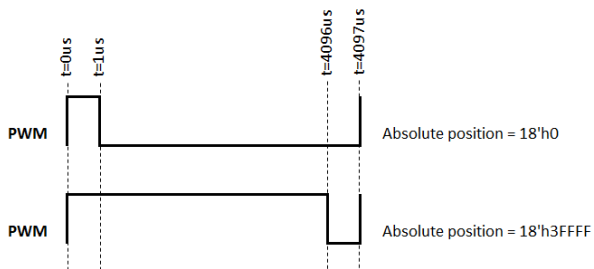

PWM Period: 8193us

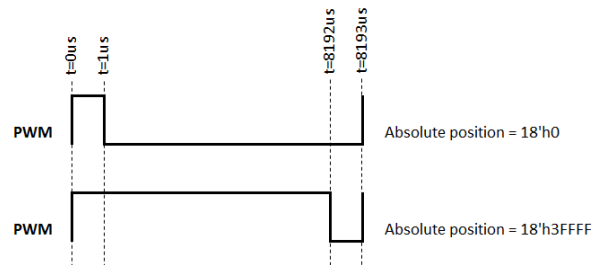

PWM Period: 16385us

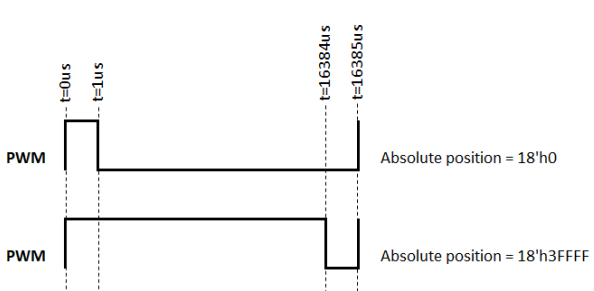

The PWM protocol is also available with Init, Error_n, and Exit along with Data information.

PWM Signals (Period = 1047/2071/4119/8215/16407 μs)

PMW Period: 4119 μs

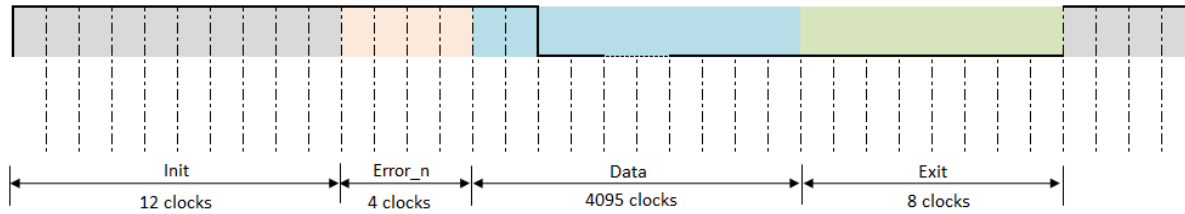

Incremental Output Format

The AEAT-9955 provides ABI and UVW signals to indicate the incremental position of the motor.

ABI

The ABI incremental interface is available to provide position data and direction data from the three output pins (A, B, and I).

The index signal marks the absolute angular position and typically occurs once per revolution. The ABI signal is configurable using the memory map registers. It supports the following configuration:

- Programmable CPR: 1 to 10,000 CPR
- Programmable I-width: 90, 180, 270, or 360 electrical degrees (edeg)
- Programmable I-state: 90, 180, 270, or 360 electrical degrees (edeg)

Figure 3: ABI Signal (4096 CPR, with Different I-Width Settings), Assuming the User Sets Hysteresis at 0.02 Mechanical Degrees

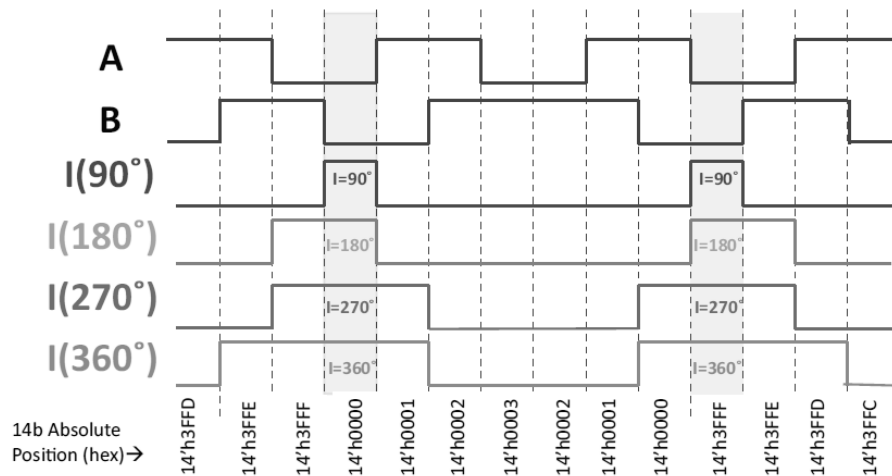

The index position is configurable among the incremental states.

The index signal rises high once per turn at the absolute zero position.

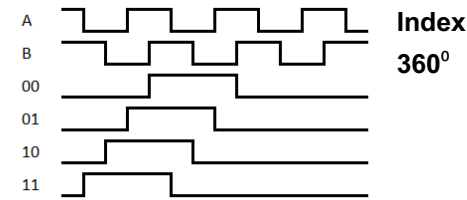
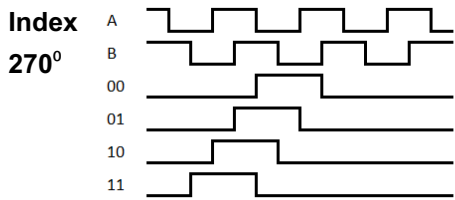
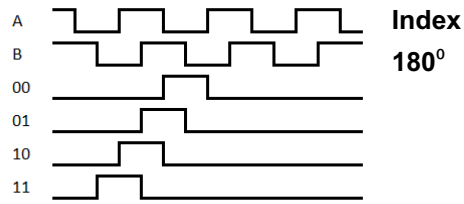
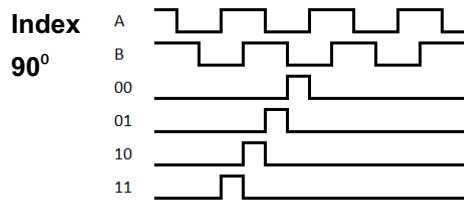

UVW

Three-channel integrated commutation output (U, V, W) emulates Hall sensor feedback and is available using three output pins. Note that the W_PWM pin is shared between the UVW and PWM protocols.

The AEAT-9955 can configure pole pairs from 1 to 32 (equivalent to 2 to 64 poles).

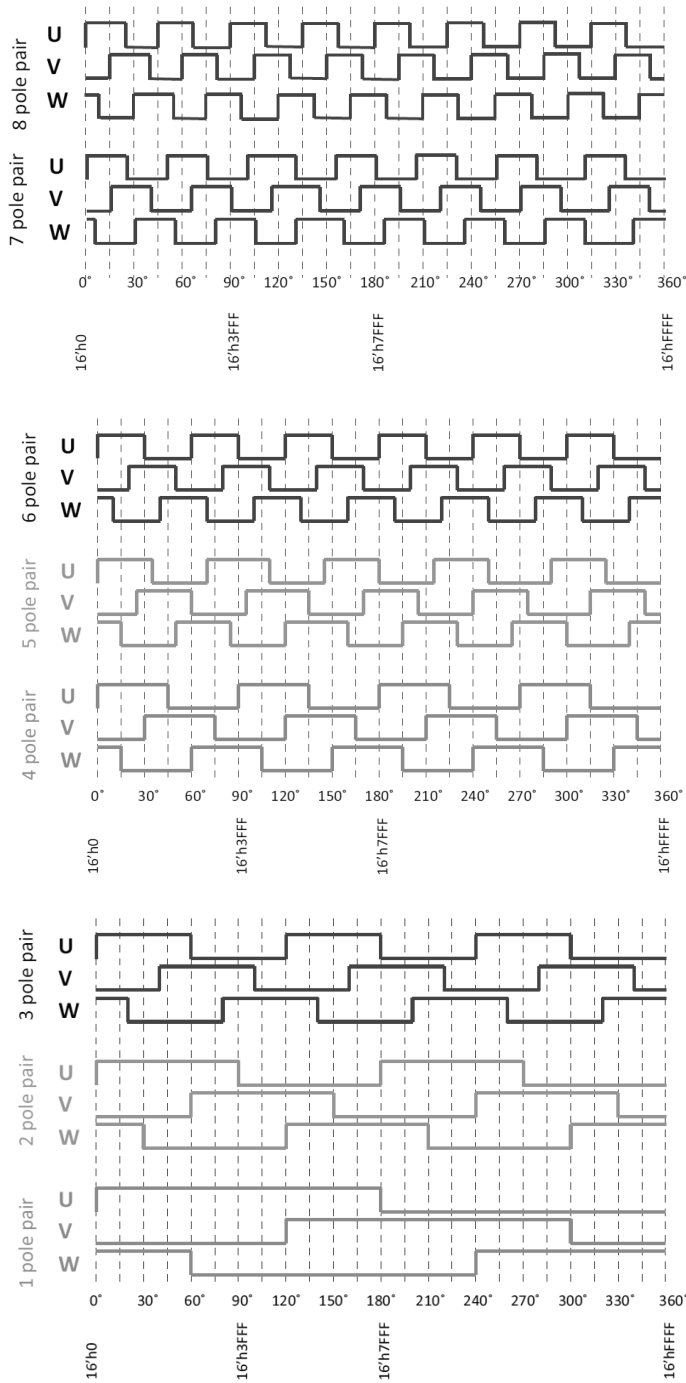

Note that signal U from the UVW protocol is tagged to signal I from the ABI protocol as shown in the following figure.

Figure 4: U-to-I Tagging

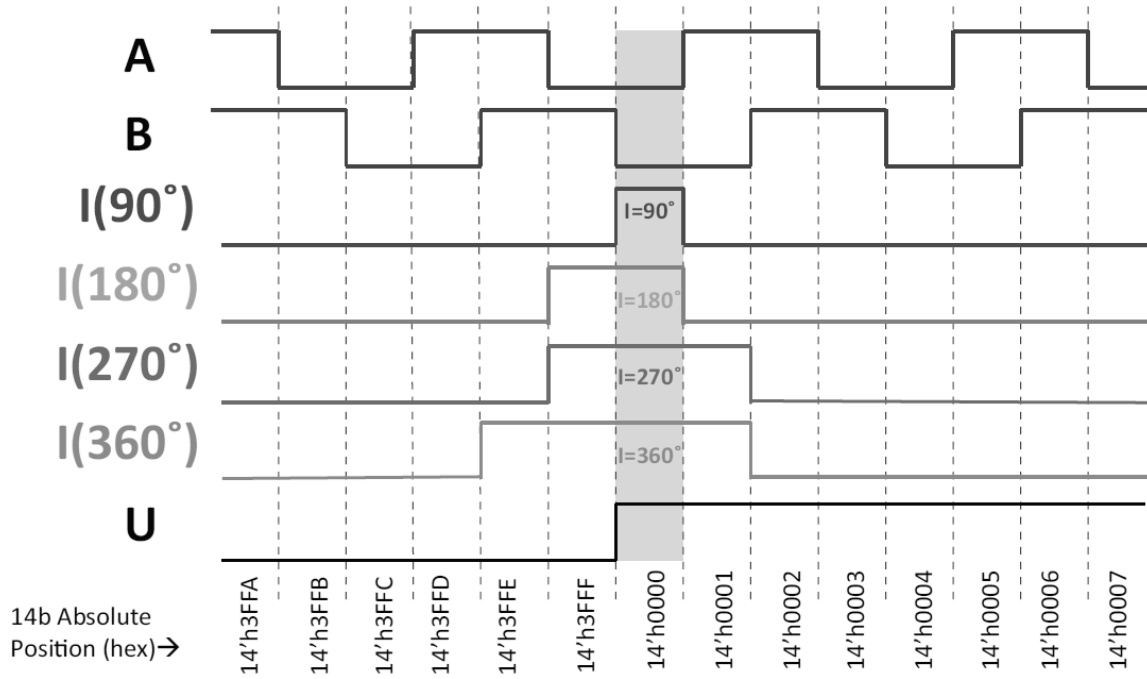

Package Drawings (in mm)

Figure 5: AEAT-9955, 32 QFN Dimensions

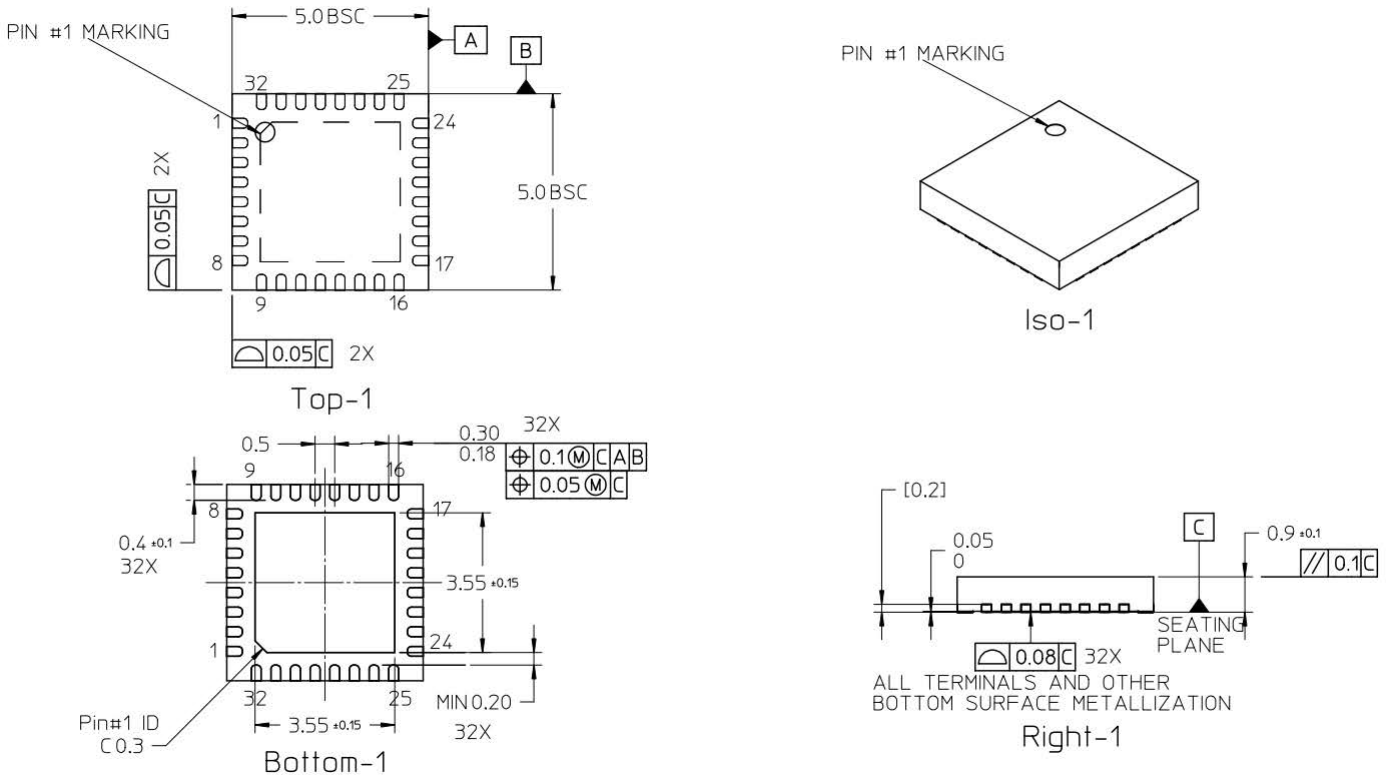
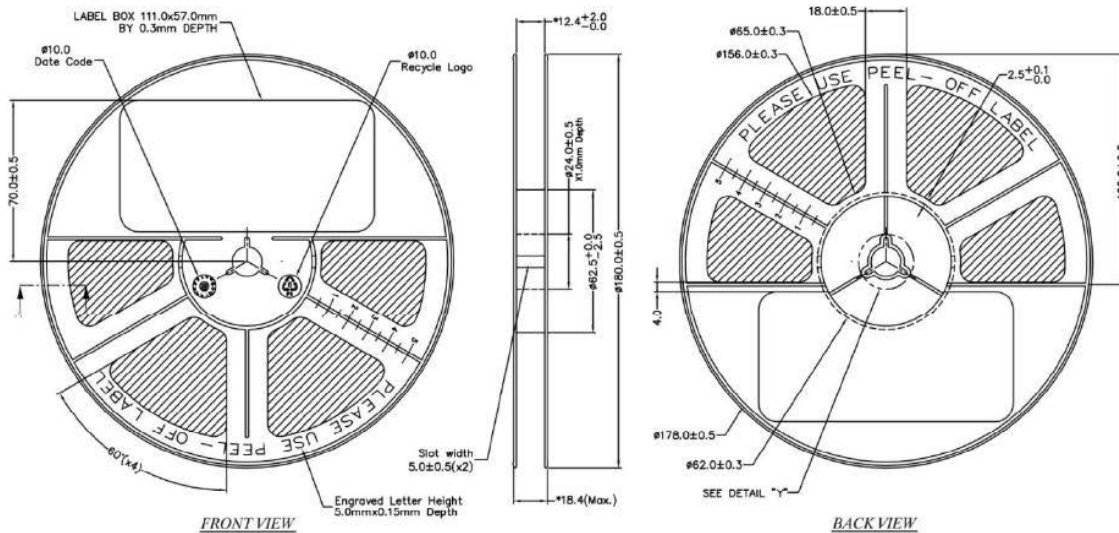

Figure 6: Reel Dimensions



Product Ordering Information

Ordering Part Number	Product Description	Package	Delivery Form
AEAT-9955-100	18Bits Magnetic Encoder On-Off Axis Tape Reel 1000	QFN 32 leads, 5 mm × 5 mm	Tape & Reel
AEAT-9955-102	18Bits Magnetic Encoder On-Off Axis Tape Reel 100	QFN 32 leads, 5 mm × 5 mm	Tape & Reel
AEAT-9955-Q32	18Bits Magnetic Encoder On-Off Axis	QFN 32 leads, 5 mm × 5 mm	Tube

Broadcom, the pulse logo, Connecting everything, Avago Technologies, Avago, and the A logo are among the trademarks of Broadcom and/or its affiliates in the United States, certain other countries, and/or the EU.

Copyright © 2021 Broadcom. All Rights Reserved.

The term “Broadcom” refers to Broadcom Inc. and/or its subsidiaries. For more information, please visit www.broadcom.com.

Broadcom reserves the right to make changes without further notice to any products or data herein to improve reliability, function, or design. Information furnished by Broadcom is believed to be accurate and reliable. However, Broadcom does not assume any liability arising out of the application or use of this information, nor the application or use of any product or circuit described herein, neither does it convey any license under its patent rights nor the rights of others.