

### FEATURES

- RoHS compliant
- Maxim MAX250/MAX251 compatible
- Isolation to 4kVrms
- Industry-standard pinout
- Surface mount option
- UL 94 V-0 package materials
- Low profile
- Toroidal construction
- Fully encapsulated
- Industrial temperature range

### DESCRIPTION

The 78250 series of converter transformers are specifically designed for use with Maxim chipsets to provide isolated RS232 interfaces. Carefully controlled turns ratios ensure consistent performance whilst a toroidal construction minimises EMI.

### Surface-mount parts

The surface-mount (M suffix) products are not recommended for new designs. For existing designs, however, Murata Power Solutions will continue to manufacture and fully support these parts.

For recommended alternatives please refer to the 78250J Series datasheet.



### CHARACTERISTICS 78250C/78250MC

Parameter	Conditions	Min.	Typ.	Max.	Units
Primary Inductance, $L_p$	10kHz, 100mV	1.0	2.0	2.5	mH
Leakage Inductance, $L_L$	100kHz, 100mV		2.0	3.0	$\mu$ H
Interwinding Capacitance, $C_{ww}$	100kHz, 100mV		69	90	pF
Primary D.C. Resistance, $R_{dc}$	<0.1VDC		1.0	2.0	$\Omega$
Volt-time Product, Et	Pins1/2 or 2/3	50			V $\mu$ s

### CHARACTERISTICS 78250VC/78250MVC

Parameter	Conditions	Min.	Typ.	Max.	Units
Primary Inductance, $L_p$	10kHz, 100mV	1.0	2.0	2.5	mH
Leakage Inductance, $L_L$	100kHz, 100mV		35	40	$\mu$ H
Interwinding Capacitance, $C_{ww}$	100kHz, 100mV		9	12	pF
Primary D.C. Resistance, $R_{dc}$	<0.1VDC		1.4	1.8	$\Omega$
Volt-time Product, Et	Pins1/2 or 2/3	50			V $\mu$ s

### ORDER CODE DETAILS

Order Code	Package Type	Packaging Type	Quantity
<b>78250C / 78250VC</b>	6 Pin DIL	Tube	50
<b>78250MC / 78250MVC</b>	6 Pin SM	Tube	50
<b>78250MC-R / 78250MVC-R</b>	6 Pin SM	Tape & Reel	500

### ABSOLUTE MAXIMUM RATINGS

Operating free air temperature range	-40°C to 85°C
Storage temperature range	-50°C to 125°C
Lead temperature 1.5mm from case for 10 seconds	300°C
Peak current, $I_{pk}$	300mA
Isolation voltage 78250(M)C (flash tested for 1 second)	1.5kVrms
Isolation voltage 78250(M)VC (flash tested for 1 second)	4.0kVrms

All specifications typical at  $T_A = -25^\circ\text{C}$

### TECHNICAL NOTES

#### ISOLATION VOLTAGE

'Hi Pot Test', 'Flash Tested', 'Withstand Voltage', 'Proof Voltage', 'Dielectric Withstand Voltage' & 'Isolation Test Voltage' are all terms that relate to the same thing, a test voltage, applied for a specified time, across a component designed to provide electrical isolation, to verify the integrity of that isolation.

All products in this series are 100% production tested at their stated isolation voltage.

A question commonly asked is, "What is the continuous voltage that can be applied across the part in normal operation?"

For a part holding no specific agency approvals both input and output should normally be maintained within SELV limits i.e. less than 42.4V peak, or 60VDC. The isolation test voltage represents a measure of immunity to transient voltages and the part should never be used as an element of a safety isolation system. The part could be expected to function correctly with several hundred volts offset applied continuously across the isolation barrier; but then the circuitry on both sides of the barrier must be regarded as operating at an unsafe voltage and further isolation/insulation systems must form a barrier between these circuits and any user-accessible circuitry according to safety standard requirements.

#### REPEATED HIGH-VOLTAGE ISOLATION TESTING

It is well known that repeated high-voltage isolation testing of a barrier component can actually degrade isolation capability, to a lesser or greater degree depending on materials, construction and environment. This series has toroidal isolation transformers, with no additional insulation between primary and secondary windings of enamelled wire. While parts can be expected to withstand several times the stated test voltage, the isolation capability does depend on the wire insulation. Any material, including this enamel (typically polyurethane) is susceptible to eventual chemical degradation when subject to very high applied voltages thus implying that the number of tests should be strictly limited. We therefore strongly advise against repeated high voltage isolation testing, but if it is absolutely required, that the voltage be reduced by 20% from specified test voltage.

This consideration equally applies to agency recognised parts rated for better than functional isolation where the wire enamel insulation is always supplemented by a further insulation system of physical spacing or barriers.

## PACKAGE SPECIFICATIONS

### MECHANICAL DIMENSIONS

#### 6 Pin DIL

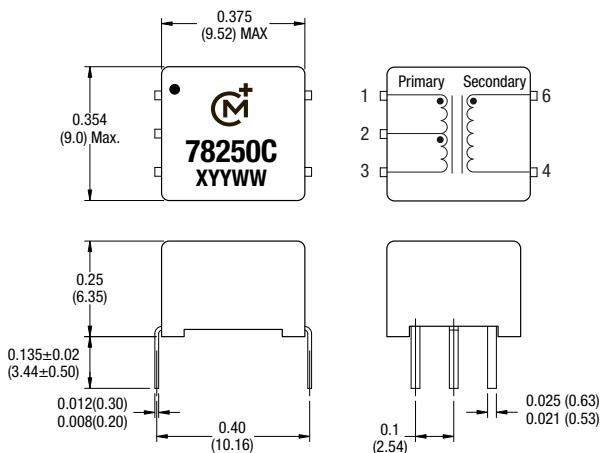

#### 6 Pin SM

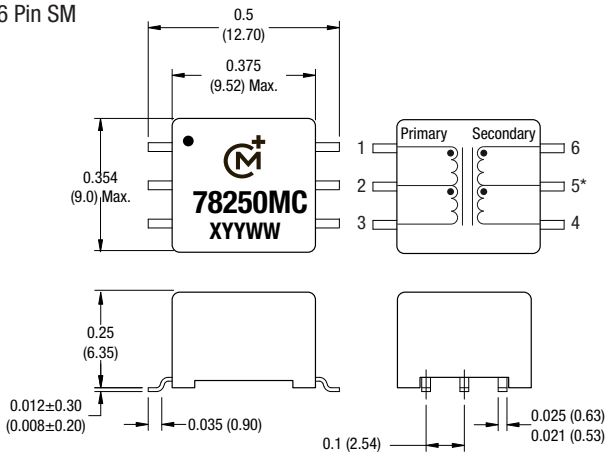

Unless otherwise stated all dimensions in inches (mm) ±0.01 (0.25).  
All pins on a 0.1 (2.54) pitch and within ±0.01 (0.25) of true position.  
\*Pin 5 is connected to secondary center tap. Package Weight 1.0g TYP.

### RECOMMENDED FOOTPRINT DETAILS

#### 6 Pin DIL

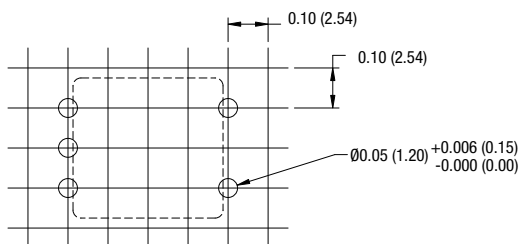

#### 6 Pin SM

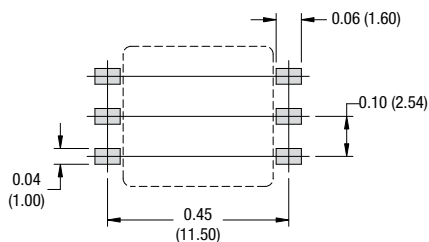

Unless otherwise stated all dimensions in inches (mm) ±0.01 (0.25). All pins on a 0.1 (2.54) pitch and within ±0.01 (0.25) of true position.

### TUBE OUTLINE DIMENSIONS

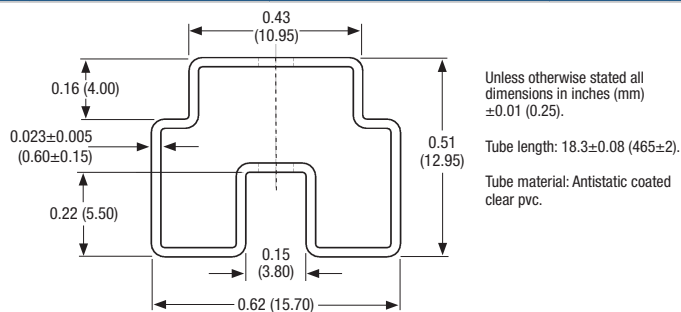

### SOLDERING INFORMATION<sup>1</sup>

Pin finish	Matte tin
Peak wave solder temperature	300°C for 10 seconds
Peak reflow temperature	220°C <sup>2</sup>

- For further information, please visit [www.murata-ps.com/rohs](http://www.murata-ps.com/rohs)
- For high temperature reflow parts see 78250J Series.

## TAPE & REEL SPECIFICATIONS

### REEL OUTLINE DIMENSIONS

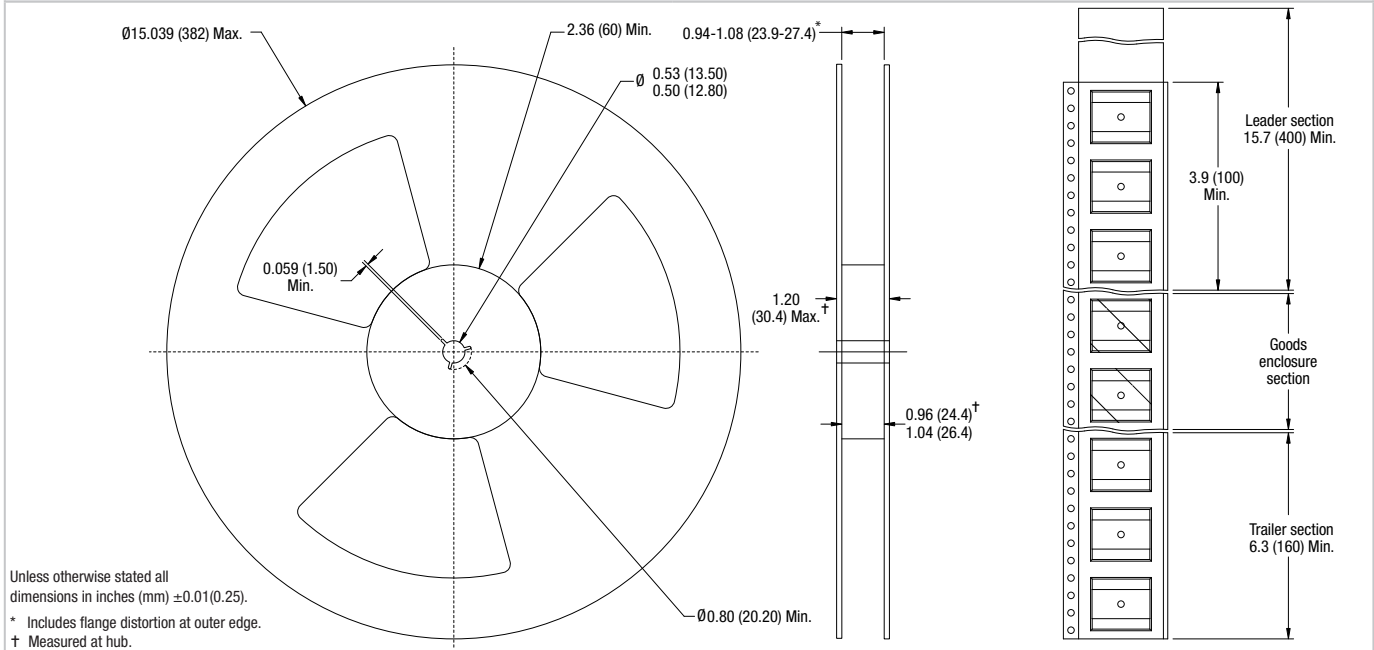

### TAPE OUTLINE DIMENSIONS

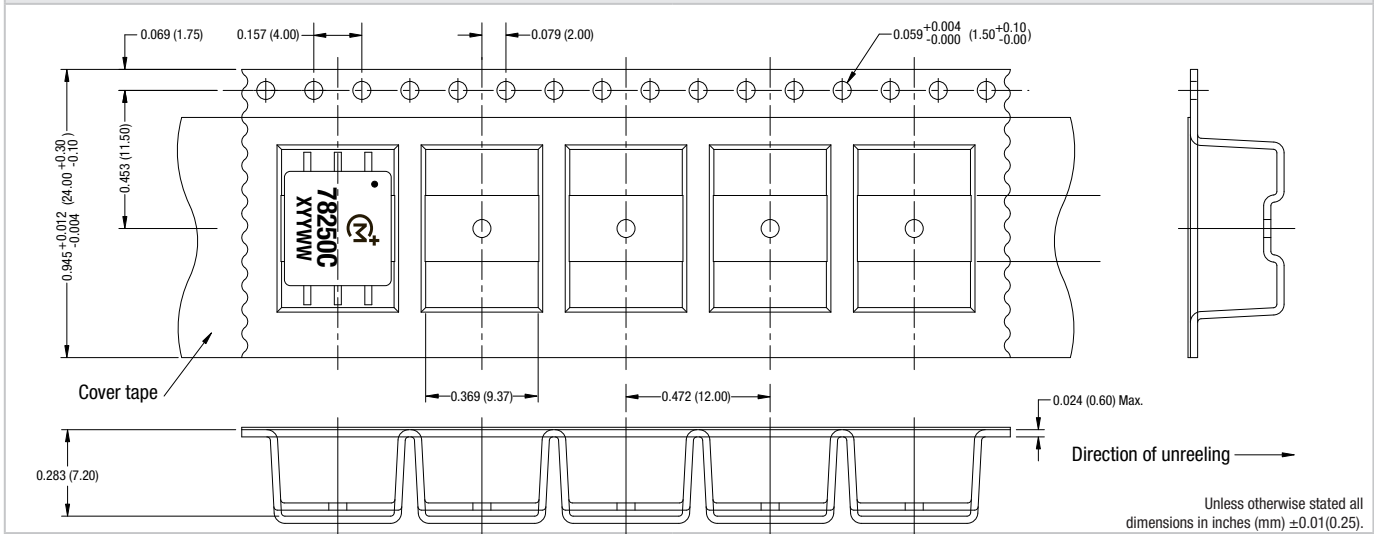

**DISCLAIMER**

Unless otherwise stated in the datasheet, all products are designed for standard commercial and industrial applications and NOT for safety-critical and/or life-critical applications.

Particularly for safety-critical and/or life-critical applications, i.e. applications that may directly endanger or cause the loss of life, inflict bodily harm and/or loss or severe damage to equipment/property, and severely harm the environment, a prior explicit written approval from Murata is strictly required. Any use of Murata standard products for any safety-critical, life-critical or any related applications without any prior explicit written approval from Murata shall be deemed unauthorised use.

These applications include but are not limited to:

- Aircraft equipment
- Aerospace equipment
- Undersea equipment
- Power plant control equipment
- Medical equipment
- Transportation equipment ( automobiles, trains, ships, etc.)
- Traffic signal equipment
- Disaster prevention / crime prevention equipment
- Data Processing equipment

Murata makes no express or implied warranty, representation, or guarantee of suitability, fitness for any particular use/purpose and/or compatibility with any application or device of the buyer, nor does Murata assume any liability whatsoever arising out of unauthorised use of any Murata product for the application of the buyer. The suitability, fitness for any particular use/purpose and/or compatibility of Murata product with any application or device of the buyer remain to be the responsibility and liability of the buyer.

Buyer represents and agrees that it has all the necessary expertise to create and implement safeguards that anticipate dangerous consequences of failures, monitor failures and their consequences, lessen the likelihood of failures that might cause harm, and take appropriate remedial actions. Buyer will fully indemnify and hold Murata, its affiliated companies, and its representatives harmless against any damages arising out of unauthorised use of any Murata products in any safety-critical and/or life-critical applications.

Remark: Murata in this section refers to Murata Manufacturing Company and its affiliated companies worldwide including, but not limited to, Murata Power Solutions.



**This product is subject to the following [operating requirements](#) and the [Life and Safety Critical Application Sales Policy](#):**

**Refer to: <https://www.murata.com/en-eu/products/power/requirements>**

Murata Power Solutions (Milton Keynes) Ltd. makes no representation that the use of its products in the circuits described herein, or the use of other technical information contained herein, will not infringe upon existing or future patent rights. The descriptions contained herein do not imply the granting of licenses to make, use, or sell equipment constructed in accordance therewith. Specifications are subject to change without notice.

© 2021 Murata Power Solutions (Milton Keynes) Ltd