

Verpackt im Gurt nach DIN IEC 60286-3  
 Tape on Reel Packaging according to DIN IEC 60286-3  
 Verpackungseinheit: 280 Stück  
 Packaging unit: 280 pcs

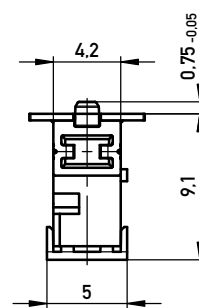

Abspulrichtung - Reel off Direction →

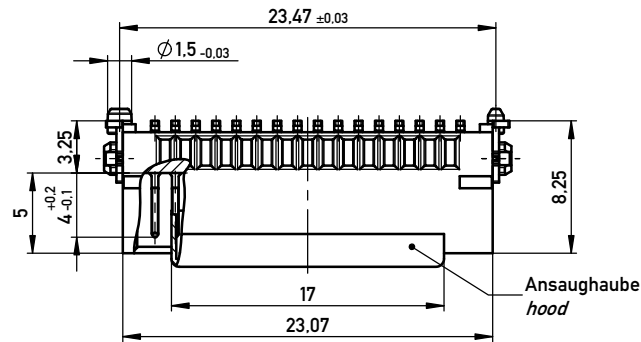
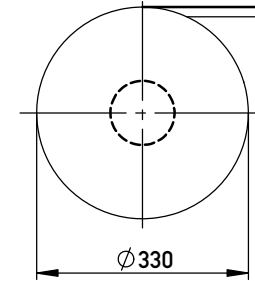
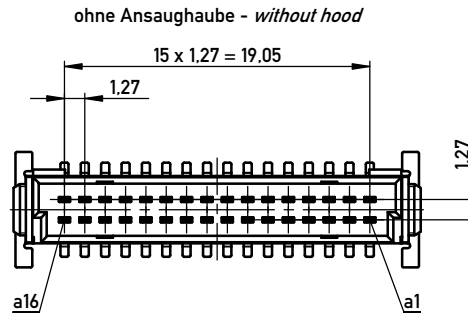
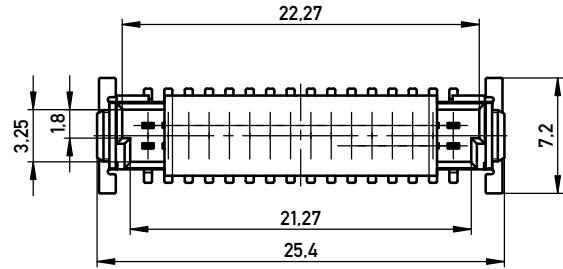
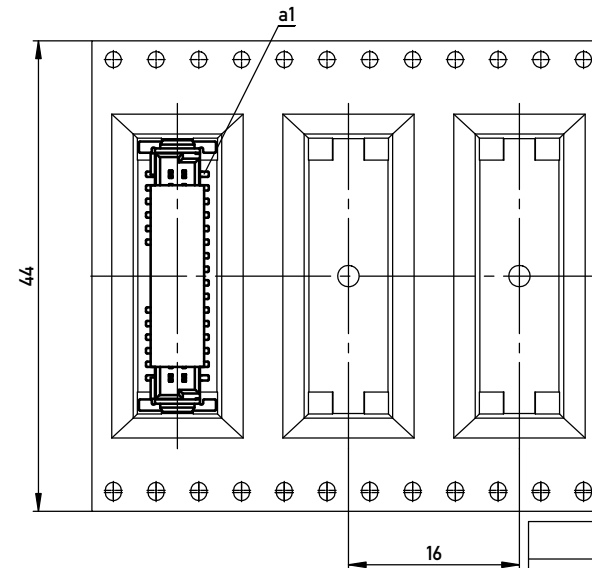

Leiterplatten-Layout Vorschlag für SMT  
 PCB-Layout Proposal for SMT

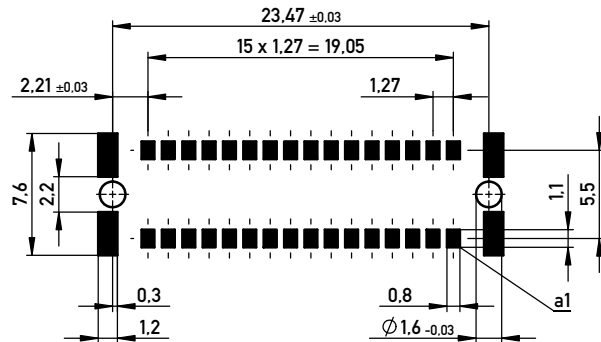

Anforderungsstufe 1  
 Performance Level 1

Kontaktbereich vergoldet  
 Mating Area gold plating

Anschlussbereich verzinkt 4-6 µm  
 Terminal Area 4-6 µm tin plating

Koplanarität der Anschlüsse ≤ 0,1 mm  
 Coplanarity Area of Termination ≤ 0,1 mm

BA 8-03 - Standard Bauhöhe

type 8-03 - Standard Assembly Height

Information:		Tolerances	Scale 3:1
All rights reserved. Only for Information. To ensure that this is the latest version of this drawing, please contact one of the ERNI companies before using.		 All Dimensions in mm	Designation
Subject to modification without prior notice. Drawing will not be updated.		www.ERNI.com	<b>Messertl. SMC-Q 32-SMD-BA8-03</b> <b>Male SMC-Q 32-SMD-type8-03</b>
e	26.06.2015	254538	
Index	Date	Class SMCQ	
		I A3	

Copyright by ERNI GmbH  
 Proprietary notice pursuant to ISO 9006 to be observed.

# Mouser Electronics

Authorized Distributor

Click to View Pricing, Inventory, Delivery & Lifecycle Information:

[TE Connectivity:](#)

[254538](#) [254538-E](#)