

QT-Brightek PLCC Series

3528 PLCC2 IR LED

Part No.: QBLP670-IR2

Product: QBLP670-IR2	Date: May 01, 2015	Page 1 of 9
	Version# 1.0	

Table of Contents:

Introduction	3
Electrical / Optical Characteristic (Ta=25 °C)	4
Absolute Maximum Rating	4
Characteristic Curves.....	5
Solder Profile & Footprint.....	6
Packing	7
Labeling	8
Ordering Information	8
Revision History	9
Disclaimer	9

Product: QBLP670-IR2	Date: May 01, 2015	Page 2 of 9
	Version# 1.0	

Introduction

Feature:

- Water clear lens
- Package in tape and reel
- AlGaAs technology
- Viewing Angle = 120 deg

Description:

These ultra bright reflector type PLCC2 LEDs have a height profile of 1.90mm. Combination of high brightness output and robust package, these LEDs are ideal for architecture lighting, status indication, and industrial equipment lighting applications.

Application:

- Infrared Sensor
- Optoelectronic Switch
- Smoke detector
- Drive sensor

Certification & Compliance:

- TS16949
- ISO9001
- RoHS Compliant



Dimension:

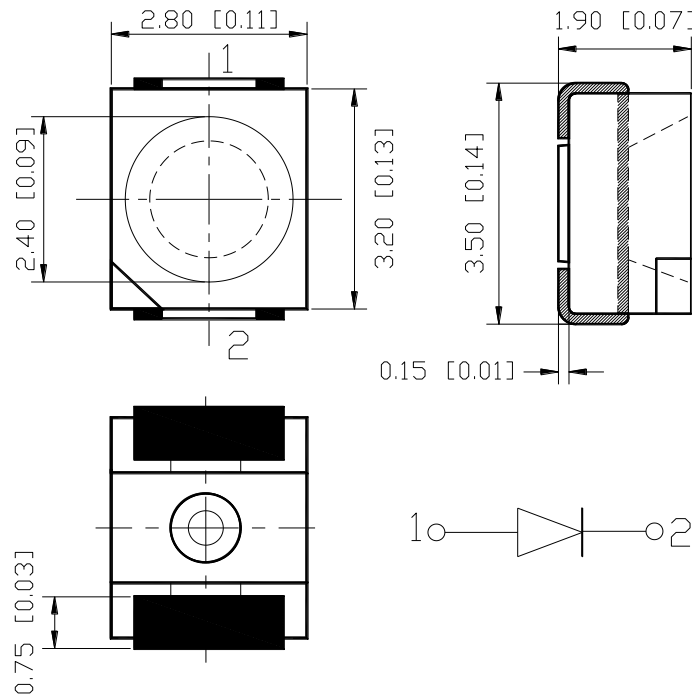

Units: mm / tolerance = +/-0.2mm

Product: QBLP670-IR2	Date: May 01, 2015	Page 3 of 9
	Version# 1.0	

Electrical / Optical Characteristic (Ta=25 °C)

Product	Color	I _F (mA)	V _F (V)		λ _P (nm)			I _e (mW/sr)		
			Typ.	Max.	Min.	Typ.	Max.	Min.	Typ.	Max.
QBLP670-IR2	Infrared	20	1.4	1.6	-	880	-	0.25	0.6	1.25
		50	1.7	1.8				0.6	1.75	3.1

Absolute Maximum Rating

Material	P _d (mW)	I _F (mA)	I _{FP} (A)*	V _R (V)	T _{OP} (°C)	T _{ST} (°C)	T _{SO L} (°C)**
AlGaAs	90	100	1	5	-40 ~ +80	-40 ~ +85	260

*Duty cycle=1%, Pulse width 100us

**IR Reflow for no more than 10 sec @ 260 °C

Characteristic Curves

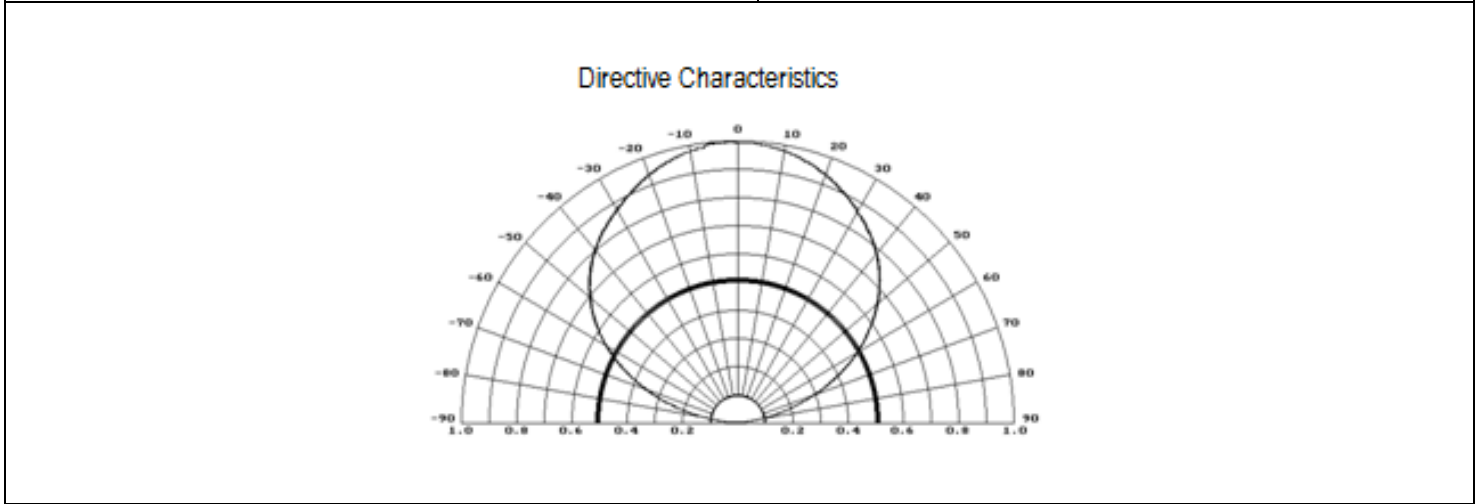
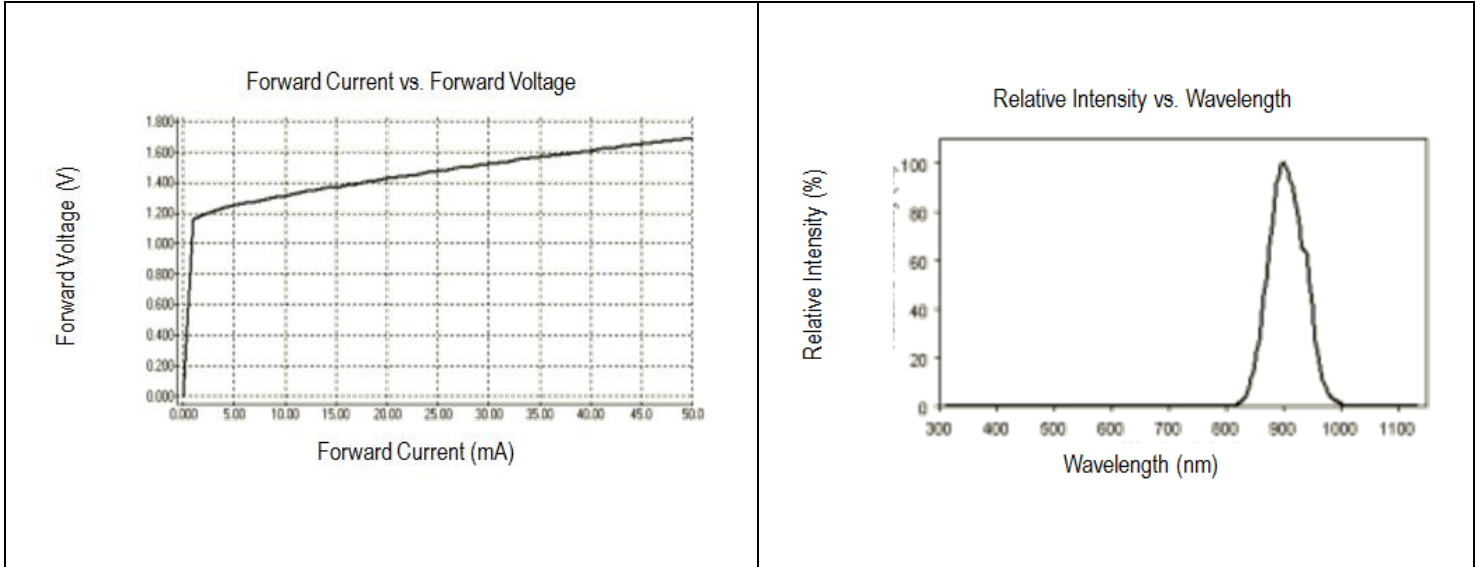

Solder Profile & Footprint

- Recommended tin solder specifications: melting temperature in the range of 178~192 °C
- The recommended reflow soldering profile is as follows (temperatures indicated are as measured on the surface of the LED resin):

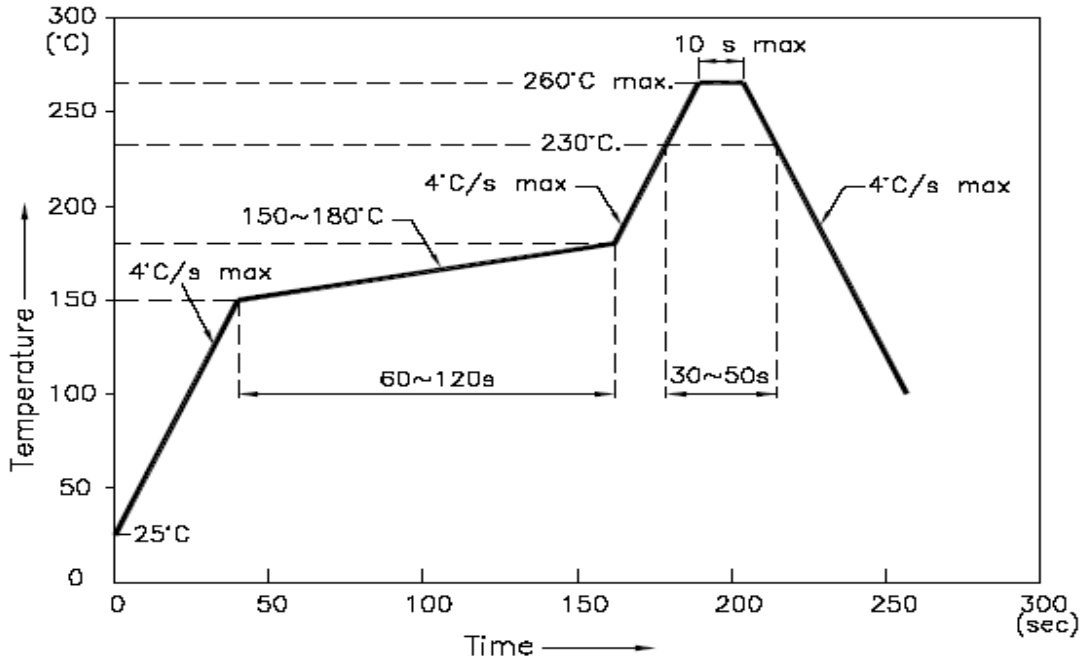

Recommended Pad Layout

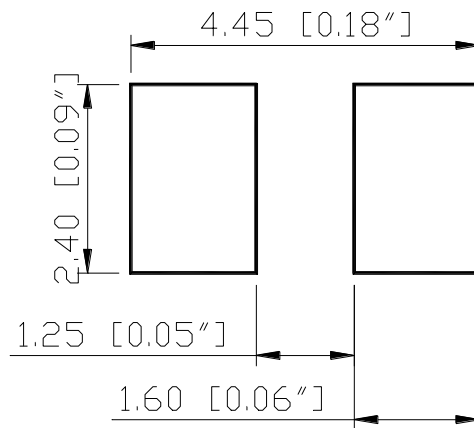

Units: mm

Tolerance: ± 0.2mm

Packing

Reel Dimension:

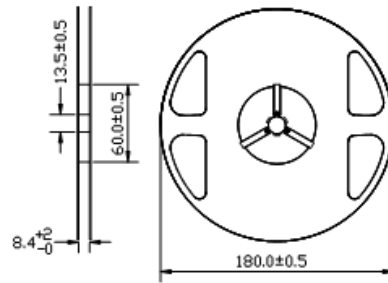

Unit: mm

Tape Dimension:

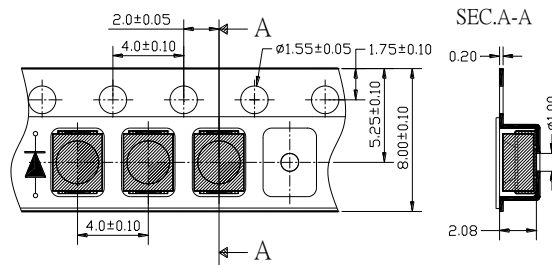

Unit: mm

Arrangement of Tape:

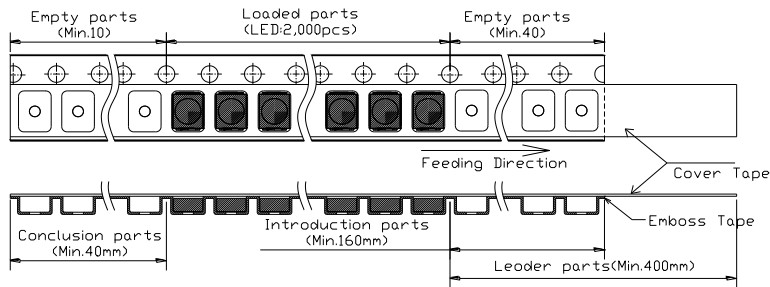

Packaging Specification:

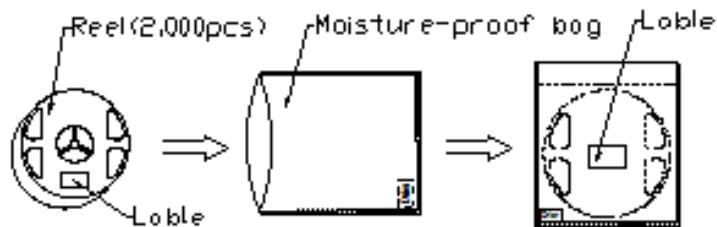

Product: QBLP670-IR2	Date: May 01, 2015	Page 7 of 9
	Version# 1.0	

Labeling

Part No: _____

Customer P/N: _____

Item: _____

Q'ty: _____

Vf: _____

Iv: _____

WI: _____

Date: _____

Made in China**Ordering Information**

Part #	Orderable Part #	Spec Range	Quantity per reel
QBLP670-IR2	QBLP670-IR2	Ie=0.6mW/sr typ. @ I _F =20mA / λ _P =940nm typ.	2,000 units

Product: QBLP670-IR2	Date: May 01, 2015	Page 8 of 9
	Version# 1.0	

Revision History

Description:	Revision #	Revision Date
New Release of QBLP670-IR2	V1.0	05/01/2015

Disclaimer

QT-BRIGHTTEK reserves the right to make changes without further notice to any products herein to improve reliability, function or design. QT-BRIGHTTEK does not assume any liability arising out of the application or use of any product or circuit described herein; neither does it convey any license under its patent rights, nor the rights of others.

Life Support Policy

QT-BRIGHTTEK's products are not authorized for use as critical components in life support devices or systems without the express written approval of QT-BRIGHTTEK. As used herein:

1. Life support devices or systems are devices or systems which, (a) are intended for surgical implant into the body, or (b) support or sustain life, and (c) whose failure to perform when properly used in accordance with instructions for use provided in the labeling, can be reasonably expected to result in a significant injury of the user.
2. A critical component in any component of a life support device or system whose failure to perform can be reasonably expected to cause the failure of the life support device or system, or to affect its safety or effectiveness.

Product: QBLP670-IR2	Date: May 01, 2015	Page 9 of 9
	Version# 1.0	