

TLE9255W

HS CAN Transceiver with Partial Networking



1 Overview

Features

- Fully compliant to ISO 11898-2 (2016)
- HS CAN standard data rates up to 1MBit/s
- CAN FD data rates up to 5 MBit/s
- Wide common mode range for electromagnetic immunity (EMI)
- Very low electromagnetic emission (EME)
- Excellent ESD robustness, ± 10 kV according to IEC 61000-4-2
- Independent supply concept on V_{CC} and V_{BAT} pins
- Fail safe features
 - TxD-timeout
 - overtemperature shutdown
 - overtemperature warning
- Extended supply range on V_{CC} and V_{IO} supply
- CAN short circuit proof to ground, battery and V_{CC}
- Overtemperature protection
- Advanced bus biasing according to ISO 11898-2 (2016)
- Wake filter time $0.5\mu\text{s} < t_{\text{Filter}} < 1.8\mu\text{s}$ meeting worldwide OEM requirements
- Wake-up pattern (WUP) detection in all low-power modes
- Wake-up frame (WUF) detection according to ISO 11898-2 (2016)
- Wake-up frame detection with CAN FD tolerant feature
- Local wake-up input
- SPI clock frequency up to 4 MHz
- Green Product (RoHS compliant)

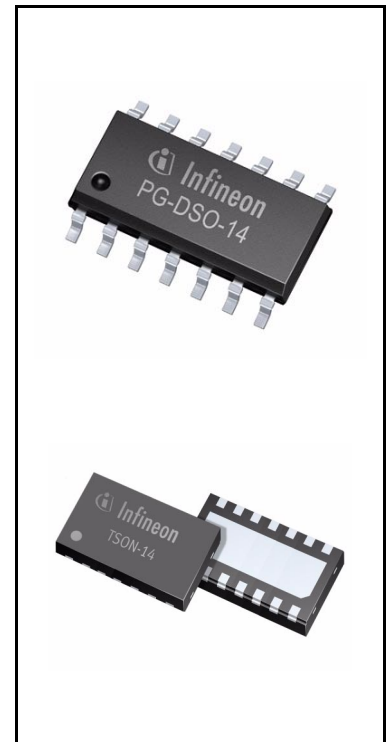

Potential applications

- HS CAN networks in automotive applications
- HS CAN networks in industrial applications

Product validation

Qualified for automotive applications. Product validation according to AEC-Q100.

Overview

Description

As an interface between the physical bus layer and the CAN protocol controller, the TLE9255W drives the signals to the bus and protects the microcontroller from interference generated within the network. Based on the high symmetry of the CANH and CANL signals, the TLE9255W provides a very low level of electromagnetic emission within a wide frequency range, allowing the operation of the TLE9255W without a common mode choke in automotive and industrial applications.

The TLE9255W is enclosed in an RoHS compliant PG-DSO-14 or PG-TSON-14 package and fulfills the requirements of the ISO11898-2 (2016).

The TLE9255W is part of the Infineon standard HS CAN transceiver family and provides beside CAN partial networking functions also a CAN FD capability up to 5 MBit/s in HS CAN networks. Configured as a partial networking HS CAN transceiver the TLE9255W can drive and receive CAN FD messages. It can also be used to block the payload of CAN FD messages. This CAN FD tolerant feature allows the usage of microcontrollers in CAN FD networks, which are not CAN FD capable.

The SPI of TLE9255W controls the setup of the wake-up messages and the status message generated by the internal state machine. Most of the functions, including wake-up functions, INH output control, mode control, undervoltage control are configurable by the SPI. This allows a very flexible usage of the TLE9255W in different applications.

The two non-low power modes (Normal-operating Mode and Receive-only Mode) and the two low power modes (Sleep Mode and Stand-by Mode) provide minimum current consumption based on the required functionality.

In Sleep Mode the TLE9255W can detect a wake-up pattern (WUP) on the HS CAN and then change the mode of operation accordingly; even at a quiescent current below 26 μ A over the full temperature range.

In Selective-wake Sub-mode the TLE9255W monitors the CAN messages on the HS CAN bus. If the TLE9255W detects a matching wake-up frame, then it triggers a mode change. The TLE9255W monitors wake-up identifiers up to 29 bit as well as up to 64 bit wide data. The internal protocol handler counts all bus errors. The SPI indicates failures, error counter overflow and synchronization failures to the microcontroller.

The unique power-supply management allows the application to use the TLE9255W without the battery supply V_{BAT} connected. In this case the TLE9255W is supplied over the V_{CC} pin. The V_{IO} voltage reference supports 3.3 V and 5 V supplied microcontrollers.

Based on Infineon Smart Power Technology (SPT), the TLE9255W provides excellent immunity together with a very high electromagnetic immunity (EMI). The TLE9255W and the Infineon SPT are AEC qualified and tailored to withstand the harsh conditions of the automotive environment.

Type	Package	Marking
TLE9255WSK	PG-DSO-14	9255W
TLE9255WLC	PG-TSON-14	9255W

Table of Contents

1	Overview	1
2	Block Diagram	6
3	Pin Configuration	7
3.1	Pin Assignment	7
3.2	Pin Definitions	7
4	High Speed CAN Functional Description	9
4.1	High Speed CAN Physical Layer	9
5	Modes of Operation	11
5.1	Normal-operating Mode	13
5.2	Receive-only Mode	14
5.3	Stand-by Mode	15
5.4	Sleep Mode	17
5.4.1	Sleep WUP Sub-Mode	19
5.4.2	Selective Wake Sub-Mode	20
5.4.3	Selective Sleep Sub-Mode	22
5.5	Power On Reset	23
5.6	Automatic Bus Voltage Biasing	25
5.7	Wake-up event	26
5.7.1	Wake-up pattern (WUP)	26
5.7.2	Wake-up frame (WUF)	27
5.7.3	Local Wake-up (LWU)	28
5.8	RxD pin wake-up behavior	29
5.8.1	RxD permanent “low”	29
5.8.2	RxD Toggle	30
6	Fail Safe Functions	31
6.1	Short Circuit Protection	31
6.2	Undervoltage detection	31
6.2.1	Undervoltage detection on V_{BAT}	31
6.2.2	Short-term Undervoltage detection on V_{CC}	33
6.2.3	Long-term undervoltage detection on V_{CC}	34
6.2.4	Short-term Undervoltage detection on V_{IO}	34
6.2.5	Long-term Undervoltage detection on V_{IO}	36
6.3	Unconnected Logic Pins	37
6.4	TxD Time-out Function	38
6.5	Overtemperature Protection	39
6.6	Delay Time for Mode Change	39
7	CAN Partial Networking	40
7.1	Wake-up frame evaluation	40
7.1.1	Wake-up frame identifier evaluation	40
7.1.2	DLC and data field evaluation	41
7.2	Activation of Selective Wake	42
7.3	Frame Error Counter	43
7.4	Selective Wake Configuration Error	43

7.5	CAN Flexible Data Rate (CAN FD) Tolerant Feature	44
7.6	Selective wake SPI flags	45
7.6.1	SysErr Flag	45
7.6.2	SYNC Flag	45
7.6.3	CANTO Flag	46
7.6.4	CANSIL Flag	46
7.6.5	SWK_ACTIVE Flag	46
7.6.6	CFG_VAL Flag	46
8	Serial Peripheral Interface	47
8.1	SPI command format	48
8.2	Control and Status Register	49
8.3	Status Information Field	50
8.4	SPI Failure	50
8.5	Invalid SPI Command	50
8.6	CSN Timeout	51
8.7	SPI Register	51
8.7.1	Mode Control Register	53
8.7.2	Selective Wake Control Register	57
8.7.3	Status Register	64
9	General Product Characteristics	68
9.1	Absolute Maximum Ratings	68
9.2	Functional Range	70
9.3	Thermal Resistance	71
10	Electrical Characteristics	72
10.1	General Timing Parameter	72
10.2	Power Supply Interface	72
10.2.1	Current Consumption	72
10.2.2	Undervoltage Detection	76
10.2.3	INH Output	77
10.3	CAN Controller Interface	77
10.4	Transmitter and Receiver	79
10.4.1	Transmitter	79
10.4.2	Receiver	81
10.4.3	Dynamic Transceiver Parameter	82
10.5	Selective Wake Parameter	86
10.5.1	General Timings	86
10.5.2	CAN FD Tolerance	87
10.6	Wake-Up	88
10.6.1	General Timings	88
10.6.2	WUP detection Characteristics	89
10.6.3	Local Wake-Up	90
10.7	SPI	90
11	Application Information	93
11.1	ESD Robustness according to IEC 61000-4-2	93
11.2	Application Example	94
11.3	Voltage Adaption to the Microcontroller Supply	95

11.4	Further Application Information	95
12	Package Outlines	96
13	Revision History	99

Block Diagram

2 Block Diagram

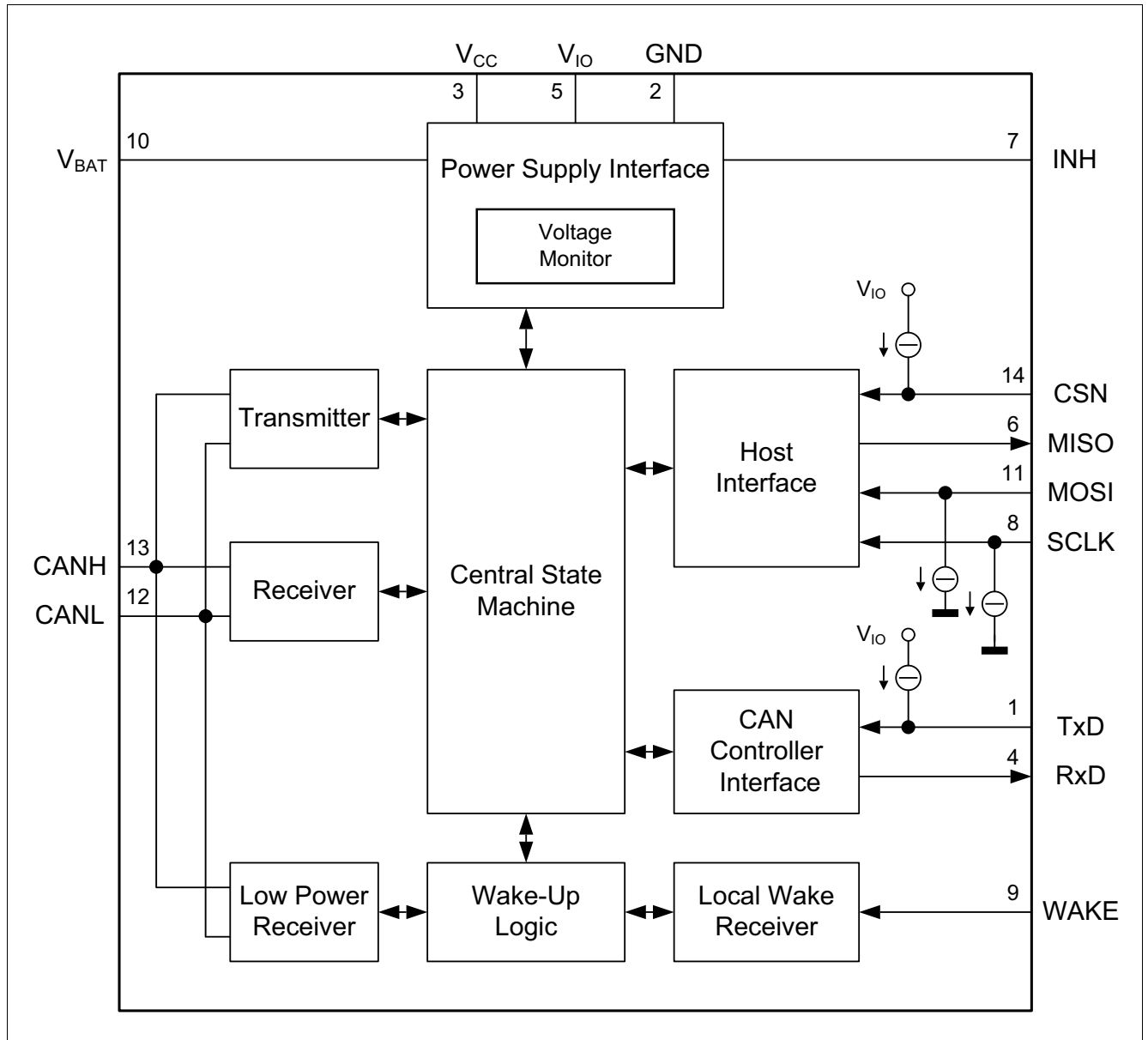

Figure 1 Block Diagram

Pin Configuration

3 Pin Configuration

3.1 Pin Assignment

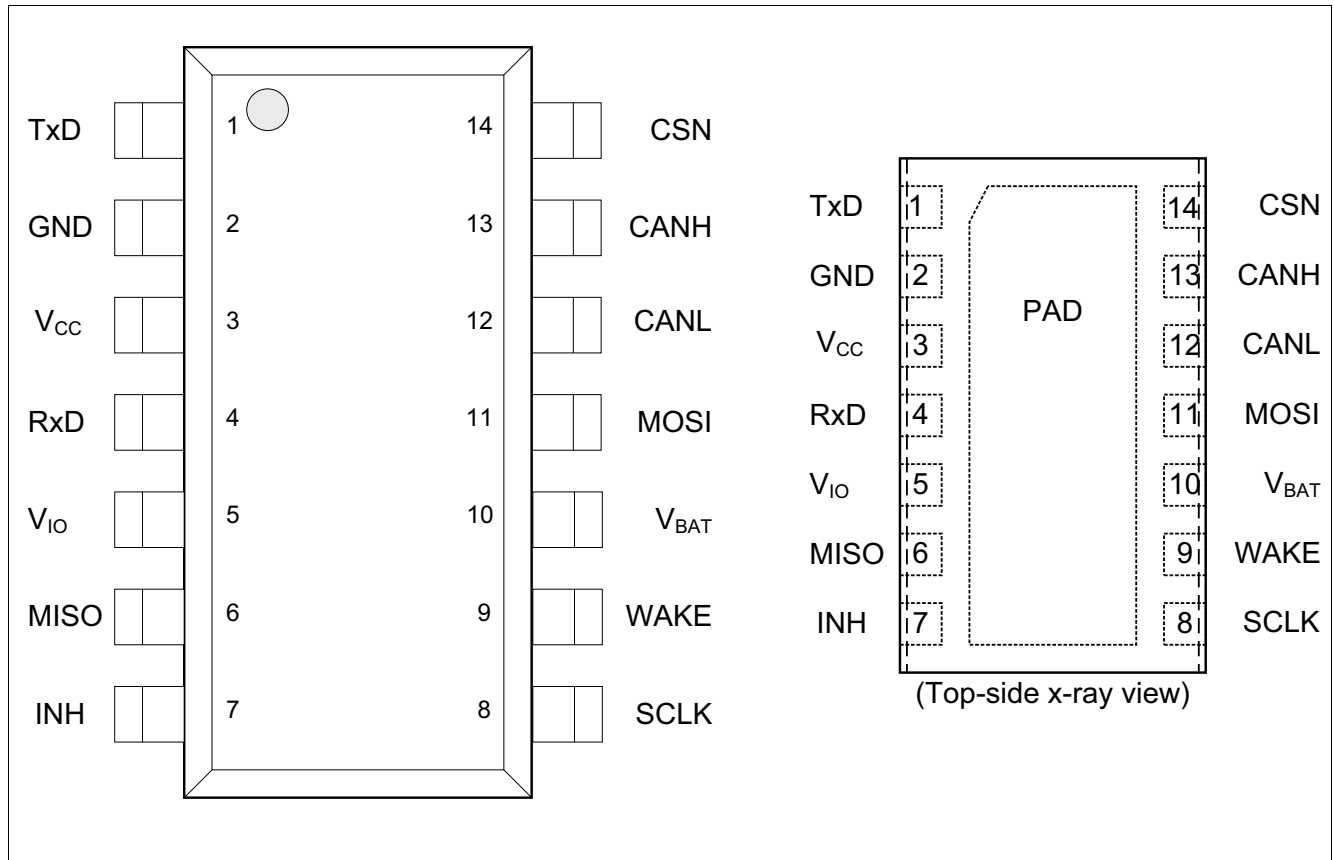

Figure 2 Pin configuration for PG-DSO-14 and PG-TSON-14

3.2 Pin Definitions

Table 1 Pin definitions and functions

Pin	Symbol	Function
1	TxD	Transmit Data Input; integrated pull-up current source to V_{IO} , "low" to drive a dominant signal on CANH and CANL
2	GND	Ground.
3	V_{CC}	Transmitter Supply Voltage; 100 nF decoupling capacitor to GND is recommended

Pin Configuration

Table 1 Pin definitions and functions (cont'd)

Pin	Symbol	Function
4	RxD	Receive Data Output; “low” while a dominant signal is on the HS CAN bus, output voltage adapted to the voltage on the V_{IO} level shift input
5	V_{IO}	Level Shift Input; reference voltage for the digital input and output pins, 100 nF decoupling capacitor to GND is recommended
6	MISO	SPI Serial Data Output; tri-state while CSN is “high”
7	INH	Inhibit Output; open drain output to control external circuitry
8	SCLK	SPI Clock Input; integrated pull-down current source to GND
9	WAKE	Wake-up Input; local wake-up input, terminated against GND and V_{BAT} , wake-up input sensitive to signal changes in both directions
10	V_{BAT}	Battery Supply Voltage; 100 nF decoupling capacitor to GND is recommended
11	MOSI	SPI Serial Data Input; integrated pull-down current source to GND
12	CANL	Low-level HS CAN Bus Line
13	CANH	High-level HS CAN Bus Line
14	CSN	SPI Chip Select Not Input; integrated pull-up current source to V_{IO}
PAD	-	Connect to PCB heat sink area. Do not connect to other potential than GND.

High Speed CAN Functional Description

4 High Speed CAN Functional Description

High speed CAN (HS CAN) is a serial bus system that connects microcontrollers, sensors and actuators for real-time control applications. ISO 11898-2 (2016) describes the use of the Controller Area Network (CAN) within road vehicles. According to the 7-layer OSI reference model the physical layer of a HS CAN bus system specifies the data transmission from one CAN node to all other available CAN nodes within the network. The CAN transceiver is part of the physical layer. The physical layer specification of a CAN bus system includes all electrical specifications of a CAN network.

The TLE9255W supports:

- standard bus wake-up functionality
- CAN Partial Networking with selective wake-up functionality according to ISO 11898-2 (2016)
- CAN Flexible data rate (CAN FD) transmission up to 5 MBit/s

4.1 High Speed CAN Physical Layer

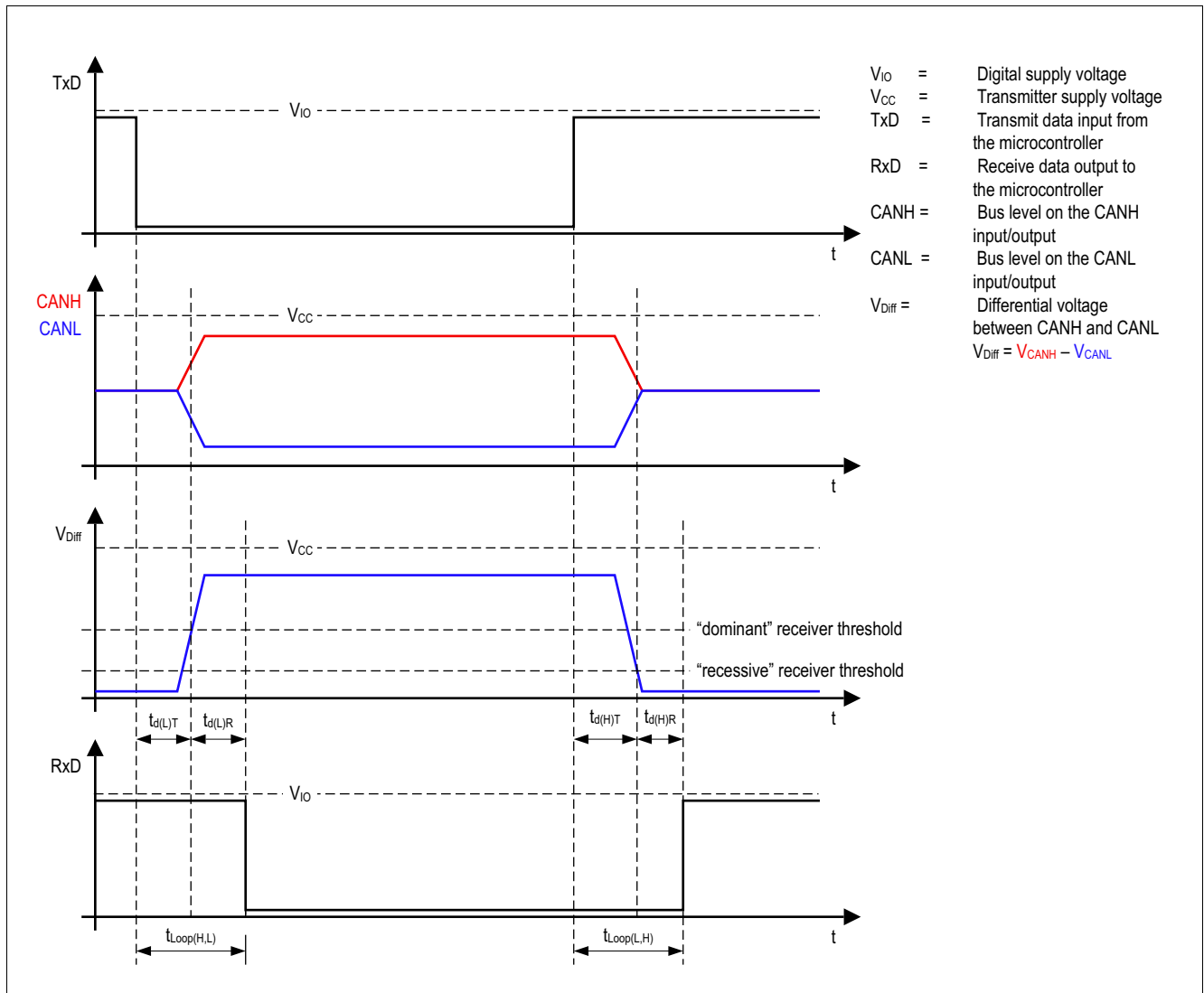

Figure 3 High speed CAN bus signals and logic signals

High Speed CAN Functional Description

The TLE9255W is a HS CAN transceiver operating as an interface between the CAN controller and the physical bus medium. A HS CAN network is a two wire, differential network which allows data transmission rates up to 5 MBit/s. HS CAN networks have two signal states on the CAN bus (see [Figure 3](#)):

- dominant
- recessive

The CANH and CANL pins are the interface to the CAN bus and operate both as an input and as an output. The RxD and TxD pins are the interface to the microcontroller. The TxD pin is the serial data input from the CAN controller. The RxD pin is the serial data output to the CAN controller. The HS CAN transceiver TLE9255W includes a receiver and a transmitter unit, allowing the transceiver to send data to the bus medium and monitoring the data from the bus medium at the same time (see [Figure 1](#)). The TLE9255W converts the serial data stream, which is available on the transmit data input TxD, to a differential output signal on the CAN bus, provided by the CANH and CANL pins. The receiver stage of the TLE9255W monitors the data on the CAN bus and converts it to a serial, single-ended signal on the RxD output pin. A “low” signal on the TxD pin creates a dominant signal on the CAN bus, followed by a “low” signal on the RxD pin (see [Figure 3](#)). The feature of broadcasting data to the CAN bus and listening to the data traffic on the CAN bus simultaneously is essential to support the bit-to-bit arbitration within CAN networks.

ISO 11898-2 (2016) defines the voltage levels for HS CAN transceivers. Whether a data bit is dominant or recessive depends on the voltage difference between the CANH and CANL pins:

$$V_{\text{Diff}} = V_{\text{CANH}} - V_{\text{CANL}}$$

To transmit a dominant signal to the CAN bus the amplitude of the differential signal V_{Diff} is ≥ 1.5 V. To receive a recessive signal from the CAN bus the amplitude of the differential V_{Diff} is ≤ 0.5 V.

Partially supplied High-Speed CAN networks have CAN bus nodes with different power supply conditions. Some nodes are connected to the common power supply, while other nodes are disconnected from the power supply and in power-down state. Regardless of whether the CAN bus subscriber is supplied or not, each subscriber connected to the common bus media must not interfere with the communication. The TLE9255W is designed to support Partially supplied networks. In power-down state, the receiver input resistors are switched off and the transceiver input has a high resistance.

For permanently supplied ECUs, the TLE9255W provides low power modes. In these low power modes, the current consumption of the TLE9255W is optimized to a minimum, while the TLE9255W can still recognize wake-up patterns or wake-up frames on the CAN bus and signal the wake-up event to the external microcontroller.

The voltage level on the digital input TxD and the digital output RxD is determined by the reference supply level at the V_{IO} pin. Depending on the voltage level at the V_{IO} pin, the signal levels on the logic pins (CSN, SCLK, MOSI, MISO, TxD and RxD) are compatible to microcontrollers having a 5 V or 3.3 V I/O supply. It is highly recommended that the digital power supply of V_{IO} of the transceiver is connected to the I/O power supply of the microcontroller; this is the way it is intended to be used (see [Figure 53](#)).

Modes of Operation

5 Modes of Operation

The TLE9255W supports four different Modes of operation (see **Figure 4**):

- Normal-operating Mode (**Chapter 5.1**)
- Receive-only Mode (**Chapter 5.2**)
- Stand-by Mode (**Chapter 5.3**)
- Sleep Mode (**Chapter 5.4**)

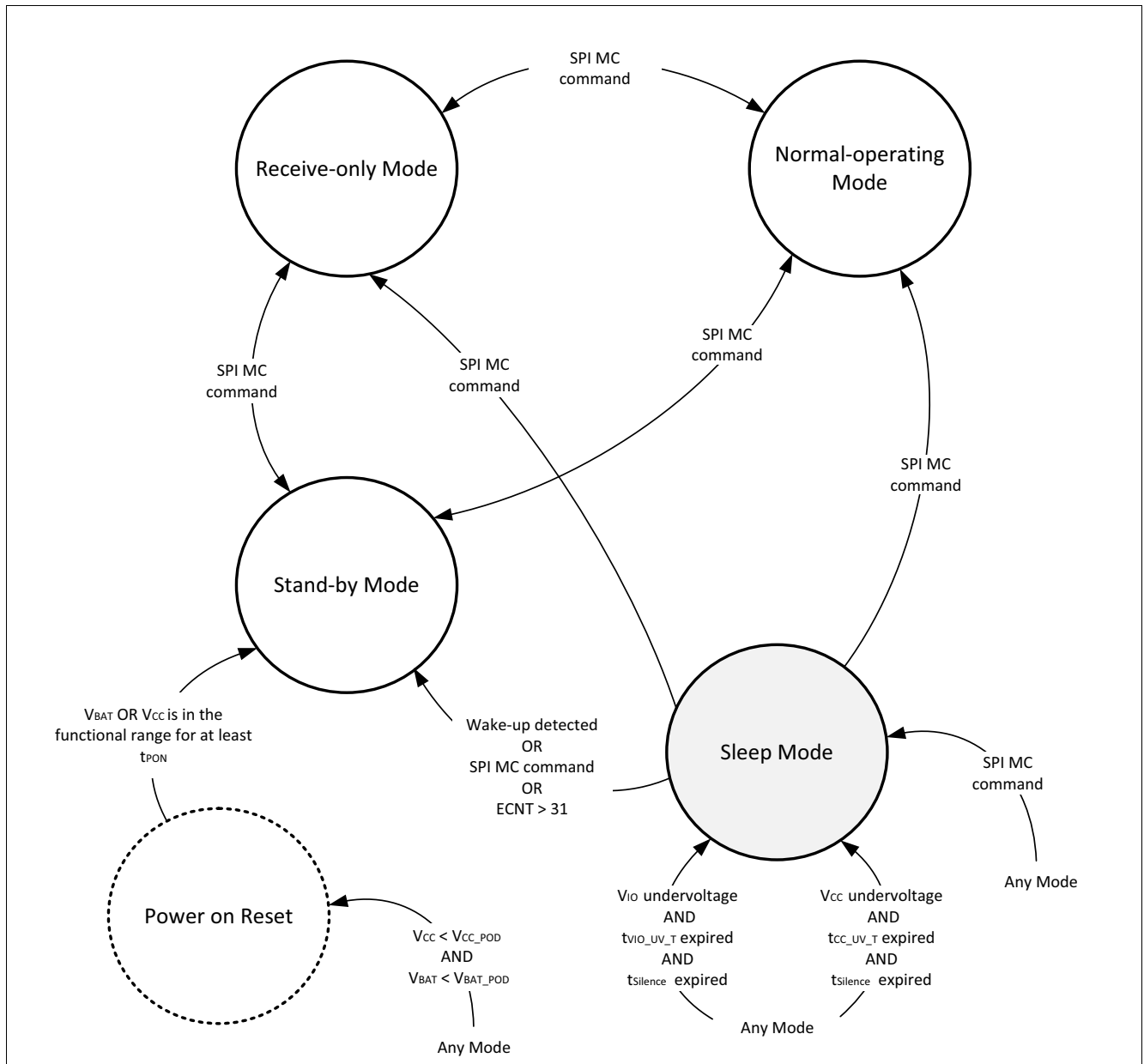

Figure 4 Mode of operation

Modes of Operation**Table 2 Types of Modes and Sub-Modes**

Type of mode	Mode	Sub-Mode
Normal power mode	Normal-operating mode	–
	Receive-only Mode	–
Low power mode	Stand-by Mode	–
	Sleep Mode	Sleep WUP Sub-Mode
		Selective Wake Sub-Mode
Selective Sleep Sub-Mode		

Modes of Operation

5.1 Normal-operating Mode

In Normal-operating mode all functions of the TLE9255W are available. The TLE9255W can receive data from the HS CAN bus as well as transmit data to the HS CAN bus.

- The transmitter is active and drives the serial data stream on the TxD input pin to the bus pins CANH, CANL.
- The normal mode receiver is active and converts the signals from the bus to a serial data stream on the RxD output pin.
- The bus biasing is on.
- The TxD timeout function is enabled ([Chapter 6.4](#)).
- The overtemperature protection is enabled ([Chapter 6.5](#)).
- The undervoltage detection on V_{BAT} is enabled ([Chapter 6.2.1](#)).
- The undervoltage detection on V_{CC} is enabled ([Chapter 6.2.2](#)).
- The undervoltage detection on V_{IO} is enabled ([Chapter 6.2.4](#)).
- The INH output pin is “high”.
- A valid wake-up pattern is not signalled in the SPI bit **WUP** ([Chapter 5.7.1](#)).
- Only if the selective wake function is enabled (**SWK_EN** = 1), then the HS CAN bus will be continuously monitored for a valid WUF ([Chapter 5.7.2](#)).
- Local wake-up function is disabled ([Chapter 5.7.3](#)).

Conditions for entering the Normal-operating Mode:

- Normal-operating Mode can be entered via an SPI MC command from any mode of operation.

Conditions for leaving the Normal-operating Mode:

- If $V_{IO} < V_{IO_UV}$ AND $t_{VIO_UV_T}$ has expired AND $t_{silence}$ has expired, then this triggers a mode change to Sleep Mode
- If $V_{CC} < V_{CC_UV}$ AND $t_{VCC_UV_T}$ has expired AND $t_{silence}$ has expired, then this triggers a mode change to Sleep Mode.
- An SPI MC command triggers a mode change.

Figure 5 shows possible mode changes.

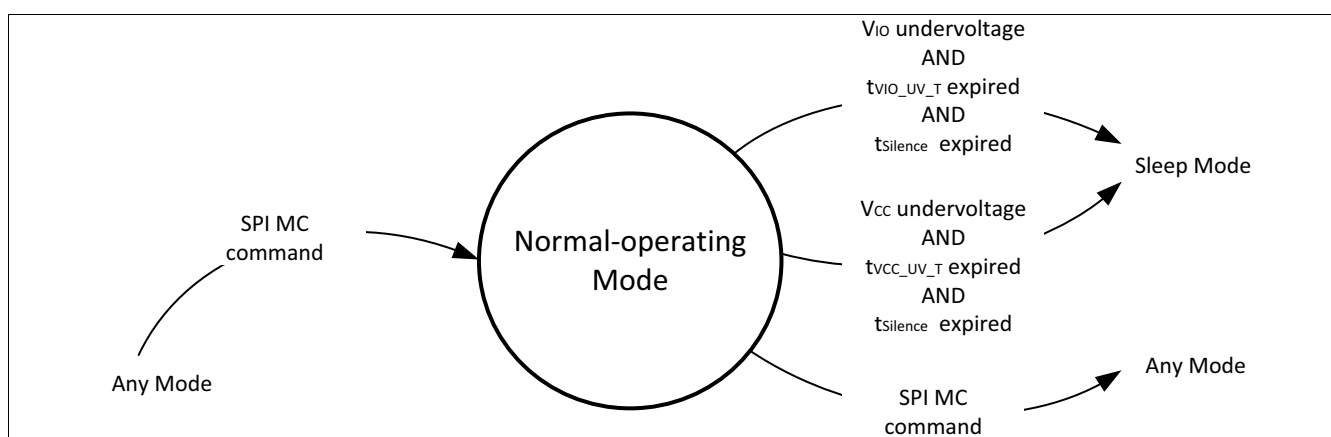

Figure 5 Mode changes in Normal-operating Mode

Modes of Operation

5.2 Receive-only Mode

In Receive-only Mode the transmitter is disabled and the receiver is enabled. The TLE9255W can receive data from the HS CAN bus, but cannot transmit data to the HS CAN bus.

- The transmitter is disabled and the data available on the TxD input is blocked.
- The RxD output pin indicates the data received by the normal-mode receiver.
- The bus biasing is on.
- The TxD timeout function is disabled ([Chapter 6.4](#)).
- The overtemperature protection is disabled ([Chapter 6.5](#)).
- The undervoltage detection on V_{BAT} is enabled ([Chapter 6.2.1](#)).
- The undervoltage detection on V_{CC} is enabled ([Chapter 6.2.2](#)).
- The undervoltage detection on V_{IO} is enabled ([Chapter 6.2.4](#)).
- The INH output pin is “high”.
- A valid wake-up pattern is not signalled in the SPI bit **WUP** ([Chapter 5.7.1](#)).
- Only if the selective wake function is enabled (**SWK_EN** = 1), then the HS CAN bus is continuously monitored for a valid WUF ([Chapter 5.7.2](#)).
- Local wake-up function is disabled ([Chapter 5.7.3](#)).

Conditions for entering the Receive-only Mode:

- Receive-only Mode can be entered via an SPI MC command from any mode of operation.

Conditions for leaving the Received-only Mode:

- If $V_{IO} < V_{IO_UV}$ AND $t_{VIO_UV_T}$ has expired AND $t_{silence}$ has expired, then this triggers a mode change to Sleep Mode.
- If $V_{CC} < V_{CC_UV}$ AND $t_{VCC_UV_T}$ has expired AND $t_{silence}$ has expired, then this triggers a mode change to Sleep Mode.
- An SPI MC command triggers a mode change.

Figure 6 shows possible mode changes.

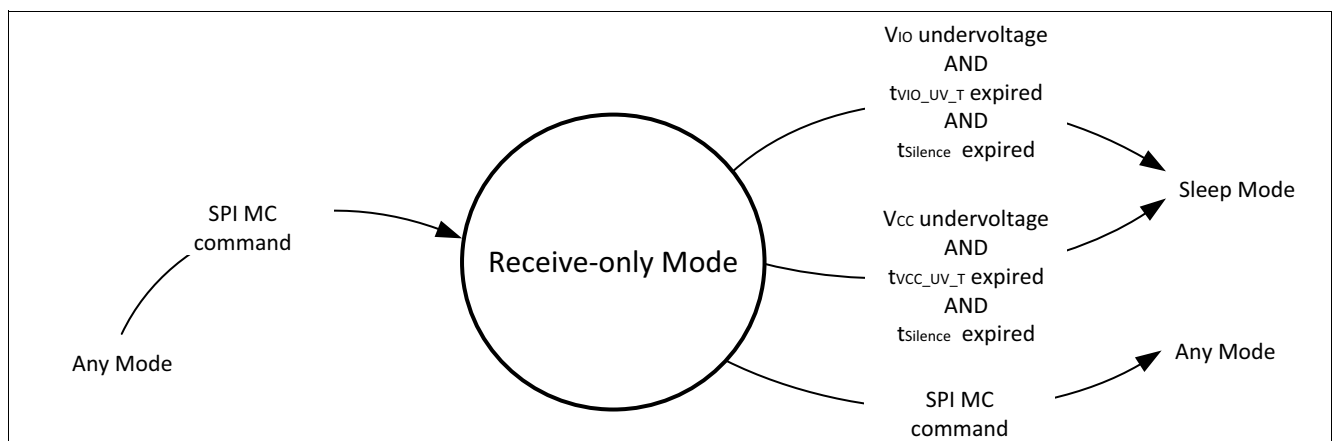

Figure 6 Mode changes in Receive-only Mode

Modes of Operation

5.3 Stand-by Mode

Stand-by Mode is a low power mode of the TLE9255W with both the transmitter and the receiver disabled. In Stand-by Mode the transceiver can neither send data to the HS CAN bus nor can it receive data from the HS CAN bus:

- The transmitter is disabled and the data available on the TxD input is blocked.
- The RxD output pin indicates a wake-up event (**Chapter 5.8**). If no wake-up event is pending, then the default value of the RxD output pin is “high”.
- After Power on Reset the bus biasing is off. **Chapter 5.6** describes the conditions for the bus biasing.
- The TxD timeout function is disabled (**Chapter 6.4**).
- The overtemperature protection is disabled (**Chapter 6.5**).
- The undervoltage detection on V_{BAT} is enabled(**Chapter 6.2.1**)
- The undervoltage detection on V_{CC} is enabled (**Chapter 6.2.2**).
- The undervoltage detection on V_{IO} is enabled (**Chapter 6.2.4**).
- The INH output pin is “high”.
- If the selective wake function is disabled (**SWK_EN** = 0), then the HS CAN bus is continuously monitored for a valid wake-up pattern (**Chapter 5.7.1**). If the selective wake function is enabled, then a valid wake-up pattern is not signalled in the SPI bit **WUP**.
- Only if the selective wake function is enabled (**SWK_EN** = 1), then the HS CAN bus is continuously monitored for a valid WUF (**Chapter 5.7.2**).
- Local wake-up function is enabled (**Chapter 5.7.3**).
- If $V_{IO} > V_{IO_UV}$, then a mode change is possible.

Modes of Operation

Conditions for entering the Stand-by Mode:

- After Power on Reset: If V_{CC} OR V_{BAT} is within the functional range for at least t_{PON} , then the TLE9255W enters Stand-by Mode.
- If a wake-up (WUP, WUF, LWU) is detected in Sleep Mode, then the TLE9255W enters Stand-by Mode.
- If the selective wake unit is active (Selective wake Sub-Mode) AND if the value of the error counter is 32 (see [Chapter 7.3](#)), then the TLE9255W enters Stand-by Mode.
- Stand-by Mode can be entered via an SPI MC command from any mode of operation.

Conditions for leaving the Stand-by Mode:

- If $V_{IO} < V_{IO_UV}$ AND $t_{VIO_UV_T}$ has expired AND $t_{silence}$ has expired, then this triggers a mode change to Sleep Mode.
- If $V_{CC} < V_{CC_UV}$ AND $t_{VCC_UV_T}$ has expired AND $t_{silence}$ has expired, then this triggers a mode change to Sleep Mode.
- An SPI MC command triggers a mode change.

Figure 7 shows possible mode changes.

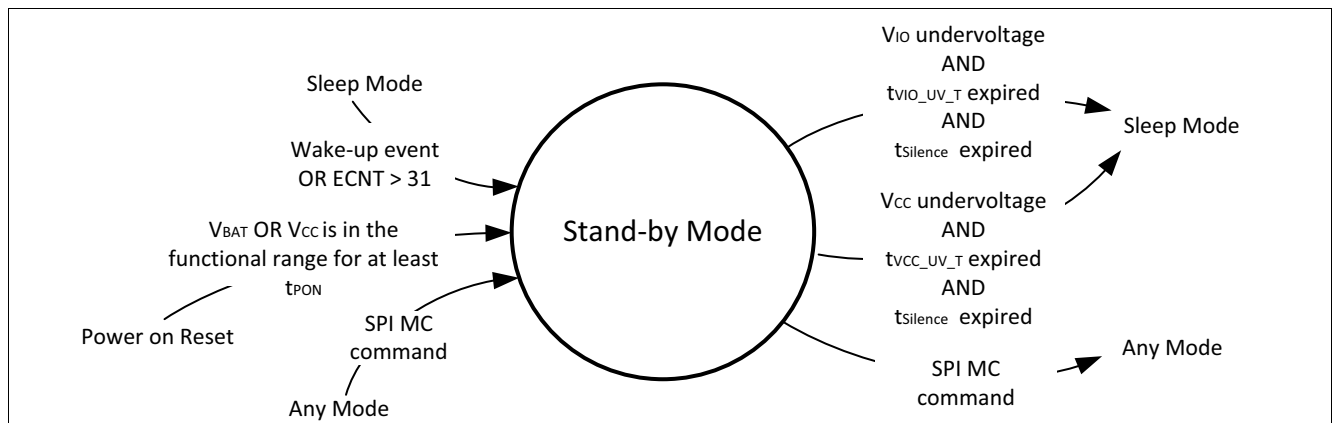

Figure 7 Mode changes in Stand-by Mode

Modes of Operation

5.4 Sleep Mode

Sleep mode is a low power mode with minimized quiescent current. If the TLE9255W detects a wake-up event in Sleep Mode, then it changes to Stand-by Mode. Sleep Mode has three Sub-Modes.

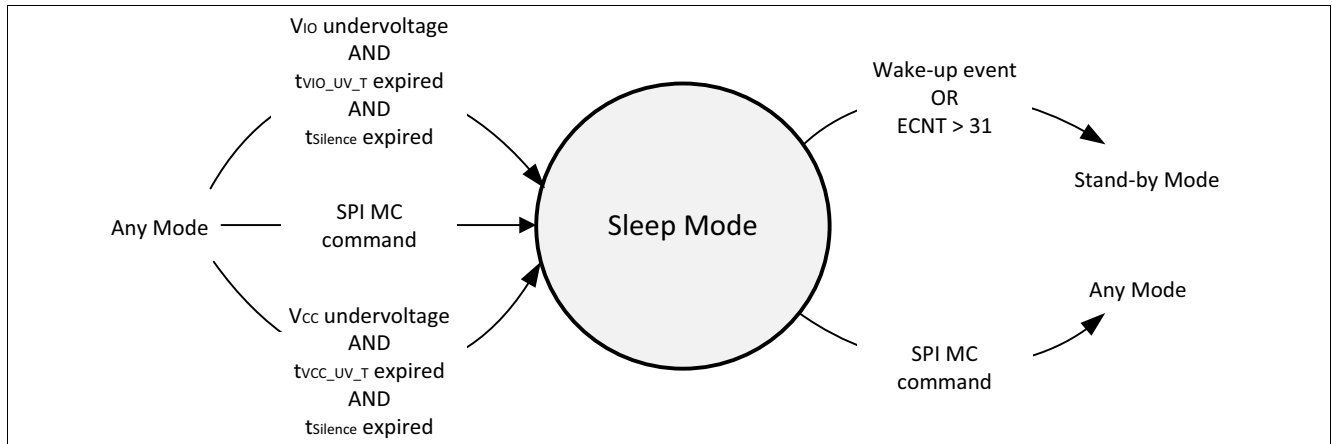

Figure 8 Mode change in Sleep Mode

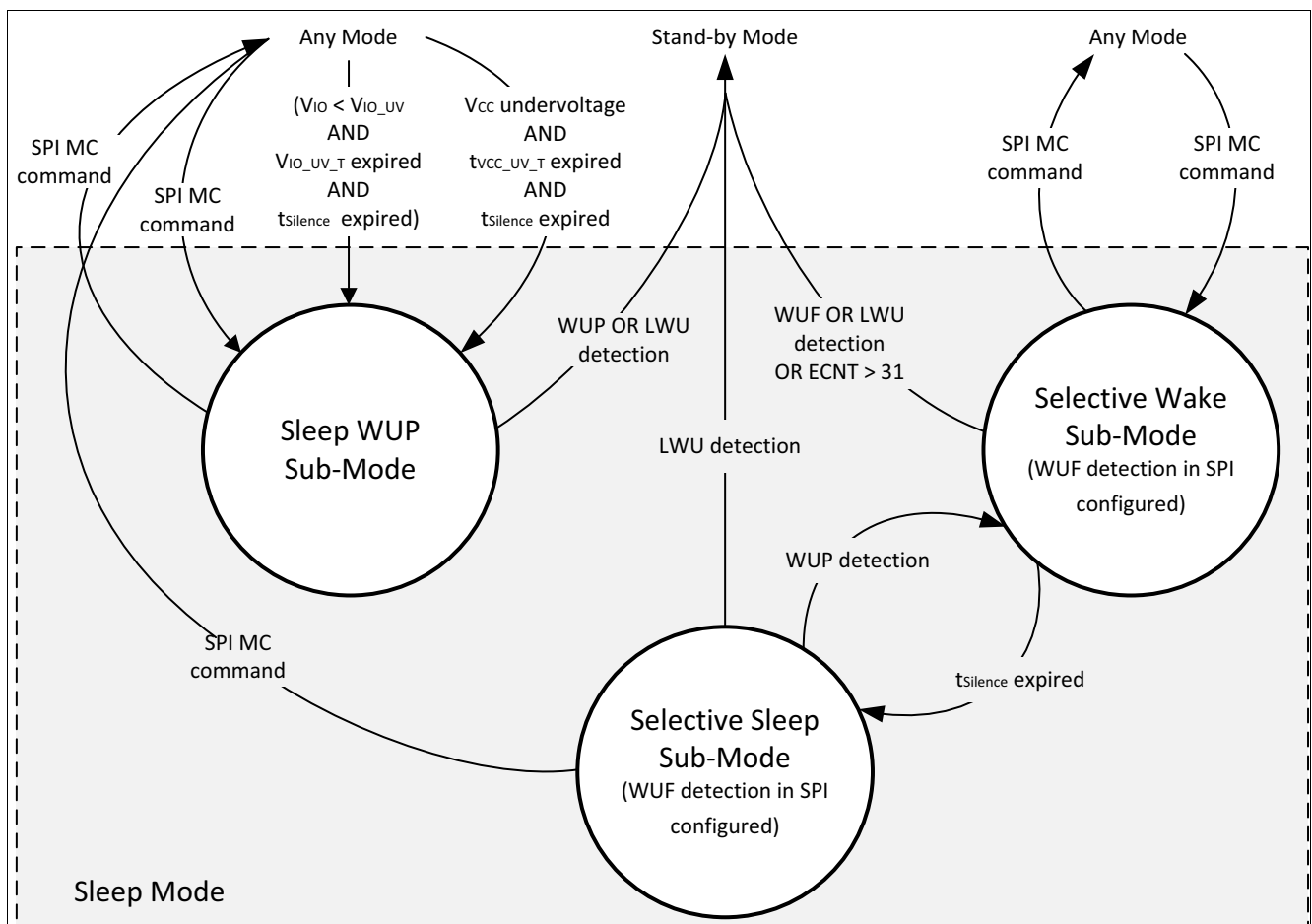

Figure 9 Sub-Modes in Sleep Mode

Modes of Operation

Figure 10 shows the internal behavior of the TLE9255W in case the microcontroller sends a change to Sleep Mode SPI command.

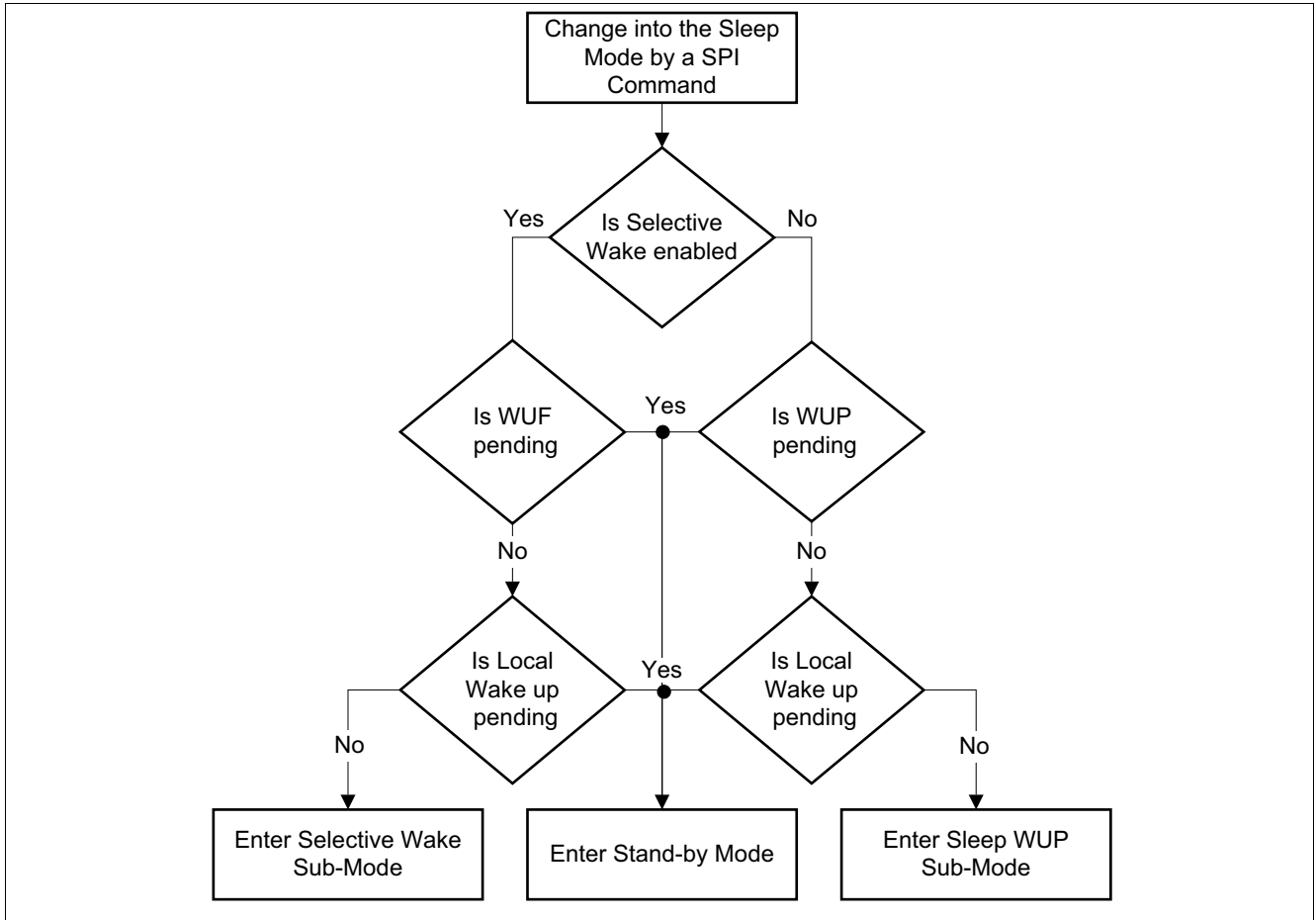

Figure 10 Internal behavior of the TLE9255W after receiving a change to Sleep Mode SPI command

Modes of Operation

5.4.1 Sleep WUP Sub-Mode

Sleep WUP Sub-Mode is a low power mode of the TLE9255W. Sleep WUP Sub-Mode reduces current consumption. The following conditions are valid for the Sleep WUP Sub-Mode:

- The transmitter is disabled and the data available on the TxD input is blocked.
- The value of the RxD output pin depends on the power supply circuit of V_{IO} .
 - Permanent power supply of V_{IO} (INH pin is not used)
The RxD output pin is “high”
 - The INH pin controls the power supply of V_{IO}
The RxD output pin is “low”
- If the t_{silence} timer has expired, then the bus biasing is off.
- The TxD timeout function is disabled ([Chapter 6.4](#)).
- The overtemperature protection is disabled ([Chapter 6.5](#)).
- The undervoltage detection on V_{BAT} ([Chapter 6.2.1](#)) is not signalled in the SPI bit **VBAT_UV**.
- The undervoltage detection on V_{CC} is disabled ([Chapter 6.2.2](#)).
- The undervoltage detection on V_{IO} ([Chapter 6.2.4](#)) is not signalled in the SPI bits **VIO_LTUV** and **VIO_STUV**.
- The INH output pin is “low”. The SPI bit **VBAT_CON** in the register **SWK_CTRL_1** controls the behavior of the INH pin.
- The HS CAN bus is continuously monitored for a valid wake-up pattern ([Chapter 5.7.1](#)).
- The HS CAN bus is not monitored for a valid WUF ([Chapter 5.7.2](#)).
- Local wake-up function is enabled.

Conditions for entering the Sleep WUP Sub-Mode:

- If $V_{IO} < V_{IO_UV}$ (V_{IO} undervoltage) AND $t_{VIO_UV_T}$ has expired AND t_{silence} has expired, then the TLE9255W enters Sleep WUP Sub-Mode.
- If $V_{CC} < V_{CC_UV}$ (V_{CC} undervoltage) AND $t_{VCC_UV_T}$ has expired AND t_{silence} has expired, then the TLE9255W enters Sleep WUP Sub-Mode. The SPI bit **STTS_EN** controls this state transition.
- The Sleep WUP Sub-Mode can be entered via an SPI MC command from any mode of operation.

Conditions for leaving the Sleep WUP Sub-Mode:

- If a wake-up (WUP, LWU) is detected in Sleep WUP Sub-Mode, then the TLE9255W enters Stand-by Mode.
- An SPI MC command triggers a mode change to any mode of operation.

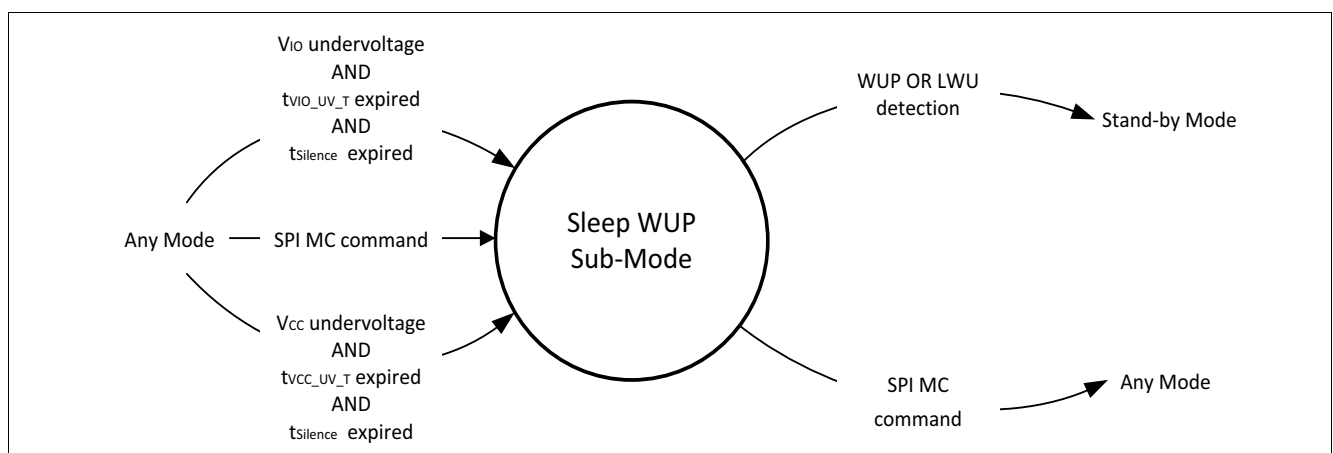

Figure 11 Mode change in Sleep WUP Sub-Mode

Modes of Operation

5.4.2 Selective Wake Sub-Mode

Selective Wake Sub-Mode is a low power mode of the TLE9255W. Only if the selective wake function is enabled (**SWK_EN**= 1), then the TLE9255W can enter Selective Wake Sub-Mode. [Chapter 7](#) describes the partial networking functionality and the configuration. The following conditions are valid for the Selective Wake Sub-Mode:

- The transmitter is disabled and the data available on the TxD input is blocked.
- The default value of the RxD output pin depends on the power supply circuit of V_{IO} .
 - Permanent power supply of V_{IO} (INH pin is not used)
The RxD output pin is “high”
 - The INH pin controls the power supply of V_{IO}
The RxD output pin is “low”
- The bus biasing is on.
- The TxD timeout function is disabled ([Chapter 6.4](#)).
- The overtemperature protection is disabled ([Chapter 6.5](#)).
- The undervoltage detection on V_{BAT} is enabled ([Chapter 6.2.1](#)).
- The undervoltage detection on V_{CC} is disabled([Chapter 6.2.2](#)).
- The undervoltage detection on V_{IO} is enabled ([Chapter 6.2.4](#)).
- The INH output pin is “low”. The SPI bit **VBAT_CON** in the register **SWK_CTRL_1** controls the behavior of the INH pin.
- A valid wake-up pattern is not signalled in the SPI bit **WUP** ([Chapter 5.7.1](#)).
- The HS CAN bus is continuously monitored for a valid WUF ([Chapter 5.7.2](#)).
- Local wake-up function is enabled.

Modes of Operation

Conditions for entering the Selective Wake Sub-Mode:

- The Selective Wake Sub-Mode can be entered via an SPI MC command from any mode of operation.
- If the TLE9255W detects a WUP in Selective Sleep Sub-Mode, then it enters Selective Wake Sub-Mode.

Conditions for leaving the Selective Wake Sub-Mode:

- If a wake-up (WUF, LWU) is detected in Selective Wake Sub-Mode, then Stand-by Mode is entered.
- If the error counter > 31 ([Chapter 7.3](#)) in Selective Wake Sub-Mode, then Stand-by Mode is entered.
- If t_{Silence} has expired, then Selective Sleep Sub-Mode is entered.
- An SPI MC command will trigger a mode change to any mode of operation.

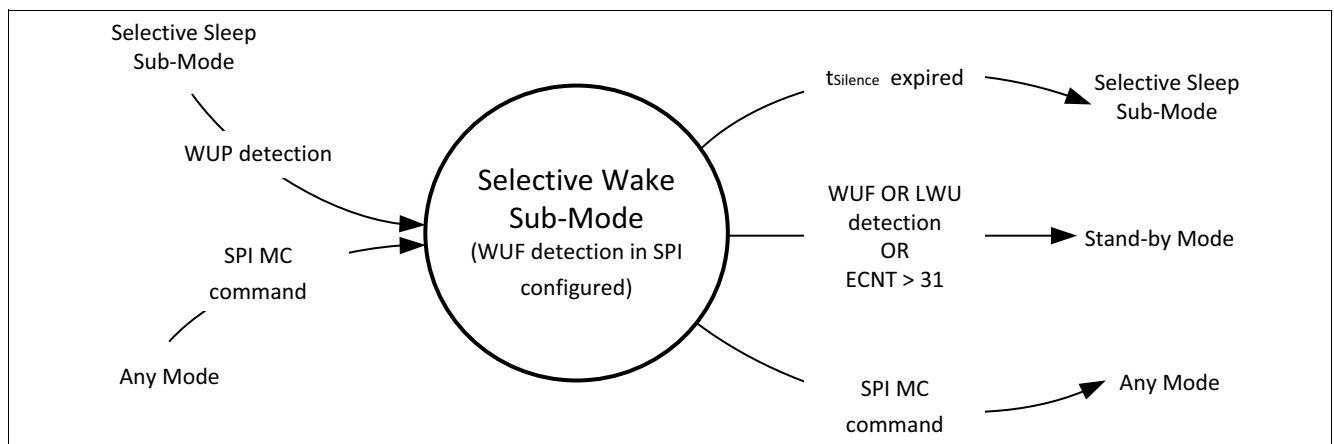

Figure 12 Mode change in Selective Wake Sub-Mode

Modes of Operation

5.4.3 Selective Sleep Sub-Mode

Selective Sleep Sub-mode is a low power mode with optimized quiescent current. The following conditions are valid for the Selective Wake Sub-Mode:

- The transmitter is disabled and the data available on the TxD input is blocked.
- The default value of the RxD output pin depends on the power supply circuit of V_{IO} .
 - Permanent power supply of V_{IO} (INH pin is not used)
The RxD output pin is “high”
 - The INH pin controls the power supply of V_{IO}
The RxD output pin is “low”
- The bus biasing is off.
- The TxD timeout function is disabled ([Chapter 6.4](#)).
- The overtemperature protection is disabled ([Chapter 6.5](#)).
- The undervoltage detection on V_{BAT} ([Chapter 6.2.1](#)) is not signalled in the SPI bit **VBAT_UV**.
- The undervoltage detection on V_{CC} is disabled ([Chapter 6.2.2](#)).
- The undervoltage detection on V_{IO} ([Chapter 6.2.4](#)) is not signalled in the SPI bits **VIO_LTUV** and **VIO_STUV**.
- The INH output pin is “low”. The SPI bit **VBAT_CON** in the register **SWK_CTRL_1** controls the behavior of the INH pin.
- The HS CAN bus is continuously monitored for a valid wake-up pattern ([Chapter 5.7.1](#)), but a valid wake-up pattern is not signalled in the SPI bit **WUP** ([Chapter 5.7.1](#)).
- The HS CAN bus is not monitored for a valid WUF ([Chapter 5.7.2](#)).
- Local wake-up function is enabled.

Conditions for entering the Selective Sleep Sub-Mode:

- If there is no communication on the HS CAN bus for longer than t_{Silence} in the Selective Wake Sub-Mode, then the TLE9255W enters the Selective Sleep Sub-Mode.

Conditions for leaving the Selective Sleep Sub-Mode:

- If a WUP is detected, then Selective Wake Sub-Mode is entered.
- If an LWU has been detected, then Stand-by Mode will be entered.
- An SPI MC command triggers a mode change to any mode of operation.

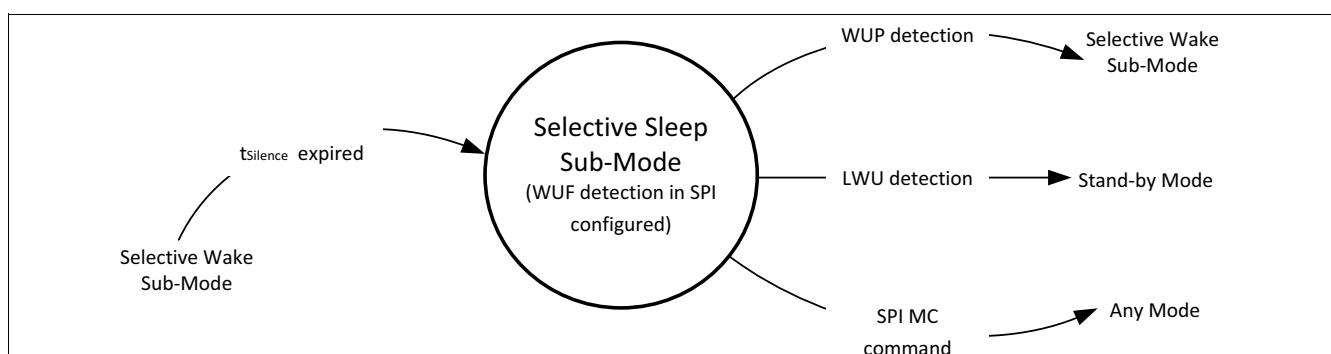

Figure 13 Mode change in Selective Sleep Sub-Mode

Modes of Operation

5.5 Power On Reset

Power on Reset is a transition state of the TLE9255W after power is applied and the transceiver is not yet fully functional.

- The transmitter and receiver are disabled.
- The bus biasing is off.
- The TxD timeout function is disabled.
- The overtemperature protection is disabled.
- The undervoltage detection on V_{BAT} is enabled ([Chapter 6.2.1](#)), but it is not signalled in the SPI bit **VBAT_UV**.
- The undervoltage detection on V_{CC} is disabled.
- The undervoltage detection on V_{IO} is enabled ([Chapter 6.2.4](#)), but it is not signalled in the SPI bits **VIO_LTUV** and **VIO_STUV**.
- The SPI communication is blocked (MOSI, SCLK, CSN),
- RxD and MISO pins are high impedance.
- TxD pin is blocked
- If $V_{BAT} > V_{BAT_POD}$ OR $V_{CC} > V_{CC_POD}$, then the INH output pin is switched on
- All SPI registers are reset to default values.
- The HS CAN bus is not continuously monitored for a valid wake-up pattern ([Chapter 5.7.1](#))
- The HS CAN bus is not monitored for a valid WUF ([Chapter 5.7.2](#)).
- Local wake-up function is disabled.

Conditions for entering the Power on Reset:

- $V_{BAT} < V_{BAT_POD}$ AND $V_{CC} < V_{CC_POD}$ threshold.

Conditions for leaving the Power on Reset:

- If V_{BAT} is within the functional range for at least t_{PON} OR if V_{CC} is within the functional range for at least t_{PON} , then the TLE9255W enters Stand-by Mode

Figure 14 shows power up behavior and power down behavior:

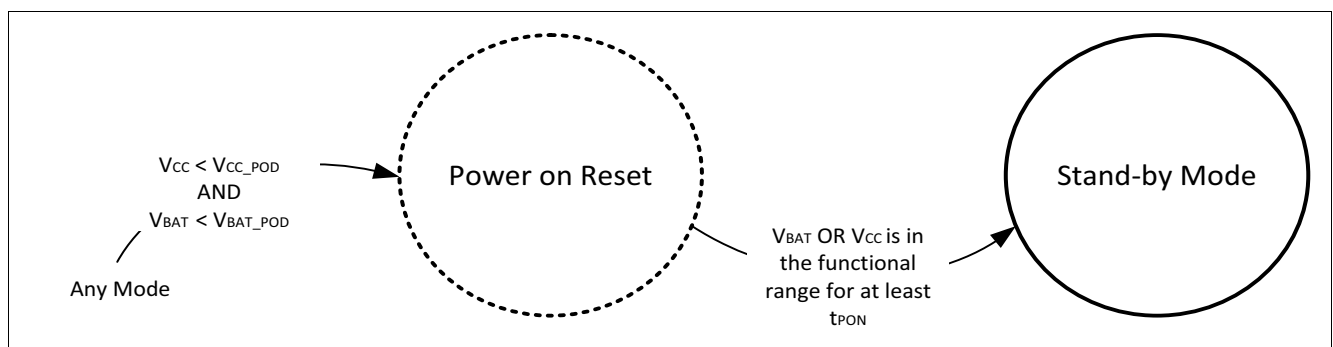

Figure 14 Power down and power up behavior

SPI bit **POR**

The **POR** flag indicates that all registers are reset and the state machine is in the default mode (Stand-by Mode) If all of the following conditions are fulfilled, then the **POR** flag is set:

Modes of Operation

- V_{BAT} is within the functional range for at least t_{PON} OR V_{CC} is within the functional range for at least t_{PON} , then the TLE9255W enters Stand-by Mode
- V_{IO} is within the functional range (SPI communication is possible)

Any of the following events resets the **POR** flag:

- an SPI clear command
- a transition to the Normal-operating Mode

Modes of Operation

5.6 Automatic Bus Voltage Biasing

The automatic bus voltage biasing improves EMC performance of the entire network and increases the reliability of communication performance in networks using CAN partial networking.

The automatic bus voltage biasing is enabled in all low power modes. The biasing unit operates independently from all other transceiver functions and only depending on the network activity ($t_{Silence}$). If $t_{Silence}$ has expired, then there is no activity on the CAN bus. The $t_{Silence}$ timer is restarted under the following conditions:

- If $t_{Silence}$ has expired in Sleep WUP Sub-Mode AND a WUP is detected
- If $t_{Silence}$ has not expired in Sleep WUP Sub-Mode AND a rising or falling edge is detected AND the pulse width (dominant or recessive) is greater than t_{Filter}
- If a WUP is detected in Selective Sleep Sub-Mode
- If $t_{Silence}$ has expired in Stand-by Mode AND a WUP is detected
- If the $t_{Silence}$ has not expired in Stand-by Mode AND a rising edge or a falling edge is detected AND the pulse width (dominant or recessive) is greater than t_{Filter}
- If a rising or falling edge is detected in any other mode AND the pulse width (dominant or recessive) is greater than t_{Filter}

If there is no activity on the bus for longer than $t_{SILENCE}$, then the internal resistors bias the bus pins towards GND. On detection of a valid wake-up pattern (WUP), the internal biasing is enabled and terminates the biasing resistors towards 2.5 V within $t > t_{RW_Bias}$.

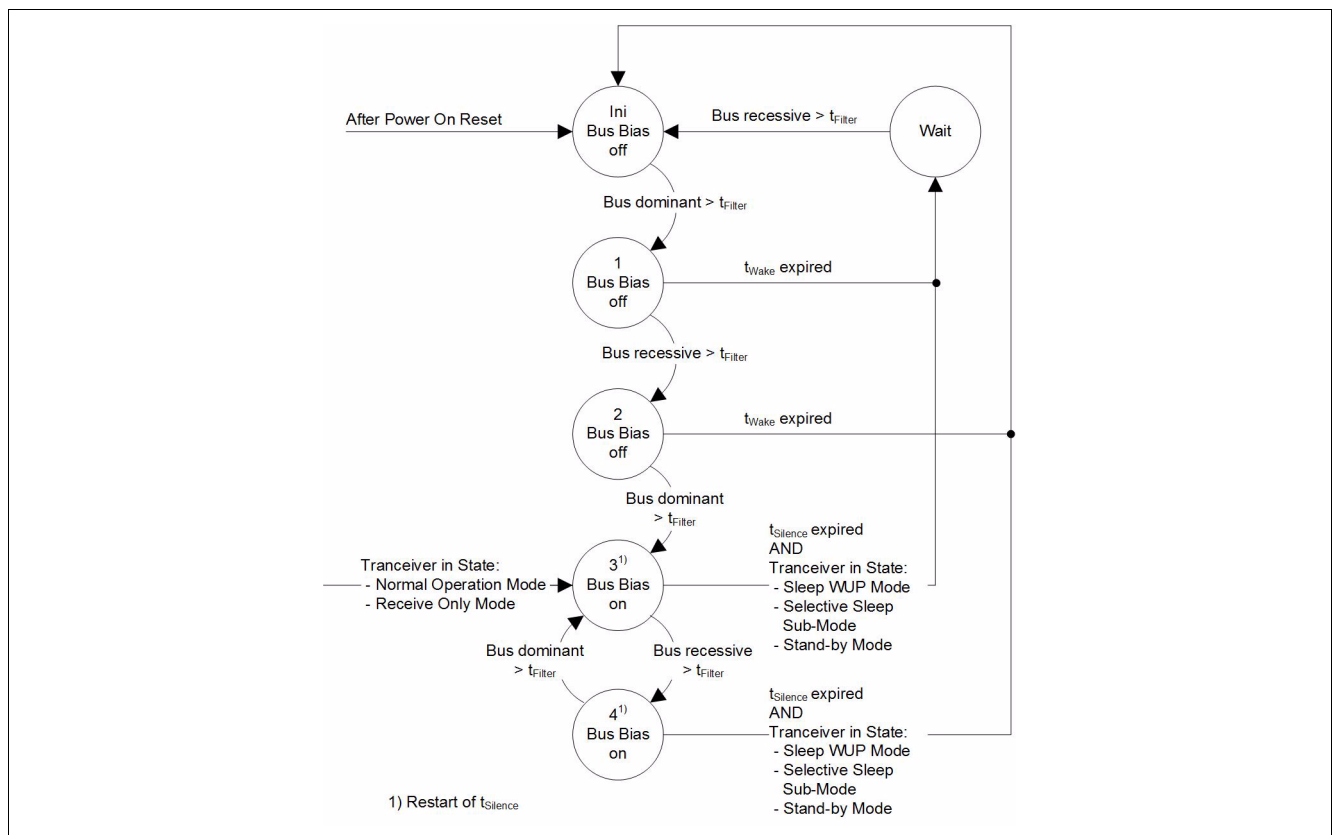

Figure 15 Bus Biasing and $t_{Silence}$

Modes of Operation

5.7 Wake-up event

Valid wake-up events are:

- a Wake-up pattern (WUP) in Sleep WUP Sub-Mode
 - a Wake-up frame (WUF) in Selective Wake Sub-Mode
 - a Local Wake-up (LWU) in Sleep WUP Sub-Mode, Selective Sleep Sub-Mode or Selective Wake Sub-Mode
- If a valid wake-up event is detected, then this triggers a mode change to Stand-by Mode.

5.7.1 Wake-up pattern (WUP)

Within the maximum wake-up time t_{WAKE} , the wake-up pattern consists of the following sequence (see Figure 16):

- a dominant signal with pulse width $t > t_{Filter}$
- a recessive signal with pulse width $t > t_{Filter}$
- a dominant signal with pulse width $t > t_{Filter}$

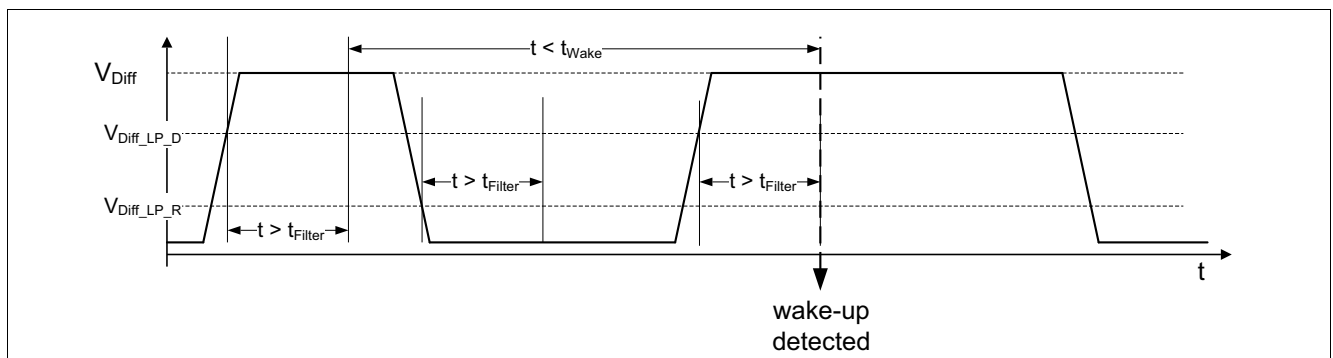

Figure 16 Wake-up pattern

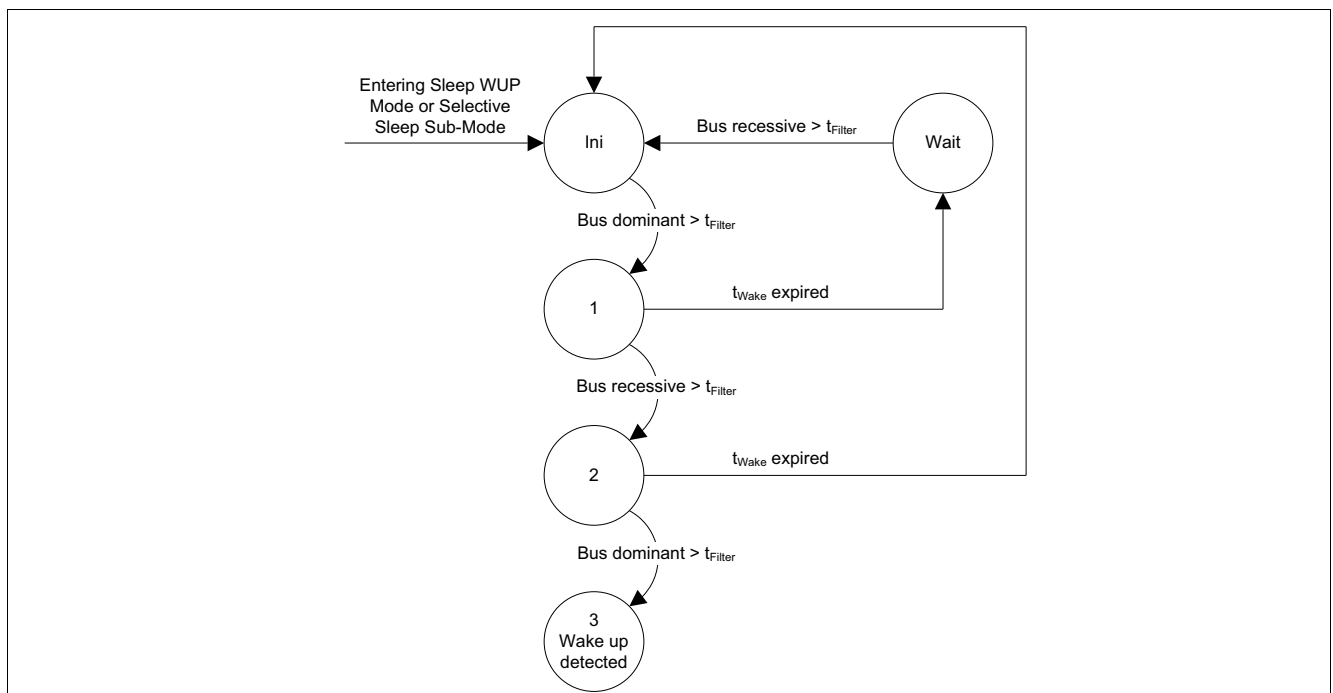

Figure 17 WUP detection

Modes of Operation

The **WUP** bit in the register **WAKE_STAT** indicates detection of a wake-up pattern on the HS CAN bus. If the transceiver is not in the Selective Sleep Sub-Mode AND if the transceiver detects a valid wake-up pattern, then the WUP bit is set. An SPI clear command resets the bit. A wake-up is not executed under the following conditions:

- A mode change to Normal-operating Mode is performed during the wake-up pattern.
- The maximum wake-up time t_{WAKE} expires before a valid WUP is detected.
- The transceiver is powered down ($V_{CC} < V_{CC_POD}$ AND $V_{BAT} < V_{BAT_POD}$).

5.7.2 Wake-up frame (WUF)

If the selective wake unit is enabled (**SWK_EN** =1), then the selective wake unit continuously monitors the HS CAN Bus for a valid wake-up frame. If a valid WUF is detected, then the **WUF** bit in the register **WAKE_STAT** is set to "1". An SPI clear command resets the **WUF** bit. **Chapter 7** describes the selective wake feature.

Modes of Operation

5.7.3 Local Wake-up (LWU)

The WAKE input pin can detect a rising edge as well as a falling edge as a wake-up event (configurable in **LWU_NEG**, **LWU_POS**). The **LWU** bit in the register **WAKE_STAT** indicates that a local wake-up is detected on the local wake-up pin. The transceiver sets the **LWU** bit. An SPI command resets the **LWU** bit. The **LWU_DIR** bit in the register **WAKE_STAT** indicates on which edge a local wake-up has been detected. The transceiver sets the **LWU_DIR** flag and it is only valid, if a local wake-up has been detected. **Chapter 10.6.3** describes the local wake-up timing.

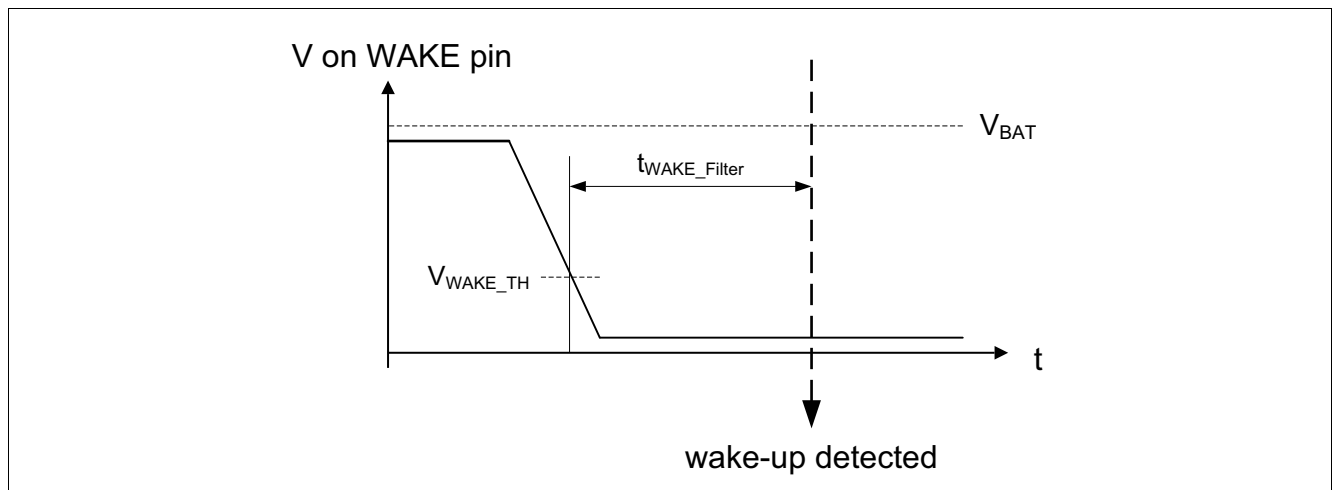

Figure 18 Local wake-up negative edge

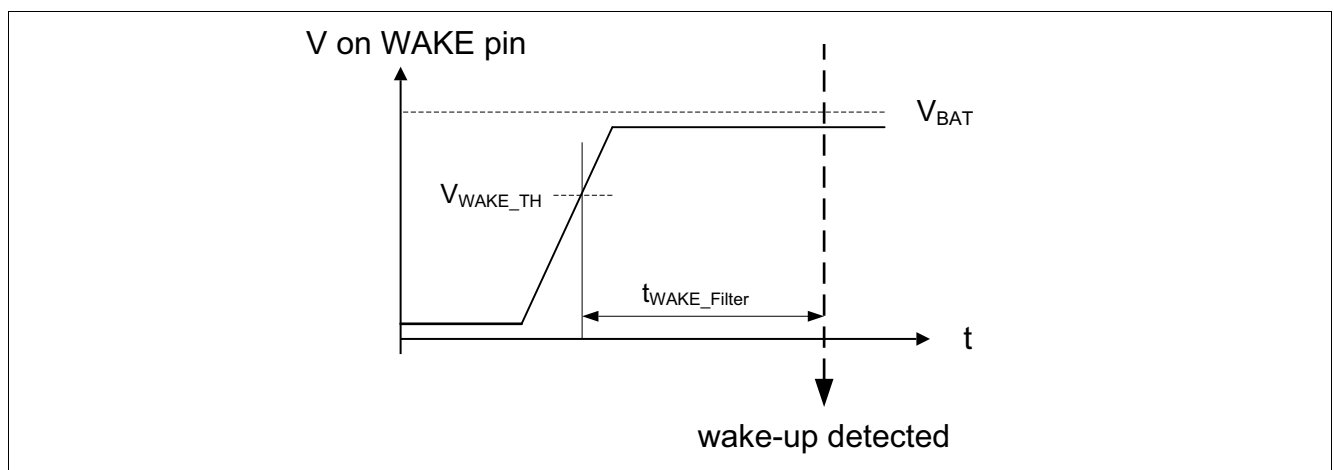

Figure 19 Local wake-up positive edge

Modes of Operation

5.8 RxD pin wake-up behavior

The RxD output pin indicates a wake-up event to the microcontroller. On detection of a valid wake-up event the RxD output pin reacts with one of the following behaviors, depending on the **WAKE_TOG** bit in the SPI register **HW_CTRL**:

- RxD output pin is set to “low”
- RxD output pin starts to toggle

If Stand-by Mode is re-entered by a mode change (microcontroller) the previous indication of a valid wake-up event is not signalled on the RxD pin. Only if a new wake-up event has been detected, the RxD pin indicates the wake-up event. The clearing of a **WUP**, **WUF** or **LWU** has no influence on the behavior of the RxD pin.

5.8.1 RxD permanent “low”

If a valid wake-up event is detected AND if SPI bit **WAKE_TOG** = 0, then the RxD output pin is set to “low”. If a mode change occurs, then the RxD output pin behavior is defined by the new state.

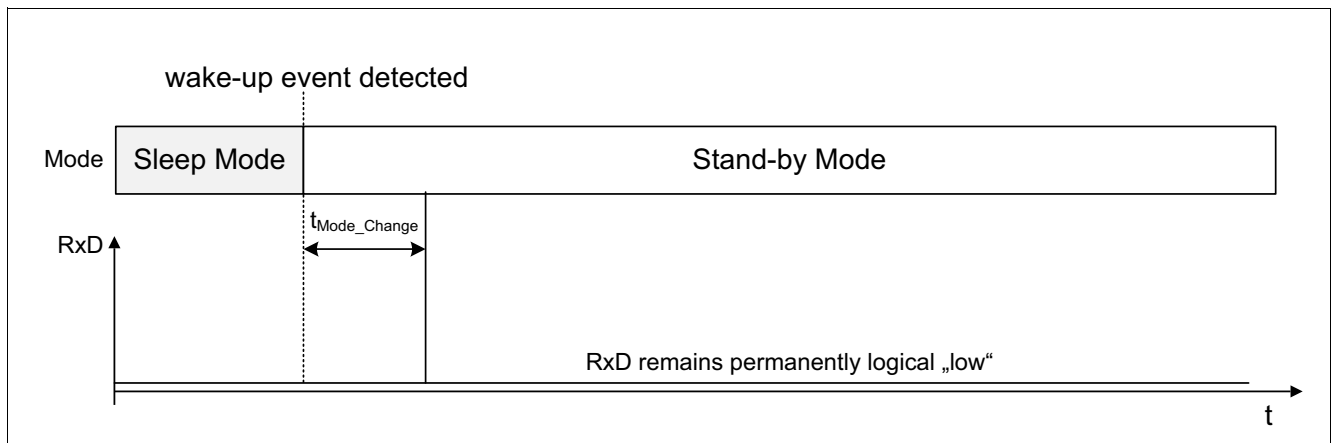

Figure 20 RxD “low” after wake-up event

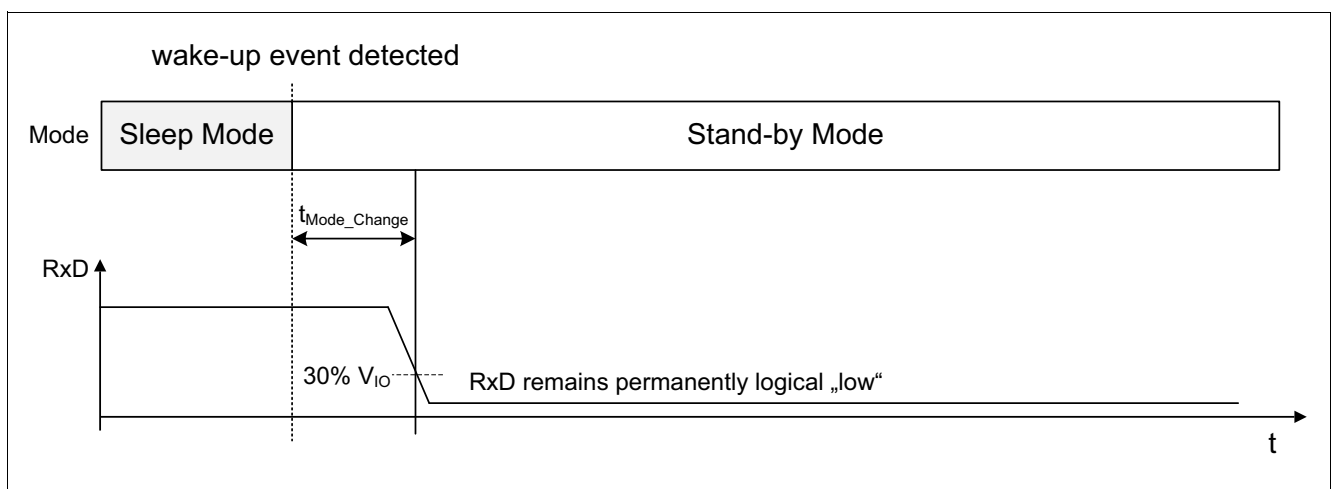

Figure 21 RxD “low” after wake-up event (permanently supplied V_{IO})

Modes of Operation

5.8.2 RxD Toggle

If **WAKE_TOG** is set to 1 AND if a valid wake-up event is detected AND if V_{IO} is within the functional range, then the RxD output pin starts to toggle from “low” to “high” and “high” to “low” with time period of t_{Toggle} . **Figure 22** and **Figure 23** show this behavior. If a mode change occurs, then the RxD output pin behavior is defined by the new state.

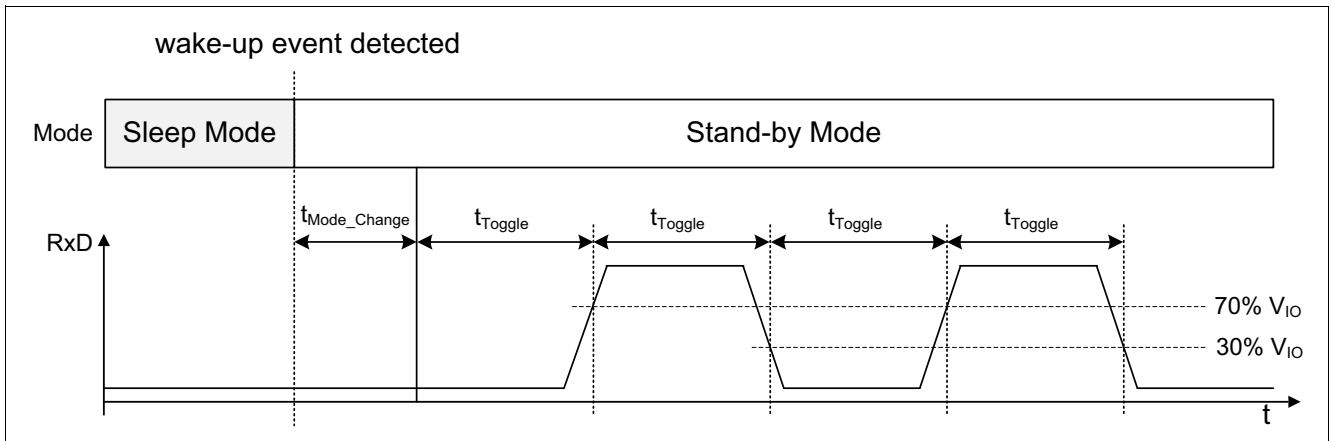

Figure 22 RxD toggling behavior after wake-up event

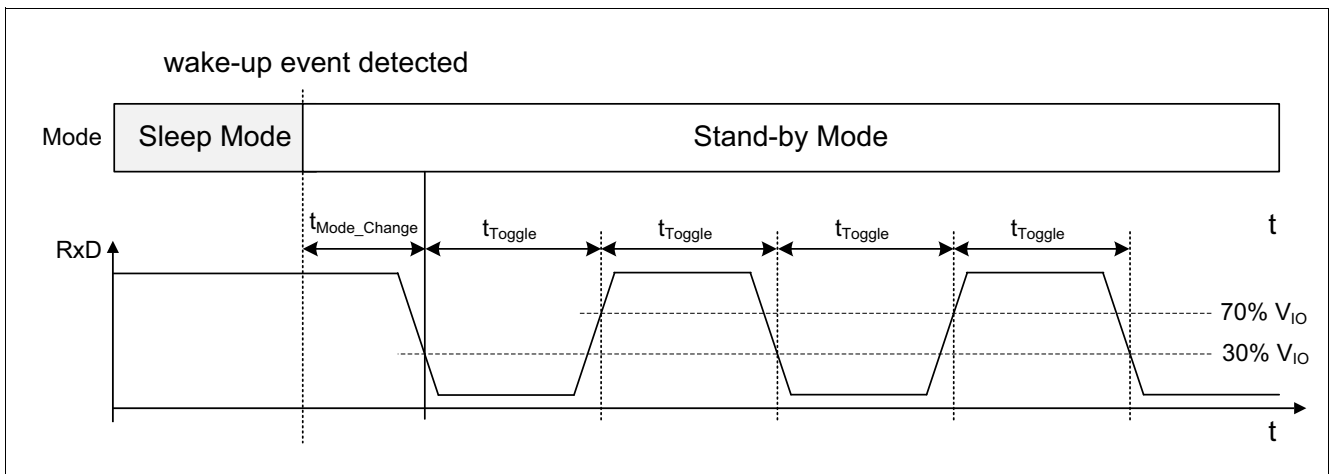

Figure 23 RxD toggling behavior after wake-up event (permanently supplied V_{IO})

6 Fail Safe Functions

6.1 Short Circuit Protection

The CANH and CANL bus pins are proven to cope with a short circuit fault to GND and to the supply voltages. A current limiting circuit protects the transceiver from damage.

6.2 Undervoltage detection

The TLE9255W has independent undervoltage detection on V_{BAT} , V_{CC} and V_{IO} . Undervoltage events at these pins may have impact on the functionality of the device and also may change the mode of operation.

6.2.1 Undervoltage detection on V_{BAT}

If the power supply $V_{BAT} < V_{BAT_UV}$ for more than the glitch filter time t_{VBAT_filter} , then an undervoltage is detected. On detection of undervoltage the TLE9255W performs the following actions:

- disable Local wake-up
- Set the bit **VBAT_UV** in the SPI register **TRANS_UV_STAT** to "1". After the completion of a Power on Reset or after a transition from Sleep Mode to Stand-by Mode the V_{BAT} supply stabilization period must be completed before an undervoltage notification can be recorded in the **VBAT_UV** bit. The undervoltage notification is only possible once the V_{BAT} supply has exceeded the threshold V_{BAT_UV} , that is $V_{BAT} > V_{BAT_UV}$. **Figure 25** shows this scenario.

Only an SPI command can reset the undervoltage bit **VBAT_UV** (see **Chapter 8.2**). The glitch filter is implemented in order to prevent an undervoltage detection due to short voltage transients on V_{BAT} . **Figure 24** shows the effect of glitch filter time in different undervoltage scenarios.

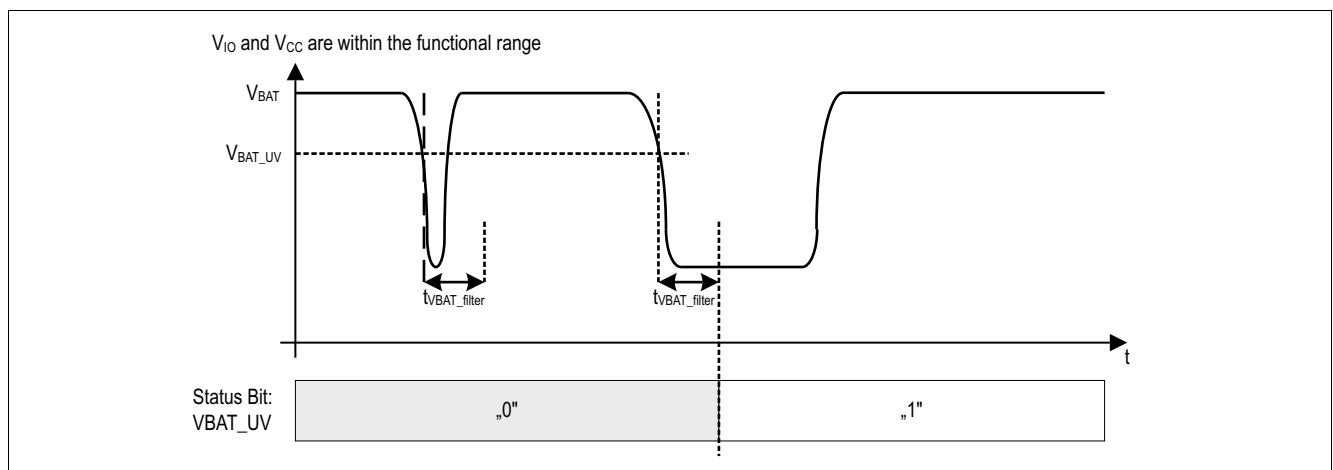

Figure 24 Undervoltage detection V_{BAT}

Fail Safe Functions

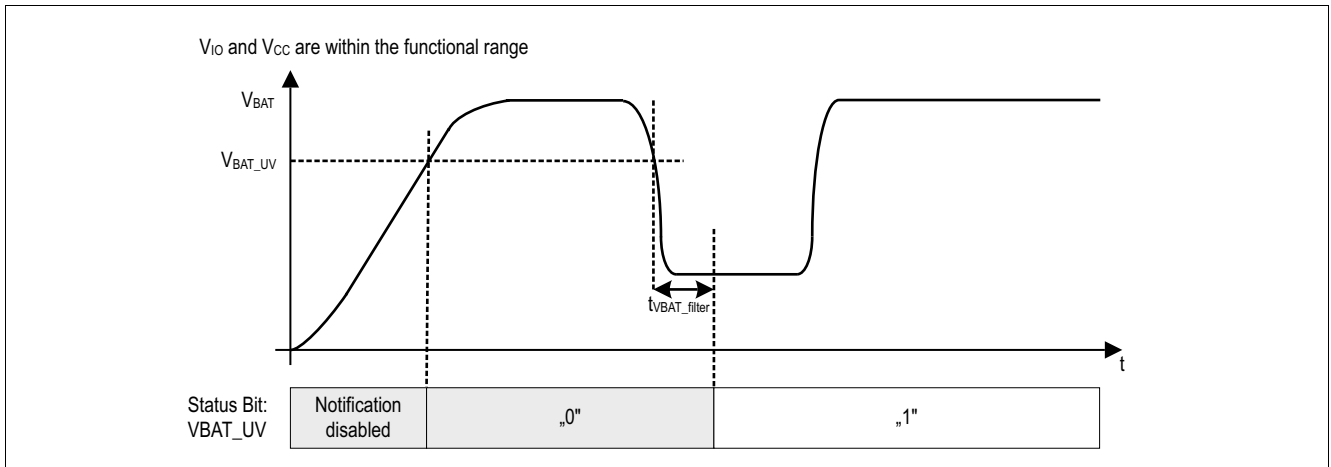

Figure 25 Undervoltage detection V_{BAT} during V_{BAT} supply stabilization period

After power up the application can set the **VBAT_CON** to "0" in the SPI Register **SUPPLY_CTRL** in order to disable undervoltage detection.

Fail Safe Functions

6.2.2 Short-term Undervoltage detection on V_{CC}

If the power supply $V_{CC} < V_{CC_UV}$ for more than the glitch filter time $t_{V_{CC_filter}}$, then a short-term undervoltage on V_{CC} is detected. The glitch filter prevents an undervoltage detection due to short voltage transients on V_{CC} . On detection of short-term undervoltage the TLE9255W performs the following actions:

- Set short-term undervoltage bit **VCC_STUV** to “1” in the SPI register **TRANS_UV_STAT**. Only after the completion of a Power on Reset, the V_{CC} supply stabilization period must be completed before an undervoltage notification can be recorded in the **VCC_STUV** bit. After Power on Reset the undervoltage notification is only possible once the V_{CC} supply has exceeded the threshold V_{CC_UV} , that is $V_{CC} > V_{CC_UV}$. **Figure 27** shows this scenario.
- disable the transmitter

An SPI command can reset the undervoltage bit **VCC_STUV**. If $V_{CC} > V_{CC_UV}$ for more than the glitch filter time $t_{V_{CC_filter}}$ AND if the transmitter recovery time $t_{V_{CC_recovery}}$ has expired, then the transmitter is re-enabled.

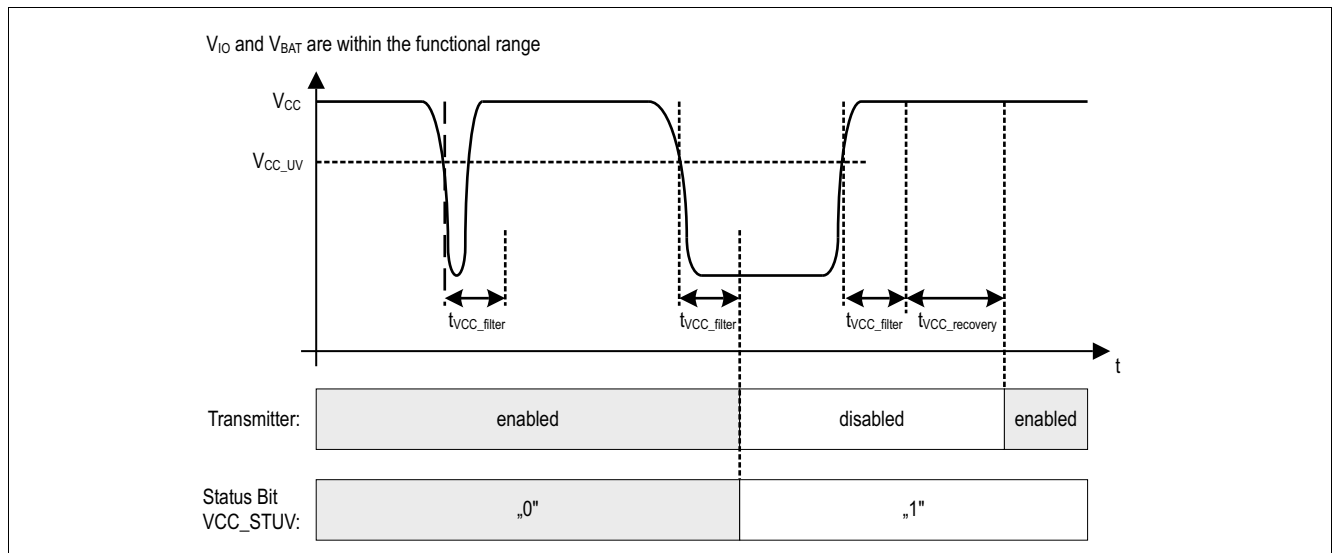

Figure 26 V_{CC} undervoltage detection

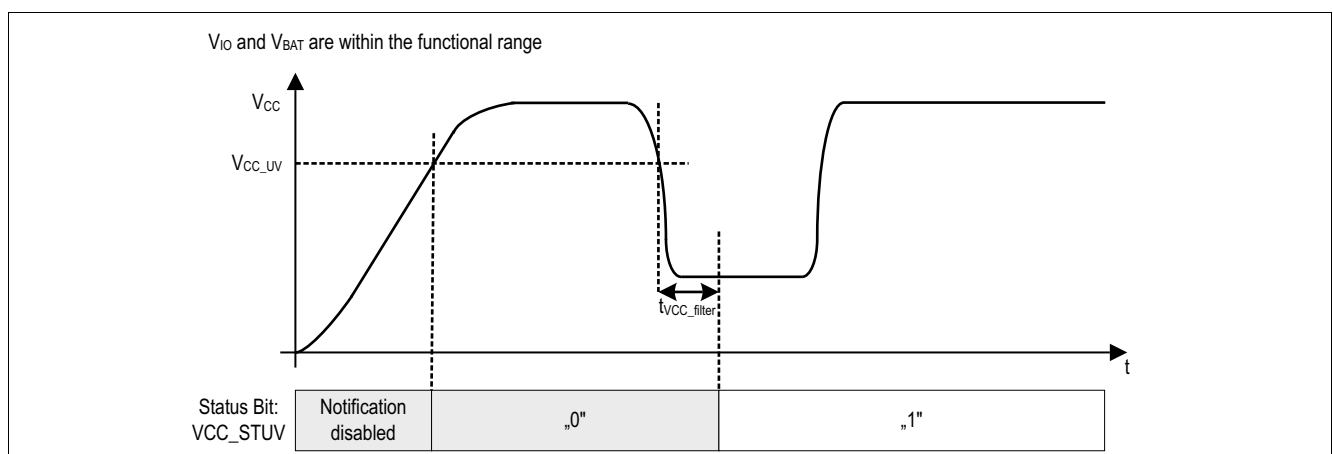

Figure 27 Undervoltage detection V_{CC} during V_{CC} supply stabilization period after Power on Reset

Fail Safe Functions

6.2.3 Long-term undervoltage detection on V_{CC}

If $V_{CC} < V_{CC_UV}$ for more than the glitch filter time $t_{V_{CC_filter}}$, then the undervoltage detection timer is started. If $t_{V_{CC_UV_T}}$ has expired, then a long-term undervoltage is detected and the bit **VCC_LTUV** is set to "1". Besides, if the SPI bit **STTS_EN** = 1 (default value) AND if $t_{Silence}$ has expired, then a state transition to Sleep WUP Sub-Mode is triggered. If $V_{CC} > V_{CC_UV}$ for more than the glitch filter time $t_{V_{CC_filter}}$, then the timer $t_{V_{CC_UV_T}}$ is stopped and reset. Only an SPI command can reset the undervoltage bit **VCC_LTUV**. The $t_{V_{CC_UV_T}}$ can be configured in the SPI register **SUPPLY_CTRL**.

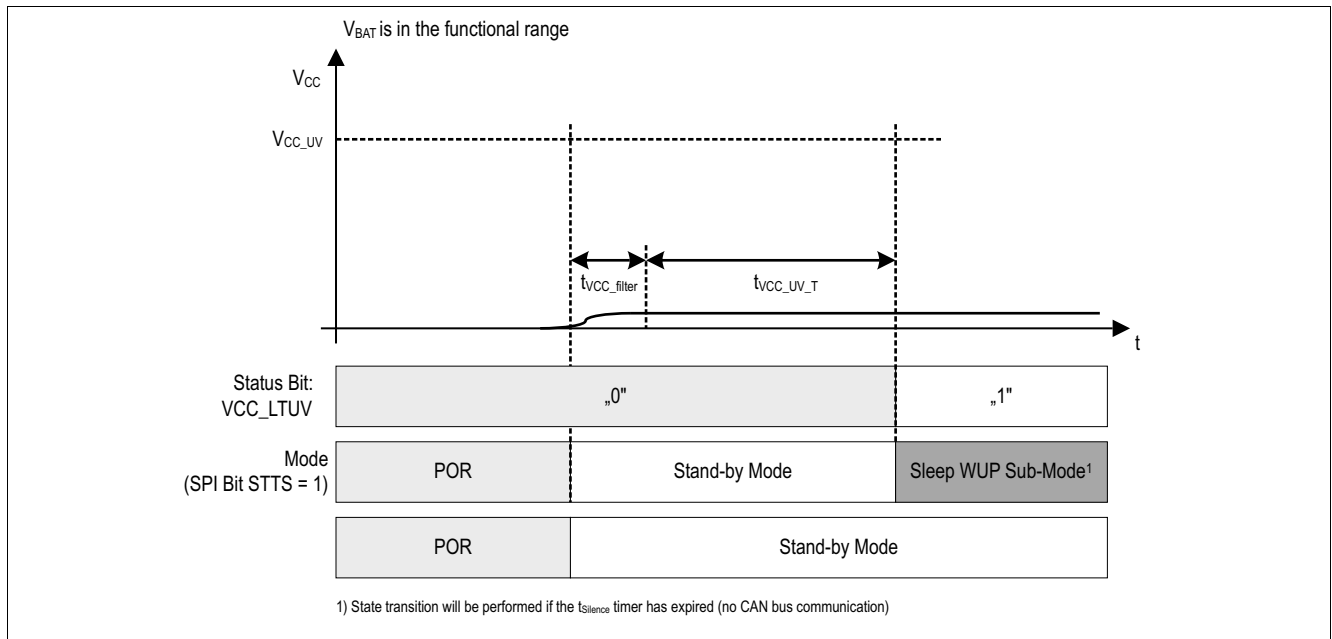

Figure 28 V_{CC} long-term undervoltage detection after power up

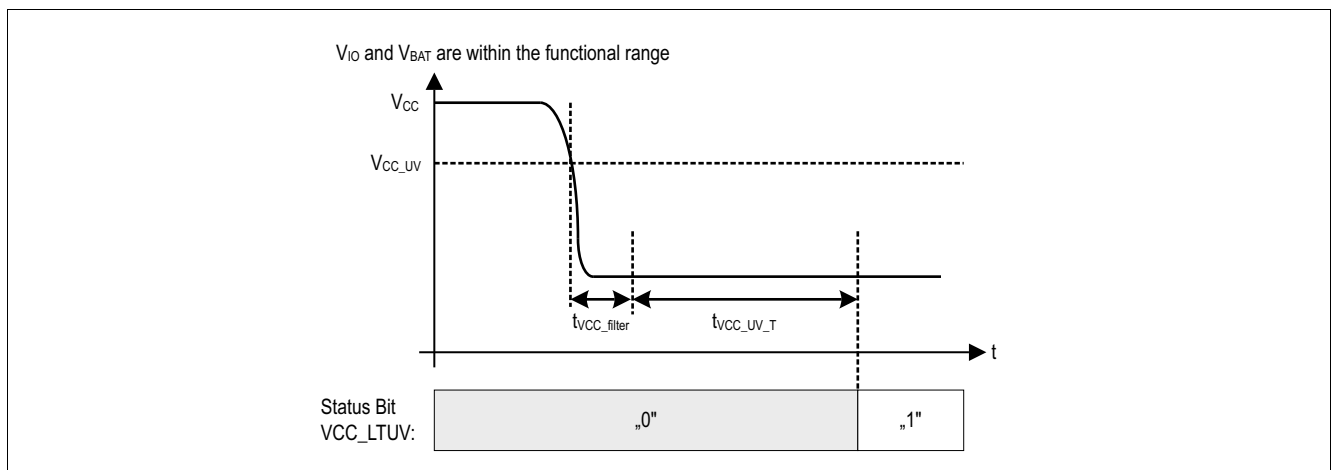

Figure 29 V_{CC} long-term undervoltage detection during operation

6.2.4 Short-term Undervoltage detection on V_{IO}

If the power supply $V_{IO} < V_{IO_UV}$ for more than the glitch filter time $t_{V_{IO_filter}}$, then short-term undervoltage on V_{IO} is detected. The glitch filter prevents an undervoltage detection due to short voltage transients on V_{IO} . On detection of short-term undervoltage the TLE9255W performs the following actions:

Fail Safe Functions

- Set the short-term undervoltage bit **VIO_STUV** to “1” in the SPI register **TRANS_UV_STAT**. After the completion of a Power on Reset, the V_{IO} supply stabilization period must be completed before an undervoltage notification can be recorded in the **VIO_STUV** bit. After Power on Reset the undervoltage notification is only be possible once the V_{IO} supply has exceeded the threshold V_{IO_UV} , that is $V_{IO} > V_{IO_UV}$. **Figure 31** shows this scenario.
- set the RxD pin to “low”
- disable SPI communication by switching the MISO pin to high impedance
- TLE9255W ignores all signals on the input TxD pin

Only an SPI command can reset the undervoltage bit **VIO_STUV**. If V_{IO} has recovered ($V_{IO} > V_{IO_UV}$) for more than the glitch filter time t_{VIO_filter} AND if the $t_{VIO_recovery}$ time has expired, then the RxD pin returns to normal functionality depending on the mode of operation and the SPI communication is restored.

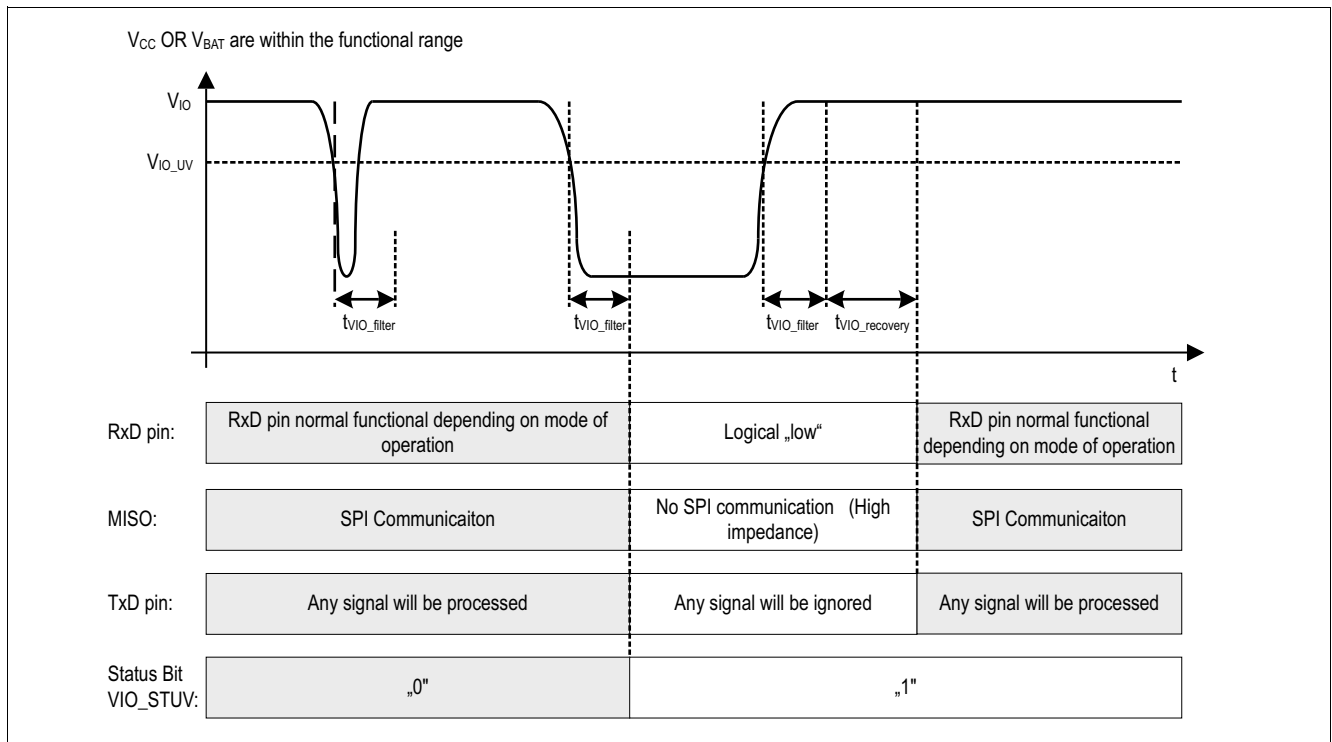

Figure 30 V_{IO} short-term undervoltage detection

Fail Safe Functions

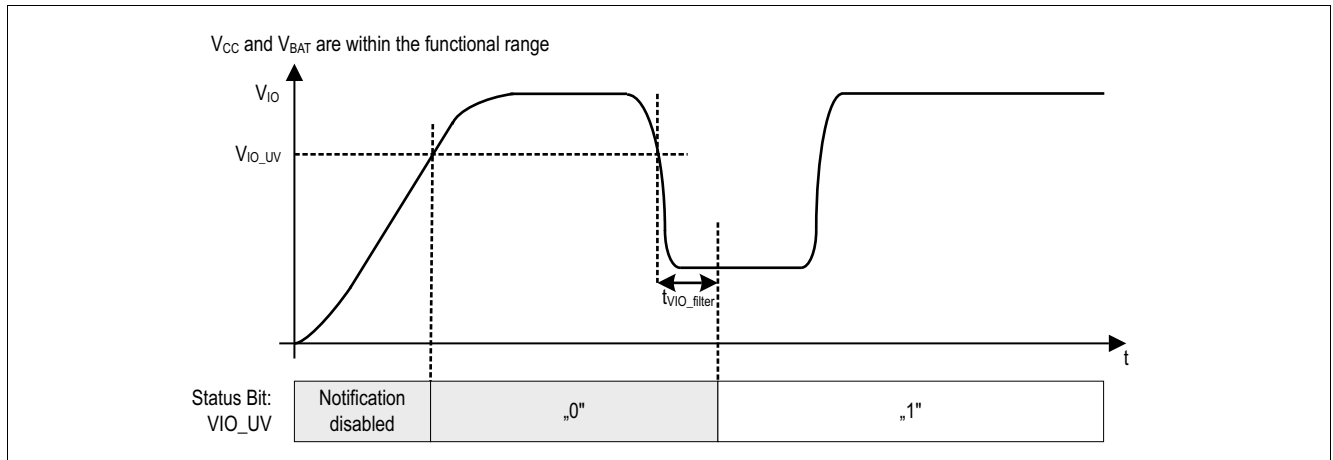

Figure 31 Undervoltage detection V_{IO} during V_{IO} supply stabilization period after Power on Reset

6.2.5 Long-term Undervoltage detection on V_{IO}

If $V_{IO} < V_{IO_UV}$ for more than the glitch filter time t_{VIO_filter} , then the undervoltage detection timer is started. If $t_{VIO_UV_T}$ expires, then a long-term undervoltage is detected. On detection of long-term undervoltage the TLE9255W performs the following actions:

- set the bit **VIO_LTUV** to “1”
- perform a mode change to Sleep WUP Sub-Mode only after $t_{Silence}$ has expired (no bus communication)

If $V_{IO} > V_{IO_UV}$ for more than the glitch filter time t_{VIO_filter} , then the timer $t_{VIO_UV_T}$ is stopped and reset. Only an SPI command can reset the undervoltage bit **VIO_LTUV**. The $t_{VIO_UV_T}$ is configurable in the SPI Register **SUPPLY_CTRL**.

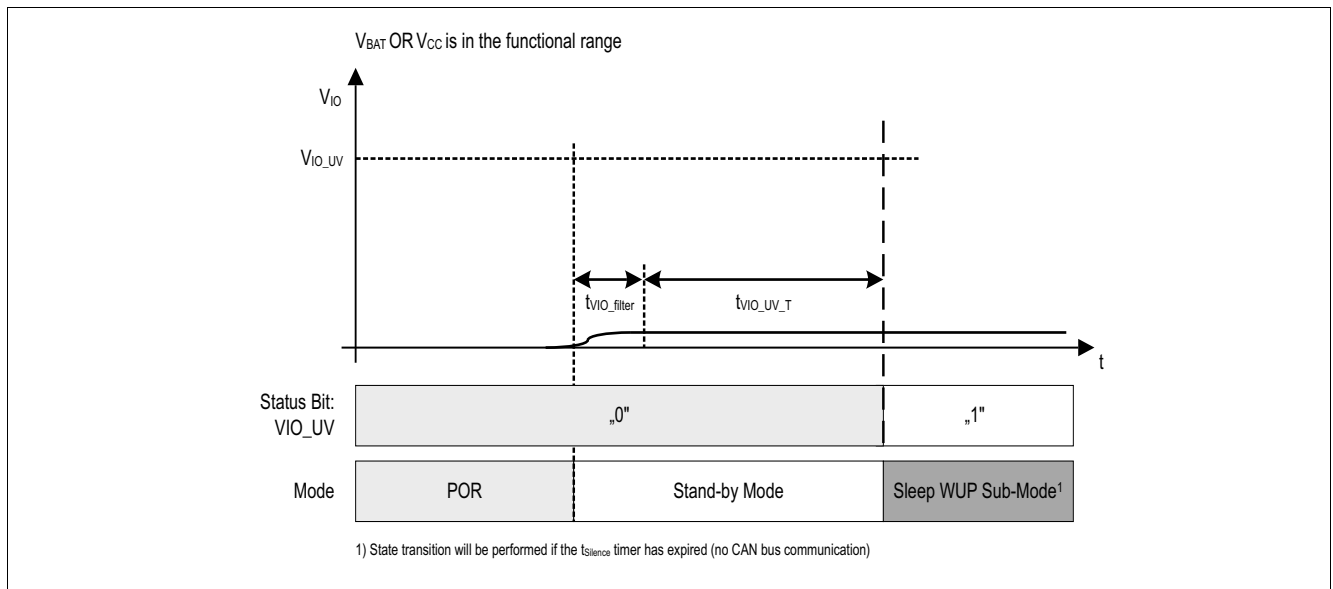

Figure 32 V_{IO} long-term undervoltage detection after power up

Fail Safe Functions

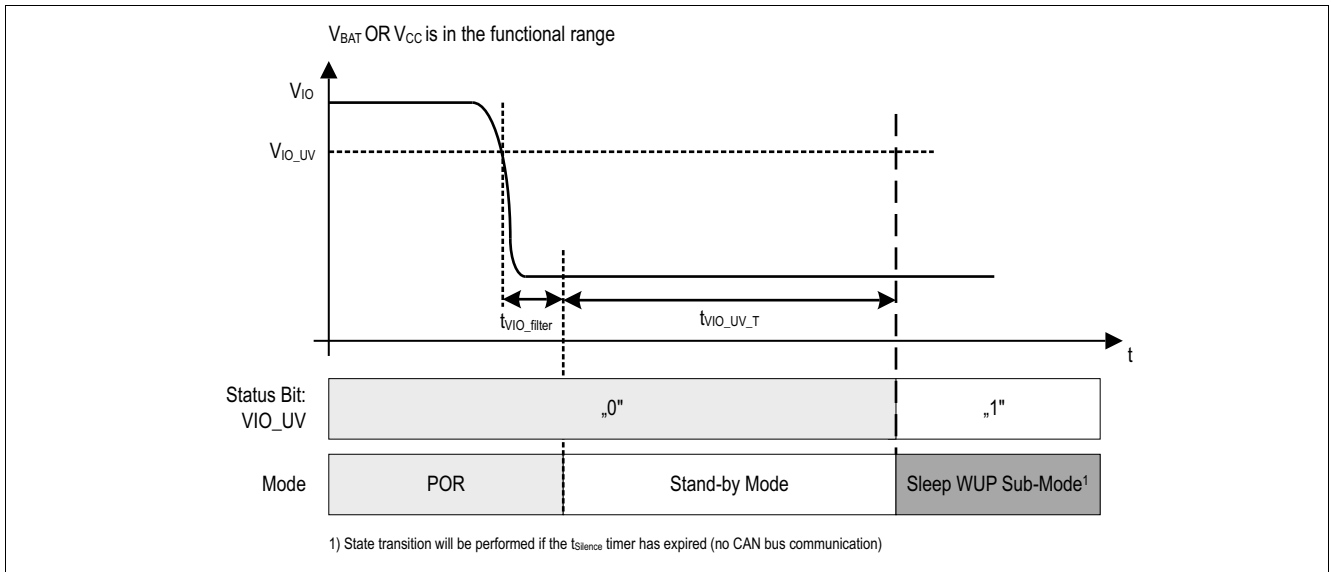

Figure 33 V_{IO} long-term undervoltage detection during operation

6.3 Unconnected Logic Pins

If the input pins are not connected and floating, the integrated pull-up and pull-down resistors at the digital input pins force the TLE9255W into fail safe behavior (see [Table 3](#)).

Table 3 Logical Inputs when unconnected

Input Signal	Default State	Comment
TxD	“high”	pull-up current source to V_{IO}
MOSI	“low”	pull-down current source to GND
SCLK	“low”	pull-down current source to GND
CSN	“high”	pull-up current source to V_{IO}

Fail Safe Functions

6.4 TxD Time-out Function

If the logical signal on the TxD pin is permanently “low”, then the TxD time-out feature protects the CAN bus from blocked communication due to this errant logic signal on TxD. A permanent “low” signal on the TxD pin can occur due to a locked-up microcontroller or in a short circuit on the printed circuit board, for example. In Normal-operating Mode, a “low” signal on the TxD pin for the time $t > t_{\text{TxD_TO}}$ enables the TxD time-out feature and the TLE9255W disables the transmitter (see [Figure 34](#)) and sets the **TXD_TO** bit in the register **TRANS_STAT**. The timer $t_{\text{TxD_TO}}$ is configurable in SPI register **TXD_TO_CTRL**. The receiver is still active and the RxD output pin continues monitoring data on the bus.

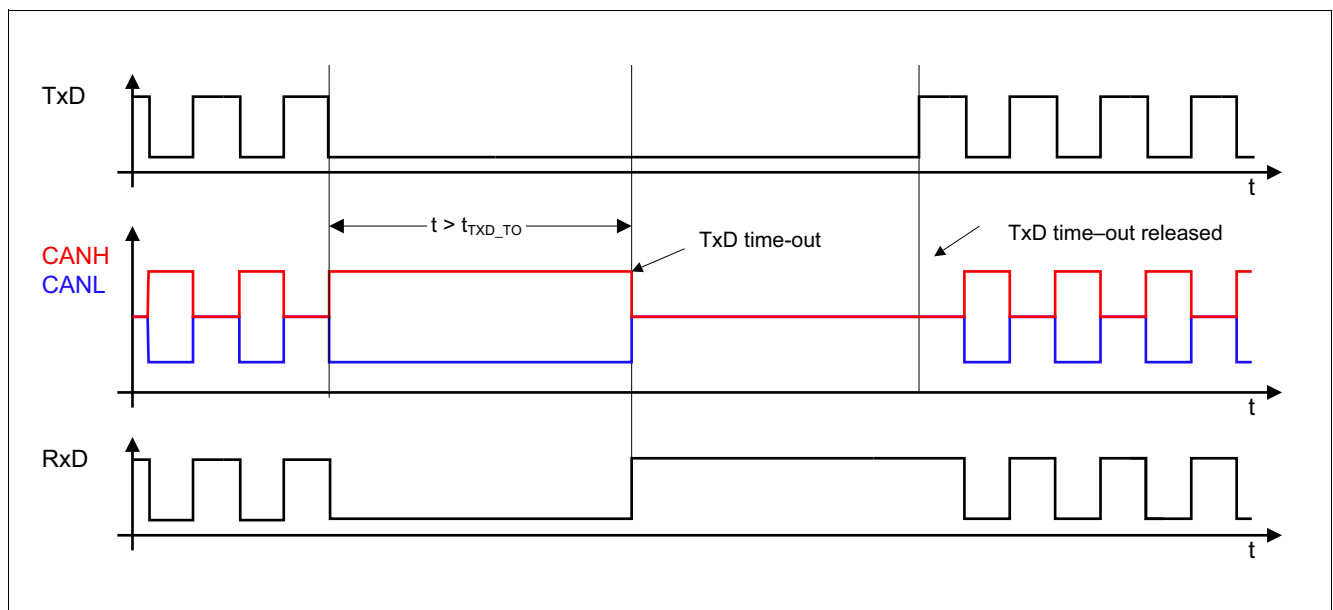

Figure 34 TxD time-out function

Figure 34 shows how the transmitter is deactivated and re-activated. To release the transmitter after a TxD time-out event, the TLE9255W requires a signal change on the TxD input pin from “low” to “high”.

Fail Safe Functions

6.5 Overtemperature Protection

Integrated overtemperature detection protects the TLE9255W from thermal overstress of the transmitter. The overtemperature protection is active in Normal-operating Mode only. The temperature sensor provides the temperature threshold T_{JSD} . If the junction temperature exceeds the upper threshold T_{JSD} , then the TLE9255W disables the transmitter and sets the bit **TSD**, indicating that a critical temperature situation is reached. After the device cools down the transmitter is re-enabled. Only an SPI command can reset the **TSD** bit. A hysteresis is implemented within the temperature sensor.



Figure 35 Overtemperature protection

6.6 Delay Time for Mode Change

The TLE9255W performs mode changes within the time window t_{Mode_Change} . During mode changes (t_{Mode_Change}) the RxD output pin is permanently set to “high” and does not reflect the status on the CANH and CANL input pins. After the mode change is completed, the TLE9255W releases the RxD output pin.

7 CAN Partial Networking

Partial networking allows to exclude nodes from the CAN communication in a CAN network. If the TLE9255W is in the Selective Wake Sub-Mode, then a CAN frame can wake-up the TLE9255W. This feature is called selective wake and the CAN frame is called wake-up frame (WUF). The selective wake unit implements the selective wake feature.

7.1 Wake-up frame evaluation

For a WUF detection the TLE9255W evaluates, whether a received CAN frame is a valid wake-up frame. This wake-up frame evaluation consists of the following parts:

- CAN ID evaluation
- Frame data length code (DLC) and data field evaluation

If both parts are evaluated successfully AND if the CRC of the CAN Frame is valid, then a valid wake-up frame is detected (see [Figure 36](#)). The following chapter describes the process in more detail.

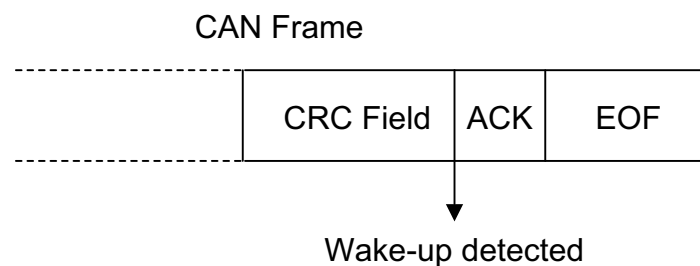

Figure 36 WUF detection

7.1.1 Wake-up frame identifier evaluation

If all relevant CAN ID bits of a CAN frame match the configured CAN ID bits in the TLE9255W, then a valid WUF CAN ID is received. The CAN ID mask excludes CAN ID bits from the evaluation. The CAN ID bits of a received CAN frame are compared bit by bit with the CAN ID configured in register [SWK_ID0_CTRL](#) to [SWK_ID3_CTRL](#). If the received CAN ID is equal to the configured CAN ID, then the wake-up frame identifier evaluation is successful. The CAN ID mask (registers [SWK_MASK_ID0_CTRL](#) to [SWK_MASK_ID3_CTRL](#)) defines which bits the comparison considers. [Figure 37](#) shows an example of the CAN ID evaluation (11 bit CAN ID). The green background color defines the CAN ID bits which are not considered in the comparison.

CAN Partial Networking

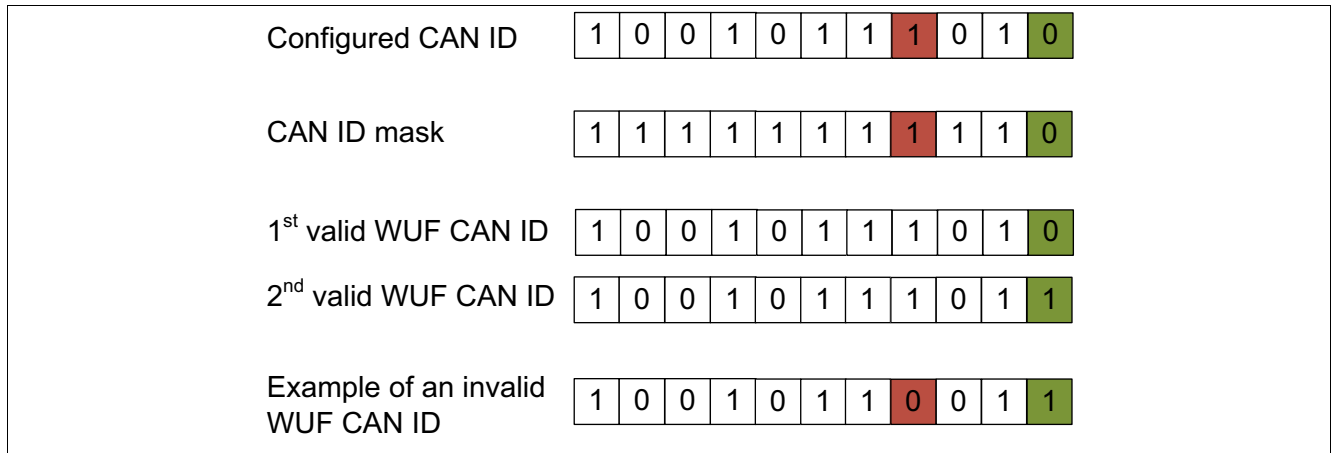

Figure 37 CAN ID and CAN ID mask

The registers **SWK_ID0_CTRL**, **SWK_ID1_CTRL**, **SWK_ID2_CTRL** and **SWK_ID3_CTRL** configure the CAN ID. The **IDE** bit defines the CAN ID format (11 bit or 29 bit identifier).

The registers **SWK_MASK_ID0_CTRL**, **SWK_MASK_ID1_CTRL**, **SWK_MASK_ID2_CTRL** and **SWK_MASK_ID3_CTRL** configure the CAN-ID mask.

7.1.2 DLC and data field evaluation

If all of the following conditions are fulfilled, then the DLC and data field evaluation is successful:

- the DLC of the received CAN frame is equal to the DLC configured in the **DLC** field of the register **SWK_DLC_CTRL**
- At least one bit within the data field of the received CAN frame is “1” and matches to a bit (“1”) of the configured data field. If one bit matches, then the evaluation is stopped. The registers **SWK_DATA0_CTRL**, **SWK_DATA1_CTRL**, **SWK_DATA2_CTRL**, **SWK_DATA3_CTRL**, **SWK_DATA4_CTRL**, **SWK_DATA5_CTRL**, **SWK_DATA6_CTRL** and **SWK_DATA7_CTRL** configure the data field.

Figure 38 shows an example for the data field evaluation. The DLC in this example is 1.

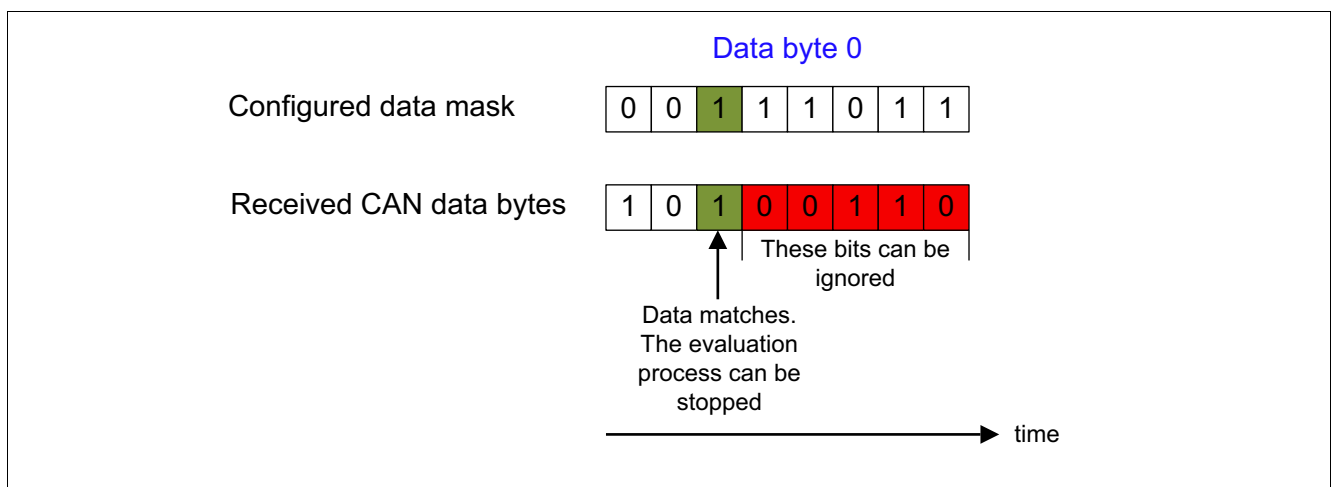

Figure 38 Data field evaluation

CAN Partial Networking

7.2 Activation of Selective Wake

Figure 39 shows the recommended way to activate the selective wake function in the TLE9255W.

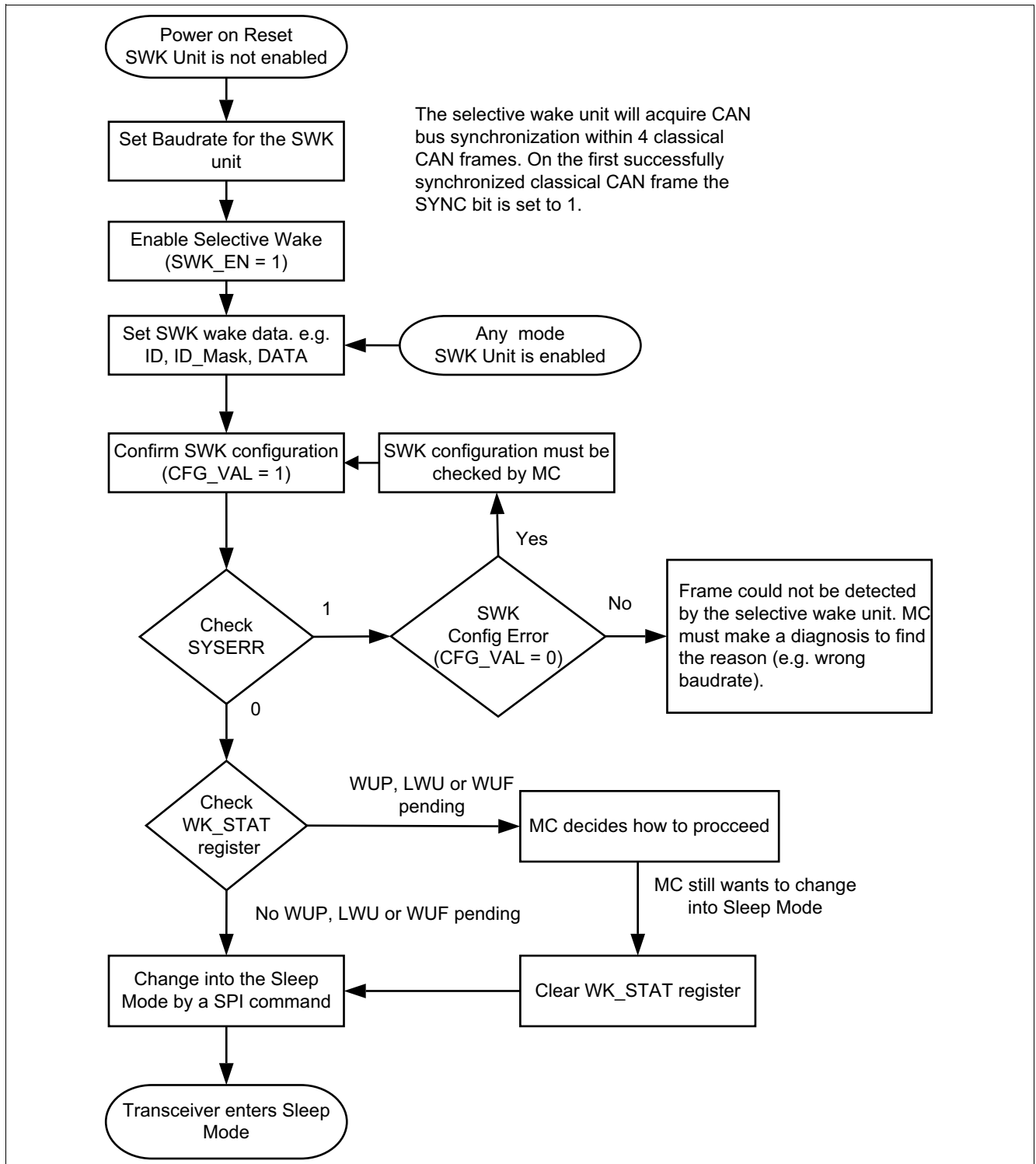

Figure 39 Activation of selective wake function

CAN Partial Networking

7.3 Frame Error Counter

The frame error counter indicates, whether received classical CAN frames are valid. CAN FD frames are not evaluated and therefore CAN FD frame errors do not affect the frame error counter. If the selective wake unit detects a classical CAN frame error, then the frame error counter is increased by 1. If the selective wake unit detects a valid classical CAN frame, then the error counter is decreased by 1. The following types of errors cause invalid classical CAN Frames:

- Bit stuffing error
- CRC error
- CRC delimiter error

If the SPI bit **SWK_EN** = 1, then the frame error counter is active in any mode of operation. The error counter value can be read via SPI (register **SWK_ECNT_STAT**). Each time that the Selective Wake Unit is enabled (**SWK_EN** = 1) OR if the t_{silence} timer has expired, then the error counter is reset to zero.

If the TLE9255W repeatedly receives invalid classical CAN frames in the Selective Wake Sub-Mode, then the frame error counter ensures that a wake-up is performed. If the TLE9255W is in the Selective Wake Sub-Mode and the error counter reaches the value 32, then a wake-up is performed.

7.4 Selective Wake Configuration Error

After the microcontroller has confirmed the configuration (**CFG_VAL** = 1), writing the following registers generates a selective wake configuration error:

- Baudrate control register (**SWK_CTRL_2**)
- Identifier control registers (**SWK_ID3_CTRL**, **SWK_ID2_CTRL**, **SWK_ID1_CTRL** and **SWK_ID0_CTRL**)
- Mask identifier control registers (**SWK_MASK_ID3_CTRL**, **SWK_MASK_ID2_CTRL**, **SWK_MASK_ID1_CTRL** and **SWK_MASK_ID0_CTRL**)
- Data Length control register (**SWK_DLC_CTRL**)
- Data control registers (**SWK_DATA7_CTRL**, **SWK_DATA6_CTRL**, **SWK_DATA5_CTRL**, **SWK_DATA4_CTRL**, **SWK_DATA3_CTRL**, **SWK_DATA2_CTRL**, **SWK_DATA1_CTRL** and **SWK_DATA0_CTRL**)

CAN Partial Networking

The following figure shows a selective wake configuration error.

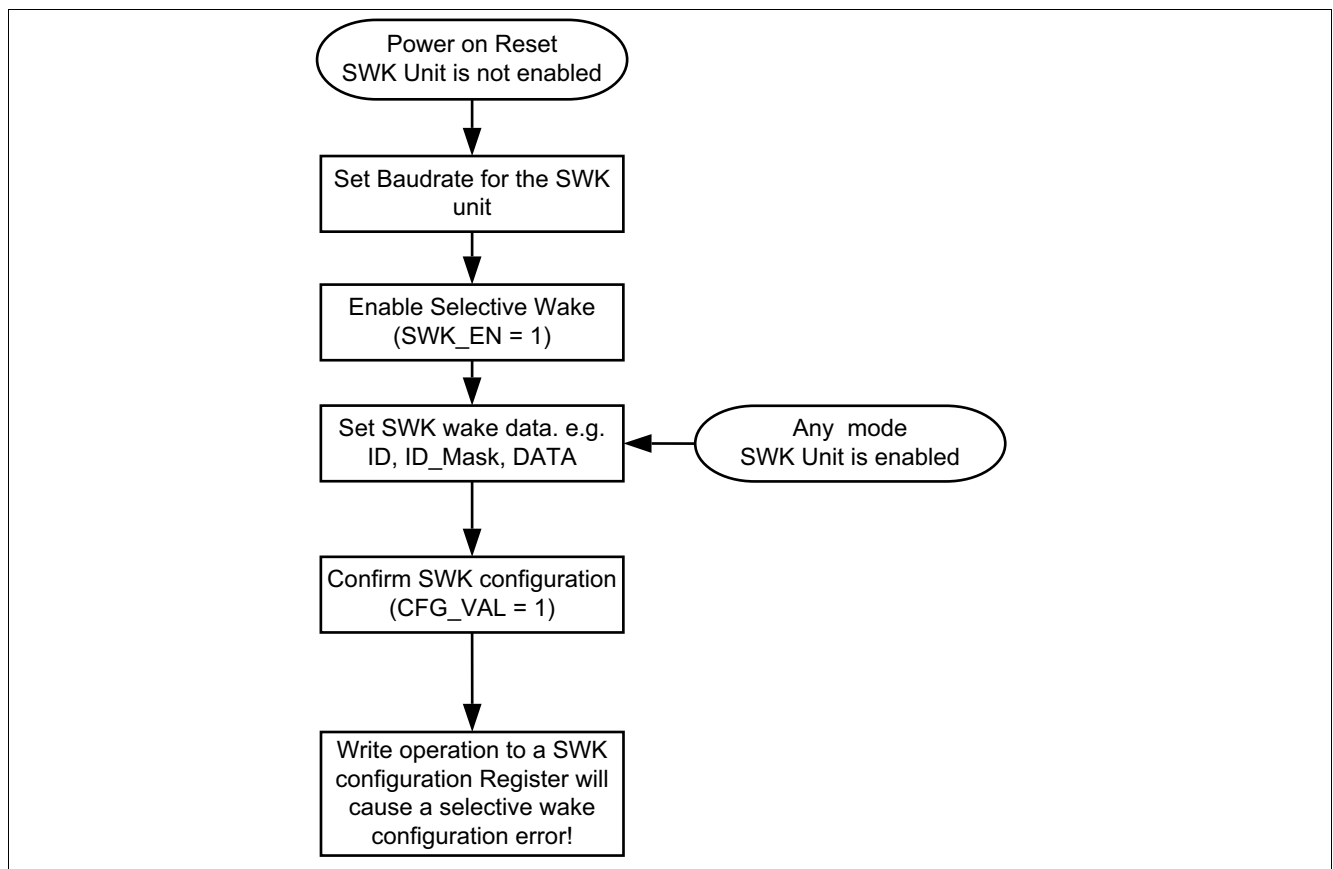

Figure 40 Selective wake configuration Error

7.5 CAN Flexible Data Rate (CAN FD) Tolerant Feature

The CAN FD tolerant feature means that selective wake unit ignores CAN FD frames. Therefore it is not possible to configure a CAN FD frame for wake-up frame (WUF) detection.

At the completion of a detected CAN FD frame, that is, the End of Frame (EOF) is detected, the selective wake unit is ready for detecting the next available classical CAN frame. If at least 6 recessive bits and at most 10 recessive bits are received, then EOF detection is successful. The FDF Bit of the Control Field of a CAN FD frame identifies the type of CAN frame:

- FDF bit = 1:
CAN FD frame recognized, decoding stops
- FDF bit = 0:
classical CAN frame recognized, processing of the frame continues

In this way it is possible to send mixed CAN frame formats without affecting the selective wake functionality by error counter increment and a misleading wake-up. The CAN FD data phase baud rate must be configured in the SPI field **BR_RATIO** of the register **SWK_CTRL_2** to enable detection of CAN FD frames.

7.6 Selective wake SPI flags

7.6.1 SysErr Flag

The **SysErr** flag in the register **SWK_STAT** indicates an error condition in the selective wake unit of the TLE9255W. Only if the SPI bit **SWK_EN** = 1, then the **SysErr** flag is set. The **SysErr** flag does not prevent entering the Sleep Mode by an SPI command. However, the **SysErr** flag determines, whether the TLE9255W enters the Selective Wake Sub-Mode (**SysErr** = 0) or Sleep WUP Mode (**SysErr** = 1). **Figure 41** shows this scenario.

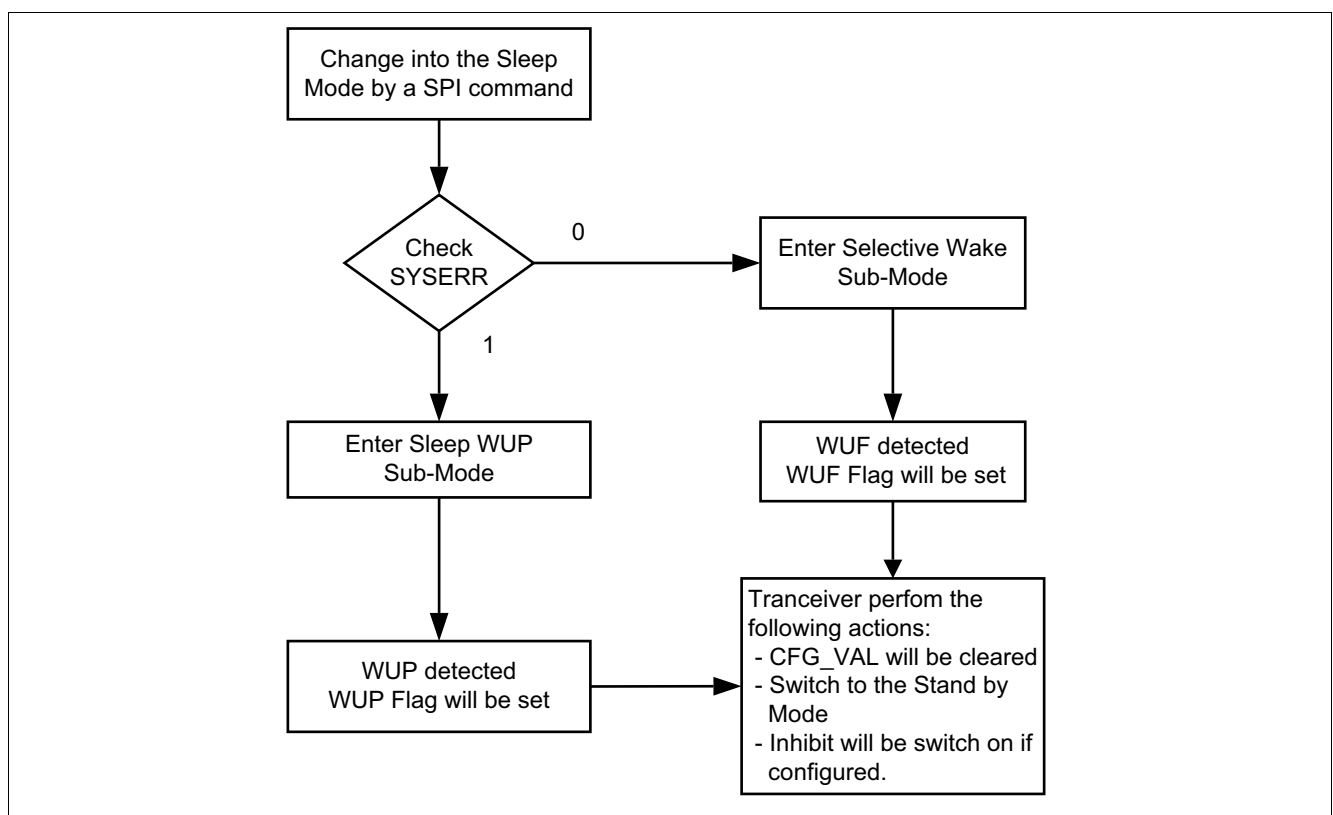

Figure 41 Impact of SysErr flag if a mode change SPI command to Sleep Mode has been sent

The **SysErr** flag is set under any of the following conditions:

- Selective wake configuration error is detected (see **Chapter 7.4**).
- The frame error counter value is greater than 31.

Only if no configuration error (**CFG_VAL** = 1) exists AND if the error counter is less than 32, then the TLE9255W resets the **SysErr** flag.

7.6.2 SYNC Flag

The **SYNC** flag in the register **SWK_STAT** indicates that a classical CAN frame is detected correctly by the selective wake unit. The **SYNC** flag works, if all of the following conditions are fulfilled:

- Selective Wake is enabled (**SWK_EN** Bit = 1)
- After Power on Reset the configuration is confirmed (**CFG_VAL** Bit = 1) at least once.

CAN Partial Networking

If the selective wake unit detects an invalid classical CAN frame, then the **SYNC** flag is reset. The **SYNC** flag has no influence on the transition to the Sleep Mode by an SPI command. After power up **SYNC** = 0. The **SYNC** flag is not valid in the Selective Sleep Sub-Mode.

7.6.3 CANTO Flag

The **CANTO** flag in the register **SWK_STAT** indicates that the TLE9255W has entered Selective Sleep Mode (no bus communication) at least once. Only if the SPI bit **SWK_EN** = 1, then the **CANTO** flag can be set. If the TLE9255W is in the Selective Sleep Mode AND if the t_{Silence} timer expires, then the **CANTO** flag is set. Only an SPI command can reset the **CANTO** flag.

7.6.4 CANSIL Flag

The **CANSIL** flag in the register **SWK_STAT** indicates that there is no communication on the CAN bus (t_{Silence} timer has expired). **Figure 15** defines the restart conditions for the t_{Silence} timer.

7.6.5 SWK_ACTIVE Flag

The **SWK_ACTIVE** flag in the register **SWK_STAT** indicates that the TLE9255W is in Selective Wake Sub-Mode. If the TLE9255W enters the Selective Wake Sub-Mode, then the **SWK_ACTIVE** flag is set. If the TLE9255W exits Sleep Mode, then it resets the **SWK_ACTIVE** flag.

7.6.6 CFG_VAL Flag

The microcontroller sets the **CFG_VAL** flag in the register **SWK_CTRL_1** to confirm the selective wake configuration. This confirmation must be performed each time before a mode change to Sleep Mode by an SPI command (Selective Wake Sub-Mode) is sent. The TLE9255W resets the **CFG_VAL** bit under any of the following conditions:

- If a mode change from Selective Wake Sub-Mode to Stand-by Mode is performed.
- If a mode change from Selective Sleep Sub-Mode to Stand-by Mode is performed.
- If a selective wake configuration error is detected (**Chapter 7.4**).

Serial Peripheral Interface

8 Serial Peripheral Interface

The communication between the microcontroller and the transceiver is implemented via Serial Peripheral Interface (SPI). This communication is configured as a full duplex multi slave data transfer. A valid SPI command consists of 16 bits.

Only if $V_{IO} > V_{IO_UV}$ AND if V_{BAT} OR V_{CC} is within the functional range, then SPI communication between the microcontroller and the transceiver can be established. The SPI uses four interface signals for synchronization and data transfer:

- CSN: SPI chip select (active low)
- SCLK: SPI clock
- MOSI: SPI data input
- MISO: SPI data output

Figure 42 shows the SPI data transfer.

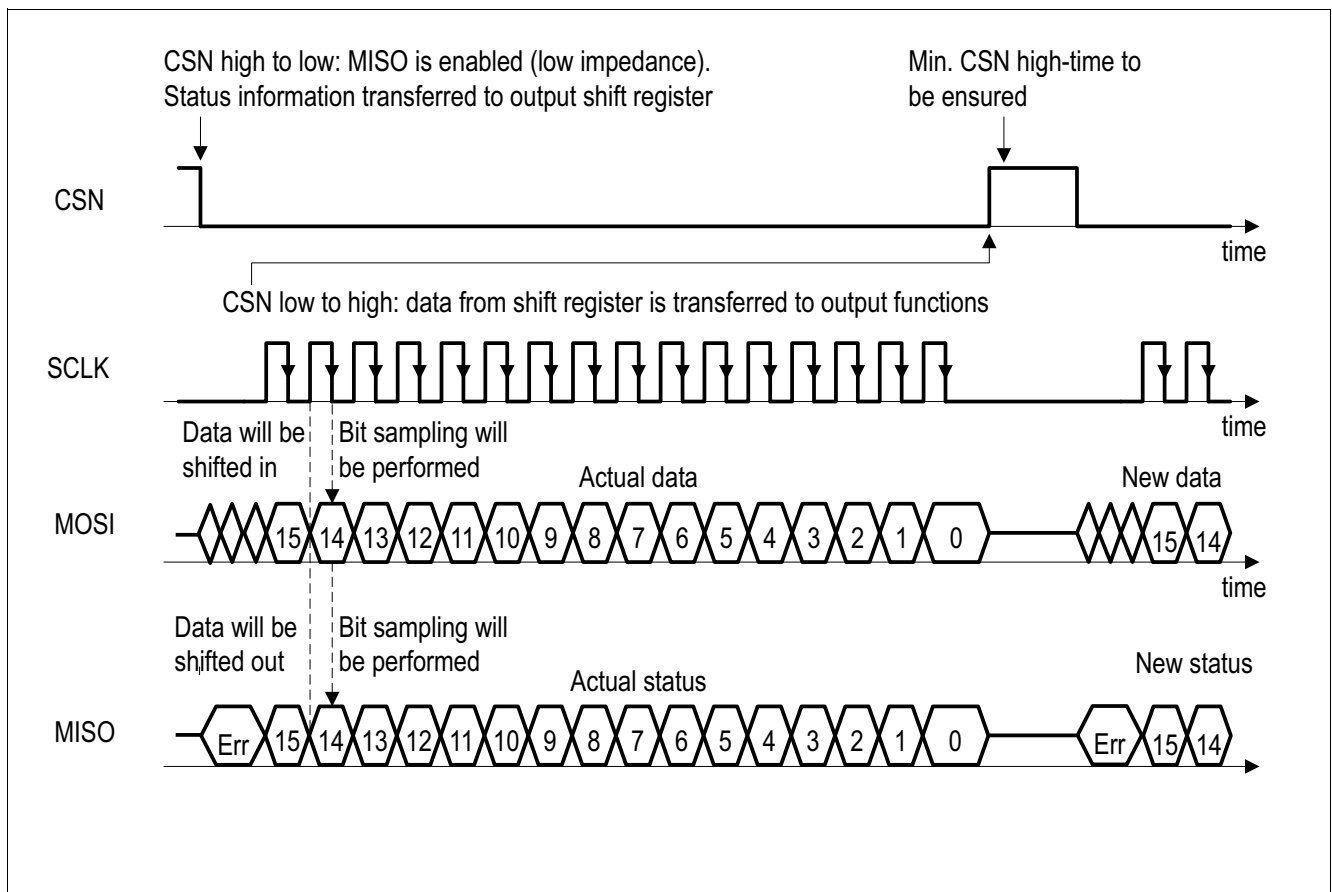

Figure 42 SPI Data Transfer

The SPI command transmission cycle begins when the transceiver is selected by the CSN pin (active low). When the signal of the CSN input pin returns from “low” to “high”, the TLE9255W decodes the data that was shifted in on the MOSI. The data of MOSI and MISO is shifted in and out (MSB comes first) on every rising edge of SCLK. The bit sampling is performed on every falling edge of SCLK. If the CSN input pin is “high”, then the MISO pin has a high impedance. The SPI of the transceiver does not support TLE9255W daisy chaining. The MISO pin signals invalid SPI commands ([Chapter 8.5](#)) or SPI failures ([Chapter 8.4](#)). If an invalid SPI

Serial Peripheral Interface

command OR an SPI failure occurs, then the MISO pin is “high” after the CSN pin is “low” and before a clock starts. [Chapter 8.4](#) defines the conditions for an SPI Error.

8.1 SPI command format

An SPI command consists of:

- MOSI request format
- MISO response format

[Figure 43](#) shows the SPI command format.

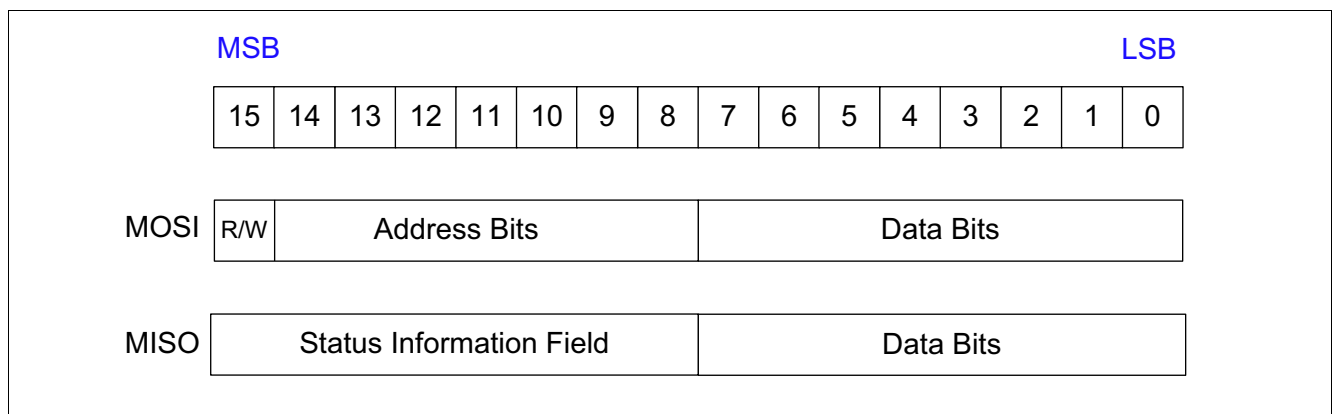

Figure 43 Command Format of the MOSI and MISO register

MOSI Format Frame

The MOSI format frame consists of address bits (Bits 14-8) and data bits (Bits 7-0). The R/W bit (Bit15) defines a write operation (R/W = 1) or a read (R/W = 0) operation to the addressed register. For read operations the data bits are not relevant.

MISO Format Frame

The MISO format frame consists of the status information field (Bits 15-8) and the data bits (Bits 7-0). The data bits contain the data of the addressed register. The status information field contains compressed information about the Status Register ([Chapter 8.3](#)).

Serial Peripheral Interface

8.2 Control and Status Register

There are two types of registers:

- Control registers:
Control the behavior of the TLE9255W, for example mode change and selective wake configuration.
- Status registers:
Status registers represent the status of the TLE9255W, for example wake events and failures. The TLE9255W controls the bits of the status register. However, the microcontroller must reset some of these bits. Writing “1” clears the register (w1c). In case of reading the register the address bits for the register must be set, the R/W bit must be set to 0 and the data bits are not relevant. Writing a “1” to the specific bits in the status register resets the status bits in the status register. **Figure 44** shows this scenario.

	R/W	Address Bits								Data Bits						
Status Register	-	0	0	1	1	0	0	1	1	1	1	1	0	1	1	1
SPI Command	1	0	0	1	1	0	0	1	0	1	1	0	0	0	0	0
Status Register after SPI Command	-	0	0	1	1	0	0	1	1	0	0	1	0	1	1	1

Figure 44 Read and clear command

Serial Peripheral Interface

8.3 Status Information Field

The Status Information Field informs the microcontroller that status register bits have changed. The Status Information Field is returned during each SPI write or read command in the MISO format frame. Each bit of the Status Information Field represents an OR operation of some bits of a specific status register. If an SPI access occurs while the status register is being updated due to an event, the content of the Status Information Field may not reflect the latest state of the status registers. **Table 4** defines the content of the Status Information Field.

Table 4 Status Information Field

Name	Bit Position	Reflected Bits
Reserved	0	-
TRANS_UV_STAT (Transceiver undervoltage status)	1	VBAT_UV OR VCC_LTUV OR VCC_STUV OR VIO_LTUV OR VIO_STUV
TEMP_STAT (Temperature status)	2	TSD OR Reserved
WAKE_STAT (Wake-up status)	3	LWU OR WUP OR WUF
TXD_TO (TxD timeout)	4	TXD_TO
CANSIL (CAN Silence)	5	CANSIL
POR (Power on Reset)	6	POR
ERR_STAT (Error status)	7	CMD_ERR or COM_ERR

The ERR_STAT is flagged on the MISO pin.

8.4 SPI Failure

The SPI bit **COM_ERR** signals an SPI failure. Any of the following conditions define the SPI failure:

- Register address does not exist
- Number of received SPI clocks is neither 0 nor 16

On SPI failure SPI commands are ignored.

8.5 Invalid SPI Command

Any attempt to write undefined bit combinations to one of the following SPI registers is an invalid SPI command.

- **Mode** of the register **MODE_CTRL**
- **TXD_TO** of the register **TXD_TO_CTRL**
- **BR_RATIO** of the register **SWK_CTRL_2**
- **BR** of the register **SWK_CTRL_2**
- **VIO_UV_T** of the register **SUPPLY_CTRL**
- **VCC_UV_T** of the register **SUPPLY_CTRL**

An invalid SPI command is ignored and the **CMD_ERR** bit is set and signalled on the MISO pin. Only the microcontroller can reset the **CMD_ERR** bit.

Serial Peripheral Interface

8.6 CSN Timeout

The CSN timeout (t_{CSN_TO}) prevents the SPI communication from disturbance. After the CSN pin of the TLE9255W is set to “low” (start of the SPI communication and t_{CSN_TO}) the communication must be finished and the CSN pin must be set to “high” within t_{CSN_TO} . If the t_{CSN_TO} timeout occurs, then the TLE9255W sets the MISO pin to high impedance. If the CSN pin is set to “high”, then the t_{CSN_TO} is reset. **Figure 45** shows this scenario.

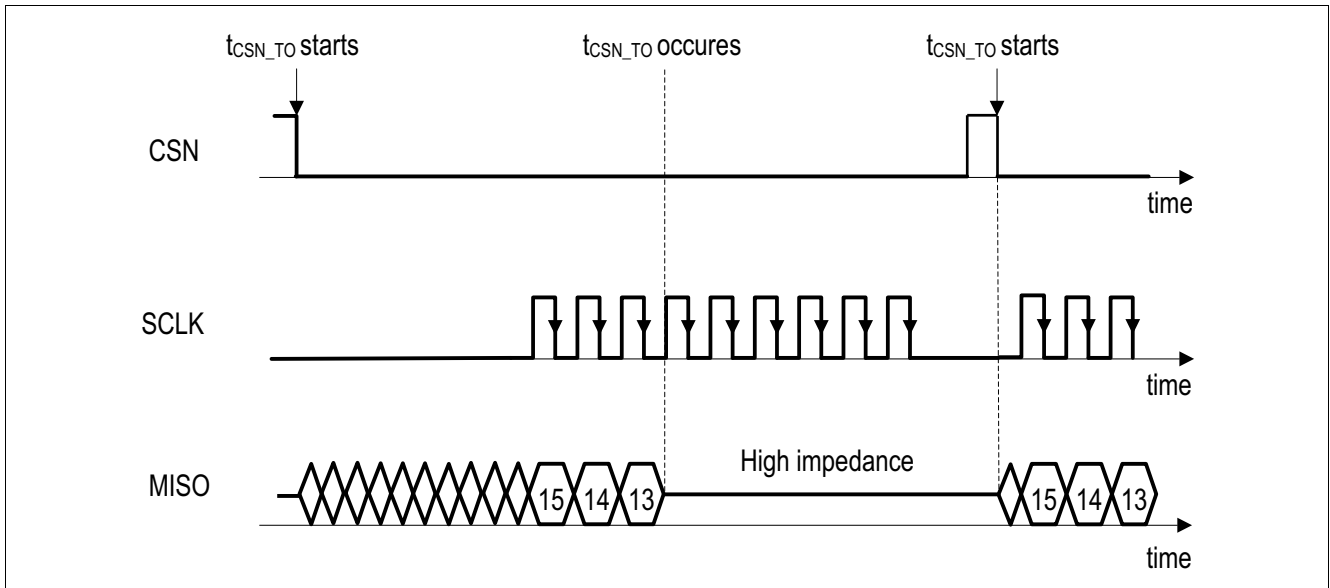

Figure 45 CSN Timeout

8.7 SPI Register

The following figure gives an overview of the SPI register.

Serial Peripheral Interface

Register Short Name	7	6	5	4	3	2	1	0	15	14...8
	Data Bit 15...8								Access Mode	Address A14...A8
	D7	D6	D5	D4	D3	D2	D1	D0		
CONTROL REGISTERS										
MODE_CTRL	reserved	reserved	reserved	reserved	reserved	reserved	reserved	Mode	read/write	0000001
HW_CTRL	STTS_EN	LWU_NEG	LWU_POS	reserved	reserved	reserved	WAKE_TOG	VBAT_CON	read/write	0000010
TXD_TO_CTRL	reserved	reserved	reserved	reserved	reserved	TXD_TO_2	TXD_TO_1	TXD_TO_0	read/write	0000011
SUPPLY_CTRL	VIO_UV_T_3	VIO_UV_T_2	VIO_UV_T_1	VIO_UV_T_0	VCC_UV_T_3	VCC_UV_T_2	VCC_UV_T_1	VCC_UV_T_0	read/write	0000100
SELECTIVE WAKE REGISTERS										
SWK_CTRL_1	reserved	reserved	reserved	reserved	reserved	reserved	reserved	CFG_VAL	read/write	0000101
SWK_CTRL_2	SWK_EN	reserved	BR_RATIO_1	BR_RATIO_0	reserved	BR_2	BR_1	BR_0	read/write	0000110
SWK_ID3_CTRL	reserved	reserved	IDE	IDE28/ID10	IDE27/ID9	IDE26/ID8	IDE25/ID7	IDE24/ID6	read/write	0000111
SWK_ID2_CTRL	IDE23/ID5	IDE22/ID4	IDE21/ID3	IDE20/ID2	IDE19/ID1	IDE18/ID0	IDE17	IDE16	read/write	0001000
SWK_ID1_CTRL	IDE15	IDE14	IDE13	IDE12	IDE11	IDE10	IDE9	IDE8	read/write	0001001
SWK_ID0_CTRL	IDE7	IDE6	IDE5	IDE4	IDE3	IDE2	IDE1	IDE0	read/write	0001010
SWK_MASK_ID3_CTRL	reserved	reserved	reserved	MASK_ID28	MASK_ID27	MASK_ID26	MASK_ID25	MASK_ID24	read/write	0001011
SWK_MASK_ID2_CTRL	MASK_ID23	MASK_ID22	MASK_ID21	MASK_ID20	MASK_ID19	MASK_ID18	MASK_ID17	MASK_ID16	read/write	0001100
SWK_MASK_ID1_CTRL	MASK_ID15	MASK_ID14	MASK_ID13	MASK_ID12	MASK_ID11	MASK_ID10	MASK_ID9	MASK_ID8	read/write	0001101
SWK_MASK_ID0_CTRL	MASK_ID7	MASK_ID6	MASK_ID5	MASK_ID4	MASK_ID3	MASK_ID2	MASK_ID1	MASK_ID0	read/write	0001110
SWK_DLC_CTRL	reserved	reserved	reserved	reserved	DLC_3	DLC_2	DLC_1	DLC_0	read/write	0001111
SWK_DATA7_CTRL	DATA7_7	DATA7_6	DATA7_5	DATA7_4	DATA7_3	DATA7_2	DATA7_1	DATA7_0	read/write	0010000
SWK_DATA6_CTRL	DATA6_7	DATA6_6	DATA6_5	DATA6_4	DATA6_3	DATA6_2	DATA6_1	DATA6_0	read/write	0010001
SWK_DATA5_CTRL	DATA5_7	DATA5_6	DATA5_5	DATA5_4	DATA5_3	DATA5_2	DATA5_1	DATA5_0	read/write	0010010
SWK_DATA4_CTRL	DATA4_7	DATA4_6	DATA4_5	DATA4_4	DATA4_3	DATA4_2	DATA4_1	DATA4_0	read/write	0010011
SWK_DATA3_CTRL	DATA3_7	DATA3_6	DATA3_5	DATA3_4	DATA3_3	DATA3_2	DATA3_1	DATA3_0	read/write	0010100
SWK_DATA2_CTRL	DATA2_7	DATA2_6	DATA2_5	DATA2_4	DATA2_3	DATA2_2	DATA2_1	DATA2_0	read/write	0010101
SWK_DATA1_CTRL	DATA1_7	DATA1_6	DATA1_5	DATA1_4	DATA1_3	DATA1_2	DATA1_1	DATA1_0	read/write	0010110
SWK_DATA0_CTRL	DATA0_7	DATA0_6	DATA0_5	DATA0_4	DATA0_3	DATA0_2	DATA0_1	DATA0_0	read/write	0010111
STATUS REGISTERS										
TRANS_STAT	POR	reserved	reserved	reserved	reserved	TXD_TO	TSD	reserved	read/clear	0011000
TRANS_UV_STAT	VBAT_UV	reserved	VCC_LTUV	VCC_STUV	reserved	reserved	reserved	VIO_LTUV	read/clear	0011001
ERR_STAT	reserved	reserved	reserved	reserved	reserved	reserved	reserved	COM_ERR	read/clear	0011010
WAKE_STAT	reserved	reserved	reserved	reserved	LWU_DIR	LWU	WUP	WUF	read/clear	0011011
SELECTIVE WAKE STATUS REGISTERS										
SWK_STAT	reserved	reserved	reserved	SYSERR	SYNC	CANTO	CANSIL	SWK_ACTIVE	read	0011100
SWK_ECNT_STAT	reserved	reserved	ECNT_5	ECNT_4	ECNT_3	ECNT_2	ECNT_1	ECNT_0	read	0011101

Figure 46 Register overview

Serial Peripheral Interface

8.7.1 Mode Control Register

MODE_CTRL

Mode Control

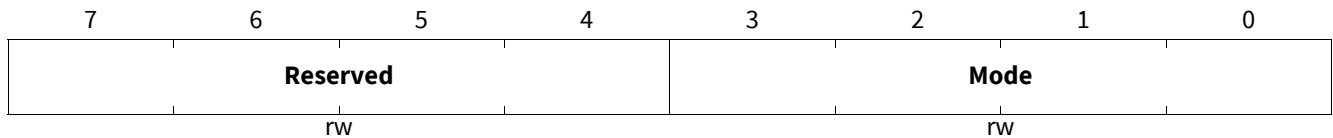
(01_H)Reset Value:0002_H

Field	Bits	Type	Description
Reserved	7:4	rw	Reserved
Mode	3:0	rw	Mode¹⁾²⁾ 0001 _B , Sleep Mode 0010 _B , Standby Mode 0100 _B , Receive Only Mode 1000 _B , Normal Operation Mode

1) Internal state transitions have higher priority than mode change SPI commands

2) The Mode bits are a reflection of the state of the transceiver which includes internal state transitions

HW_CTRL

Hardware Control

(02_H)Reset Value:00E1_H

Field	Bits	Type	Description
STTS_EN	7	rw	State transition to Sleep WUP Sub-Mode if a $V_{CC} < V_{CC_UV}$ AND $t > t_{VCC_UV_T}$ AND $t_{Silence}$ has expired 0 _B , State transition will not be performed 1 _B , State transition will be performed
LWU_NEG	6	rw	Local wake-up direction 0 _B , Local wake-up will not be performed on the negative edge 1 _B , Local wake-up will be performed on the negative edge
LWU_POS	5	rw	Local wake-up direction 0 _B , Local wake-up will not be performed on the positive edge 1 _B , Local wake-up will be performed on the positive edge
Reserved	4:2	rw	Reserved
WAKE_TOG	1	rw	Toggle RxD Pin if a wake-up event is detected 0 _B , The RxD Pin will be constant “low” 1 _B , The RxD Pin will toggle between “low” and “high”

Serial Peripheral Interface

Field	Bits	Type	Description
VBAT_CON	0	rw	<p>Transceiver is connected with the battery</p> <p>0_B , INH pin will not be switched off by entering the sleep mode, V_{BAT_UV} is disabled LWU is disabled</p> <p>1_B , INH pin will be switched off by entering the sleep mode V_{BAT_UV} is enabled LWU is enabled</p>

Serial Peripheral Interface

TXD_TO_CTRL

TXD Timeout Control

(03_H)

Reset Value:0001_H

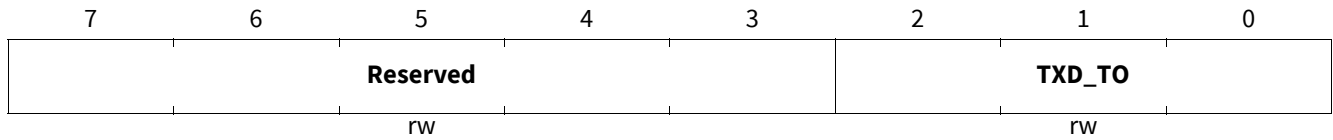

Field	Bits	Type	Description
Reserved	7:3	rw	Reserved
TXD_TO	2:0	rw	TXD Timeout (min - max) 001 _B , 1 - 4 ms 010 _B , 2 - 8 ms 011 _B , 5 - 10 ms 100 _B , disabled

SUPPLY_CTRL

Supply Control

(04_H)

Reset Value:00CC_H

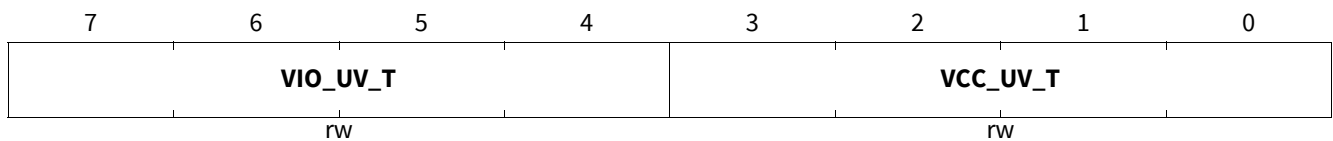

Field	Bits	Type	Description
VIO_UV_T	7:4	rw	VIO Undervoltage Detection Timer¹⁾ 0001 _B , 100 ms 0010 _B , 200 ms 0011 _B , 300 ms 0100 _B , 400 ms 0101 _B , 500 ms 0110 _B , 600 ms 0111 _B , 700 ms 1000 _B , 800 ms 1001 _B , 900 ms 1010 _B , 1000 ms 1011 _B , 1100 ms 1100 _B , 1200 ms 1101 _B , 1300 ms 1110 _B , 1400 ms 1111 _B , 1500 ms

Serial Peripheral Interface

Field	Bits	Type	Description
VCC_UV_T	3:0	rw	VCC Undervoltage Detection Timer¹⁾ 0001 _B , 100 ms 0010 _B , 200 ms 0011 _B , 300 ms 0100 _B , 400 ms 0101 _B , 500 ms 0110 _B , 600 ms 0111 _B , 700 ms 1000 _B , 800 ms 1001 _B , 900 ms 1010 _B , 1000 ms 1011 _B , 1100 ms 1100 _B , 1200 ms 1101 _B , 1300 ms 1110 _B , 1400 ms 1111 _B , 1500 ms

1) The derivation of the value can be +/- 40%

Serial Peripheral Interface

8.7.2 Selective Wake Control Register

SWK_CTRL_1

Selective Wake Control

(05_H)

Reset Value: 0000_H

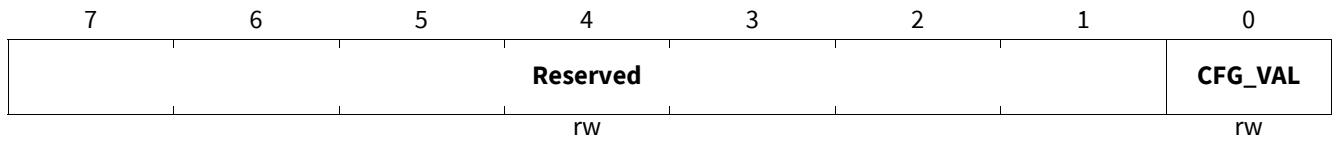

Field	Bits	Type	Description
Reserved	7:1	rw	Reserved
CFG_VAL	0	rw	Selective Wake Configuration valid 0 _B , Invalid 1 _B , Valid

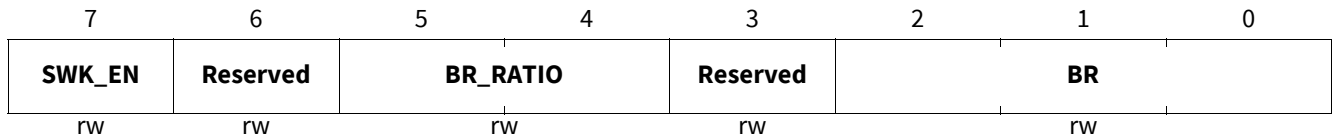
Serial Peripheral Interface
SWK_CTRL_2**Baudrate Control****(06_H)****Reset Value:0004_H**

Field	Bits	Type	Description
SWK_EN	7	rw	Selective Wake Unit 0 _B , Disabled 1 _B , Enabled
Reserved	6	rw	Reserved
BR_RATIO	5:4	rw	Baudrate ratio from arbitration phase to CAN FD data phase 00 _B , Ratio <= 4 01 _B , Ratio <= 10
Reserved	3	rw	Reserved
BR	2:0	rw	Selective Wake Unit Baudrate 010 _B , 125 kbit/s ¹⁾ 011 _B , 250 kbit/s 100 _B , 500 kbit/s 101 _B , 1 Mbit/s

1) Glitch filter time is 300 ns in case of ratio 4

Serial Peripheral Interface

SWK_ID3_CTRL

Identifier 3 Control

(07_H)

Reset Value: 001F_H

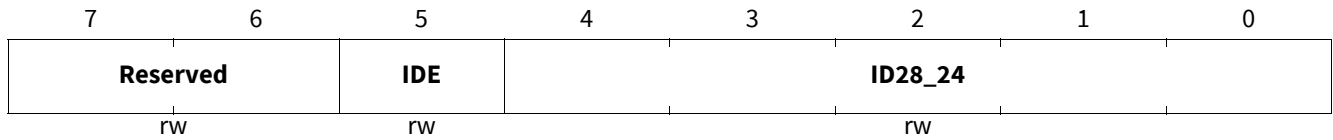

Field	Bits	Type	Description
Reserved	7:6	rw	Reserved
IDE	5	rw	Identifier Type 0 _B , Normal Identifier 1 _B , Extended Identifier
ID28_24	4:0	rw	Wake-up frame Identifier <i>Note: If a normal Identifier is configured (IDE = 0) the bits ID28 - ID24 define the normal identifier bits ID10 - ID6</i>

SWK_ID2_CTRL

Identifier 2 Control

(08_H)

Reset Value: 00FF_H

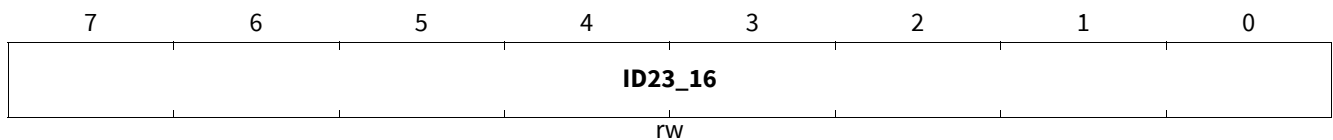

Field	Bits	Type	Description
ID23_16	7:0	rw	Wake-up frame Identifier <i>Note: If a normal Identifier is configured (IDE = 0) the bits ID23 - ID18 define the normal identifier bits ID5 - ID0</i>

SWK_ID1_CTRL

Identifier 1 Control

(09_H)

Reset Value: 00FF_H

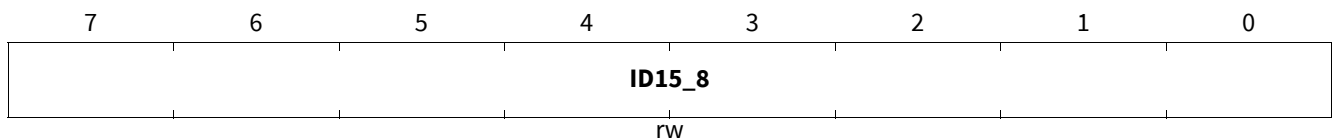

Field	Bits	Type	Description
ID15_8	7:0	rw	Wake-up frame Identifier

Serial Peripheral Interface

SWK_ID0_CTRL

Identifier 0 Control

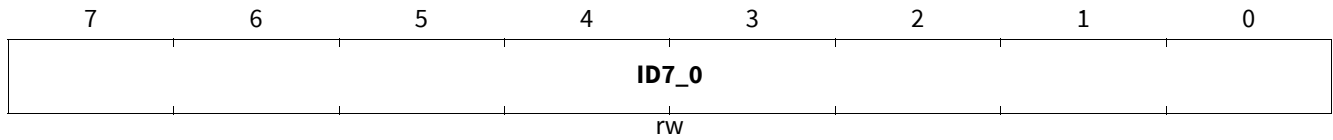
(0A_H)Reset Value: 00FF_H

Field	Bits	Type	Description
ID7_0	7:0	rw	Wake-up frame Identifier

SWK_MASK_ID3_CTRL

Mask Identifier 3 Control

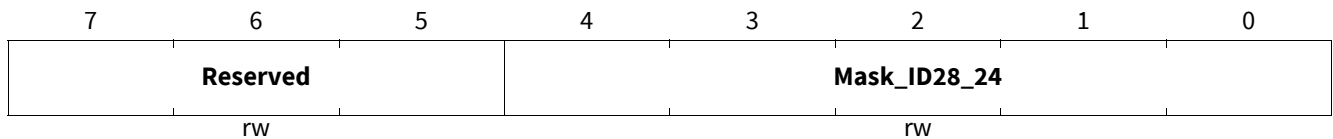
(0B_H)Reset Value: 0000_H

Field	Bits	Type	Description
Reserved	7:5	rw	Reserved
Mask_ID28_24	4:0	rw	Mask Identifier

SWK_MASK_ID2_CTRL

Mask Identifier 2 Control

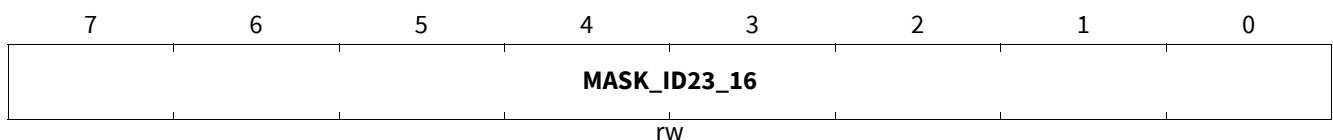
(0C_H)Reset Value: 0000_H

Field	Bits	Type	Description
MASK_ID23_16	7:0	rw	Mask Identifier

SWK_MASK_ID1_CTRL

Mask Identifier 1 Control

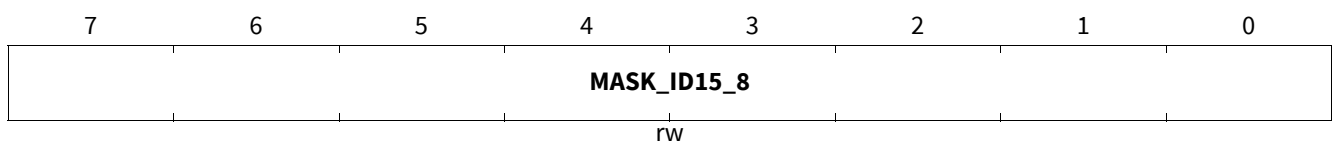
(0D_H)Reset Value: 0000_H

Field	Bits	Type	Description
MASK_ID15_8	7:0	rw	Mask Identifier

Serial Peripheral Interface

SWK_MASK_ID0_CTRL

Mask Identifier 0 Control

(0E_H)

Reset Value: 0000_H

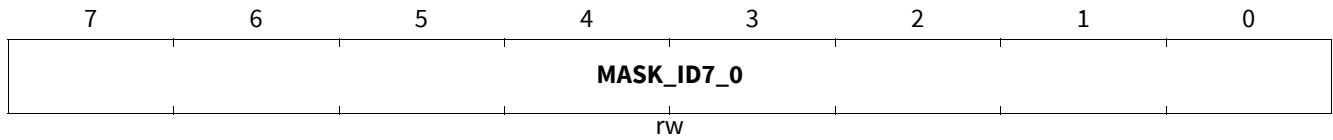

Field	Bits	Type	Description
MASK_ID7_0	7:0	rw	Mask Identifier

SWK_DLC_CTRL

Data Length Code Control

(0F_H)

Reset Value: 0000_H

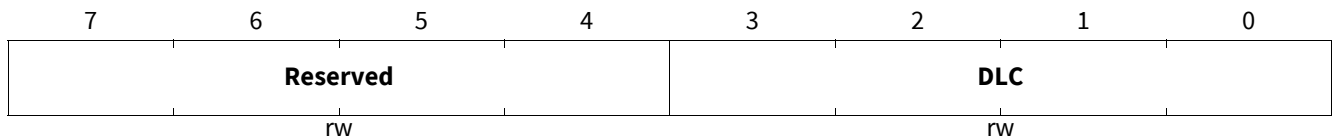

Field	Bits	Type	Description
Reserved	7:4	rw	Reserved
DLC	3:0	rw	Data Length Code 0000 _B , 0 Data Bytes 0001 _B , 1 Data Bytes 0010 _B , 2 Data Bytes 0011 _B , 3 Data Bytes 0100 _B , 4 Data Bytes 0101 _B , 5 Data Bytes 0110 _B , 6 Data Bytes 0111 _B , 7 Data Bytes 1000 _B , 8 Data Bytes 1001 _B , 8 Data Bytes 1010 _B , 8 Data Bytes 1011 _B , 8 Data Bytes 1100 _B , 8 Data Bytes 1101 _B , 8 Data Bytes 1110 _B , 8 Data Bytes 1111 _B , 8 Data Bytes

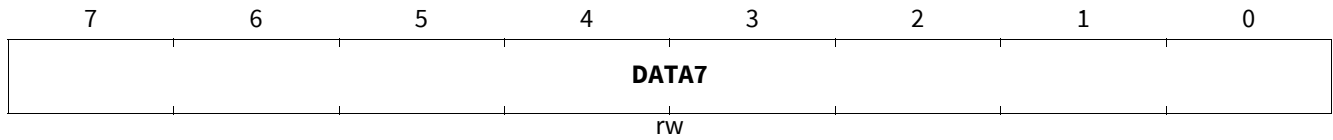
Serial Peripheral Interface
SWK_DATA7_CTRL**Data 7 Control****(10_H)****Reset Value:0000_H**

Field	Bits	Type	Description
DATA7	7:0	rw	Data Byte 7

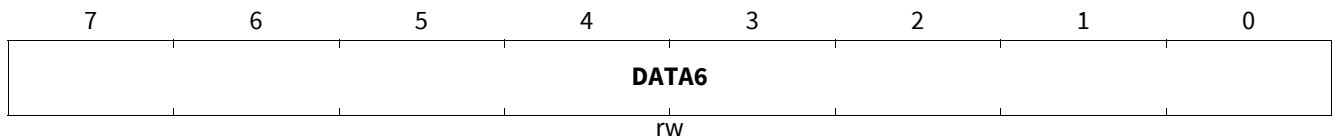
SWK_DATA6_CTRL**Data 6 Control****(11_H)****Reset Value:0000_H**

Field	Bits	Type	Description
DATA6	7:0	rw	Data Byte 6

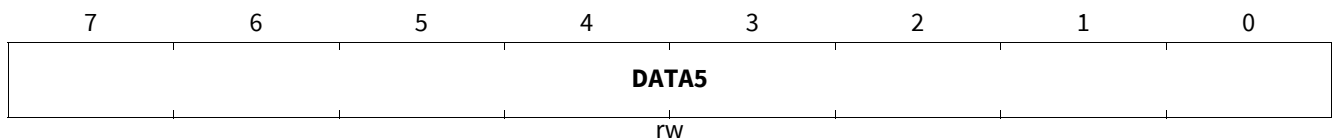
SWK_DATA5_CTRL**Data 5 Control****(12_H)****Reset Value:0000_H**

Field	Bits	Type	Description
DATA5	7:0	rw	Data Byte 5

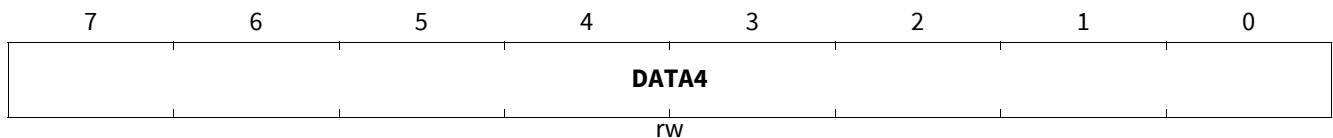
SWK_DATA4_CTRL**Data 4 Control****(13_H)****Reset Value:0000_H**

Field	Bits	Type	Description
DATA4	7:0	rw	Data Byte 4

Serial Peripheral Interface

SWK_DATA3_CTRL

Data 3 Control (14_H) **Reset Value: 0000_H**

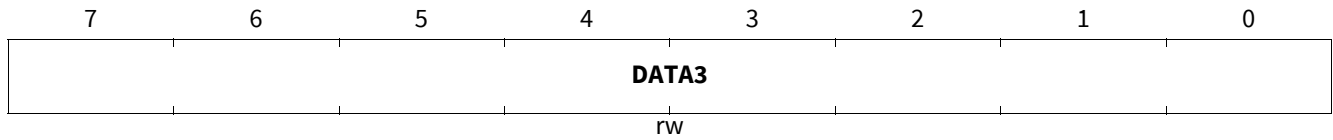

Field	Bits	Type	Description
DATA3	7:0	rw	Data Byte 3

SWK_DATA2_CTRL

Data 2 Control (15_H) **Reset Value: 0000_H**

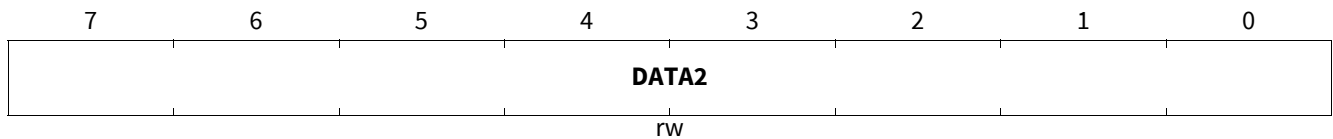

Field	Bits	Type	Description
DATA2	7:0	rw	Data Byte 2

SWK_DATA1_CTRL

Data 1 Control (16_H) **Reset Value: 0000_H**

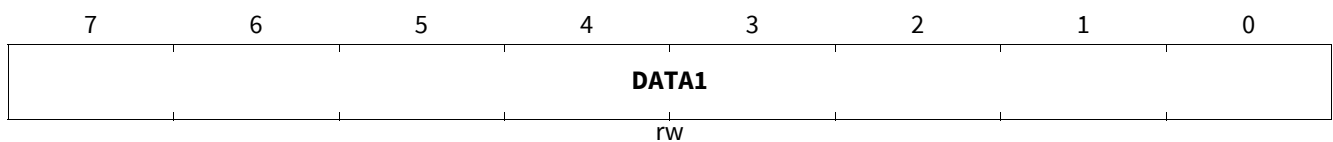

Field	Bits	Type	Description
DATA1	7:0	rw	Data Byte 1

SWK_DATA0_CTRL

Data 0 Control (17_H) **Reset Value: 0000_H**

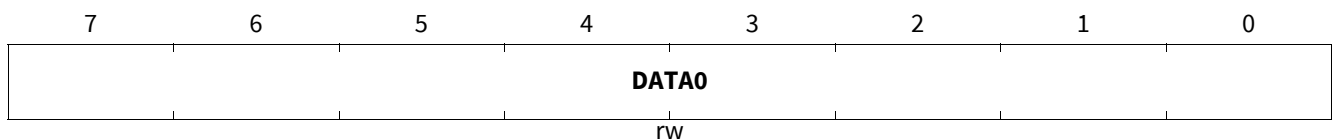

Field	Bits	Type	Description
DATA0	7:0	rw	Data Byte 0

Serial Peripheral Interface

8.7.3 Status Register

TRANS_STAT

Transceiver Status

(18_H)Reset Value: 0000_H

7	6	5	4	3	2	1	0
POR	Reserved			TXD_TO		TSD	Reserved
w1c	w1c			w1c		w1c	w1c

Field	Bits	Type	Description
POR	7	w1c	Power On Reset 0 _B , No POR occurred 1 _B , POR occurred
Reserved	6:3	w1c	Reserved
TXD_TO	2	w1c	TxD Timeout 0 _B , No TxD timeout detected 1 _B , TxD timeout detected
TSD	1	w1c	CAN Thermal Shut Down 0 _B , No Thermal Shut Down detected 1 _B , Thermal Shut Down detected
Reserved	0	w1c	Reserved

TRANS_UV_STAT

Transceiver Undervoltage Status

(19_H)Reset Value: 0000_H

7	6	5	4	3	2	1	0
VBAT_UV	Reserved	VCC_LTUV	VCC_STUV	Reserved		VIO_LTUV	VIO_STUV
w1c	w1c	w1c	w1c	w1c		w1c	w1c

Field	Bits	Type	Description
VBAT_UV	7	w1c	Battery Undervoltage detected 0 _B , No battery undervoltage detected 1 _B , Battery undervoltage detected
Reserved	6	w1c	Reserved
VCC_LTUV	5	w1c	V_{CC} long-term undervoltage detection 0 _B , No V _{CC} long-term undervoltage detected 1 _B , V _{CC} long-term undervoltage detected
VCC_STUV	4	w1c	V_{CC} short-term undervoltage detection 0 _B , No V _{CC} short-term undervoltage detected 1 _B , V _{CC} short-term undervoltage detected
Reserved	3:2	w1c	Reserved

Serial Peripheral Interface

Field	Bits	Type	Description
VIO_LTUV	1	w1c	V_{IO} long-term undervoltage detection 0 _B , No V _{IO} long-term undervoltage detected 1 _B , V _{IO} long-term undervoltage detected
VIO_STUV	0	w1c	V_{IO} short-term undervoltage detection 0 _B , No V _{IO} short-term undervoltage detected 1 _B , V _{IO} short-term undervoltage detected

ERR_STAT

Error Status

(1A_H)Reset Value:0000_H

7	6	5	4	3	2	1	0
Reserved						COM_ERR	CMD_ERR
w1c						w1c	w1c

Field	Bits	Type	Description
Reserved	7:2	w1c	Reserved
COM_ERR	1	w1c	SPI failure detected (Chapter 8.4) 0 _B , No SPI failure detected 1 _B , SPI failure detected
CMD_ERR	0	w1c	Invalid SPI Command (Chapter 8.5) 0 _B , No invalid SPI command received 1 _B , Invalid SPI command received

WAKE_STAT

Wake Status

(1B_H)Reset Value:0000_H

7	6	5	4	3	2	1	0
Reserved				LWU_DIR	LWU	WUP	WUF
w1c				r	w1c	w1c	w1c

Field	Bits	Type	Description
Reserved	7:4	w1c	Reserved
LWU_DIR	3	r	Local Wake-Up Direction 0 _B , Local Wake-Up has been performed by the falling edge 1 _B , Local Wake-Up has been performed by the rising edge
LWU	2	w1c	Local Wake-Up 0 _B , No Local Wake-Up performed 1 _B , Local Wake-Up performed
WUP	1	w1c	Wake-Up Pattern 0 _B , No Wake-Up Pattern detected 1 _B , Wake-Up Pattern detected

Serial Peripheral Interface

Field	Bits	Type	Description
WUF	0	w1c	Wake-Up Frame 0 _B , No Wake-Up Frame detected 1 _B , Wake-Up Frame detected

Serial Peripheral Interface

SWK_STAT

Selective Wake Status

(1C_H)Reset Value:0002_H

7	6	5	4	3	2	1	0
Reserved			SysErr	SYNC	CANTO	CANSIL	SWK_ACTIVE
w1c			r	r	w1c	r	r

Field	Bits	Type	Description
Reserved	7:5	w1c	Reserved
SysErr	4	r	System Error 0 _B , No System Error detected 1 _B , System Error detected
SYNC	3	r	Synchronisation of the Selective Wake Unit 0 _B , SWK Unit is not synchronous to the CAN bit stream 1 _B , SWK Unit is synchronous to the CAN bit stream
CANTO	2	w1c	CAN Timeout 0 _B , Transceiver has not entered the Selective Sleep Sub-Mode 1 _B , Transceiver has entered the Selective Sleep Sub-Mode at least once in Sleep Mode
CANSIL	1	r	CAN Silence 0 _B , Transceiver is not in the Selective Sleep Mode 1 _B , Transceiver is in the Selective Sleep Mode (No CAN bus communication)
SWK_ACTIVE	0	r	Selective Wake 0 _B , Transceiver is not in the Selective Wake Mode 1 _B , Transceiver is in the Selective Wake Mode

SWK_ECNT_STAT

Error Counter Status

(1D_H)Reset Value:0000_H

7	6	5	4	3	2	1	0
Reserved			ECNT				
r			r				

Field	Bits	Type	Description
Reserved	7:6	r	Reserved
ECNT	5:0	r	Error Counter Value

General Product Characteristics

9 General Product Characteristics

9.1 Absolute Maximum Ratings

Table 5 Absolute Maximum Ratings¹⁾

All voltages with respect to ground, positive current flowing into pin (unless otherwise specified)

Parameter	Symbol	Values			Unit	Note or Test Condition	Number
		Min.	Typ.	Max.			
Voltages							
Battery supply voltage	V_{BAT}	-0.3	–	40	V	–	P_9.1.1
Transmitter supply voltage	V_{CC}	-0.3	–	6.0	V	–	P_9.1.2
Digital voltage reference	V_{IO}	-0.3	–	6.0	V	–	P_9.1.3
CANH DC voltage versus GND	V_{CANH}	-40	–	40	V	–	P_9.1.4
CANL DC voltage versus GND	V_{CANL}	-40	–	40	V	–	P_9.1.5
Differential voltage between CANH and CANL	V_{CAN_DIFF}	-40	–	40	V	–	P_9.1.6
Voltage at pin WAKE	V_{WAKE}	-27	–	40	V	–	P_9.1.7
Voltage at pin INH	V_{INH}	-0.3	–	$V_{BAT} + 0.3$	V	–	P_9.1.8
Voltage at pin digital input pins: CSN, SCLK, MOSI, TxD	V_{Max_In}	-0.3	–	$V_{IO} + 0.3$	V	–	P_9.1.9
Voltage at pin digital output pins: MISO, RxD	V_{Max_Out}	-0.3	–	$V_{IO} + 0.3$	V	–	P_9.1.10
Currents							
Maximum output current on INH	I_{INH_Max}	-1.0	–	–	mA	–	P_9.1.11
Maximum output current on digital output pins: MISO, RxD	I_{Out_Max}	-20	–	20	mA	–	P_9.1.12
Temperatures							
Junction Temperature	T_j	-40	–	150	°C	–	P_9.1.13
Storage Temperature	T_{stg}	-55	–	150	°C	–	P_9.1.14

General Product Characteristics

Table 5 Absolute Maximum Ratings¹⁾ (cont'd)

All voltages with respect to ground, positive current flowing into pin (unless otherwise specified)

Parameter	Symbol	Values			Unit	Note or Test Condition	Number
		Min.	Typ.	Max.			
ESD Resistivity							
ESD immunity at CANH, CANL, WAKE and V_{BAT} versus to GND	$V_{ESD_HBM_CAN}$	-10	–	10	kV	HBM ²⁾	P_9.1.15
ESD immunity at all other pins	V_{ESD_HBM}	-4	–	4	kV	HBM ²⁾	P_9.1.16
ESD immunity at corner pins	$V_{ESD_CDM_CP}$	-750	–	750	V	CDM ³⁾	P_9.1.17
ESD immunity at any pin	$V_{ESD_CDM_OP}$	-500	–	500	V	CDM ³⁾	P_9.1.18

1) Not subject to production test, specified by design.

2) ESD susceptibility, Human Body Model “HBM” according to ANSI/ESDA/JEDEC JS001 (1.5k Ω , 100 pF.)

3) ESD susceptibility, Charged Device Model “CDM” according to EIA/JESD22-C101 or ESDA STM 5.3.1.

Notes

1. Stresses above the ones listed here may cause permanent damage to the device. Exposure to absolute maximum rating conditions for extended periods may affect device reliability.
2. Integrated protection functions are designed to prevent IC destruction under fault conditions described in the data sheet. Fault conditions are considered as “outside” normal operating range. Protection functions are not designed for continuous repetitive operation.

General Product Characteristics
9.2 Functional Range
Table 6 Functional range

Parameter	Symbol	Values			Unit	Note or Test Condition	Number
		Min.	Typ.	Max.			
Supply Voltages							
Transceiver battery supply voltage	V_{BAT}	5.5	–	40	V	–	P_9.2.1
Transmitter supply voltage	V_{CC}	4.75	–	5.25	V	–	P_9.2.2
Digital voltage reference	V_{IO}	3.0	–	5.5	V	–	P_9.2.3
Thermal Parameters							
Junction Temperature	T_j	-40	–	150	°C	–	P_9.2.4

Note: Within the functional or operating range, the IC operates as described in the circuit description. The electrical characteristics are specified within the conditions given in the Electrical Characteristics table.

General Product Characteristics

9.3 Thermal Resistance

Note: This thermal data was generated in accordance with JEDEC JESD51 standards. For more information please visit www.jedec.org.

Table 7 Thermal resistance¹⁾

Parameter	Symbol	Values			Unit	Note or Test Condition	Number
		Min.	Typ.	Max.			
Thermal Resistance							
Junction to ambient	R_{thJA_DSO14}	–	130	–	K/W	²⁾	P_9.3.1
Thermal Shutdown Junction Temperature							
Thermal shut-down temperature	T_{JSD}	170	180	190	°C	–	P_9.3.3
Thermal shutdown hysteresis	ΔT	5	10	20	K	–	P_9.3.4

1) Not subject to production test, specified by design

2) Specified R_{thJA} value is according to Jedec JESD51-2,-7 at natural convection on FR4 2s2p board; The Product (Chip + Package) was simulated on a 76.2 × 114.3 × 1.5 mm board with 2 inner copper layers (2 × 70 mm Cu, 2 × 35 mm Cu).

Electrical Characteristics

10 Electrical Characteristics

10.1 General Timing Parameter

Table 8 General Timing Parameter

Parameter	Symbol	Values			Unit	Note or Test Condition	Number
		Min.	Typ.	Max.			
Power up delay time	t_{PON}	–	–	1	ms	–	P_10.1.1
Delay time for mode change	t_{Mode_Change}	–	–	20	μ s	–	P_10.1.2
CAN Bus Silence timeout	$t_{Silence}$	0.6	–	1.2	s	–	P_10.1.3

10.2 Power Supply Interface

10.2.1 Current Consumption

Table 9 Current Consumption

$4.75\text{ V} < V_{CC} < 5.25\text{ V}$; $3.0\text{ V} < V_{IO} < 5.5\text{ V}$; $5.5\text{ V} < V_{BAT} < 40\text{ V}$; $R_L = 60\ \Omega$; $-40\text{ }^\circ\text{C} < T_J < 150\text{ }^\circ\text{C}$;
all voltages with respect to ground, positive current flowing into pin (unless otherwise specified)

Parameter	Symbol	Values			Unit	Note or Test Condition	Number
		Min.	Typ.	Max.			
Normal-operating Mode							
V_{BAT} supply current	I_{BAT_NM}	–	0.8	1.3	mA	INH = not connected;	P_10.2.1
V_{CC} supply current dominant bus signal	$I_{CC_NM_D}$	–	35	45	mA	–	P_10.2.2
V_{CC} supply current recessive bus signal	$I_{CC_NM_R}$	–	0.9	4.0	mA	–	P_10.2.3
V_{IO} supply current	I_{IO_NM}	–	0.2	0.5	mA	–	P_10.2.4
Receive-only Mode							
V_{BAT} and V_{CC} supply current $I_{BAT_CC_ROM} = I_{BAT} + I_{CC}$	$I_{BAT_CC_ROM}$	–	0.9	1.3	mA	INH = not connected;	P_10.2.5
V_{CC} supply current	I_{CC_ROM}	–	0.8	1.3	mA	V_{BAT} = not connected;	P_10.2.6
V_{IO} supply current	I_{IO_ROM}	–	2	20	μ A	–	P_10.2.7

Electrical Characteristics

Table 9 Current Consumption (cont'd)

$4.75\text{ V} < V_{CC} < 5.25\text{ V}$; $3.0\text{ V} < V_{IO} < 5.5\text{ V}$; $5.5\text{ V} < V_{BAT} < 40\text{ V}$; $R_L = 60\ \Omega$; $-40\text{ }^\circ\text{C} < T_J < 150\text{ }^\circ\text{C}$;
all voltages with respect to ground, positive current flowing into pin (unless otherwise specified)

Parameter	Symbol	Values			Unit	Note or Test Condition	Number
		Min.	Typ.	Max.			
Stand-by Mode							
V_{BAT} and V_{CC} supply current $I_{BAT_CC_STB} = I_{BAT} + I_{CC}$	$I_{BAT_CC_STB}$	–	260	320	μA	$T_J = 85^\circ$, INH = not connected, WAKE pin = GND, SPI Bit SWK_EN = "0", No CAN Bus communication;	P_10.2.8
V_{BAT} and V_{CC} supply current $I_{BAT_CC_STB} = I_{BAT} + I_{CC}$	$I_{BAT_CC_STB}$	–	300	365	μA	INH = not connected, WAKE pin = GND, SPI Bit SWK_EN = "0", No CAN Bus communication;	P_10.2.21
V_{CC} supply current	I_{CC_STB}	–	260	320	μA	$T_J = 85^\circ$, V_{BAT} = not connected, WAKE pin = GND, SPI Bit SWK_EN = "0", No CAN Bus communication;	P_10.2.9
V_{CC} supply current	I_{CC_STB}	–	300	365	μA	V_{BAT} = not connected, WAKE pin = GND, SPI Bit SWK_EN = "0", No CAN Bus communication;	P_10.2.38
V_{IO} supply current	I_{IO_STB}	–	2.0	5.0	μA	–	P_10.2.10
Sleep WUP Sub-Mode							
Selective-sleep Sub-Mode							
V_{BAT} supply current	I_{BAT_SLP}	–	18.0	30.0	μA	$V_{CC} = V_{IO} = 0\text{ V}$, bus biasing = GND, INH = not connected, $5.5\text{ V} < V_{BAT} < 18\text{ V}$, $-40^\circ\text{C} < T_J < 150^\circ\text{C}$;	P_10.2.11

Electrical Characteristics

Table 9 Current Consumption (cont'd)

$4.75\text{ V} < V_{CC} < 5.25\text{ V}$; $3.0\text{ V} < V_{IO} < 5.5\text{ V}$; $5.5\text{ V} < V_{BAT} < 40\text{ V}$; $R_L = 60\ \Omega$; $-40\text{ }^\circ\text{C} < T_J < 150\text{ }^\circ\text{C}$;
all voltages with respect to ground, positive current flowing into pin (unless otherwise specified)

Parameter	Symbol	Values			Unit	Note or Test Condition	Number
		Min.	Typ.	Max.			
V_{BAT} supply current	I_{BAT_SLP}	–	12.0	20.0	μA	$V_{CC} = V_{IO} = 0\text{ V}$, bus biasing = GND, INH = not connected, $5.5\text{ V} < V_{BAT} < 18\text{ V}$, $-40\text{ }^\circ\text{C} < T_J < 125\text{ }^\circ\text{C}$;	P_10.2.35
V_{CC} supply current	I_{CC_SLP}	–	0.3	5.0	μA	CSN, TxD = V_{IO} , MOSI, SCLK = GND, $V_{BAT} = 12\text{ V}$;	P_10.2.12
V_{IO} supply current	I_{IO_SLP}	–	2.0	5.0	μA	CSN, TxD = V_{IO} , MOSI, SCLK = GND;	P_10.2.13

Electrical Characteristics

Table 9 Current Consumption (cont'd)

$4.75\text{ V} < V_{CC} < 5.25\text{ V}$; $3.0\text{ V} < V_{IO} < 5.5\text{ V}$; $5.5\text{ V} < V_{BAT} < 40\text{ V}$; $R_L = 60\ \Omega$; $-40\text{ }^\circ\text{C} < T_J < 150\text{ }^\circ\text{C}$;
all voltages with respect to ground, positive current flowing into pin (unless otherwise specified)

Parameter	Symbol	Values			Unit	Note or Test Condition	Number
		Min.	Typ.	Max.			
Selective-wake mode							
V_{BAT} supply current	$I_{BAT_SEL_WK}$	–	590	705	μA	$V_{CC} = V_{IO} = 0\text{ V}$, INH = not connected, 500 kbit/s with 100% bus load, Classical CAN Frame: Id = 0x4C7 DLC = 3 Data = 0xC7, 0x8E, 0x68;	P_10.2.14
V_{BAT} supply current	$I_{BAT_SEL_WK}$	–	550	650	μA	$V_{CC} = V_{IO} = 0\text{ V}$, $T_J = 85^\circ\text{C}$, INH = not connected, 500 kbit/s with 100% bus load, Classical CAN Frame: Id = 0x4C7 DLC = 3 Data = 0xC7, 0x8E, 0x68;	P_10.2.39
V_{CC} supply current	$I_{CC_SEL_WK}$	–	0.4	5.0	μA	CSN, TxD = V_{IO} , MOSI, SCLK = GND, $V_{BAT} = 12\text{ V}$;	P_10.2.16
V_{IO} supply current	$I_{IO_SEL_WK}$	–	2.0	5.0	μA	CSN, TxD = V_{IO} , MOSI, SCLK = GND;	P_10.2.17

Electrical Characteristics

10.2.2 Undervoltage Detection

Table 10 Undervoltage Detection

$4.75\text{ V} < V_{CC} < 5.25\text{ V}$; $3.0\text{ V} < V_{IO} < 5.5\text{ V}$; $5.5\text{ V} < V_{BAT} < 40\text{ V}$; $R_L = 60\ \Omega$; $-40\text{ }^\circ\text{C} < T_J < 150\text{ }^\circ\text{C}$;
all voltages with respect to ground, positive current flowing into pin (unless otherwise specified)

Parameter	Symbol	Values			Unit	Note or Test Condition	Number
		Min.	Typ.	Max.			
Undervoltage Detection V_{BAT}							
Undervoltage detection threshold	V_{BAT_UV}	4.2	5.0	5.5	V	1)	P_10.2.18
Power down threshold	V_{BAT_POD}	3	4.0	4.4	V	1), falling edge, $V_{CC} = 0\text{ V}$;	P_10.2.20
Undervoltage glitch filter	t_{VBAT_filter}	1	–	400	μs	(see Figure 24)	P_10.2.22
Undervoltage Detection V_{CC}							
Undervoltage detection threshold	V_{CC_UV}	4.5	4.65	4.75	V	–	P_10.2.23
Power down threshold	V_{CC_POD}	2.5	3	4.0	V	falling edge, $V_{BAT} = 0\text{ V}$;	P_10.2.25
Undervoltage glitch filter	t_{VCC_filter}	1	–	10	μs	(see Figure 26)	P_10.2.27
Transmitter recovery time	$t_{VCC_recovery}$			20	μs	(see Figure 26)	P_10.2.36
Response time V_{CC} for long-term undervoltage detection	$t_{VCC_UV_T}$	$0.6 \times V_{CC_UV_T}$	–	$1.4 \times V_{CC_UV_T}$		Adjustable by SPI bit VCC_UV_T (see Figure 28 and Figure 29)	P_10.2.28
Undervoltage Detection V_{IO}							
Undervoltage detection threshold	V_{IO_UV}	2.4	2.6	3.0	V	–	P_10.2.29
Undervoltage glitch filter	t_{VIO_filter}	1	–	10	μs	(see Figure 30)	P_10.2.31
Transmitter recovery time	$t_{VIO_recovery}$			20	μs	(see Figure 30)	P_10.2.37
Response time V_{IO} for long-term undervoltage detection	$t_{VIO_UV_T}$	$0.6 \times V_{IO_UV_T}$	–	$1.4 \times V_{IO_UV_T}$		Adjustable by SPI field VIO_UV_T (see Figure 32 and Figure 33)	P_10.2.32

1) The design of the TLE9255W guarantees that the V_{Bat} powerdown threshold is below the V_{Bat} undervoltage threshold

Electrical Characteristics

10.2.3 INH Output

Table 11 INH Output

$4.75\text{ V} < V_{CC} < 5.25\text{ V}$; $3.0\text{ V} < V_{IO} < 5.5\text{ V}$; $5.5\text{ V} < V_{BAT} < 40\text{ V}$; $R_L = 60\ \Omega$; $-40\text{ }^\circ\text{C} < T_J < 150\text{ }^\circ\text{C}$;
all voltages with respect to ground, positive current flowing into pin (unless otherwise specified)

Parameter	Symbol	Values			Unit	Note or Test Condition	Number
		Min.	Typ.	Max.			
Analog Output INH							
Output voltage INH enabled	V_{INH}	$V_{BAT} - 0.8$	-	-	V	$I_{INH} = -0.2\text{ mA}$, Normal-operating Mode Receive-only Mode Stand-by Mode;	P_10.2.33
Absolute leakage current	I_{INH_Leak}	-5.0	-	-	μA	$V_{INH} = 0\text{ V}$, Sleep Mode;	P_10.2.34

10.3 CAN Controller Interface

Table 12 CAN Controller Interface

$4.75\text{ V} < V_{CC} < 5.25\text{ V}$; $3.0\text{ V} < V_{IO} < 5.5\text{ V}$; $5.5\text{ V} < V_{BAT} < 40\text{ V}$; $R_L = 60\ \Omega$; $t_{Bit(min)} = 500\text{ ns}$; $t_{Bit(Flash)} = 200\text{ ns}$;
 $-40\text{ }^\circ\text{C} < T_J < 150\text{ }^\circ\text{C}$;
all voltages with respect to ground, positive current flowing into pin (unless otherwise specified)

Parameter	Symbol	Values			Unit	Note or Test Condition	Number
		Min.	Typ.	Max.			
Receiver Output RxD							
“high” level output current	I_{RxD_H}	-	-1.8	-1.0	mA	$V_{RxD} = V_{IO} - 0.4\text{ V}$, $V_{Diff} < 0.5\text{ V}$;	P_10.3.1
“low” level output current	I_{RxD_L}	1.0	1.8	-	mA	$V_{RxD} = 0.4\text{ V}$, $V_{Diff} > 0.9\text{ V}$;	P_10.3.2
RxD toggling time after wake-up event	t_{Toggle}	6	-	14	ms	see Chapter 5.8.2	P_10.3.6
Transmitter Input TxD							
“high” level input voltage threshold	V_{TxD_H}	-	$0.5 \times V_{IO}$	$0.7 \times V_{IO}$	V	recessive state;	P_10.3.7
“low” level input voltage threshold	V_{TxD_L}	$0.3 \times V_{IO}$	$0.4 \times V_{IO}$	-	V	dominant state;	P_10.3.8
“high” level input current	I_{TxD_H}	-2.0	-	2.0	μA	$V_{TxD} = V_{IO}$;	P_10.3.10
“low” level input current	I_{TxD_L}	-220	-	-20.0	μA	$V_{TxD} = 0\text{ V}$;	P_10.3.11

Electrical Characteristics

Table 12 CAN Controller Interface (cont'd)

$4.75\text{ V} < V_{CC} < 5.25\text{ V}$; $3.0\text{ V} < V_{IO} < 5.5\text{ V}$; $5.5\text{ V} < V_{BAT} < 40\text{ V}$; $R_L = 60\ \Omega$; $t_{\text{Bit}(\text{min})} = 500\text{ ns}$; $t_{\text{Bit}(\text{Flash})} = 200\text{ ns}$;
 $-40\text{ }^\circ\text{C} < T_J < 150\text{ }^\circ\text{C}$;

all voltages with respect to ground, positive current flowing into pin (unless otherwise specified)

Parameter	Symbol	Values			Unit	Note or Test Condition	Number
		Min.	Typ.	Max.			
TxD permanent dominant timeout	$t_{\text{TxD_TO}}$	1	–	4	ms	Default value is 001_{B} in TXD_TO_CTRL Adjustable by SPI register TXD_TO_CTRL	P_10.3.12
Input capacitance	C_{TxD}	–	–	10	pF	1)	P_10.3.13

1) Not subject to production test, specified by design.

Electrical Characteristics

10.4 Transmitter and Receiver

10.4.1 Transmitter

Table 13 Transmitter

4.75 V < V_{CC} < 5.25 V; 3.0 V < V_{IO} < 5.5 V; 5.5V < V_{BAT} < 40V; $R_L = 60 \Omega$; $-40 \text{ }^\circ\text{C} < T_J < 150 \text{ }^\circ\text{C}$;
all voltages with respect to ground, positive current flowing into pin (unless otherwise specified)

Parameter	Symbol	Values			Unit	Note or Test Condition	Number
		Min.	Typ.	Max.			
Bus Transmitter							
CANH, CANL recessive output voltage	$V_{CANL/H}$	2.0	2.5	3.0	V	Normal-operating Mode, Receive-only Mode, Selective Wake Sub-Mode;	P_10.4.1
CANH, CANL recessive output voltage difference	$V_{Diff_R_NM} = V_{CANH} - V_{CANL}$	-500	-	50	mV	$V_{TXD} = V_{IO}$, no load;	P_10.4.2
CANH dominant output voltage Normal-operating Mode	V_{CANH}	2.75	-	4.5	V	$V_{TXD} = 0 \text{ V}$, $50 \Omega < R_L < 65 \Omega$;	P_10.4.3
CANL dominant output voltage Normal-operating Mode	V_{CANL}	0.5	-	2.25	V	$V_{TXD} = 0 \text{ V}$, $50 \Omega < R_L < 65 \Omega$;	P_10.4.4
CANH dominant output voltage difference: $V_{Diff_D} = V_{CANH} - V_{CANL}$ Normal-operating Mode	V_{Diff_D}	1.5	2.0	3.0	V	$V_{TXD} = 0 \text{ V}$, $50 \Omega < R_L < 65 \Omega$;	P_10.4.5
CANH dominant output voltage difference extended bus load $V_{Diff_D} = V_{CANH} - V_{CANL}$ Normal-operating Mode	$V_{Diff_D_EXT_BL}$	1.4	-	3.3	V	$V_{TXD} = 0 \text{ V}$, $R_L = 45 \Omega < R_L < 70 \Omega$	P_10.4.6
CANH, CANL dominant output voltage difference high extended bus load Normal-operating mode $V_{Diff} = V_{CANH} - V_{CANL}$	$V_{Diff_D_HEXT_BL}$	1.5	-	5.0	V	$V_{TXD} = 0 \text{ V}$, $R_L = 2240 \Omega^1$;	P_10.4.7

Electrical Characteristics

Table 13 Transmitter (cont'd)

4.75 V < V_{CC} < 5.25 V; 3.0 V < V_{IO} < 5.5 V; 5.5V < V_{BAT} < 40V; $R_L = 60 \Omega$; $-40 \text{ }^\circ\text{C} < T_J < 150 \text{ }^\circ\text{C}$;
all voltages with respect to ground, positive current flowing into pin (unless otherwise specified)

Parameter	Symbol	Values			Unit	Note or Test Condition	Number
		Min.	Typ.	Max.			
CANH, CANL recessive output voltage Sleep WUP Sub-Mode, Selective sleep Sub-Mode	V_{CANL_H}	-0.1	–	0.1	V	no load;	P_10.4.10
CANH, CANL recessive output voltage difference Sleep WUP Sub-Mode, Selective sleep Sub-Mode	V_{Diff_SLP}	-0.2	–	0.2	V	no load;	P_10.4.11
Driver symmetry $V_{SYM} = V_{CANH} + V_{CANL}$	V_{SYM}	0.9 x V_{CC}	1.0 x V_{CC}	1.1 x V_{CC}	V	Split termination, $R_L = 60 \text{ Ohm}$, $C = 4.7 \text{ nF}$, 1)2)	P_10.4.12
CANH short circuit current	I_{CANHSC}	115	-	-115	mA	$-3 \leq V_{CAN} \leq 18 \text{ V}$, $t < \mathbf{TXD_TO}$, $V_{TXD} = 0 \text{ V}$;	P_10.4.13
CANL short circuit current	I_{CANLSC}	-115	-	115	mA	$-3 \leq V_{CAN} \leq 18 \text{ V}$, $t < \mathbf{TXD_TO}$, $V_{TXD} = 0 \text{ V}$;	P_10.4.14
Leakage current CANH	I_{CANH_Ik}	-5	–	5	μA	$V_{CC} = V_{IO} = V_{BAT} = 0 \text{ V}^3)$, $0 \text{ V} < V_{CANH} < 5 \text{ V}$; $V_{CANH} = V_{CANL}$;	P_10.4.16
Leakage current CANL	I_{CANL_Ik}	-5	–	5	μA	$V_{CC} = V_{IO} = V_{BAT} = 0 \text{ V}^3)$, $0 \text{ V} < V_{CANL} < 5 \text{ V}$; $V_{CANH} = V_{CANL}$;	P_10.4.17

1) Not subject to production test, specified by design

2) V_{SYM} shall be observed during dominant and recessive state and also during the transition from dominant to recessive and vice versa, while TxD is stimulated by a square wave signal with a frequency of 62,5 kHz (125 kbit/s), 125 kHz (250 kbit/s), 250 kHz (500 kbit/s), 500 kHz (1 Mbit/s), 1 MHz (2 Mbit/s), 2,5 MHz (5 Mbit/s)

3) Additional requirement $V_{IO} = V_{CC}$ connected via 47 k Ω to GND

Electrical Characteristics

10.4.2 Receiver

Table 14 Receiver

$4.75\text{ V} < V_{CC} < 5.25\text{ V}$; $3.0\text{ V} < V_{IO} < 5.5\text{ V}$; $5.5\text{ V} < V_{BAT} < 40\text{ V}$; $R_L = 60\ \Omega$; $-40\text{ }^\circ\text{C} < T_J < 150\text{ }^\circ\text{C}$;
all voltages with respect to ground, positive current flowing into pin (unless otherwise specified)

Parameter	Symbol	Values			Unit	Note or Test Condition	Number
		Min.	Typ.	Max.			
Bus Receiver							
Common Mode Range	V_{CMR}	-12	-	12	V	-	P_10.4.18
Differential range dominant Normal-operating Mode Receive-only Mode Selective Wake SUB-Mode	$V_{Diff_D_Range}$	0.9	-	8.0	V	V_{CMR} Bus Biasing on, 1);	P_10.4.21
Differential range recessive Normal-operating Mode, Receive-only Mode Selective Wake SUB-Mode	$V_{Diff_R_Range}$	-3.0	-	0.5	V	V_{CMR} Bus Biasing on, 1);	P_10.4.23
Single ended internal resistance	R_{CAN_H} , R_{CAN_L}	6	37	50	k Ω	$-2\text{ V} \leq V_{CAN_H} \leq 7\text{ V}$, $-2\text{ V} \leq V_{CAN_L} \leq 7\text{ V}$, recessive state;	P_10.4.25
Input resistance deviation between CANH and CANL	ΔR_i	-3.0	-	3.0	%	$V_{CAN_L} = V_{CAN_H} = 5\text{ V}$, $V_{CC} = 5\text{ V}$, recessive state;	P_10.4.26
Differential internal resistance	R_{Diff}	12	75	100	k Ω	$-2\text{ V} \leq V_{CAN_H} \leq 7\text{ V}$, $-2\text{ V} \leq V_{CAN_L} \leq 7\text{ V}$, recessive state;	P_10.4.27
Input capacitance CANH, CANL versus GND	C_{In}	-	-	40	pF	1)	P_10.4.28
Differential input capacitance	C_{InDiff}	-	-	20	pF	1)	P_10.4.29

1) Not subject to production test, specified by design.

Electrical Characteristics

10.4.3 Dynamic Transceiver Parameter

Table 15 Propagation Delay

4.75 V < V_{CC} < 5.25 V; 3.0 V < V_{IO} < 5.5 V; 5.5V < V_{BAT} < 40V; $R_L = 60 \Omega$; $-40 \text{ }^\circ\text{C} < T_J < 150 \text{ }^\circ\text{C}$;
all voltages with respect to ground, positive current flowing into pin (unless otherwise specified)

Parameter	Symbol	Values			Unit	Note or Test Condition	Number
		Min.	Typ.	Max.			
Propagation Delay Characteristic							
Propagation delay, TxD to RxD	t_{Loop}	80	160	255	ns	$C_L = 100 \text{ pF}$, $C_{RXD} = 15 \text{ pF}$; (see Figure 48)	P_10.4.30
Propagation delay, increased load, TxD to RxD	t_{Loop_150}	80	–	330	ns	$C_L = 100 \text{ pF}$, $C_{RXD} = 15 \text{ pF}$, $R_L = 150 \Omega$; (see Figure 48)	P_10.4.31
Propagation delay, TxD to bus (“low” to dominant)	$t_{d(L),T}$	30	85	140	ns	$C_L = 100 \text{ pF}$, $C_{RXD} = 15 \text{ pF}$; (see Figure 48)	P_10.4.32
Propagation delay, TxD to bus (“high” to recessive)	$t_{d(H),T}$	30	90	140	ns	$C_L = 100 \text{ pF}$, $C_{RXD} = 15 \text{ pF}$; (see Figure 48)	P_10.4.33
Propagation delay, bus to RxD (dominant to “low”)	$t_{d(L),R}$	30	75	140	ns	$C_{RXD} = 15 \text{ pF}$; (see Figure 48)	P_10.4.34
Propagation delay, bus to RxD (recessive to “high”)	$t_{d(H),R}$	30	105	140	ns	$C_{RXD} = 15 \text{ pF}$; (see Figure 48)	P_10.4.35

Electrical Characteristics

Table 16 CAN FD

4.75 V < V_{CC} < 5.25 V; 3.0 V < V_{IO} < 5.5 V; 5.5V < V_{BAT} < 40V; R_L = 60 Ω; -40 °C < T_J < 150 °C;
all voltages with respect to ground, positive current flowing into pin (unless otherwise specified)

Parameter	Symbol	Values			Unit	Note or Test Condition	Number
		Min.	Typ.	Max.			
CAN FD Characteristics							
Received recessive bit width at 2 MBit/s	$t_{\text{Bit(RxD)}_2\text{M}}$	400	500	550	ns	C _L = 100 pF, C _{RxD} = 15 pF, t _{Bit} = 500 ns; (see Figure 49);	P_10.4.36
Received recessive bit width at 5 MBit/s	$t_{\text{Bit(RxD)}_5\text{M}}$	120	200	220	ns	C _L = 100 pF, C _{RxD} = 15 pF, t _{Bit} = 200 ns; (see Figure 49);	P_10.4.37
Transmitted recessive bit width at 2 MBit/s	$t_{\text{Bit(Bus)}_2\text{M}}$	435	500	530	ns	C _L = 100 pF, C _{RxD} = 15 pF, t _{Bit} = 500 ns; (see Figure 49);	P_10.4.38
Transmitted recessive bit width at 5 MBit/s	$t_{\text{Bit(Bus)}_5\text{M}}$	155	200	210	ns	C _L = 100 pF, C _{RxD} = 15 pF, t _{Bit} = 200 ns; (see Figure 49);	P_10.4.39
Receiver timing symmetry at 2 MBit/s $\Delta t_{\text{Rec}_2\text{M}} = t_{\text{Bit(RxD)}_2\text{M}} - t_{\text{Bit(Bus)}_2\text{M}}$	$\Delta t_{\text{Rec}_2\text{M}}$	-65	-	40	ns	C _L = 100 pF, C _{RxD} = 15 pF, t _{Bit} = 500 ns, (see Figure 49);	P_10.4.40
Receiver timing symmetry at 5 MBit/s $\Delta t_{\text{Rec}_5\text{M}} = t_{\text{Bit(RxD)}_5\text{M}} - t_{\text{Bit(Bus)}_5\text{M}}$	$\Delta t_{\text{Rec}_5\text{M}}$	-45	-	15	ns	C _L = 100 pF, C _{RxD} = 15 pF, t _{Bit} = 200 ns, (see Figure 49);	P_10.4.41

Electrical Characteristics

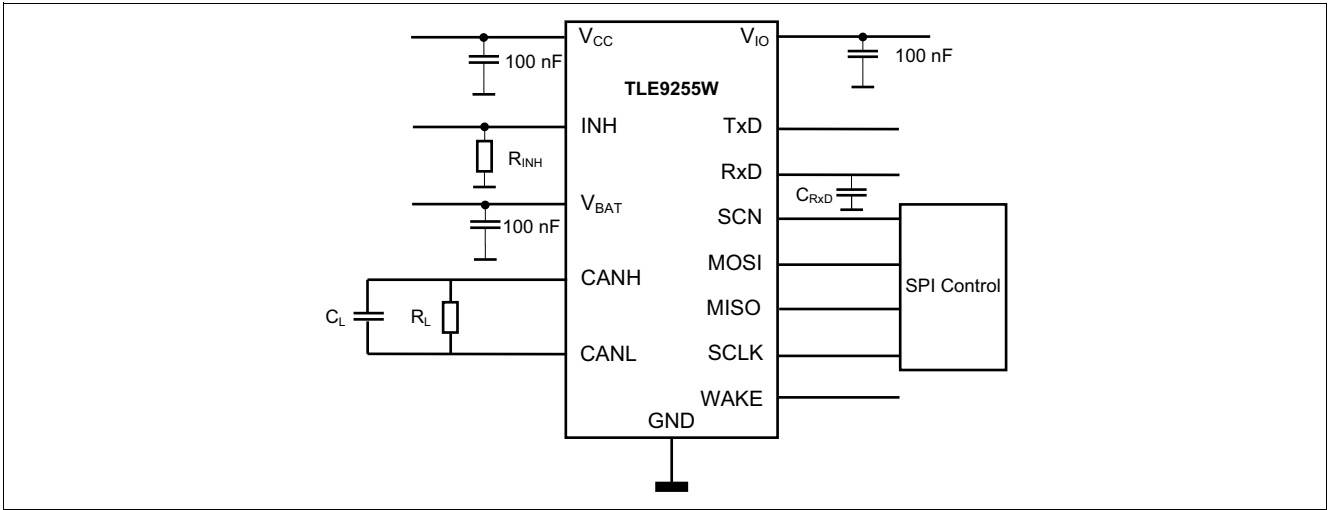

Figure 47 Test Circuit for dynamic characteristics

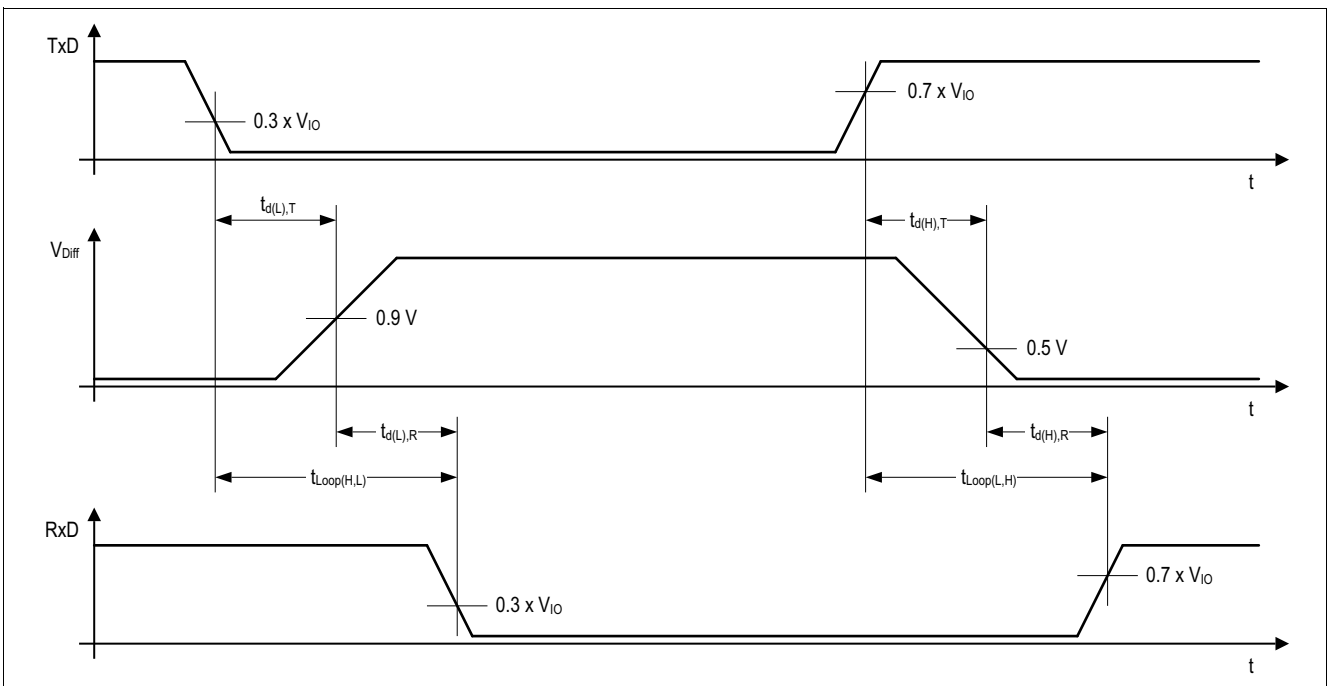

Figure 48 Timing diagrams for dynamic characteristics

Electrical Characteristics

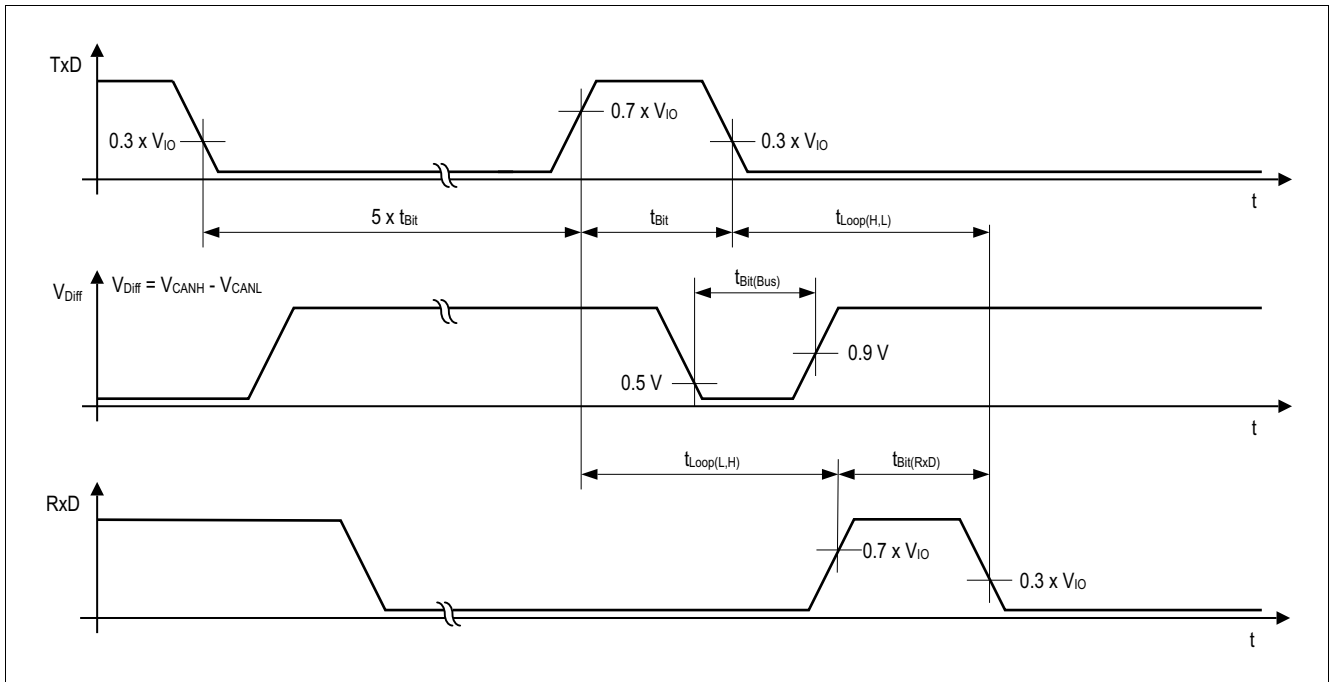

Figure 49 Recessive bit time for five dominant bits followed by one recessive bit

Electrical Characteristics

10.5 Selective Wake Parameter

10.5.1 General Timings

Table 17 Electrical Characteristics: CAN FD

4.75 V < V_{CC} < 5.25 V; 3.0 V < V_{IO} < 5.5 V; 5.5V < V_{BAT} < 40V; $R_L = 60 \Omega$; $-40^\circ\text{C} < T_J < 150^\circ\text{C}$;
all voltages with respect to ground, positive current flowing into pin (unless otherwise specified)

Parameter	Symbol	Values			Unit	Note or Test Condition	Number
		Min.	Typ.	Max.			
Network propagation delay	$t_{Net_Prop_125}$	-400	-	5450	ns	Baudrate = 125 kBit/sec;	P_10.5.1
Network propagation delay	$t_{Net_Prop_250}$	-200	-	2675	ns	Baudrate = 250 kBit/sec;	P_10.5.2
Network propagation delay	$t_{Net_Prop_500}$	-100	-	1350	ns	Baudrate = 500 kBit/sec;	P_10.5.3
Network propagation delay	$t_{Net_Prop_1000}$	-50	-	550	ns	Baudrate = 1 MBit/sec;	P_10.5.4

Electrical Characteristics

10.5.2 CAN FD Tolerance

Table 18 Electrical Characteristics: CAN FD

$4.75\text{ V} < V_{CC} < 5.25\text{ V}$; $3.0\text{ V} < V_{IO} < 5.5\text{ V}$; $5.5\text{ V} < V_{BAT} < 40\text{ V}$; $R_L = 60\ \Omega$; $-40\text{ }^\circ\text{C} < T_J < 150\text{ }^\circ\text{C}$;
all voltages with respect to ground, positive current flowing into pin (unless otherwise specified)

Parameter	Symbol	Values			Unit	Note or Test Condition	Number
		Min.	Typ.	Max.			
dominant signal which must be ignored and interpreted as a glitch	$t_{FD_Glitch_4}$	0	–	$0.05 \times t_{arbitratio_n}$		Ratio ≤ 4 , up to 2MBit/s;	P_10.5.5
dominant signal which must be detected as a data bit after the FDF bit and before EOF bit	$t_{FD_DOM_4}$	$t_{arbitratio_n} \times 0.175$	–	–		Ratio ≤ 4 , up to 2MBit/s;	P_10.5.7

Electrical Characteristics

10.6 Wake-Up

10.6.1 General Timings

Table 19 General Timings

4.75 V < V_{CC} < 5.25 V; 3.0 V < V_{IO} < 5.5 V; 5.5V < V_{BAT} < 40V; R_L = 60 Ω; -40 °C < T_J < 150 °C; all voltages with respect to ground, positive current flowing into pin (unless otherwise specified)

Parameter	Symbol	Values			Unit	Note or Test Condition	Number
		Min.	Typ.	Max.			
INH wake-up delay time	t _{WU_INH}	–	–	30.0	μs	V _{BAT} = 14.0V, R _{INH} = 100kΩ; see Figure 50	P_10.6.1
Bias reaction time	t _{RW_Bias}	–	–	100	μs	V _{CANL/H} = 0.5 V; see Figure 51	P_10.6.2

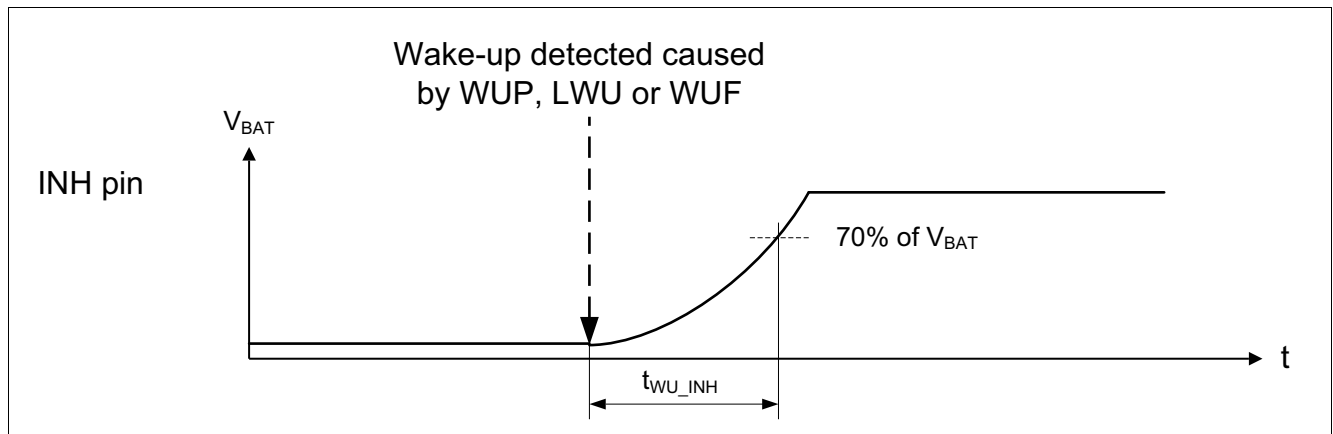

Figure 50 INH wake-up delay time

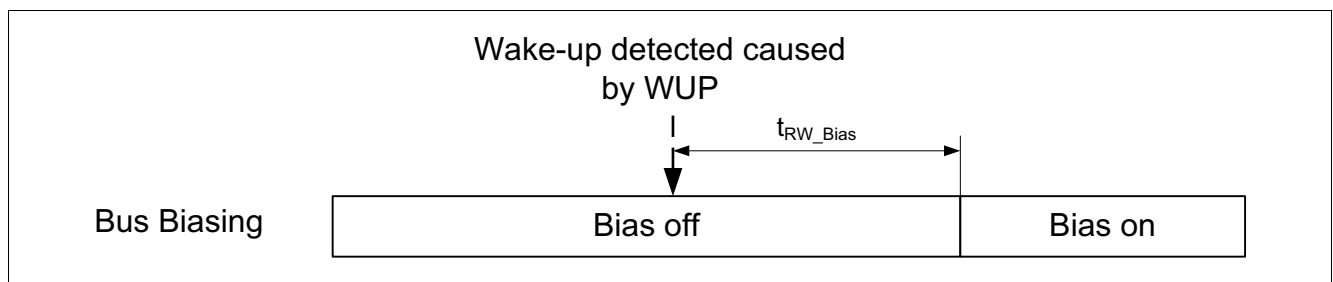

Figure 51 Bias reaction time

Electrical Characteristics

10.6.2 WUP detection Characteristics

Table 20 WUP detection

4.75 V < V_{CC} < 5.25 V; 3.0 V < V_{IO} < 5.5 V; 5.5V < V_{BAT} < 40V; $R_L = 60 \Omega$; $-40 \text{ }^\circ\text{C} < T_J < 150 \text{ }^\circ\text{C}$;
all voltages with respect to ground, positive current flowing into pin (unless otherwise specified)

Parameter	Symbol	Values			Unit	Note or Test Condition	Number
		Min.	Typ.	Max.			
Differential range dominant low power modes	$V_{\text{Diff_D_SLP_Range}}$	1.05	–	8.0	V	V_{CMR} , Bus Biasing off 1);	P_10.6.3
Differential range recessive low power modes	$V_{\text{Diff_R_SLP_Range}}$	-3.0	–	0.45	V	V_{CMR} , Bus Biasing off 1);	P_10.6.5
CAN activity filter time	t_{Filter}	0.5	–	1.8	μs	–	P_10.6.8
Bus wake-up timeout	t_{WAKE}	0.8	–	10.0	ms	–	P_10.6.9

1) Not subject to production test, specified by design.

Electrical Characteristics

10.6.3 Local Wake-Up

Table 21 Local Wake-Up

4.75 V < V_{CC} < 5.25 V; 3.0 V < V_{IO} < 5.5 V; 5.5V < V_{BAT} < 40V; $R_L = 60 \Omega$; $-40^\circ\text{C} < T_J < 150^\circ\text{C}$;
all voltages with respect to ground, positive current flowing into pin (unless otherwise specified)

Parameter	Symbol	Values			Unit	Note or Test Condition	Number
		Min.	Typ.	Max.			
Local wake-up detection threshold	V_{WAKE_TH}	0.35 x V_{BAT}	0.5 x V_{BAT}	0.65 x V_{BAT}	V	5.5 < V_{BAT} < 32V	P_10.6.10
Local wake-up detection threshold	V_{WAKE_TH}	0.25 x V_{BAT}	0.5 x V_{BAT}	0.75 x V_{BAT}	V	32 < V_{BAT} < 40V	P_10.6.15
“high” level input current	I_{WAKE_H}	-20	-	-	μA		P_10.6.12
“low” level input current	I_{WAKE_L}	-	-	20	μA		P_10.6.13
Wake pulse filter time	t_{WAKE_Filter}	10	-	50	μs	Figure 18 and Figure 19	P_10.6.14

10.7 SPI

Table 22 SPI

4.75 V < V_{CC} < 5.25 V; 3.0 V < V_{IO} < 5.5 V; 5.5V < V_{BAT} < 40V; $R_L = 60 \Omega$; $-40^\circ\text{C} < T_J < 150^\circ\text{C}$;
all voltages with respect to ground, positive current flowing into pin (unless otherwise specified)

Parameter	Symbol	Values			Unit	Note or Test Condition	Number
		Min.	Typ.	Max.			
SPI Clock Frequency							
SPI clock frequency	f_{SPI}	0.01	-	4.0	MHz	-	P_10.7.1
Logic Input MOSI, SCLK							
“high” level input voltage threshold	V_H	-	0.5 x V_{IO}	0.7 x V_{IO}	V	-	P_10.7.2
“low” level input voltage threshold	V_L	0.3 x V_{IO}	0.4 x V_{IO}	-	V	-	P_10.7.3
“high” level input current	I_H	20	-	220	μA	$V_{MOSI} = V_{IO}$, $V_{SCLK} = V_{IO}$, pull-down;	P_10.7.5
“low” level input current	I_L	-2.0	-	2.0	μA	$V_{MOSI} = 0\text{V}$, $V_{SCLK} = 0\text{V}$;	P_10.7.6
Input capacitance	C_{IN}	-	-	10	pF	1)	P_10.7.7

Electrical Characteristics

Table 22 SPI (cont'd)

4.75 V < V_{CC} < 5.25 V; 3.0 V < V_{IO} < 5.5 V; 5.5V < V_{BAT} < 40V; $R_L = 60 \Omega$; -40 °C < T_J < 150 °C;
all voltages with respect to ground, positive current flowing into pin (unless otherwise specified)

Parameter	Symbol	Values			Unit	Note or Test Condition	Number
		Min.	Typ.	Max.			
Logic Input CSN							
“high” level input voltage threshold	V_H	-	0.5 x V_{IO}	0.7 x V_{IO}	V	-	P_10.7.21
“low” level input voltage threshold	V_L	0.3 x V_{IO}	0.4 x V_{IO}	-	V	-	P_10.7.31
“high” level input current	I_H	-2.0	-	2.0	μA	$V_{CSN} = V_{IO}$, pull-down;	P_10.7.33
“low” level input current	I_L	-200	-	-20	μA	$V_{CSN} = 0$ V;	P_10.7.34
Input capacitance	C_{IN}	-	-	10	pF	1)	P_10.7.35
Logic Output: MISO							
“high” level output current	I_{MISO_H}	-	-	-1.0	mA	$V_{MISO} = V_{IO} - 0.4$ V;	P_10.7.8
“low” level output current	I_{MISO_L}	1	-	-	mA	$V_{MISO} = 0.4$ V;	P_10.7.9
Rise time	t_{MISO_R}	-	-	80.0	ns	30% - 70% of V_{IO} , $C_{MISO} = 100$ pF;	P_10.7.10
Fall time	t_{MISO_F}	-	-	80.0	ns	70% - 30% of V_{IO} , $C_{MISO} = 100$ pF;	P_10.7.11
Difference of rise and fall time	$ t_{MISO_R} - t_{MISO_F} $	-	-	10.0	ns	$C_{MISO} = 100$ pF;	P_10.7.12
“tri-state” leakage current	I_{MISO_Tri}	-10.0	-	10.0	μA	$0 < V_{MISO} < V_{IO}$;	P_10.7.13
“tri-state” Input capacitance	C_{IN_MISO}	-	-	10	pF	1)	P_10.7.14
SPI data timing¹⁾							
Clock “high” period	t_{SCLK_H}	125	-	-	ns	-	P_10.7.15
Clock “low” period	t_{SCLK_L}	125	-	-	ns	-	P_10.7.16
Clock “low” before CSN “low”	t_{bef}	125	-	-	ns	-	P_10.7.17
CSN setup time	t_{lead_NM}	1	-	-	μs	Normal-operating Mode, Stand-by Mode, Receive-only Mode;	P_10.7.18
CSN setup time	t_{lead_SP}	6.0	-	-	μs	Selective Wake Sub-Mode, Selective Sleep Sub-Mode, Sleep WUP Mode;	P_10.7.19
SCLK setup time	t_{lag}	250	-	-	ns	-	P_10.7.20
MOSI setup time	t_{MOSI_SU}	25	-	-	ns	-	P_10.7.22

Electrical Characteristics

Table 22 SPI (cont'd)

4.75 V < V_{CC} < 5.25 V; 3.0 V < V_{IO} < 5.5 V; 5.5V < V_{BAT} < 40V; R_L = 60 Ω; -40 °C < T_J < 150 °C;
 all voltages with respect to ground, positive current flowing into pin (unless otherwise specified)

Parameter	Symbol	Values			Unit	Note or Test Condition	Number
		Min.	Typ.	Max.			
MOSI hold time	t _{MOSI_HO}	50	-	-	ns	-	P_10.7.23
CSN "high" time	t _{CSN_H}	3.0	-	-	μs	-	P_10.7.24
Maximum signal rise time on SPI inputs: MOSI, SCLK and CSN	t _{R_max}	-	-	50	ns	-	P_10.7.25
Maximum signal fall time on SPI inputs: MOSI, SCLK and CSN	t _{F_max}	-	-	50	ns	-	P_10.7.26
MISO enable time	t _{MISO_EN}	-	-	120	ns	-	P_10.7.27
MISO enable time in Sleep Mode	t _{MISO_EN_SLP}	-	-	5.5	μs	-	P_10.7.36
MISO disable time	t _{MISO_DIS}	-	-	50	ns	-	P_10.7.28
MISO valid time	t _{MISO_VAL}	-	-	100	ns	-	P_10.7.29
CSN Timeout	t _{CSN_TO}	2.1	-	4	ms	-	P_10.7.30

1) Not subject to production test, specified by design.

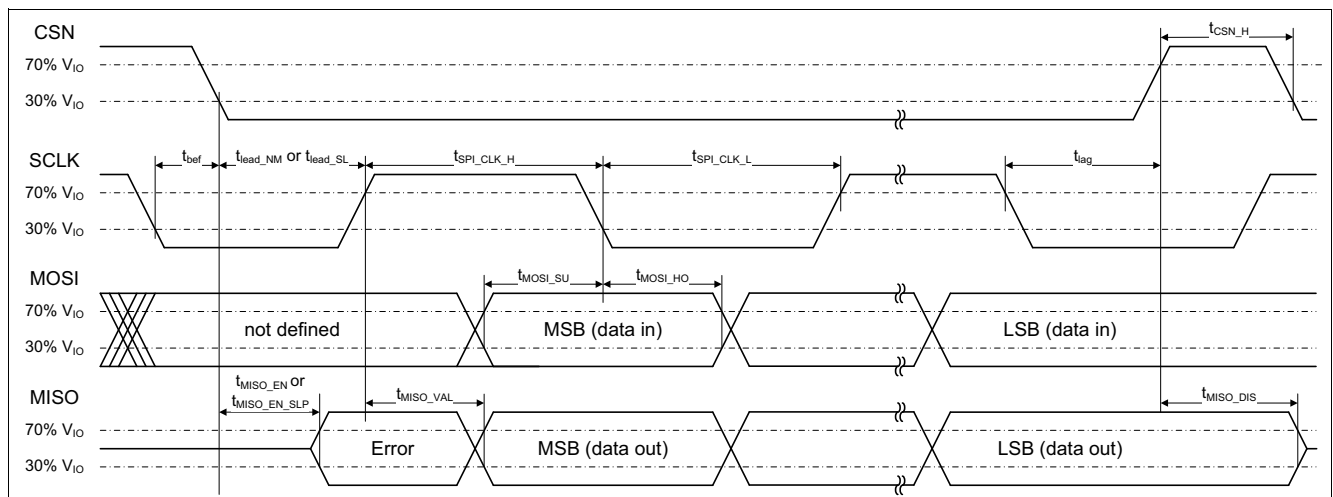

Figure 52 SPI timings

Application Information

11 Application Information

11.1 ESD Robustness according to IEC 61000-4-2

Tests for ESD robustness according to IEC61000-4-2 “Gun test” (150 pF, 330 Ω) have been performed. The results and test conditions are available in a separate test report.

Table 23 ESD robustness according to IEC61000-4-2

Performed Test	Result	Unit	Remarks
Electrostatic discharge voltage at pin V_{BAT} , CANH, CANL and WAKE ¹⁾ versus GND	$\geq +10$	kV	²⁾ Positive pulse
Electrostatic discharge voltage at pin V_{BAT} , CANH, CANL and WAKE ¹⁾ versus GND	≤ -10	kV	²⁾ Negative pulse

1) 10 nF capacitor and 3.3 kΩ resistor required (see [Figure 53](#)).

2) ESD susceptibility “ESD GUN” according to GIFT / ICT paper: “EMC Evaluation of CAN Transceivers, IEC TS 62228”, section 4.3. (DIN EN 61000-4-2)
Tested by external test facility (IBEE Zwickau, EMC test report).

Application Information

11.2 Application Example

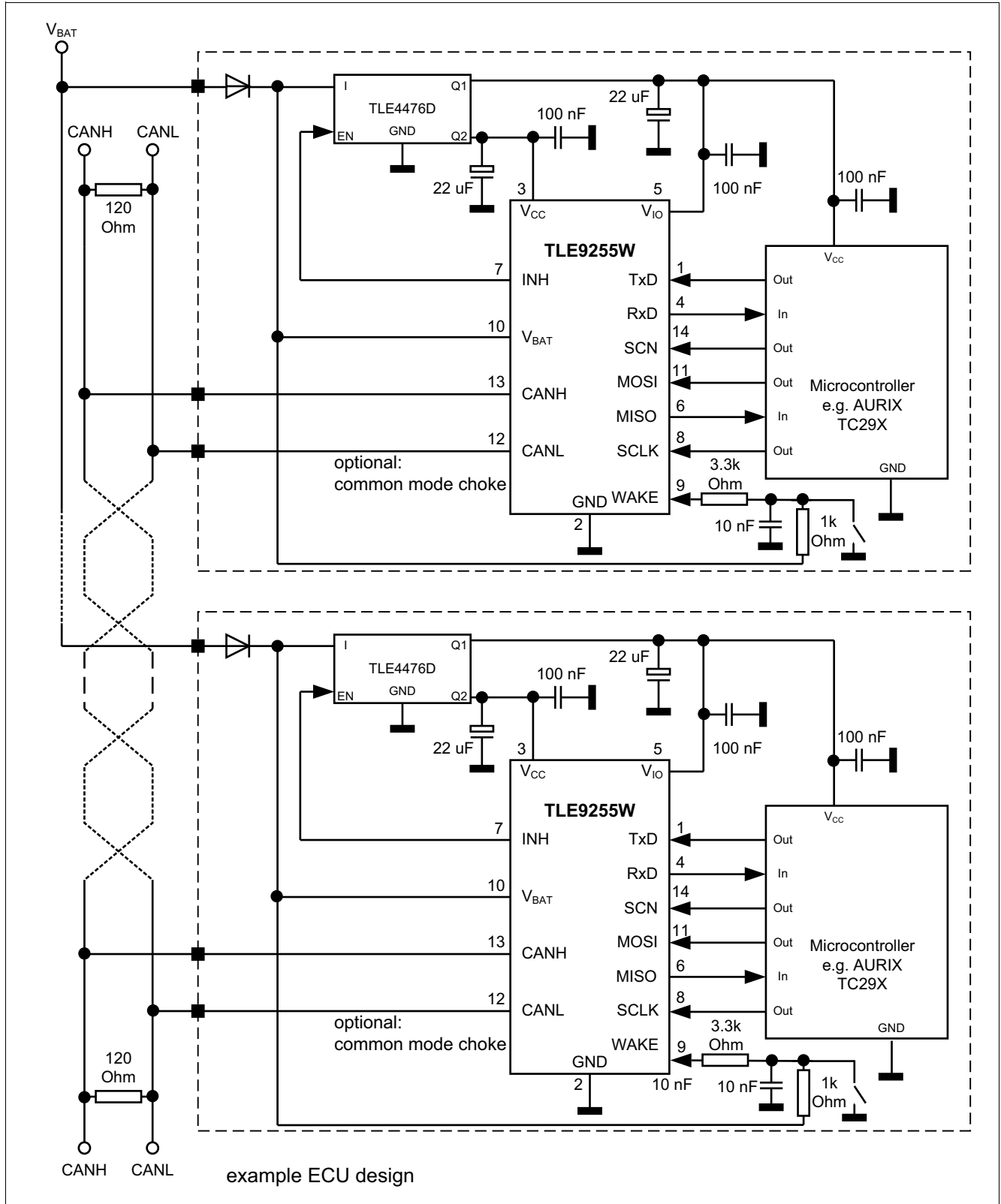

Figure 53 Application circuit

Application Information

11.3 Voltage Adaption to the Microcontroller Supply

To adapt the digital input and output levels of the TLE9255W to the I/O levels of the microcontroller, connect the power supply pin V_{IO} to the microcontroller voltage supply (see [Figure 53](#)).

Note: In case the digital supply voltage V_{IO} is not required in the application, connect the digital supply voltage V_{IO} to the transmitter supply V_{CC} .

11.4 Further Application Information

- Please contact us for information regarding the pin FMEA.
- For further information you may visit: www.infineon.com/automotive-transceiver

Package Outlines

12 Package Outlines

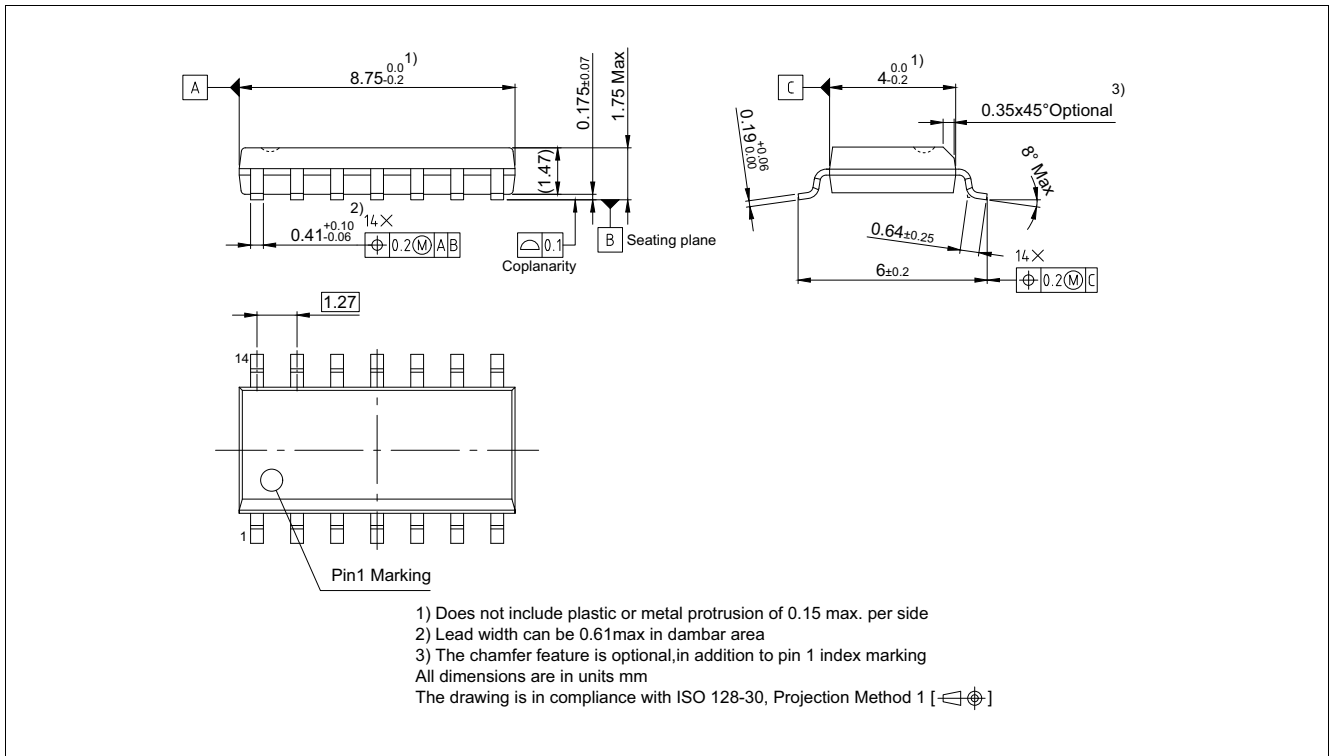

Figure 54 PG-DSO-14

Package Outlines

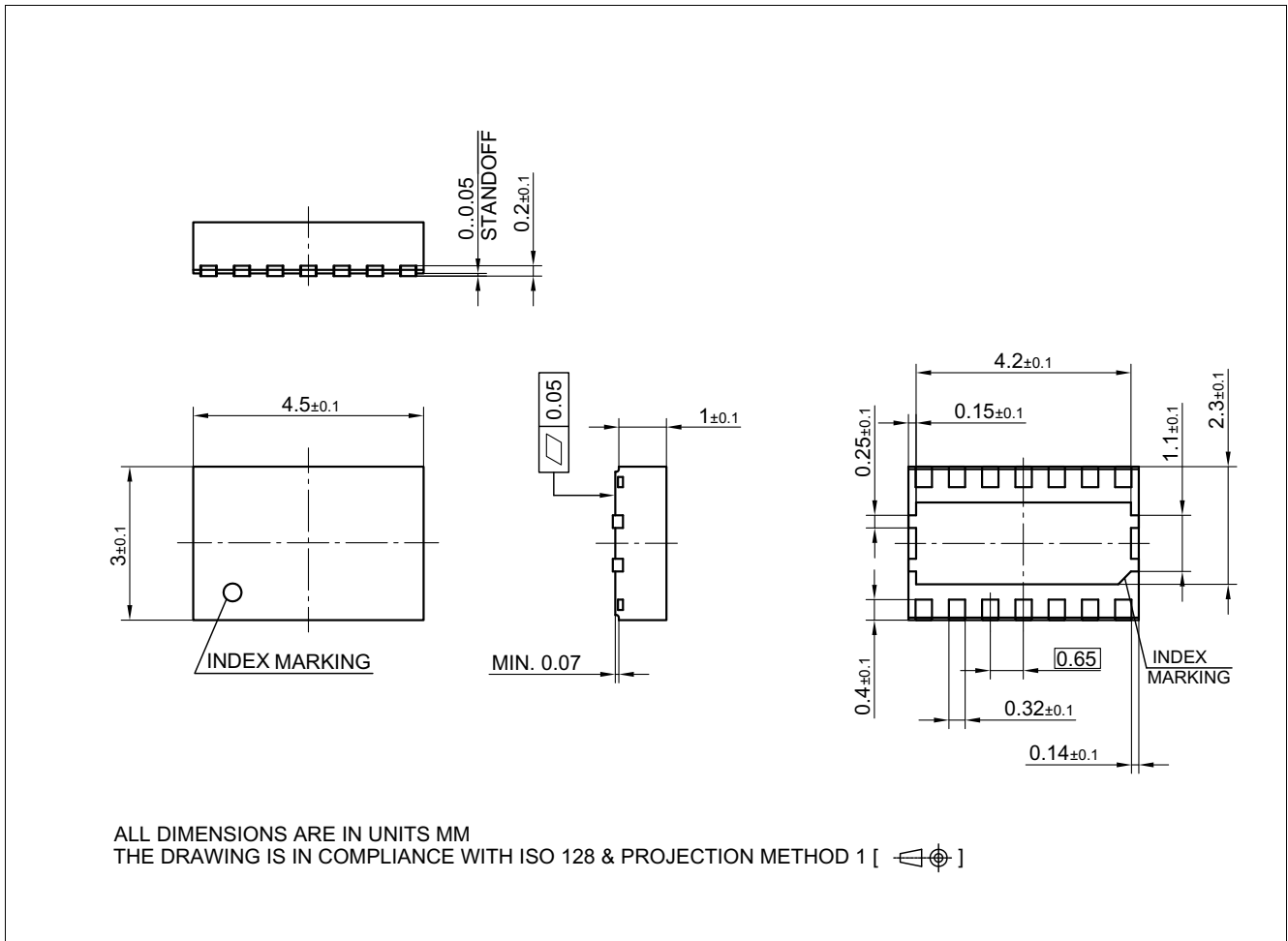

Figure 55 PG-TSON-14

Green Product (RoHS compliant)

To meet the world-wide customer requirements for environmentally friendly products and to be compliant with government regulations the device is available as a green product. Green products are RoHS-Compliant (i.e Pb-free finish on leads and suitable for Pb-free soldering according to IPC/JEDEC J-STD-020).

For further information on alternative packages, please visit our website:
<http://www.infineon.com/packages>.

Dimensions in mm

Terminology

DLC	Data Length Code
LWU	Local Wake Up
SPI	Serial Peripheral Interface
WUF	Wake-up Frame
WUP	Wake-up Pattern

Revision History

13 Revision History

Revision	Date	Changes
1.00	2016-09-15	Data Sheet Rev. 1.0 created
1.01	2017-02-27	<ul style="list-style-type: none"> • SWK_ACTIVE bit description changed in register SWK_STAT • Internal state transitions have higher priority than mode change SPI commands • $t_{FD_Glitch_10}$ and $t_{FD_DOM_10}$ removed (Chapter 10.5.2)
1.02	2018-02-02	<ul style="list-style-type: none"> • ESD immunity at CANH, CANL, WAKE and V_{BAT} versus to GND set from +-8 kV to +-10 kV • ESD immunity at all other pins set from +-2kV to +-4 kV • ESD robustness according to IEC 61000-4-2 changed form +-8 kV to +-10 kV • Tightening of limits for V_{BAT} and V_{CC} supply current at Receive-only Mode (P_10.2.5) • Tightening of limits for V_{IO} supply current at Normal-operating Mode (P_10.2.4) • Tightening of limits for V_{CC} supply current dominant bus signal at Normal-operating Mode (P_10.2.2) • Tightening of limits for V_{BAT} supply current at Normal-operating Mode (P_10.2.1) • Tightening of limits for V_{IO} supply current at Receive-only Mode (P_10.2.7) • Pin configuration for TSON Package added (Figure 2) • Test condition for the Parameter Absolute current on CAN_L (P_10.04.14) compliant to ISO 11898-2 (2016). • Test condition for the Parameter Absolute current on CAN_H (P_10.04.13) compliant to ISO 11898-2 (2016) • Test condition for the Parameter Driver Symmetry (P_10.04.12) compliant to ISO 11898-2 (2016). • Test condition for the Parameter Input resistance deviation between CANH and CANL(P_10.04.26) compliant to ISO 11898-2 (2016).
1.03	2018-10-25	<ul style="list-style-type: none"> • Package outline for TSON changed
1.04	2021-08-04	Editorial change: package outline drawing PG-DSO14 updated

Trademarks

All referenced product or service names and trademarks are the property of their respective owners.

Edition 2021-08-04

Published by

Infineon Technologies AG

81726 Munich, Germany

© 2021 Infineon Technologies AG.

All Rights Reserved.

Do you have a question about any aspect of this document?

Email: erratum@infineon.com

Document reference

Z8F53542536

IMPORTANT NOTICE

The information given in this document shall in no event be regarded as a guarantee of conditions or characteristics ("Beschaffheitsgarantie").

With respect to any examples, hints or any typical values stated herein and/or any information regarding the application of the product, Infineon Technologies hereby disclaims any and all warranties and liabilities of any kind, including without limitation warranties of non-infringement of intellectual property rights of any third party.

In addition, any information given in this document is subject to customer's compliance with its obligations stated in this document and any applicable legal requirements, norms and standards concerning customer's products and any use of the product of Infineon Technologies in customer's applications.

The data contained in this document is exclusively intended for technically trained staff. It is the responsibility of customer's technical departments to evaluate the suitability of the product for the intended application and the completeness of the product information given in this document with respect to such application.

For further information on technology, delivery terms and conditions and prices, please contact the nearest Infineon Technologies Office (www.infineon.com).

WARNINGS

Due to technical requirements products may contain dangerous substances. For information on the types in question please contact your nearest Infineon Technologies office.

Except as otherwise explicitly approved by Infineon Technologies in a written document signed by authorized representatives of Infineon Technologies, Infineon Technologies' products may not be used in any applications where a failure of the product or any consequences of the use thereof can reasonably be expected to result in personal injury.

Mouser Electronics

Authorized Distributor

Click to View Pricing, Inventory, Delivery & Lifecycle Information:

Infineon:

[TLE9255WSKXUMA2](#) [TLE9255WLCXUMA1](#)