

97100 Inline, 3/2 & 5/2 Indirect solenoid actuated spool valves



- > Port size: 1/4" (ISO G/NPT)
- > For single and double operated actuators
- > Crossover-free switching, switch-over function guaranteed even with small cross section air supply
- > Manual override with detent standard
- > The solenoid valves are applicable in the protection class
 - > - Ex m for zones 1, 2, 21, 22 (gases and dusts) ATEX cat.II 2GD
 - > - Ex ia for zones 1, 21, (gases) ATEX cat.II 2G,
 - > - Ex nA, for zones 2, 22 (gases and dusts) ATEX cat.II 3 GD



Technical features

Medium:

Filtered, non-lubricated or dry compressed air

Operation:

Indirectly solenoid operated soft seal valves

Operating pressure:

2 ... 8 bar (29 ... 116 psi)

Orifice:

6 mm

Port size:

G1/4, 1/4 NPT

Mounting position:

Optional

Flow direction:

Fixed

Electrical connection:

See solenoid table

Ambient/Media temperature:

Valve:

-15° ... +60°C (+5° ... +140°F)

Depending on solenoid system

Air supply must be dry enough to avoid ice formation at temperatures below +2°C (+35°F).

Materials:

Housing: Aluminium 3.0615

anodized

Pilot flange: Plastic (PBT)

Seals: NBR



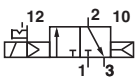
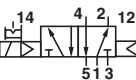
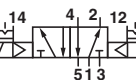
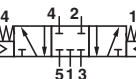

Technical data

Symbol	Port size	Function	Actuation/return	Operating pressure (bar)	Flow (l/min)	Weight (kg)	Dimension No.	Model *1)
	G 1/4	3/2	Solenoid/ air spring	2 ... 8	750	0,25	1	9713032
	1/4 NPT	3/2	Solenoid/ air spring	2 ... 8	750	0,25	1	9713042
	G 1/4	5/2	Solenoid/ air spring	2 ... 8	750	0,25	2	9710032
	1/4 NPT	5/2	Solenoid/ air spring	2 ... 8	750	0,25	2	9710042
	G 1/4	5/2	Solenoid/Solenoid	2 ... 8	750	0,35	3	9711032
	1/4 NPT	5/2	Solenoid/Solenoid	2 ... 8	750	0,35	3	9711042
	G 1/4	5/3 APB	Solenoid/Solenoid, APB	2 ... 8	500	0,40	4	9712032
	1/4 NPT	5/3 APB	Solenoid/ Solenoid, APB	2 ... 8	500	0,40	4	9712042

*1) When ordering, please indicate solenoid, voltage and current (frequency).

Valve function: APB = All Ports Blocked

Solenoids, standard voltages

	Power consumption		Rated current		Protection class IP/NEMA	Ex-Protection (ATEX-Cate- gory)	Temperature Ambient/ Media (°C)	Electrical connection	Weight (kg)	Drawing No.	Circuit diagram No.	Model
	24 V d.c. (W)	230 V a.c. (VA)	24 V d.c. (mA)	230 V a.c. (mA)								
	1,8	—	70	—	IP65 (with connector)	—	-15 ... +50	Connector DIN EN 175301-803, form B *1)	0,1	11	1	3050
	0,7	2,0 *2)	29	4	IP65 (with connector)	—	-15 ... +50	Connector DIN EN 175301-803, form A *1)	0,1	12	1	3034
	2	—	85	—	IP65 (with connector)	II 3 G Ex nA IIC T5 Gc II 3 D Ex tc IIC T95° Dc IP65	-15 ... +50	Special connector DIN EN 175301-803, form A	0,3	12	1	3046
	2,7	—	115	—	IP65 (with connector)	II 2 G Ex mb IIC T5 Gb II 2 D Ex mb tb T95°C Db	-20 ... +50 *2)	Cable length 3 m	0,3	13	14	3062
	—	2,1	—	9	IP65 (with connector)	II 2 G Ex mb IIC T5 Gb II 2 D Ex mb tb T95°C Db	-20 ... +50 *2)	Cable length 3 m	0,3	13	15	3063
	2,7	—	115	—	IP66 (with connector)	—	-10 ... +50	Connector *1) M12x1, DIN IEC 61076-2-101 Solenoid with yellow LED	0,1	14	17	3071

Standard voltages (±10%) 24 V d.c., 230 V a.c., other voltages on request. Design according to VDE 0580, EN 50014/50028. 100% duty cycle.

*1) Connector is not scope of delivery, see table »Accessories«

*2) For battery installation +40°C only

Solenoid actuators for intrinsically-safe circuits

	Nominal resistance RN coil (Ω)	Min. required switching current (mA)	Resistance Rw 60 coil (Ω)	Required voltage at terminal Rw 60 (V)	IP Protection class	Ex-Protection (ATEX-Cate- gory)	Temperature Ambient/ Media (°C)	Weight (kg)	Drawing No.	Circuit diagram No.	Model
	275	37	345	13,8	IP65 (with connector)	II 2 G Ex ia IIC T6/ T4 Ga	T6: -40 ... +50 T4: -40 ... 85	0,2	15	13	3039

When selecting an intrinsically safe power supply, the permissible maximum values according to the Certificate of Conformity should be taken in account.

On the other hand, the low effective inductivity and capacity can be ignored.

Connector DIN EN 175301-803 form A is not scope of delivery,, see table »Accessories«

Approvals





Model	Approvals ATEX	IECEX		Datasheet
		IECEX	FM	
3039	PTB 03 ATEX 2134	—	CSA-LR 51090-4	N/en 71.550
304x	PTB 06 ATEX 2055	—	—	N/en 71.555
306x	PTB 03 ATEX 2015	—	—	N/en 71.560
307x	EC-Declaration of Conformity	—	—	N/en 71.565

Option selector
971★0★2.★★★★.★★★.★0

Function	Substitute
5/2 way valve with spring return	0
5/2 way impuls	1
5/3 way valve with spring return (APB)	2
3/2 way valve with spring return	3
Port size	Substitute
G 1/4	3
1/4 NPT	4

Voltage	Substitute
24 V d.c.	024.0
230 V a.c.	230.5
Solenoid	Substitute
see table	





Accessories

Connectors DIN EN 175301-803	Connectors M12 x 1	M12 x 1	Silencer
			
0570275 Form A	0523055 (without cable)	0523056 (90°, without cable)	Page 7 M/S2 (G1/4)
0663303 Form A (with rectifier)	0523057 (2 m cable)	0523058 (90°, 2 m cable length)	C/S2 (1/4 NPT)
0680003 Form B	0523052 (5 m cable)	0523053 (90°, 5 m cable length)	

Manifold plates

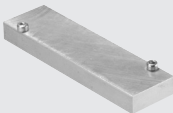
				
Page 5 2 stations	3 stations	4 stations	6 stations	12 stations
2221102	2221103	2221104	2221106	2221112

Accessories for manifold plates

Blanking plate *1)	Blanking plug for 2 station and 3 station manifolds	Pressure shut-off part *2) for 4 station up to 12 station manifolds	DIN mounting kit
			
0100563	0701209	0100569	0101796

*1) For blocking of unused valve stations

*2) Necessary for using two different pressure

Dimensions
Valves

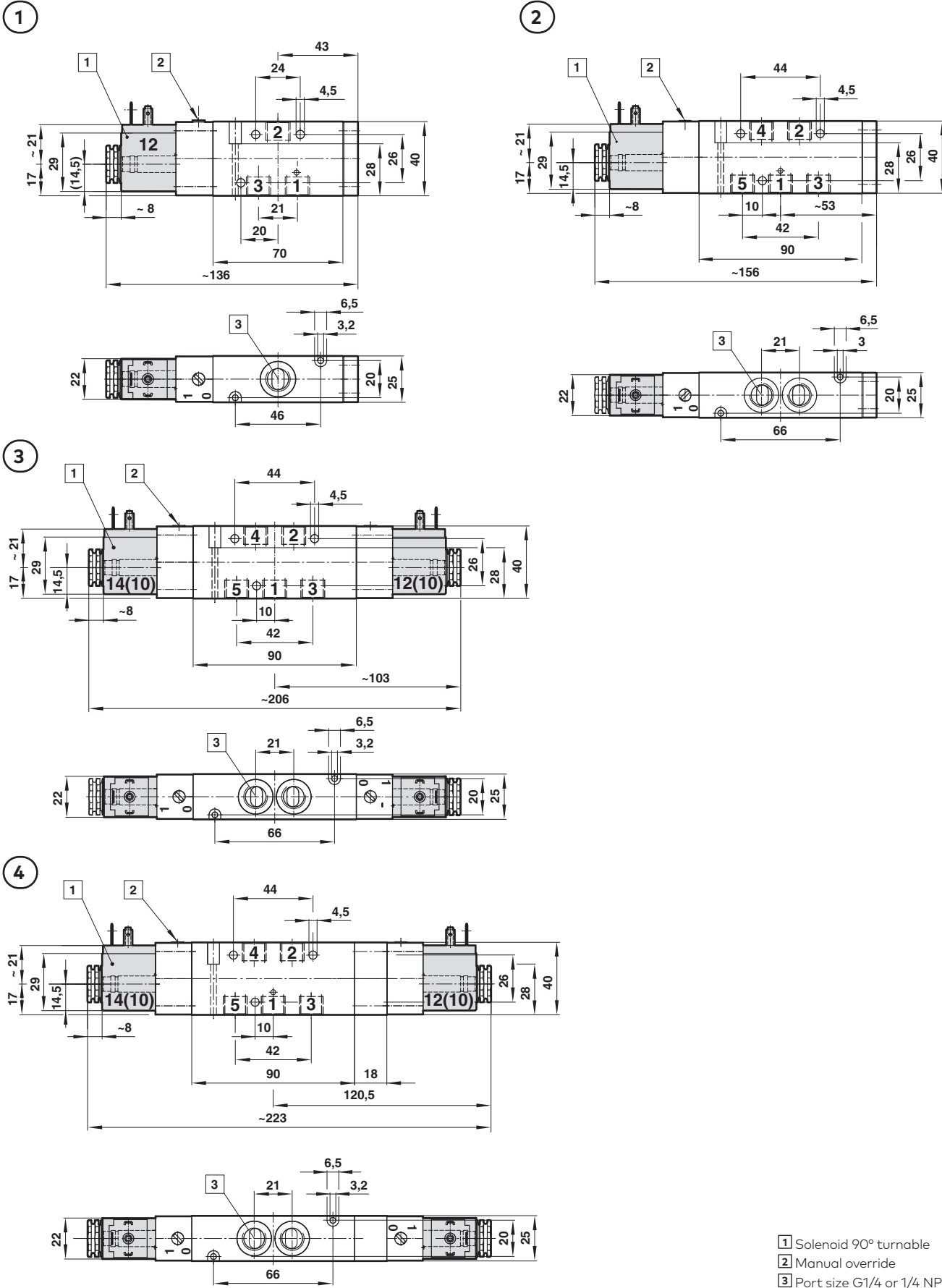
 Dimensions in mm
 Projection/First angle

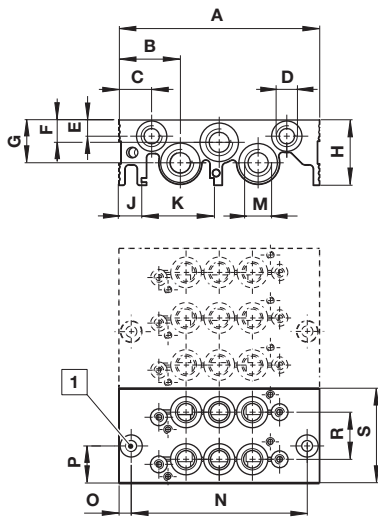
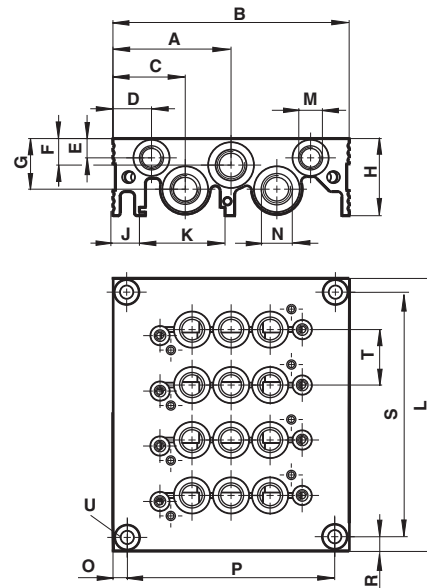
Dimensions
Manifold plate 2 and 3 stations

Manifold plate 4 ... 12 stations

 Dimensions in mm
 Projection/First angle

Model	A	B	C	D	E	F	G	H	J	K	L	M	N	O	P	R	S	T	U
2er	52	104	26	9	8	13	20	33	10	35,5	52	G 1/8	G 3/8	40	24	26	-	26	for M5
3er	52	104	26	9	8	13	20	33	10	35,5	78	G 1/8	G 3/8	40	24	52	-	26	for M5
4-12er	52	104	26	9	8	13	20	33	10	35,5	(x-26)+23	G 1/8	G 3/8	40	24	6,5	(x-26)+10	26	for M5

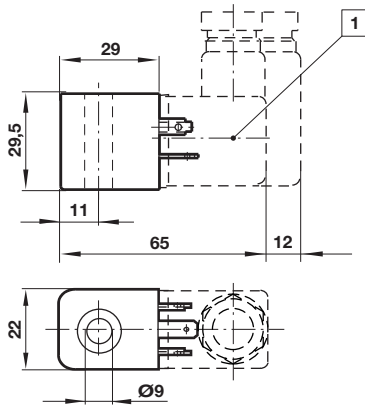
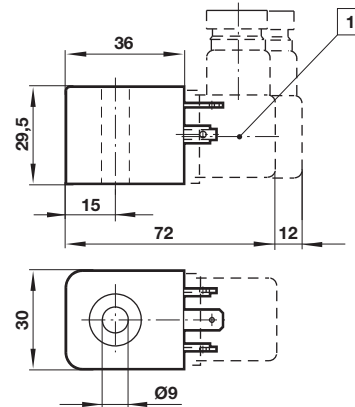
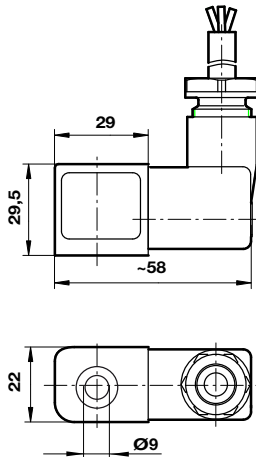
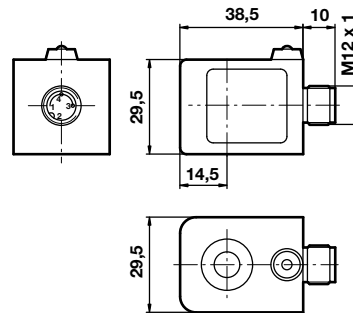
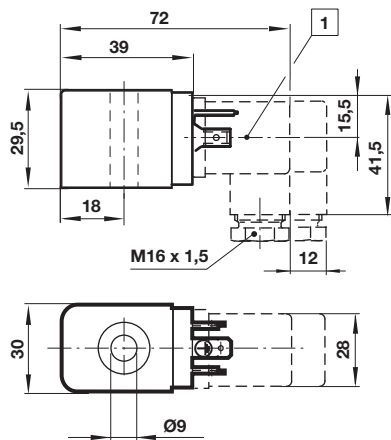
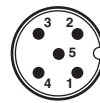
Dimensions

 Dimensions in mm
 Projection/First angle

11

12

13

14

15

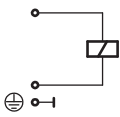
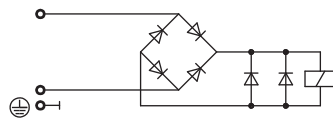
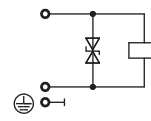
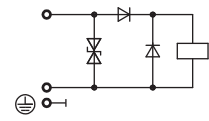
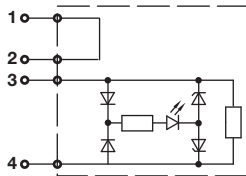
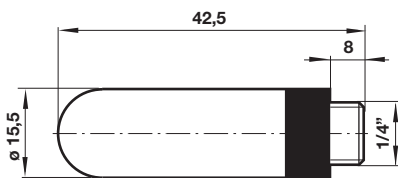
Electrical connection M 12 x 1

Pin	Signal	Cable
1	+ UB	brown
2	Out 2 (PNP) / analogue 4 to 20 mA	white
3	0 Volt	blue
4	Out 1 (PNP)	black

1 Connector 4 x 90° turnable

Circuit diagrams

 Dimensions in mm
 Projection/First angle

1

13

14

15

17

Silencer
Model: M/S2, C/S2

Warning

These products are intended for use in industrial compressed air systems only. Do not use these products where pressures and temperatures can exceed those listed under **»Technical features/ data«**.

Before using these products with fluids other than those specified, for non-industrial applications, life-support systems or other applications not within published specifications, consult Norgren.

Through misuse, age, or malfunction, components used in fluid power systems can fail in various modes.

The system designer is warned to consider the failure modes of all component parts used in fluid power systems and to provide adequate safeguards to prevent personal injury or damage to equipment in the event of such failure.

System designers must provide a warning to end users in the system instructional manual if protection against a failure mode cannot be adequately provided.

System designers and end users are cautioned to review specific warnings found in instruction sheets packed and shipped with these products.