

# NCLS-30-UP6X-H1141

## Capacitive Limit Level Sensor

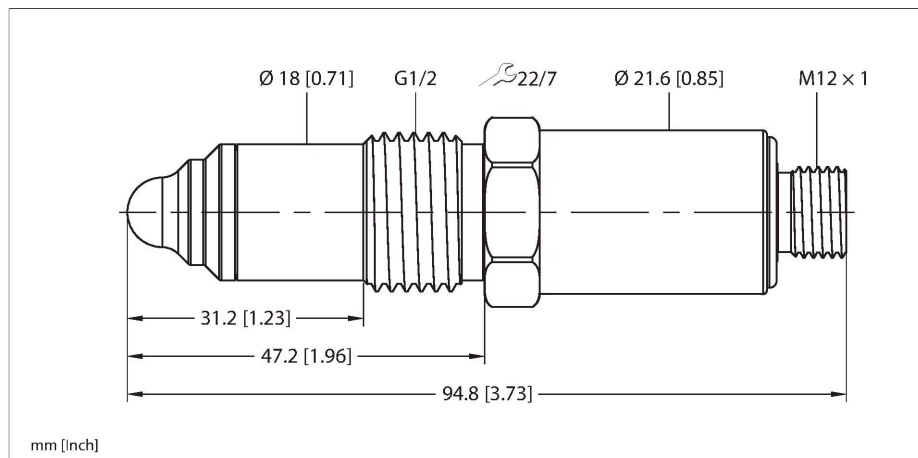

### Technical data

Type	NCLS-30-UP6X-H1141
ID no.	100004248
Secured operating distance	≤ (0.72 × Sn)
Mounting location	any
Installation information	Please use the NCLS limit level sensor only with original Turck process adapters!
Required permittivity (εr)	1.5
Pressure resistance	10 bar
Vacuum resistance	-1 bar
Temperature drift	type 20 %
Ambient temperature	-10...+70 °C
Medium temperature	0...+100 °C
Comment on the media temperature	0...+130 °C für <1 h bei einer Umgebungstemperatur von 40 °C
Storage temperature	-20...+70 °C
CIP/SIP-capable	yes
<b>Electrical data</b>	
Operating voltage	12...32 VDC
Power consumption	3 W
Switch-on time	< 0.3 s
Response time	< 0.2 s
Switching frequency	≤ 5 Hz
Isolation test voltage	≤ 0.5 kV
Communication protocol	IO-Link
SIO mode-compatible	Yes
Number of digital outputs	2
Output function	4-wire, NO/NC, PNP

### Features

- Media-contacting detection of limit levels in tanks and pipelines
- Detection of different substances (liquids, viscous materials, granular materials, powders)
- Hygienic PEEK tip, CIP/SIP-compatible
- EHEDG (submitted)
- Highly visible ring LED
- 12...32 VDC, < 1 W power consumption
- Two digital outputs, separately adjustable as NO/NC
- PNP, NPN or push-pull, switchable
- IO-Link for parameterization/process values
- Process connection G1/2" male thread, hygienic (in combination with TURCK adapters)
- 4-pin connector device, M12 × 1

### Wiring diagram

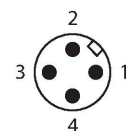
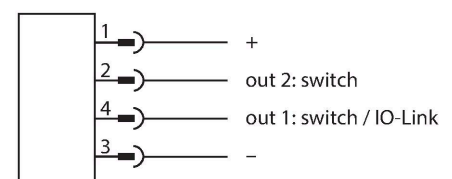

### Functional principle

Capacitive proximity switches are designed for wear-free detection of metal (electrically conductive) as well as non-metal (not electrically conductive) objects. A key feature

## Technical data

Short-circuit protection	yes
Wire breakage/Reverse polarity protection	yes / Complete
Insulation class	III
Approvals	CE EHEDG (submitted)
<b>IO-Link</b>	
IO-Link specification	V 1.1
Programming	FDT/DTM
Transmission physics	Corresponds to 3-wire physics (PHY2)
Transmission rate	COM 2/38.4 kbps
Process data width	16 bit
Measured value information	14 bit
Switchpoint information	2 bit
Frame type	2.2
Included in the SIDI GSDML	Yes
<b>Mechanical data</b>	
Design	Threaded barrel, G½"
Dimensions	94.8 x 22 x 22 mm
Housing material	Stainless steel, 1.4404 (AISI 316L)
Materials (contact with media)	Plastic, PEEK
Max. tightening torque of housing nut	20 Nm
Process connection	G 1/2" male thread, hygienic
Electrical connection	Connectors, M12 × 1
Vibration resistance	2 Hz (1 mm)
Shock resistance	7 g (11 ms)
Protection class	IP67 IP69K
MTTF	324 years acc. to SN 29500 (Ed. 99) 40 °C
Power-on indication	Ring LED, Green
Switching state	Ring LED, Green, (Reverse of operating voltage indicator)

of the NCLS limit level sensors is the ability to detect and differentiate between various liquids, viscous materials, granular materials and powders by making contact with the media. They are extremely well suited for detecting level limits (max./min.) and changes to the media in tanks and pipelines.

## Mounting instructions

## Product features

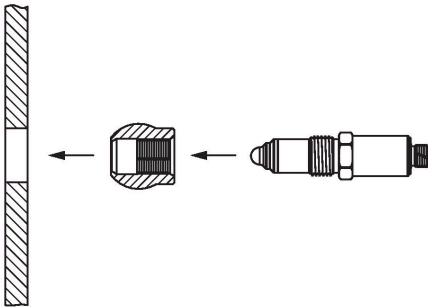

Please use the NCLS limit level sensor only with original Turck process adapters!

In principle, the sensor can be installed in any position and any location.

Mounting positions where deposits occur as a result of highly adhesive or viscous media or air pockets must be avoided.

A minimum distance of 15 mm must be maintained between the sensor tip and any adjacent objects (e.g. the wall of a container or pipe).

The relative permittivity ( $\epsilon_r$ ) of the medium must be  $>1.5$ .

## Accessories

### NCLS-WA0

100004429

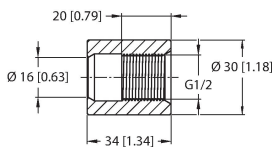

Cylindrical G1/2" welding sleeve process adaptor without control bore for NCLS capacitive limit level sensors, metallic sealing for hygienic applications, material 316L, max. temperature 140 °C

### NCLS-WA1

100004430

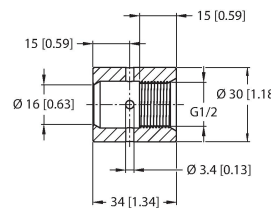

Cylindrical G1/2" welding sleeve process adaptor with control bore for NCLS capacitive limit level sensors, metallic sealing for hygienic applications, material 316L, max. temperature 140 °C

### NCLS-WA2

100004431

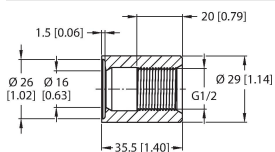

G1/2" weld collar sleeve process adaptor without control bore for NCLS capacitive limit level sensors, metallic sealing for hygienic applications, material 316L, max. temperature 140 °C

### NCLS-WA4

100004432

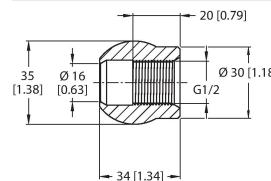

G1/2" ball sleeve process adaptor without control bore for NCLS capacitive limit level sensors, metallic sealing for hygienic applications, material 316L, max. temperature 140 °C

### NCLS-WA7

100004433

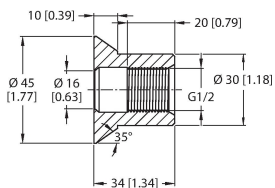

G1/2" welding sleeve process adaptor with collar for NCLS capacitive limit level sensors, metallic sealing for hygienic applications, material 316L, max. temperature 140 °C

### NCLS-VA

100004434

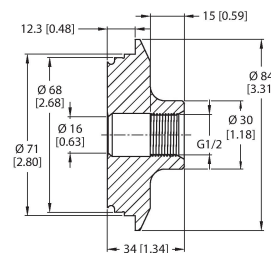

Varivent process adaptor G1/2" DN50 for NCLS capacitive limit level sensors, metallic sealing for hygienic applications, material 316L, max. temperature 140 °C

### NCLS-DF50

100004435

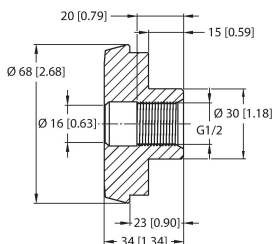

Dairy screw connection G1/2" process adaptor DN50 for NCLS capacitive limit level sensors, metallic sealing for hygienic applications, material 316L, max. temperature 140 °C

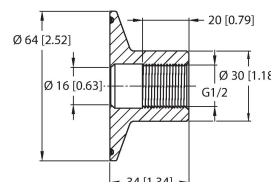

### NCLS-TC50

100004436

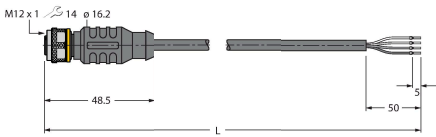
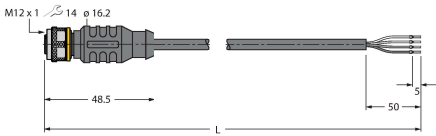

Triclamp G1/2" process adaptor DN50 for NCLS capacitive limit level sensors, metallic sealing for hygienic applications, material 316L, max. temperature 140 °C

## Accessories

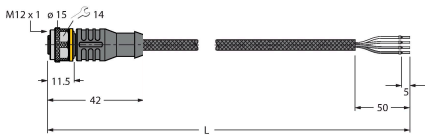
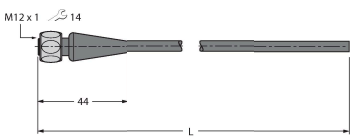
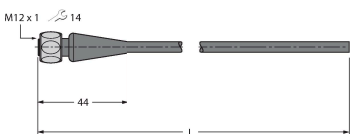
Dimension drawing	Type	ID no.	
	RKC4.4T-2/TEL	6625013	Connection cable, female M12, straight, 4-pin, cable length: 2 m, sheath material: PVC, black; cULus approval; other cable lengths and qualities available, see <a href="http://www.turck.com">www.turck.com</a>
	RKC4.4T-P7X2-2/TEL	6626162	Connection cable, M12 female, straight, 4-pin, 2 LED, cable length: 2 m, jacket material: PVC, black; cULus approval; other cable lengths and qualities available, see <a href="http://www.turck.com">www.turck.com</a>
	RKC4.4T-P7X2-2/TXL	6626795	Connection cable, M12 female, straight, 4-pin, 2 LED, cable length: 2 m, jacket material: PUR, black; cULus approval; other cable lengths and qualities available, see <a href="http://www.turck.com">www.turck.com</a>
	RKC4.4T-2/TXL	6627544	Connection cable, M12 female connector, straight, 4-pin, cable length: 2 m, jacket material: PUR, black; stainless steel coupling nut; cULus approval; other cable lengths and qualities available, see <a href="http://www.turck.com">www.turck.com</a>
	RKC4.4T-2/TXL1001	6628825	Connection cable, M12 connector, female, straight, 4-pin, cable length: 2 m, protective sheathing material: Aramid fibers, yellow; Temperature peak: 200 °C; other cable lengths and qualities available, see <a href="http://www.turck.com">www.turck.com</a>
	RKH4.4-2/TFE	6934473	Connection cable, M12 female, straight, 4-pin, stainless steel coupling nut, cable length: 2 m, jacket material: PVC, gray, temperature range -25...+80 °C; other cable lengths and designs available, see <a href="http://www.turck.com">www.turck.com</a>
	RKH4.4-2/TFG	6933086	Connection cable, M12 female, straight, 4-pin, stainless steel coupling nut, cable length: 2 m, jacket material: TPE, gray, temperature range -40...+105 °C; other cable lengths and designs available, see <a href="http://www.turck.com">www.turck.com</a>