



MIC29150/29300/29500/29750

High-Current Low-Dropout Regulators

General Description

The MIC29150/29300/29500/29750 are high current, high accuracy, low-dropout voltage regulators. Using Micrel's proprietary Super β PNP™ process with a PNP pass element, these regulators feature 300mV to 370mV (full load) dropout voltages and very low ground current. Designed for high current loads, these devices also find applications in lower current, extremely low dropout-critical systems, where their tiny dropout voltage and ground current values are important attributes.

The MIC29150/29300/29500/29750 are fully protected against overcurrent faults, reversed input polarity, reversed lead insertion, overtemperature operation, and positive and negative transient voltage spikes. Five pin fixed voltage versions feature logic level ON/OFF control and an error flag which signals whenever the output falls out of regulation. Flagged states include low input voltage (dropout), output current limit, overtemperature shutdown, and extremely high voltage spikes on the input.

On the MIC29xx1 and MIC29xx2, the ENABLE pin may be tied to V_{IN} if it is not required for ON/OFF control. The MIC29150/29300/29500 are available in 3- and 5-pin TO-220 and surface mount TO-263 packages. The MIC29750 7.5A regulators are available in 3- and 5-pin TO-247 packages.

For applications with input voltage 6V or below, see MIC3715x LDOs.

Features

- High current capability
MIC29150/29151/29152/29153 1.5A
MIC29300/29301/29302/29303 3A
MIC29500/29501/29502/29503 5A
MIC29750/29751/29752 7.5A
- Low-dropout voltage 350mV at Full Load
- Low ground current
- Accurate 1% guaranteed tolerance
- Extremely fast transient response
- Reverse-battery and "Load Dump" protection
- Zero-current shutdown mode (5-pin versions)
- Error flag signals output out-of-regulation (5-pin versions)
- Also characterized for smaller loads with industry-leading performance specifications
- Fixed voltage and adjustable versions

Applications

- Battery powered equipment
- High-efficiency "Green" computer systems
- Automotive electronics
- High-efficiency linear lower supplies
- High-efficiency lost-regulator for switching supply

Typical Application

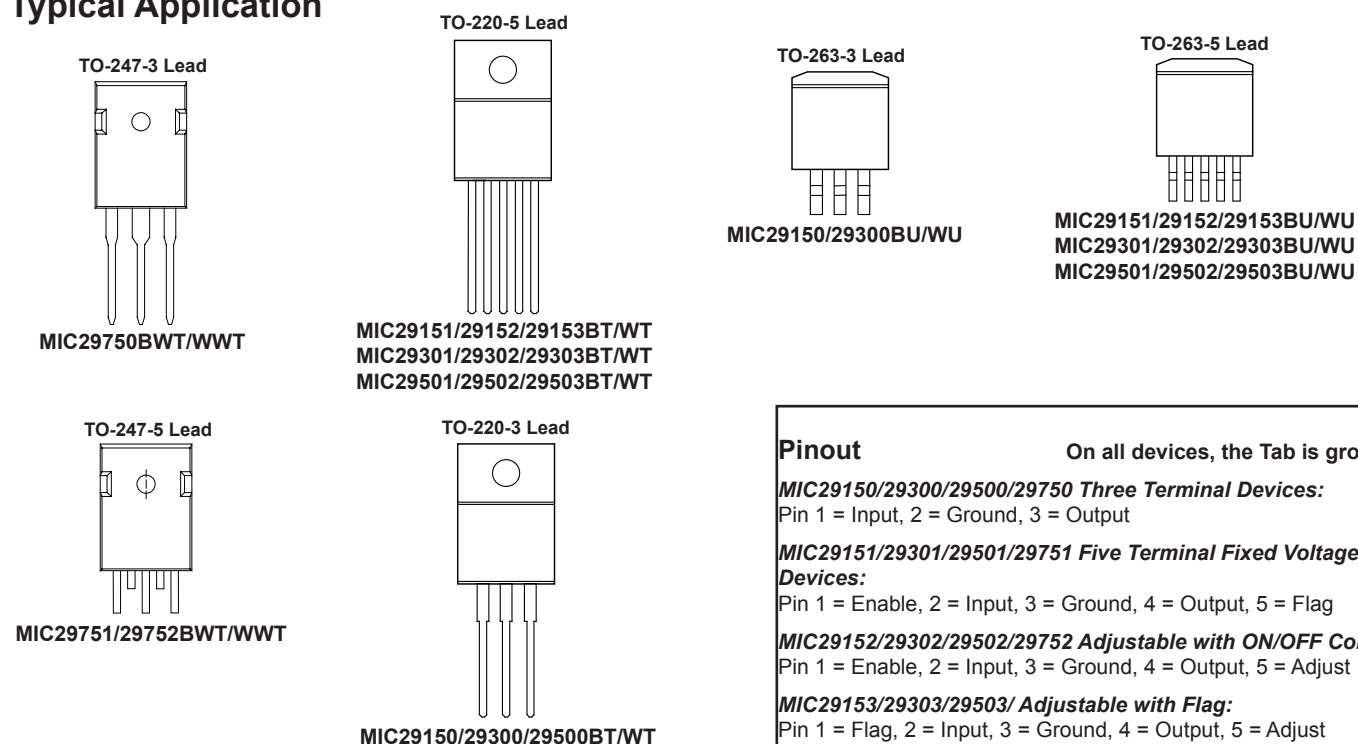

Pinout On all devices, the Tab is grounded.

MIC29150/29300/29500/29750 Three Terminal Devices:
Pin 1 = Input, 2 = Ground, 3 = Output

MIC29151/29301/29501/29751 Five Terminal Fixed Voltage Devices:
Pin 1 = Enable, 2 = Input, 3 = Ground, 4 = Output, 5 = Flag

MIC29152/29302/29502/29752 Adjustable with ON/OFF Control:
Pin 1 = Enable, 2 = Input, 3 = Ground, 4 = Output, 5 = Adjust

MIC29153/29303/29503/ Adjustable with Flag:
Pin 1 = Flag, 2 = Input, 3 = Ground, 4 = Output, 5 = Adjust

Super β PNP is a trademark of Micrel, Inc.

Ordering Information

Part Number		Temp. Range*	Voltage	Current	Package
Standard	RoHS Compliant**				
MIC29150-3.3BT	MIC29150-3.3WT**	-40°C to +125°C	3.3	1.5A	TO-220-3
MIC29150-3.3BU	MIC29150-3.3WU**	-40°C to +125°C	3.3	1.5A	TO-263-3
MIC29150-5.0BT	MIC29150-5.0WT**	-40°C to +125°C	5.0	1.5A	TO-220-3
MIC29150-5.0BU	MIC29150-5.0WU**	-40°C to +125°C	5.0	1.5A	TO-263-3
MIC29150-12BT	MIC29150-12WT**	-40°C to +125°C	12	1.5A	TO-220-3
MIC29150-12BU	MIC29150-12WU**	-40°C to +125°C	12	1.5A	TO-263-3
MIC29151-3.3BT	MIC29151-3.3WT**	-40°C to +125°C	3.3	1.5A	TO-220-5
MIC29151-3.3BU	MIC29151-3.3WU**	-40°C to +125°C	3.3	1.5A	TO-263-5
MIC29151-5.0BT	MIC29151-5.0WT**	-40°C to +125°C	5.0	1.5A	TO-220-5
MIC29151-5.0BU	MIC29151-5.0WU**	-40°C to +125°C	5.0	1.5A	TO-263-5
MIC29151-12BT	MIC29151-12WT**	-40°C to +125°C	12	1.5A	TO-220-5
MIC29151-12BU	MIC29151-12WU**	-40°C to +125°C	12	1.5A	TO-263-5
MIC29152BT	MIC29152WT**	-40°C to +125°C	Adj.	1.5A	TO-220-5
MIC29152BU	MIC29152WU**	-40°C to +125°C	Adj.	1.5A	TO-263-5
MIC29153BT***	Contact Factory	-40°C to +125°C	Adj.	1.5A	TO-220-5
MIC29153BU***	Contact Factory	-40°C to +125°C	Adj.	1.5A	TO-263-5
MIC29300-3.3BT	MIC29300-3.3WT**	-40°C to +125°C	3.3	3.0A	TO-220-3
MIC29300-3.3BU	MIC29300-3.3WU**	-40°C to +125°C	3.3	3.0A	TO-263-3
MIC29300-5.0BT	MIC29300-5.0WT**	-40°C to +125°C	5.0	3.0A	TO-220-3
MIC29300-5.0BU	MIC29300-5.0WU**	-40°C to +125°C	5.0	3.0A	TO-263-3
MIC29300-12BT	MIC29300-12WT**	-40°C to +125°C	12	3.0A	TO-220-3
MIC29300-12BU	MIC29300-12WU**	-40°C to +125°C	12	3.0A	TO-263-3
MIC29301-3.3BT	MIC29301-3.3WT**	-40°C to +125°C	3.3	3.0A	TO-220-5
MIC29301-3.3BU	MIC29301-3.3WU**	-40°C to +125°C	3.3	3.0A	TO-263-5
MIC29301-5.0BT	MIC29301-5.0WT**	-40°C to +125°C	5.0	3.0A	TO-220-5
MIC29301-5.0BU	MIC29301-5.0WU**	-40°C to +125°C	5.0	3.0A	TO-263-5
MIC29301-12BT	MIC29301-12WT**	-40°C to +125°C	12	3.0A	TO-220-5
MIC29301-12BU	MIC29301-12WU**	-40°C to +125°C	12	3.0A	TO-263-5
MIC29302BT	MIC29302WT**	-40°C to +125°C	Adj.	3.0A	TO-220-5
MIC29302BU	MIC29302WU**	-40°C to +125°C	Adj.	3.0A	TO-263-5
MIC29303BT	MIC29303WT**	-40°C to +125°C	Adj.	3.0A	TO-220-5
MIC29303BU	MIC29303WU**	-40°C to +125°C	Adj.	3.0A	TO-263-5
MIC29500-3.3BT	MIC29500-3.3WT**	-40°C to +125°C	3.3	5.0A	TO-220-3
MIC29500-5.0BT	MIC29500-5.0WT**	-40°C to +125°C	5.0	5.0A	TO-220-3
MIC29501-3.3BT	MIC29501-3.3WT**	-40°C to +125°C	3.3	5.0A	TO-220-5
MIC29501-3.3BU	MIC29501-3.3WU**	-40°C to +125°C	3.3	5.0A	TO-263-5
MIC29501-5.0BT	MIC29501-5.0WT**	-40°C to +125°C	5.0	5.0A	TO-220-5
MIC29501-5.0BU	MIC29501-5.0WU**	-40°C to +125°C	5.0	5.0A	TO-263-5
MIC29502BT	MIC29502WT**	-40°C to +125°C	Adj.	5.0A	TO-220-5
MIC29502BU	MIC29502WU**	-40°C to +125°C	Adj.	5.0A	TO-263-5
MIC29503BT	MIC29503WT**	-40°C to +125°C	Adj.	5.0A	TO-220-5
MIC29503BU	MIC29503WU**	-40°C to +125°C	Adj.	5.0A	TO-263-5
MIC29750-3.3BWT	Contact Factory	-40°C to +125°C	3.3	7.5A	TO-247-3
MIC29750-5.0BWT	Contact Factory	-40°C to +125°C	5.0	7.5A	TO-247-3
MIC29751-3.3BWT	Contact Factory	-40°C to +125°C	3.3	7.5A	TO-247-5
MIC29751-5.0BWT	Contact Factory	-40°C to +125°C	5.0	7.5A	TO-247-5
MIC29752BWT	MIC29752WWT**	-40°C to +125°C	Adj.	7.5A	TO-247-5

*Junction Temperature

**RoHS compliant with 'high-melting solder' exemption.

***Special Order, Contact Factory

Absolute Maximum Ratings

Power Dissipation.....	Internally Limited
Lead Temperature (Soldering, 5 seconds)	260°C
Storage Temperature Range	-65°C to +150°C
Input Supply Voltage ⁽¹⁾	-20V to +60V

Operating Ratings

Operating Junction Temperature	-40°C to +125°C
Maximum Operating Input Voltage	2.5V to 26V
TO-220 (θ_{JC})	2°C/W
TO-263 (θ_{JC})	2°C/W
TO-247 (θ_{JC})	1.5°C/W

Electrical Characteristics⁽¹²⁾

All measures at $T_A = 25^\circ\text{C}$ unless otherwise noted. **Bold** values are guaranteed across the operating temperature range. Adjustable versions are programmed to 5.0V.

Parameter	Condition	Min	Typ	Max	Units
Output Voltage	$I_O = 10\text{mA}$	-1		1	%
	$10\text{mA} \leq I_O \leq I_{FL}, (V_{OUT} + 1\text{V}) \leq V_{IN} \leq 26\text{V}$ ⁽²⁾	-2		2	%
Line Regulation	$I_O = 10\text{mA}, (V_{OUT} + 1\text{V}) \leq V_{IN} \leq 26\text{V}$		0.06	0.5	%
Load Regulation	$V_{IN} = V_{OUT} + 5\text{V}, 10\text{mA} \leq I_{OUT} \leq I_{FULL\ LOAD}$ ^(2,6)		0.2	1	%
$\frac{\Delta V_O}{\Delta T}$	Output Voltage ⁽⁶⁾ Temperature Coef.		20	100	ppm/°C
Dropout Voltage	$\Delta V_{OUT} = -1\%$ ⁽³⁾ MIC29150 $I_O = 100\text{mA}$ $I_O = 750\text{mA}$		80 220	200	mV
	MIC29300 $I_O = 1.5\text{A}$ $I_O = 100\text{mA}$ $I_O = 1.5\text{A}$		350 80 250	600 175	
	MIC29500 $I_O = 3\text{A}$ $I_O = 250\text{mA}$ $I_O = 2.5\text{A}$		370 125 250	600 250	
	MIC29750 $I_O = 5\text{A}$ $I_O = 250\text{mA}$ $I_O = 4\text{A}$ $I_O = 7.5\text{A}$		370 80 270 425	600 200 600	
Ground Current	MIC29150 $I_O = 750\text{mA}, V_{IN} = V_{OUT} + 1\text{V}$ $I_O = 1.5\text{A}$		8 22	20	mA
	MIC29300 $I_O = 1.5\text{A}, V_{IN} = V_{OUT} + 1\text{V}$ $I_O = 3\text{A}$		10 37	35	
	MIC29500 $I_O = 2.5\text{A}, V_{IN} = V_{OUT} + 1\text{V}$ $I_O = 5\text{A}$		15 70	50	
	MIC29750 $I_O = 4\text{A}, V_{IN} = V_{OUT} + 1\text{V}$ $I_O = 7.5\text{A}$		35 120	75	
I_{GRNDDO} Ground Pin Current at Droupout	$V_{IN} = 0.5\text{V}$ less than specified $V_{OUT} \cdot I_{OUT} = 10\text{mA}$ MIC29150 MIC29300 MIC29500 MIC29750		0.9 1.7 2.1 3.1		mA mA mA mA
Current Limit	MIC29150 $V_{OUT} = 0\text{V}$ ⁽⁴⁾		2.1	3.5	A
	MIC29300 $V_{OUT} = 0\text{V}$ ⁽⁴⁾		4.5	5.0	A
	MIC29500 $V_{OUT} = 0\text{V}$ ⁽⁴⁾		7.5	10.0	A
	MIC29750 $V_{OUT} = 0\text{V}$ ⁽⁴⁾		9.5	15	A
e_n , Output Noise Voltage (10Hz to 100kHz) $I_L = 100\text{mA}$	$C_L = 10\mu\text{F}$		400		μV (rms)
	$C_L = 33\mu\text{F}$		260		
Ground Current in Shutdown	MIC29150/1/2/3 only $V_{EN} = 0.4\text{V}$		2	10 30	μA μA

Parameter	Condition	Min	Typ	Max	Units
Reference	MIC29xx2/MIC29xx3				
Reference Voltage		1.228 1.215	1.240	1.252 1.265	V V max
Reference Voltage	(8)	1.203		1.277	V
Adjust Pin Bias Current			40	80 120	nA
Reference Voltage Temperature Coefficient	(7)		20		ppm/°C
Adjust Pin Bias Current Temperature Coefficient			0.1		nA/°C

Flag Output (Error Comparator) MIC29xx1/29xx3

Output Leakage Current	$V_{OH} = 26V$		0.01	1.00 2.00	μA
Output Low Voltage	Device set for 5V, $V_{IN} = 4.5V$ $I_{OL} = 250\mu A$		220	300 400	mV
Upper Threshold Voltage	Device set for 5V (9)	40 25	60		mV
Lower Threshold Voltage	Device set for 5V (9)		75	95 140	mV
Hysteresis	Device set for 5V (9)		15		mV

ENABLE Input MIC29xx1/MIC29xx2

Input Logic Voltage Low (OFF) High (ON)		2.4		0.8	V
Enable Pin Input Current	$V_{EN} = 26V$		100	600 750	μA
	$V_{EN} = 0.8V$	0.7		2 4	μA
Regulator Output Current in Shutdown	(10)		10	500	μA

Notes:

- Maximum positive supply voltage of 60V must be of limited duration (<100msec) and duty cycle ($\leq 1\%$). The maximum continuous supply voltage is 26V.
- Full load current (I_{FL}) is defined as 1.5A for the MIC29150, 3A for the MIC29300, 5A for the MIC29500, and 7.5A for the MIC29750 families.
- Dropout voltage is defined as the input-to-output differential when the output voltage drops to 99% of its normal value with $V_{OUT} + 1V$ applied to V_{IN} .
- $V_{IN} = V_{OUT} (\text{nominal}) + 1V$. For example, use $V_{IN} = 4.3V$ for a 3.3V regulator or use 6V for a 5V regulator. Employ pulse-testing procedures to pin current.
- Ground pin current is the regulator quiescent current. The total current drawn from the source is the sum of the load current plus the ground pin current.
- Output voltage temperature coefficient is defined as the worst case voltage change divided by the total temperature range.
- Thermal regulation is defined as the change in output voltage at a time T after a change in power dissipation is applied, excluding load or line regulation effects. Specifications are for a 200mA load pulse at $V_{IN} = 20V$ (a 4W pulse) for $T = 10ms$.
- $V_{REF} \leq V_{OUT} \leq (V_{IN} - 1V)$, $2.3V \leq V_{IN} \leq 26V$, $10mA < I_L \leq I_{FL}$, $T_J \leq T_{JMAX}$.
- Comparator thresholds are expressed in terms of a voltage differential at the Adjust terminal below the nominal reference voltage measured at 6V input. To express these thresholds in terms of output voltage change, multiply by the error amplifier gain = $V_{OUT}/V_{REF} = (R1 + R2)/R2$. For example, at a programmed output voltage of 5V, the Error output is guaranteed to go low when the output drops by $95mV \times 5V/1.240V = 384mV$. Thresholds remain constant as a percent of V_{OUT} as V_{OUT} is varied, with the dropout warning occurring at typically 5% below nominal, 7.7% guaranteed.
- $V_{EN} \leq 0.8V$ and $V_{IN} \leq 26V$, $V_{OUT} = 0$.
- When used in dual supply systems where the regulator load is returned to a negative supply, the output voltage must be diode clamped to ground.
- Specification for packaged product only.

Block Diagram

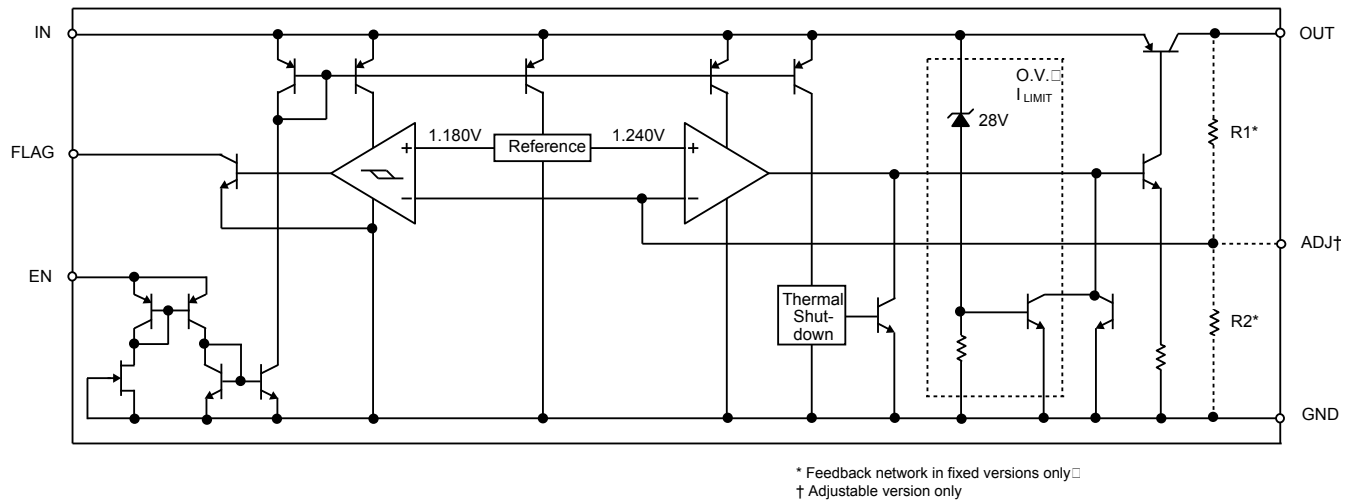

Typical Applications

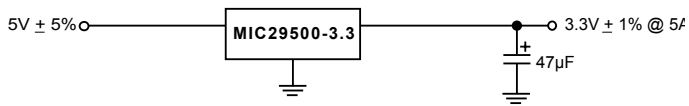

Figure 1. Fixed Output Voltage

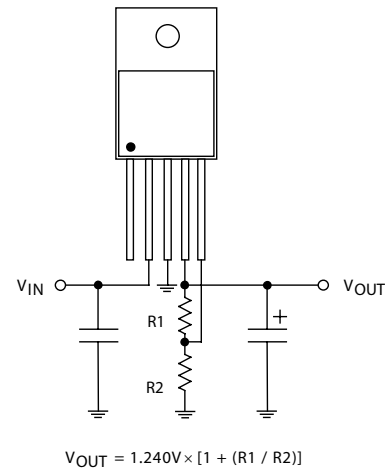
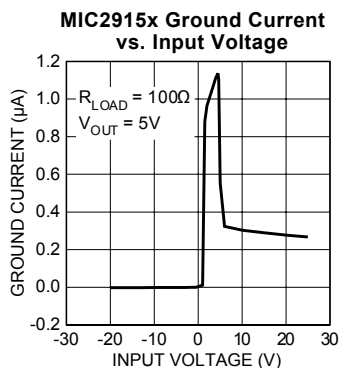
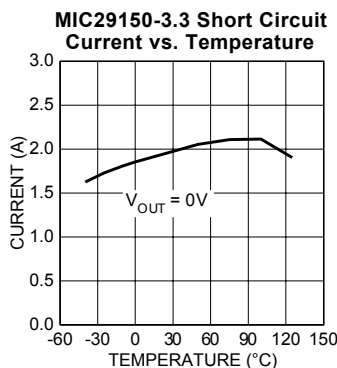
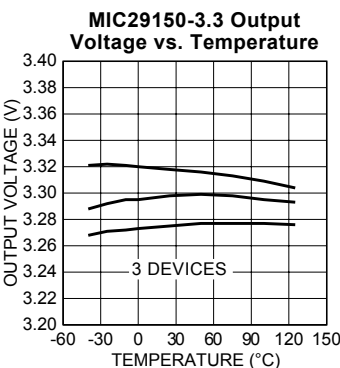
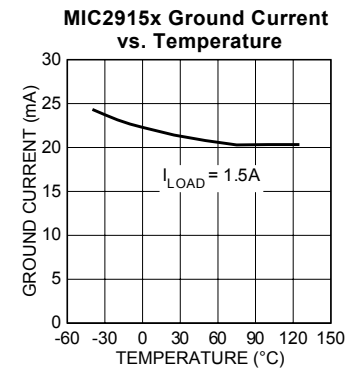
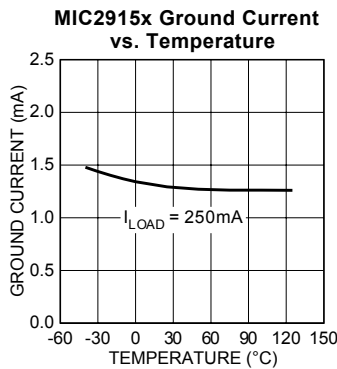
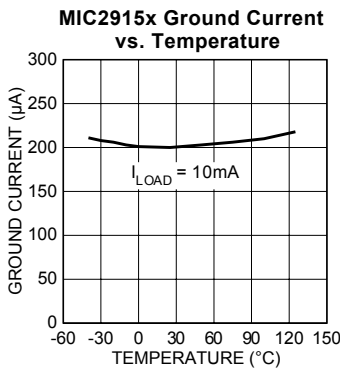
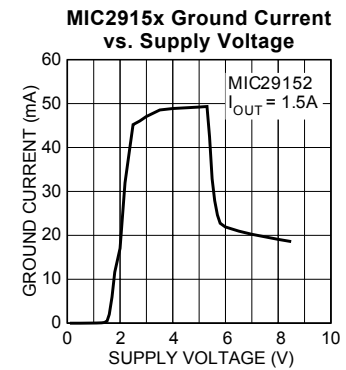
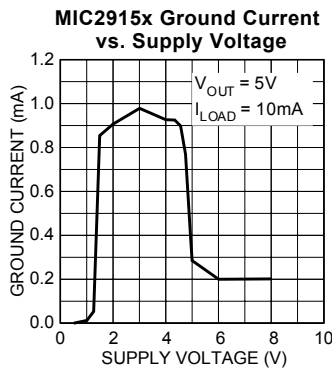
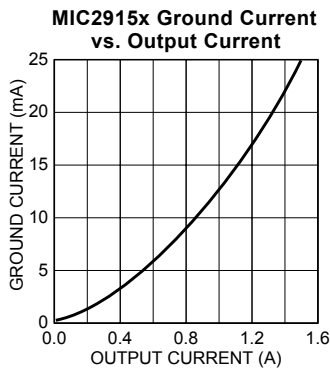
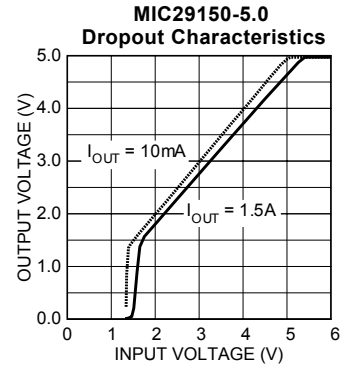
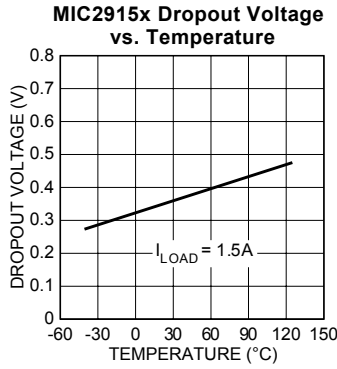
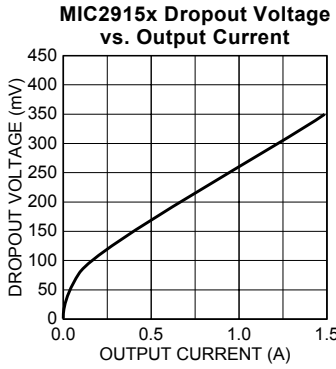
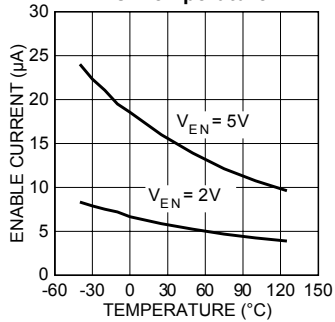

Figure 2. Adjustable output Voltage Configuration. For best results, the total series resistance should be small enough to pass the minimum regulator load current.

Typical Characteristics MIC2915x



MIC29151-xx/2 Enable Current vs. Temperature



MIC2915x Load Transient

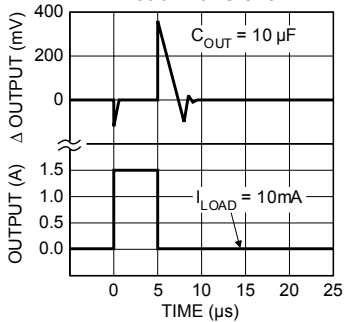

MIC2915x Load Transient

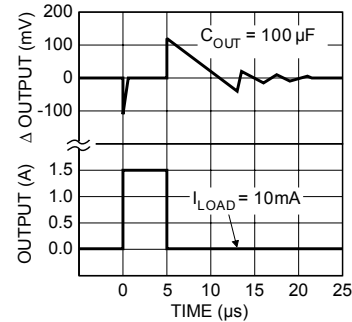

MIC29152/3 Adjust Pin Current vs. Temperature

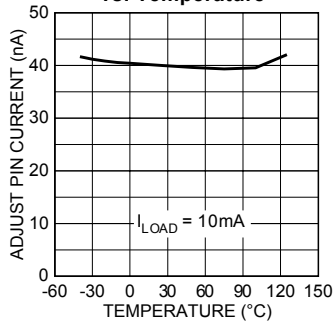

MIC2915x Line Transient

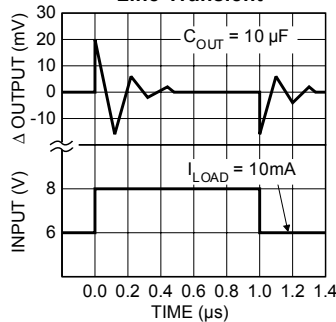

MIC2915x Line Transient

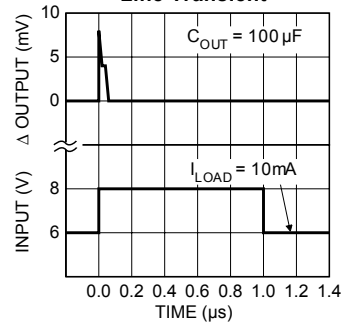

MIC2915x Output Impedance vs. Frequency

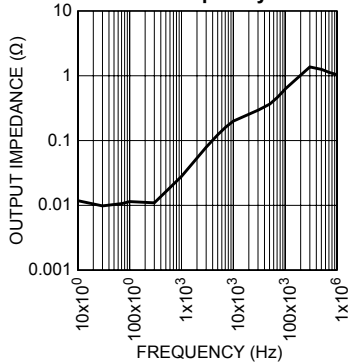

Typical Characteristics MIC2930x

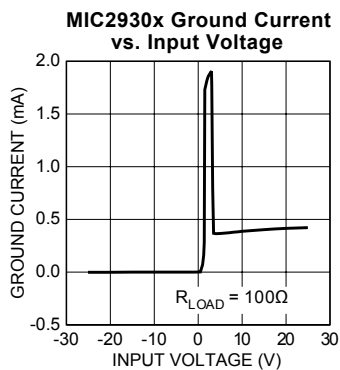
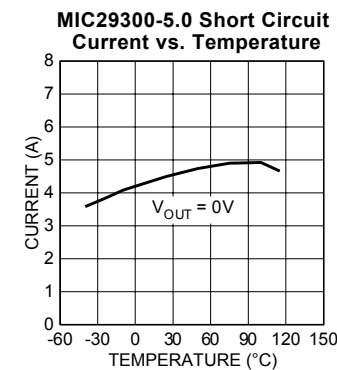
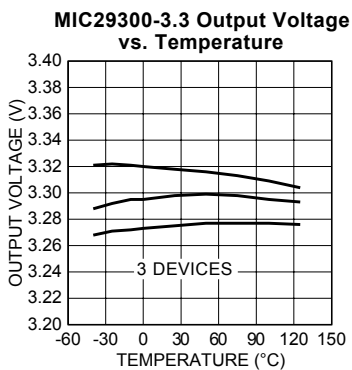
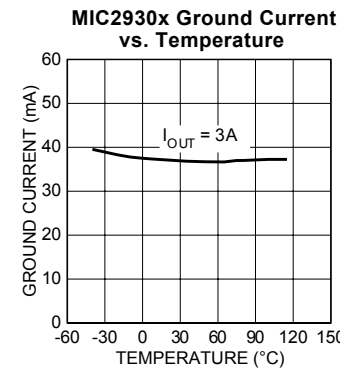
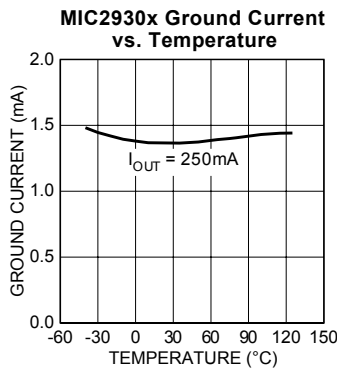
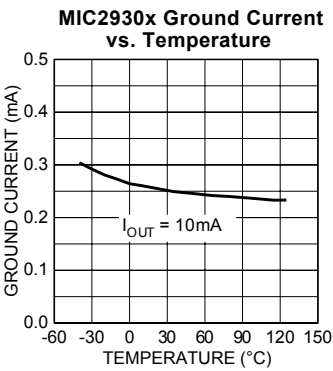
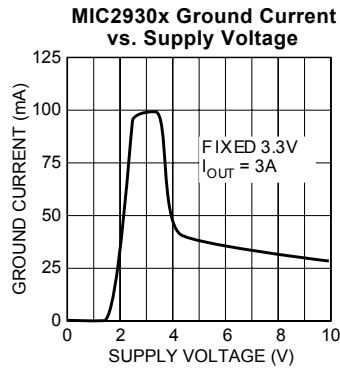
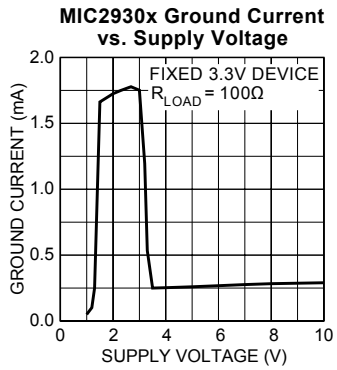
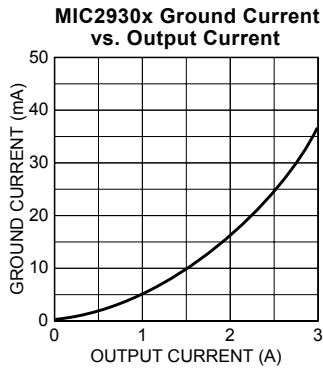
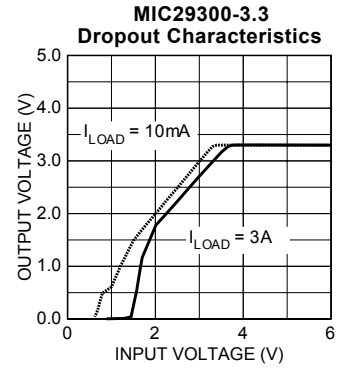
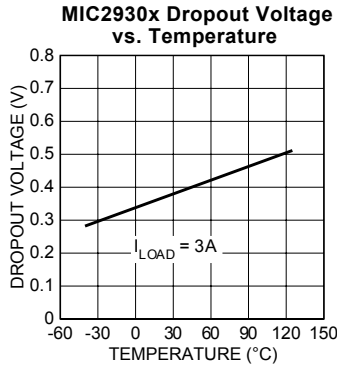
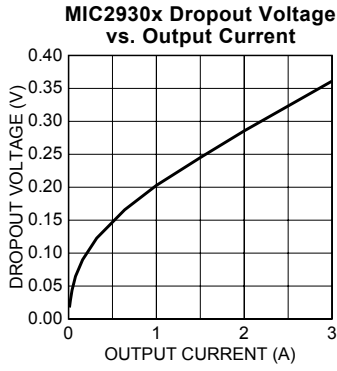

MIC29301-xx/2 Enable Current vs. Temperature

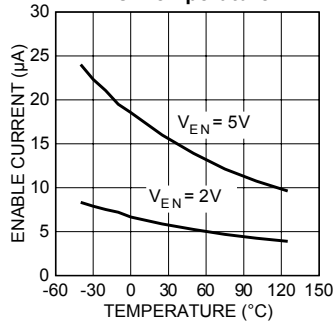

MIC2930x Load Transient

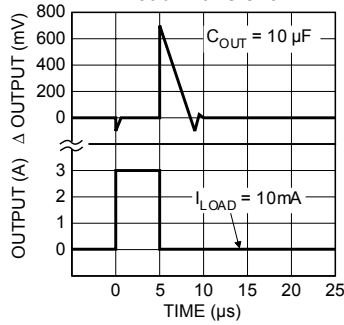

MIC2930x Load Transient

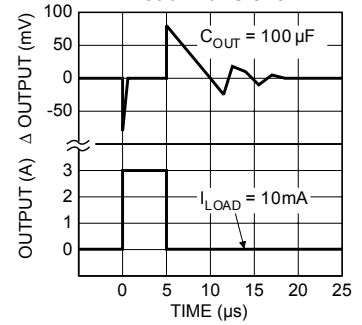

MIC29302/3 Adjust Pin Current vs. Temperature

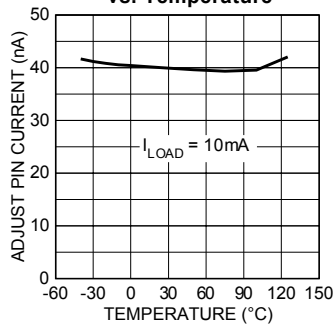

MIC2930x Line Transient

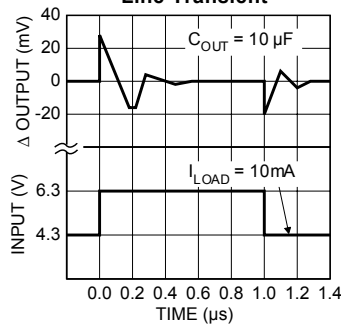

MIC2930x Line Transient

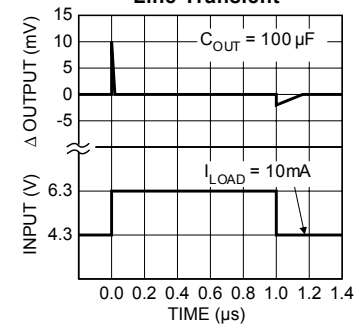

MIC2930x Output Impedance vs. Frequency

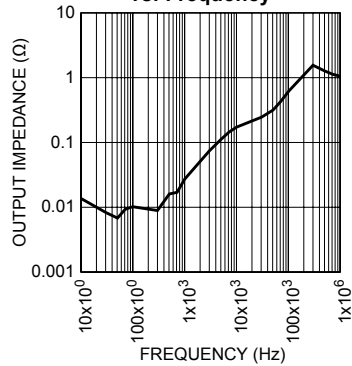

Typical Characteristics MIC2950x

MIC2950x Dropout Voltage vs. Output Current

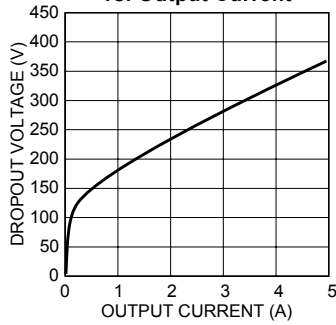

MIC2950x Dropout Voltage vs. Temperature

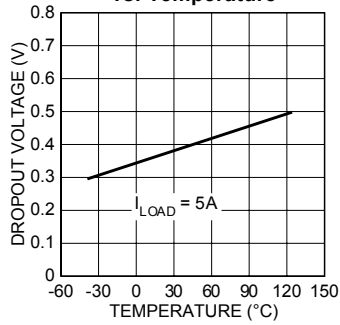

MIC29500-3.3 Dropout Characteristics

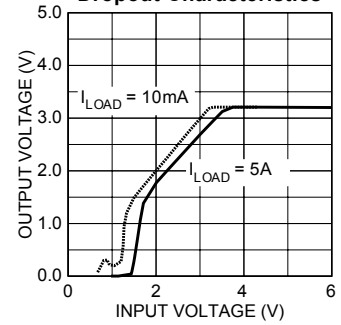

MIC2950x Ground Current vs. Output Current

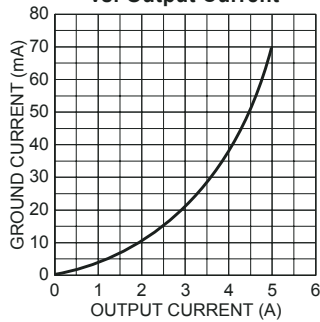

MIC2950x Ground Current vs. Supply Voltage

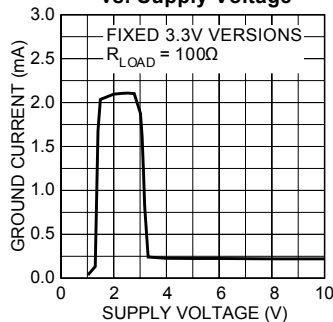

MIC2950x Ground Current vs. Supply Voltage

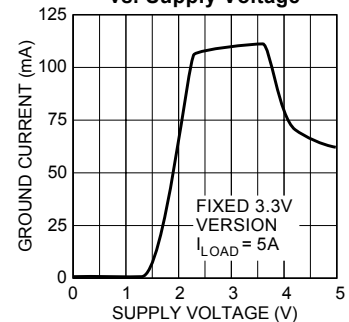

MIC2950x Ground Current vs. Temperature

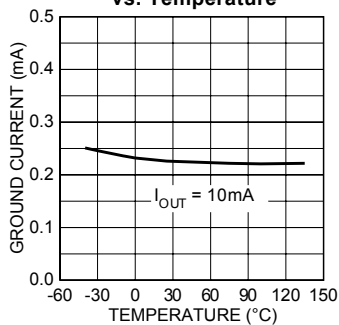

MIC2950x Ground Current vs. Temperature

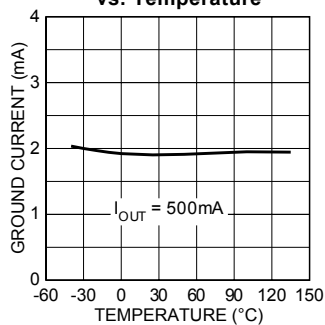

MIC2950x Ground Current vs. Temperature

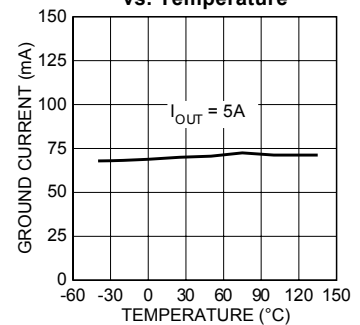

MIC29500-3.3 Output Voltage vs. Temperature

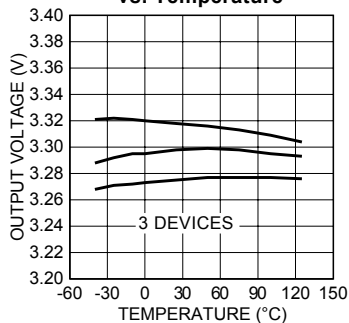

MIC2950x-5.0 Short Circuit Current vs. Temperature

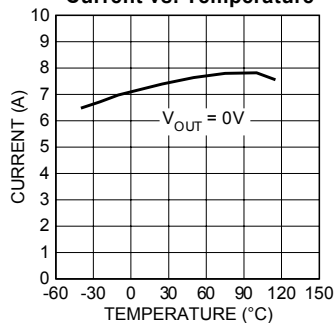

MIC2950x Ground Current vs. Input Voltage

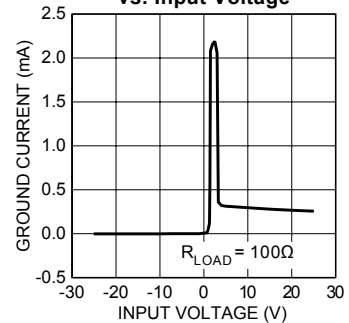

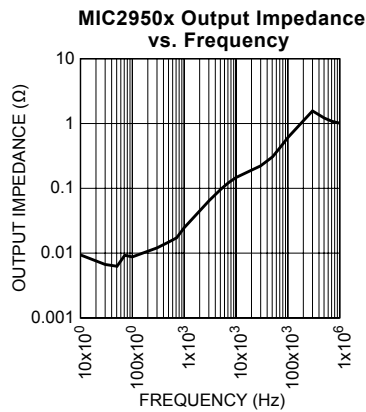
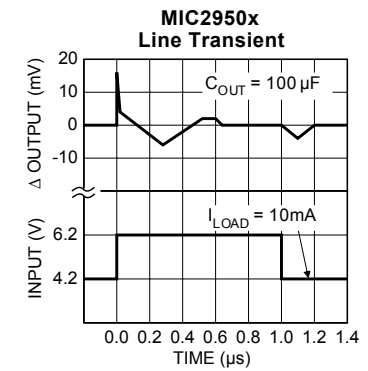
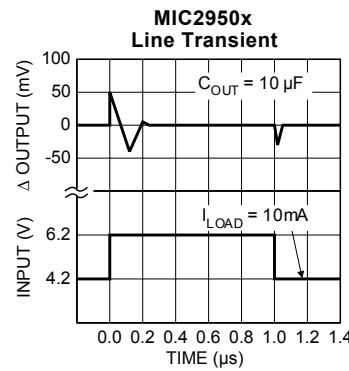
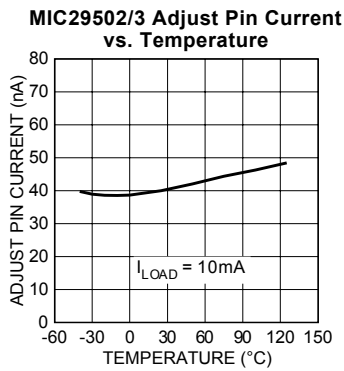
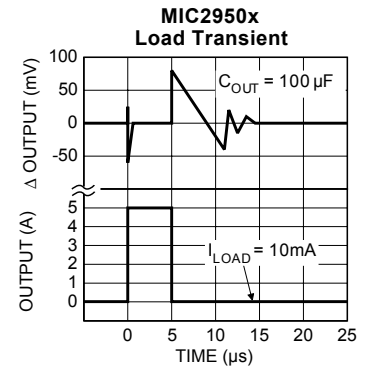
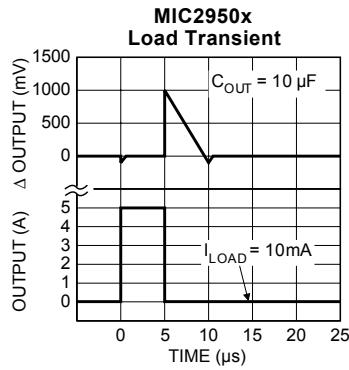
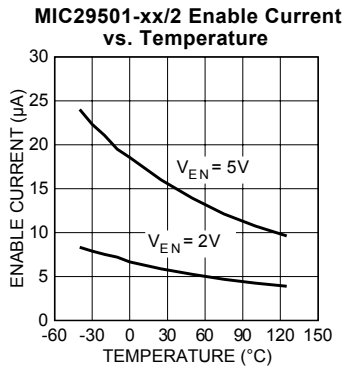

Typical Characteristics MIC2975x

MIC2975x Dropout Voltage vs. Output Current

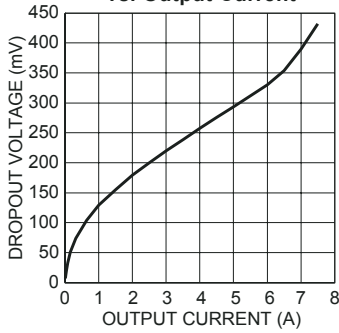

MIC2975x Dropout Voltage vs. Temperature

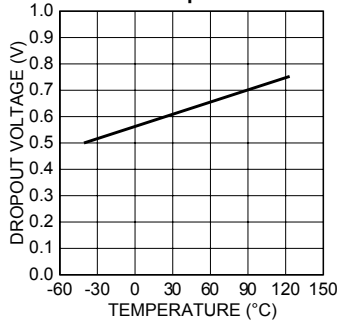

MIC29750-3.3 Dropout Characteristics

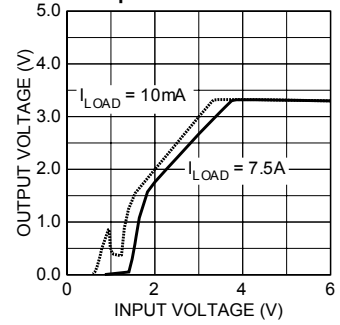

MIC2975x Ground Current vs. Output Current

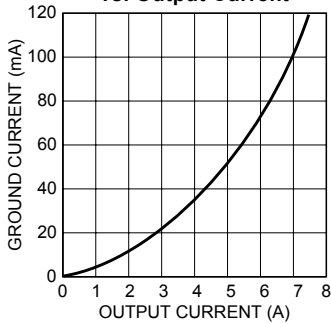

MIC2975x Ground Current vs. Supply Voltage

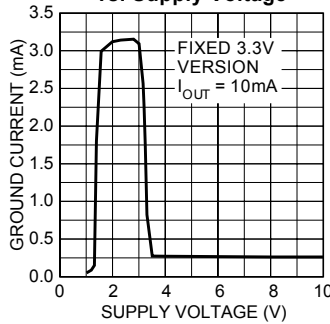

MIC2975x Ground Current vs. Supply Voltage

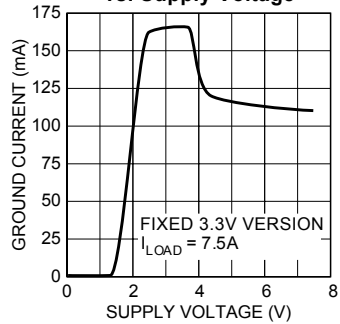

MIC2975x Ground Current vs. Temperature

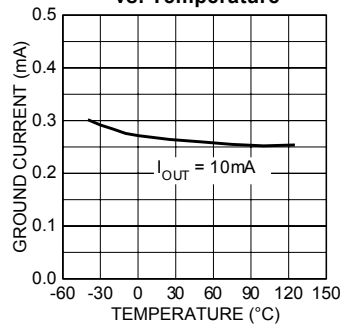

MIC2975x Ground Current vs. Temperature

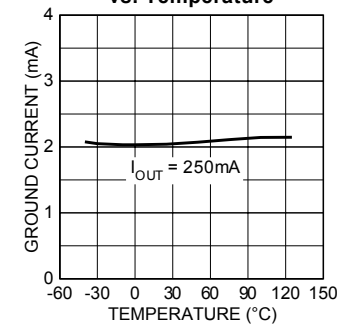

MIC2975x Ground Current vs. Temperature

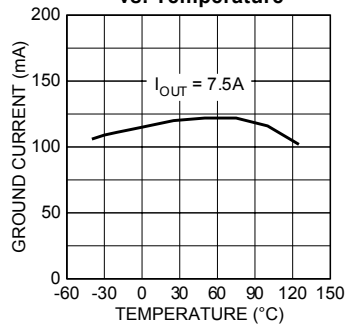

MIC29750-3.3 Output Voltage vs. Temperature

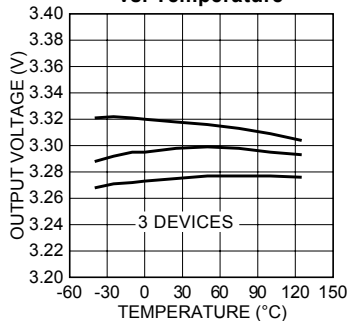

MIC29750-5.0 Short Circuit Current vs. Temperature

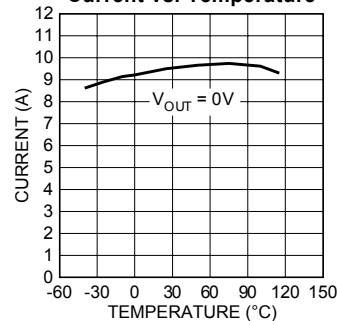

MIC2975x Ground Current vs. Input Voltage

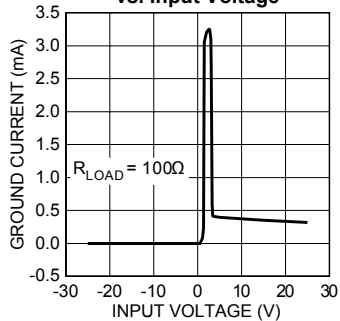

MIC29751-xx/2 Enable Current vs. Temperature

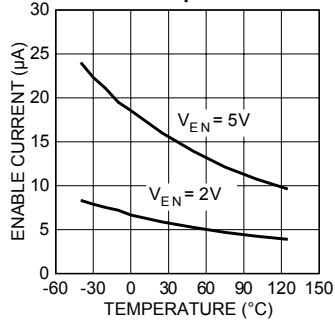

MIC2975x Load Transient

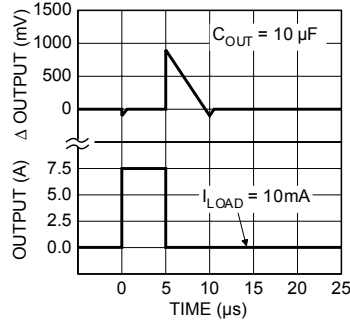

MIC2975x Load Transient

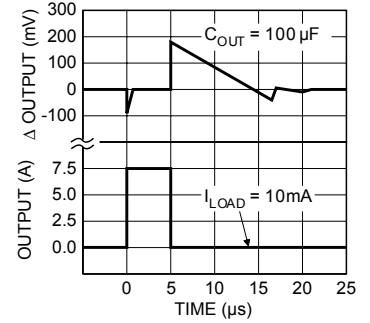

MIC29752/3 Adjust Pin Current vs. Temperature

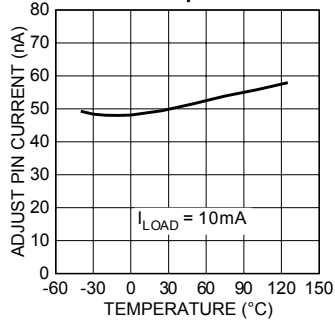

MIC2975x Line Transient

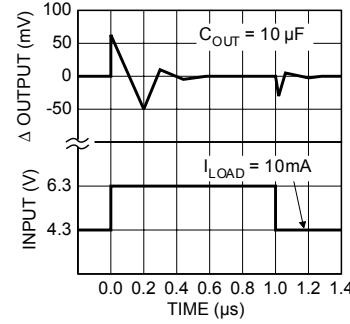

MIC2975x Line Transient

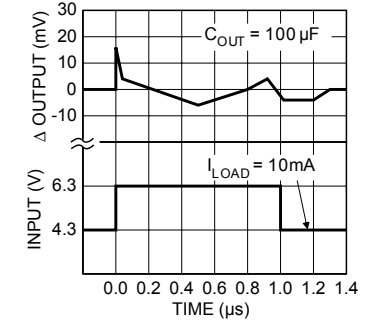

MIC2975x Output Impedance vs. Frequency

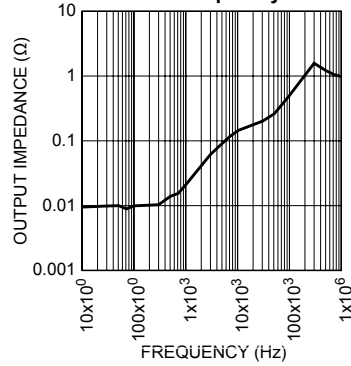

Applications Information

The MIC29150/29300/29500/29750 are high performance low-dropout voltage regulators suitable for all moderate to high-current voltage regulator applications. Their 300mV to 400mV dropout voltage at full load make them especially valuable in battery powered systems and as high efficiency noise filters in “post-regulator” applications. Unlike older NPN-pass transistor designs, where the minimum dropout voltage is limited by the base-emitter voltage drop and collector-emitter saturation voltage, dropout performance of the PNP output of these devices is limited merely by the low V_{CE} saturation voltage.

A trade-off for the low-dropout voltage is a varying base driver requirement. But Micrel’s Super β PNP™ process reduces this drive requirement to merely 1% of the load current.

The MIC29150–29750 family of regulators is fully protected from damage due to fault conditions. Current limiting is provided. This limiting is linear; output current under overload conditions is constant. Thermal shutdown disables the device when the die temperature exceeds the 125°C maximum safe operating temperature. Transient protection allows device (and load) survival even when the input voltage spikes between –20V and +60V. When the input voltage exceeds about 35V to 40V, the over voltage sensor temporarily disables the regulator. The output structure of these regulators allows voltages in excess of the desired output voltage to be applied without reverse current flow. MIC29xx1 and MIC29xx2 versions offer a logic level ON/OFF control: when disabled, the devices draw nearly zero current.

An additional feature of this regulator family is a common pin-out: a design’s current requirement may change up or down yet use the same board layout, as all of these regulators have identical pinouts.

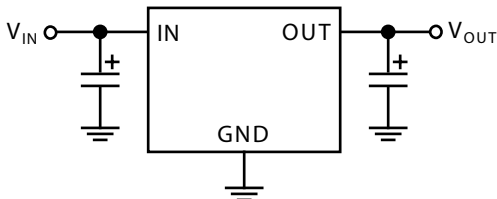

Figure 3. Linear regulators require only two capacitors for operation.

Thermal Design

Linear regulators are simple to use. The most complicated design parameters to consider are thermal characteristics. Thermal design requires the following application-specific parameters:

- Maximum ambient temperature, T_A
- Output Current, I_{OUT}
- Output Voltage, V_{OUT}
- Input Voltage, V_{IN}

First, we calculate the power dissipation of the regulator from these numbers and the device parameters from this datasheet.

$$P_D = I_{OUT} (1.01 V_{IN} - V_{OUT})$$

Where the ground current is approximated by 1% of I_{OUT} . Then the heat sink thermal resistance is determined with this formula:

$$\theta_{SA} = \frac{T_{JMAX} - T_A}{P_D} - (\theta_{JC} + \theta_{CS})$$

Where $T_{JMAX} \leq 125^\circ\text{C}$ and θ_{CS} is between 0 and 2°C/W .

The heat sink may be significantly reduced in applications where the minimum input voltage is known and is large compared with the dropout voltage. Use a series input resistor to drop excessive voltage and distribute the heat between this resistor and the regulator. The low-dropout properties of Micrel Super β PNP regulators allow very significant reductions in regulator power dissipation and the associated heat sink without compromising performance. When this technique is employed, a capacitor of at least $0.1\mu\text{F}$ is needed directly between the input and regulator ground.

Please refer to Application Note 9 and Application Hint 17 for further details and examples on thermal design and heat sink specification.

Capacitor Requirements

For stability and minimum output noise, a capacitor on the regulator output is necessary. The value of this capacitor is dependent upon the output current; lower currents allow smaller capacitors. MIC29150–29750 regulators are stable with the following minimum capacitor values at full load:

Device	Full Load Capacitor
MIC29150.....	10 μF
MIC29300.....	10 μF
MIC29500.....	10 μF
MIC29750.....	22 μF

This capacitor need not be an expensive low ESR type: aluminum electrolytics are adequate. In fact, extremely low ESR capacitors may contribute to instability. Tantalum capacitors are recommended for systems where fast load transient response is important.

Where the regulator is powered from a source with a high AC impedance, a $0.1\mu\text{F}$ capacitor connected between Input and GND is recommended. This capacitor should have good characteristics to above 250kHz.

Minimum Load Current

The MIC29150–29750 regulators are specified between finite loads. If the output current is too small, leakage currents dominate and the output voltage rises. The following minimum load current swamps any expected leakage current across the operating temperature range:

Device	Minimum Load
MIC29150.....	5mA
MIC29300.....	7mA
MIC29500.....	10mA
MIC29750.....	10mA

Two resistors are used. Resistors can be quite large, up to 1MΩ, because of the very high input impedance and low bias current of the sense comparator: The resistor values are calculated by:

$$R_1 = R_2 \left(\frac{V_{OUT}}{1.240} - 1 \right)$$

Where V_O is the desired output voltage. Figure 4 shows component definition. Applications with widely varying load currents may scale the resistors to draw the minimum load current required for proper operation (see above).

Adjustable Regulator Design

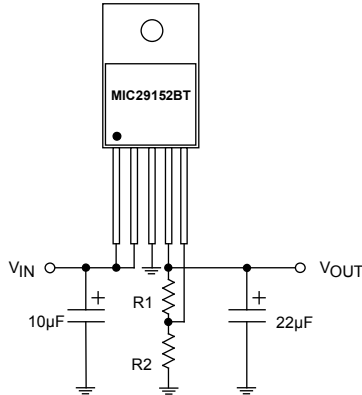

Figure 4. Adjustable Regulator with Resistors

The adjustable regulator versions, MIC29xx2 and MIC29xx3, allow programming the output voltage anywhere between 1.25V and the 26V maximum operating rating of the family.

Error Flag

MIC29xx1 and MIC29xx3 versions feature an Error Flag, which looks at the output voltage and signals an error condition when this voltage drops 5% below its expected value. The error flag is an open-collector output that pulls low under fault conditions. It may sink 10mA. Low output voltage signifies a number of possible problems, including an overcurrent fault (the device is in current limit) and low input voltage. The flag output is inoperative during overtemperature shutdown conditions.

Enable Input

MIC29xx1 and MIC29xx2 versions feature an enable (EN) input that allows ON/OFF control of the device. Special design allows “zero” current drain when the device is disabled—only microamperes of leakage current flows. The EN input has TTL/CMOS compatible thresholds for simple interfacing with logic, or may be directly tied to ≤ 30V. Enabling the regulator requires approximately 20µA of current.

Package Information

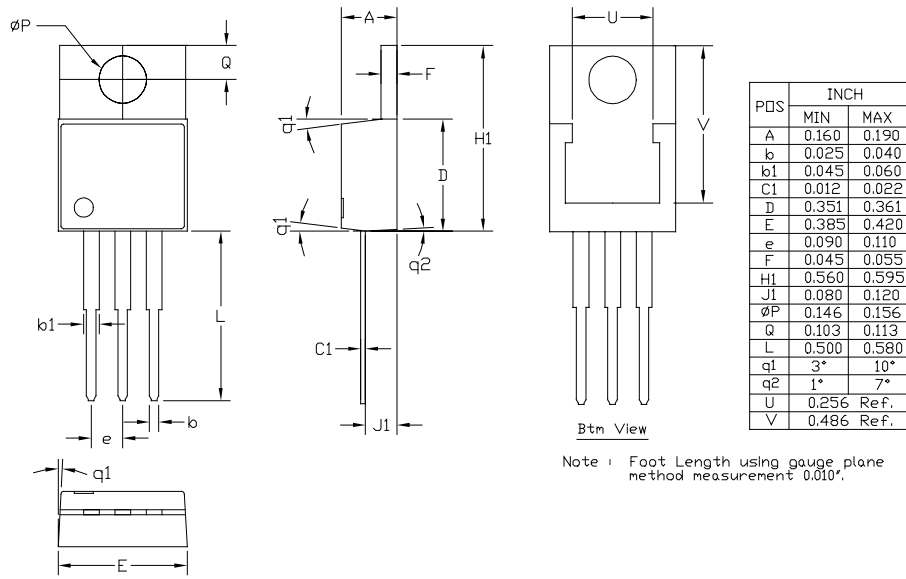

3-Lead TO-220 (T)

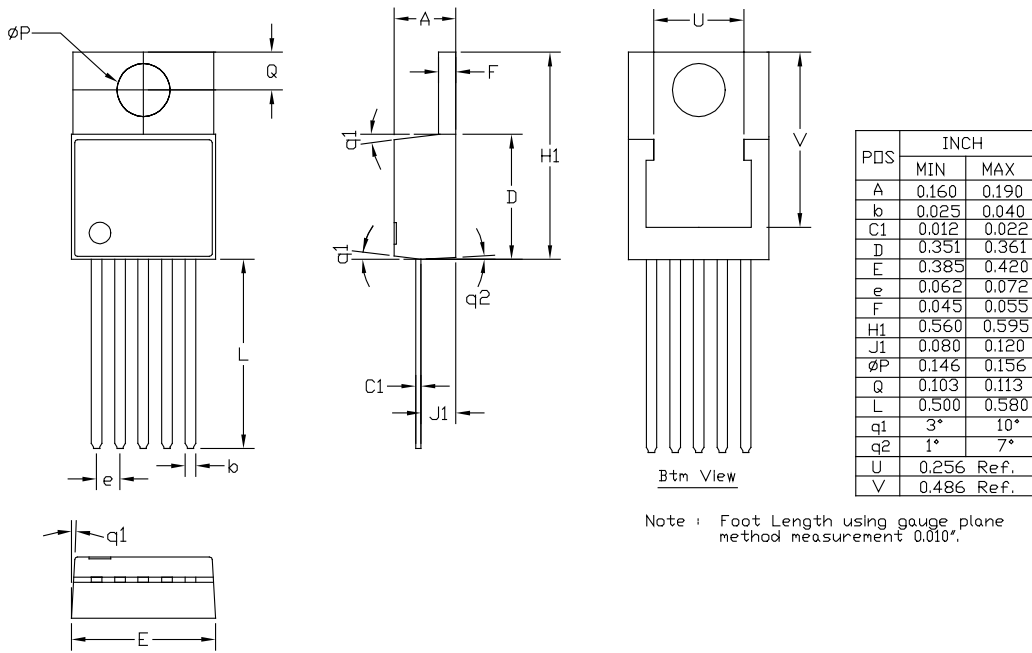

5-Lead TO-220 (T)

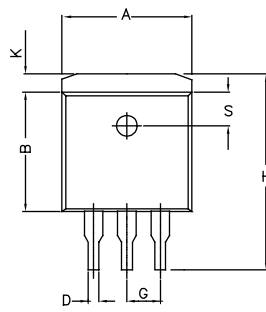

TOP VIEW

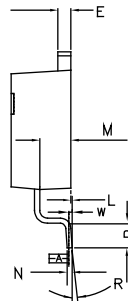

SIDE VIEW 1

POS	INCHES		MILLIMETERS	
	MIN	MAX	MIN	MAX
A	.396	.406	10.05	10.31
B	.350	.340	8.38	8.64
C	.170	.180	4.31	4.57
D	.026	.036	0.66	0.91
E	.046	.055	1.14	1.40
G	0.100 ref		1.27 ref	
H	.080	.620	14.73	15.75
K	.055	.066	1.40	1.68
L	.000	.010	0.00	0.25
M	.098	.108	2.49	2.74
N	.017	.023	0.43	0.58
P	.090	.110	2.29	2.79
R	0°	8°	0°	8°
β	.095	.105	2.41	2.67
U	.30 ref		7.62 ref	
V	.305 ref		7.75 ref	
W	.010		0.25	

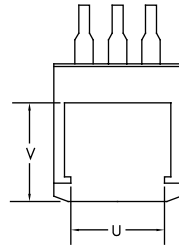

BOTTOM VIEW

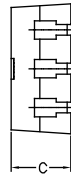

SIDE VIEW 2

NOTE:

1. PACKAGE OUTLINE EXCLUSIVE OF MOLD FLASH & METAL BURR.
2. PACKAGE OUTLINE INCLUSIVE OF PLATING THICKNESS.
3. FOOT LENGTH MEASURED AT INTERCEPT POINT BETWEEN DATUM A & LEAD SURFACE.

3-Lead TO-263 (U)

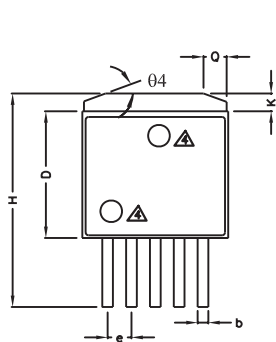

TOP VIEW

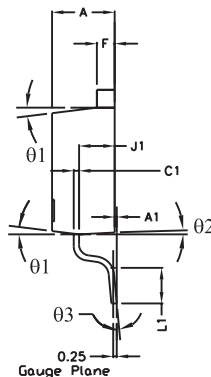

SIDE VIEW 1

POS	INCH		MM	
	MIN	MAX	MIN	MAX
A	0.170	0.181	4.318	4.597
A1	0.000	0.012	0.000	0.305
b	0.026	0.036	0.660	0.914
C1	0.012	0.023	0.305	0.584
D	0.330	0.361	8.382	9.169
E	0.396	0.420	10.058	10.668
e	0.062	0.072	1.575	1.829
F	0.045	0.055	1.143	1.397
H	0.575	0.625	14.605	15.875
J1	0.080	0.120	2.032	3.048
K	0.045	0.066	1.143	1.676
L1	0.090	0.110	2.286	2.794
θ1	3°	10°	3°	10°
θ2	1°	7°	1°	7°
θ3	0°	8°	0°	8°
θ4	18°	22°	18°	22°
Q	0.055	0.075	1.397	1.905
U	0.256 Ref.		6.502 Ref.	
V	0.305 Ref.		7.747 Ref.	

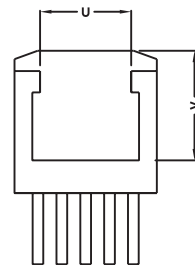

BOTTOM VIEW

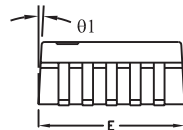

SIDE VIEW 2

NOTE:

1. PACKAGE OUTLINE EXCLUSIVE OF MOLD FLASH & METAL BURR.
 2. PACKAGE OUTLINE INCLUSIVE OF PLATING THICKNESS.
 3. FOOT LENGTH USING GAUGE PLANE METHOD MEASUREMENT 0.010"
- ▲ PACKAGE TOP MARK MAY BE IN TOP CENTER OR LOWER LEFT CORNER

5-Lead TO-263 (U)

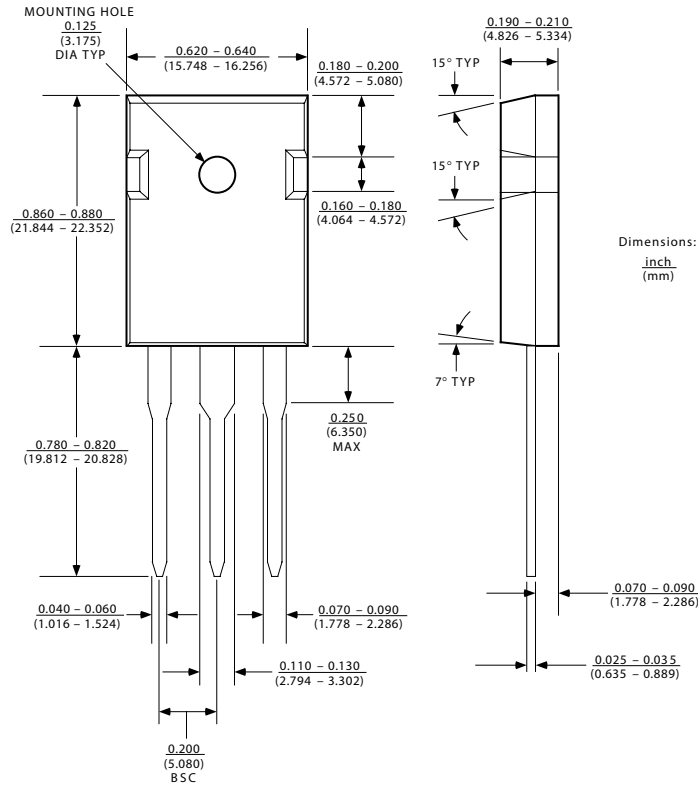

3-Lead TO-247 (W)

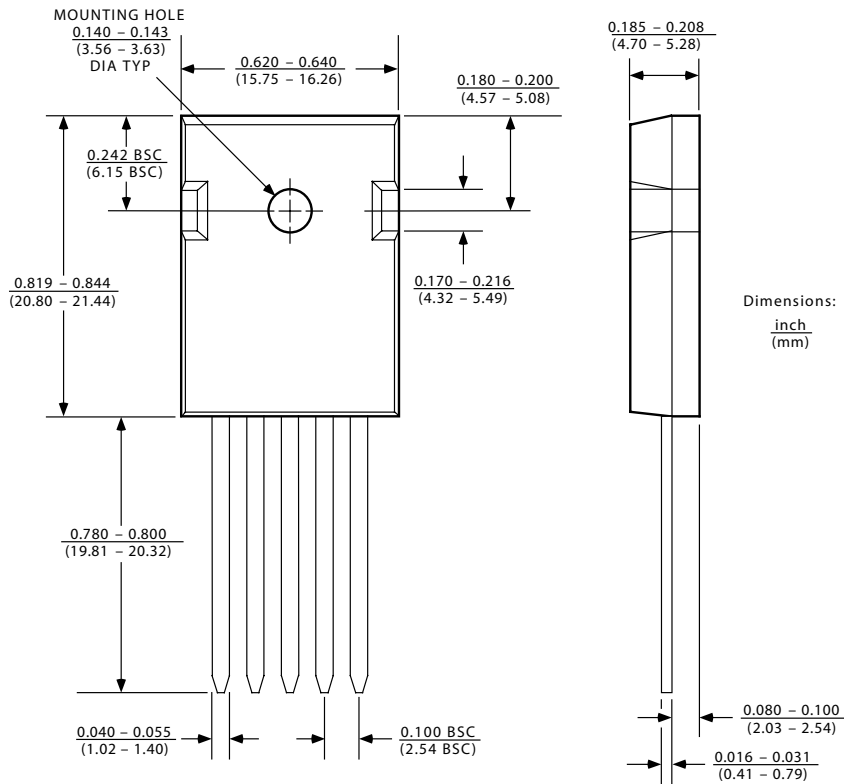

5-Lead TO-247 (W)

MICREL INC. 2180 FORTUNE DRIVE SAN JOSE, CA 95131 USA
TEL + 1 (408) 944-0800 FAX + 1 (408) 474-1000 WEB <http://www.micrel.com>

This information furnished by Micrel in this data sheet is believed to be accurate and reliable. However no responsibility is assumed by Micrel for its use.
Micrel reserves the right to change circuitry and specifications at any time without notification to the customer.

Micrel Products are not designed or authorized for use as components in life support appliances, devices or systems where malfunction of a product can reasonably be expected to result in personal injury. Life support devices or systems are devices or systems that (a) are intended for surgical implant into the body or (b) support or sustain life, and whose failure to perform can be reasonably expected to result in a significant injury to the user. A Purchaser's use or sale of Micrel Products for use in life support appliances, devices or systems is a Purchaser's own risk and Purchaser agrees to fully indemnify Micrel for any damages resulting from such use or sale.

© 2003 Micrel Incorporated