

CATALOG

Electronic relays and controls

Offer overview and technical data



- Time relays
- Measuring and monitoring relays
- Primary switch mode power supplies
- Interface relays and optocouplers

ABB has the industry's most comprehensive range of time relays measuring and monitoring relays, interface relays and power supplies – helping you to source all critical components from a single global supplier.

Increase the reliability of process equipment with control devices that provide intelligent signals and smart adjustments that help you achieve maximum system availability.

Electronic relays and controls

Table of contents

4	Overview
13	Time relays
73	Measuring and monitoring relays
267	Power supplies
401	Interface relays and optocouplers
501	Index

Interface relays and optocouplers

A proven technology used worldwide

Relays are universally applicable and are utilized in a diverse array of applications. They are a significant element in contemporary industrial processes and are used in applications where galvanic isolation, signal separation, voltage coupling and signal amplification are required.



Optocouplers are predominantly used in applications where a high switching frequency is necessary. Furthermore, optocouplers do not contain any moving parts and are therefore bounce-free, immune to vibrations and possess a long electrical life. This wide selection of relays adheres to the highest global standards and satisfies the requirements for a diverse number of applications and needs.

ABB offers a complete range of interface relays and optocouplers for increased flexibility and choice. This portfolio includes pluggable relays for easy interchangeability and optocouplers for an extended electrical life. The portfolio includes electromechanical relays and optocouplers - the electromechanical relays operate using an electromagnetic field, whereas optocouplers use light.

Billions
of relays operate and
interface between control
circuits and electrical loads

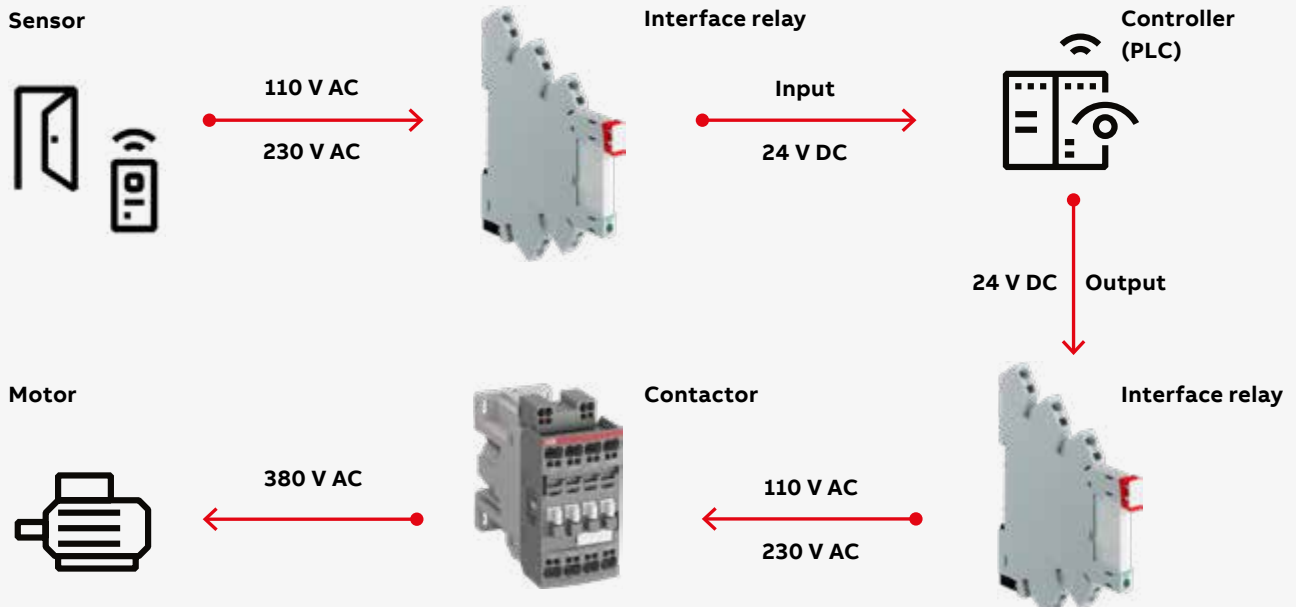

Time relays

Have the perfect timing- everywhere

Available in three different ranges to cover every application, the CT range time relays are used to provide reliable timing functions worldwide. In both industrial and building applications, the time relays of the CT range have proven their excellent functionality in daily use under the toughest conditions.

Choose ABB as the partner for all your low voltage timing control needs to leverage our wide variety of product options. From economic to high-end solutions – the range offers maximum value. Time relays are found everywhere, for example in air conditioning systems, heaters and fans in industrial and in residential buildings. On-delay, off-delay and a range of other functions cover all requirements.



Shock
and vibration resistant
CT-S relays are perfect
for use in rolling stock

- Control panels
- Pump controls
- Star-delta motor starting
- Movable equipment like cranes
- Machine tools
- Automatic doors
- Car park barriers
- Assembly machines
- HVAC
- Compressor controls
- Transportation
- Industrial refrigeration
- Packaging machines
- Baking ovens
- Water and wastewater
- Wind
- Industrial cleaning processes

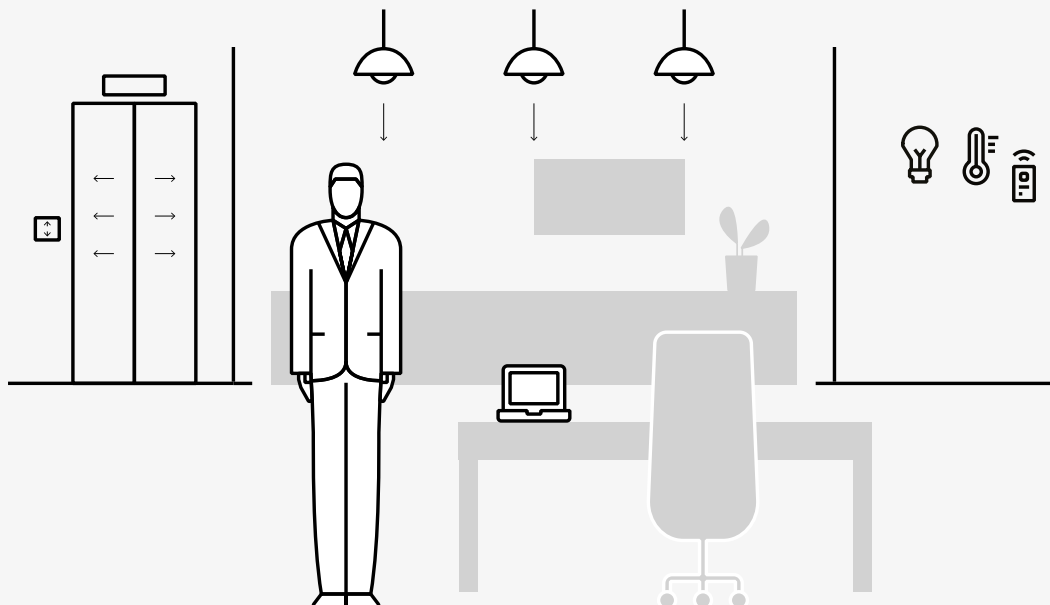

Primary switch mode power supplies

Excellent reliability in harsh environments

Available in five different ranges to cover every application requirement, ABB's CP range power supplies are used to power valuable assets worldwide.



E-mobility



Emergency lighting



LED lighting



Communication



Printing industry



Packaging industry



Food industry



Escalators



Elevators



Choose ABB as your power supply partner and leverage our wide variety of product options. From economic to high-end solutions, the CP range offers maximum value. Their excellent reliability in daily use is well proven even under the toughest of conditions.





Measuring and monitoring relays

Increase process availability and take action

The relays inform users about abnormal conditions and allow them to take necessary corrective actions before severe and costly failures can occur.



Measuring and monitoring relays monitor and detect operating conditions with regard to phase, current, voltage, frequency, temperature, liquid level or insulation faults. The relays inform users about abnormal conditions and allow them to take necessary corrective actions before severe and costly failures can occur.

ABB offers the broadest range of measuring and monitoring relays in the industry - so you can source your critical components from a global supplier. Increase the reliability of your process equipment with controllers that deliver intelligent signals and settings to ensure maximum availability. Ensure continuous operation, engineer time savings and benefit from ABB's global support for measuring and monitoring relays.





Electronic relays and controls websites

Your one-stop shop for product information

On our web site you will also find the products in this catalog together with the current life cycle status, data sheets, certificates and tools.



3D data



Life cycle
information



Coordination
tables (SOC)



E-configure



Certificates

new.abb.com/low-voltage/products/electronicrelays

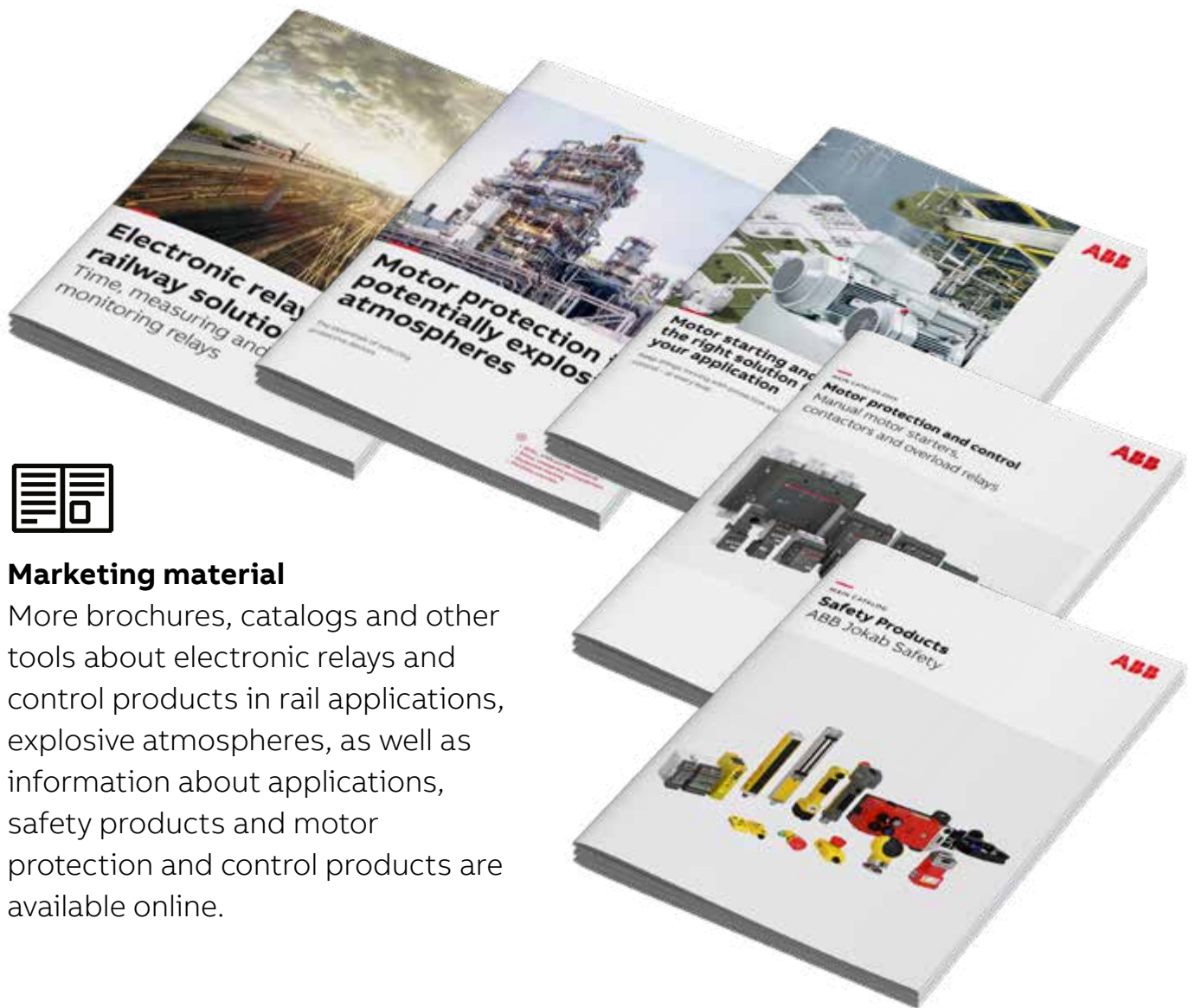

Marketing material

More brochures, catalogs and other tools about electronic relays and control products in rail applications, explosive atmospheres, as well as information about applications, safety products and motor protection and control products are available online.



Online data sheets

For detailed product information, use the order code to access the online data sheets as in the following example:

new.abb.com/products/1SVR750740R0120

Detailed information for CM-TCN-0825	
This page contains technical description, dimensions, drawings and photos of the product. You should also find information about contact points for orders in the bottom of the page.	
Data Sheet Certificates Safety Data Sheet	
CM-TCN-0825	
Technical information	View technical data
Ordering information	View ordering information
Product ID	1SVR750740R0120
Part	CM-TCN-0825
Category description	Time delay relay, monitoring relay (100/100V AC, 250V AC, 250V DC)
Long description	Time delay relay for general purpose monitoring relay with 100V AC, 250V AC or 250V DC or 250V DC supply. The relay features a built-in time delay (T ₁) and a built-in time delay (T ₂). The relay is designed for monitoring of electrical circuits and is suitable for use in industrial and commercial applications. The relay is designed for use in explosive atmospheres and is suitable for use in hazardous areas.
Category	Time delay relays (CM-TCN-0825)
Product ID	1SVR750740R0120
Part	CM-TCN-0825
Maximum rated current	100 mA
Maximum rated voltage	250 V AC
Product height / length	257 mm
Product width	257 mm
Product weight	117 kg
Technical description	Time delay relay for general purpose monitoring relay with 100V AC, 250V AC or 250V DC supply. The relay features a built-in time delay (T ₁) and a built-in time delay (T ₂). The relay is designed for monitoring of electrical circuits and is suitable for use in industrial and commercial applications. The relay is designed for use in explosive atmospheres and is suitable for use in hazardous areas.
Product ID	1SVR750740R0120
Part	CM-TCN-0825
Maximum rated current	100 mA
Maximum rated voltage	250 V AC
Product height / length	257 mm
Product width	257 mm
Product weight	117 kg
Technical description	Time delay relay for general purpose monitoring relay with 100V AC, 250V AC or 250V DC supply. The relay features a built-in time delay (T ₁) and a built-in time delay (T ₂). The relay is designed for monitoring of electrical circuits and is suitable for use in industrial and commercial applications. The relay is designed for use in explosive atmospheres and is suitable for use in hazardous areas.
Product ID	1SVR750740R0120
Part	CM-TCN-0825
Maximum rated current	100 mA
Maximum rated voltage	250 V AC
Product height / length	257 mm
Product width	257 mm
Product weight	117 kg





ABB Connect

Your digital assistant

Connect to your electrification solutions with your digital assistant, access the latest news, and create your own digital workspace; search '**ABB Connect**' on the Apple App Store, Google Play Store or Microsoft Store and download today.

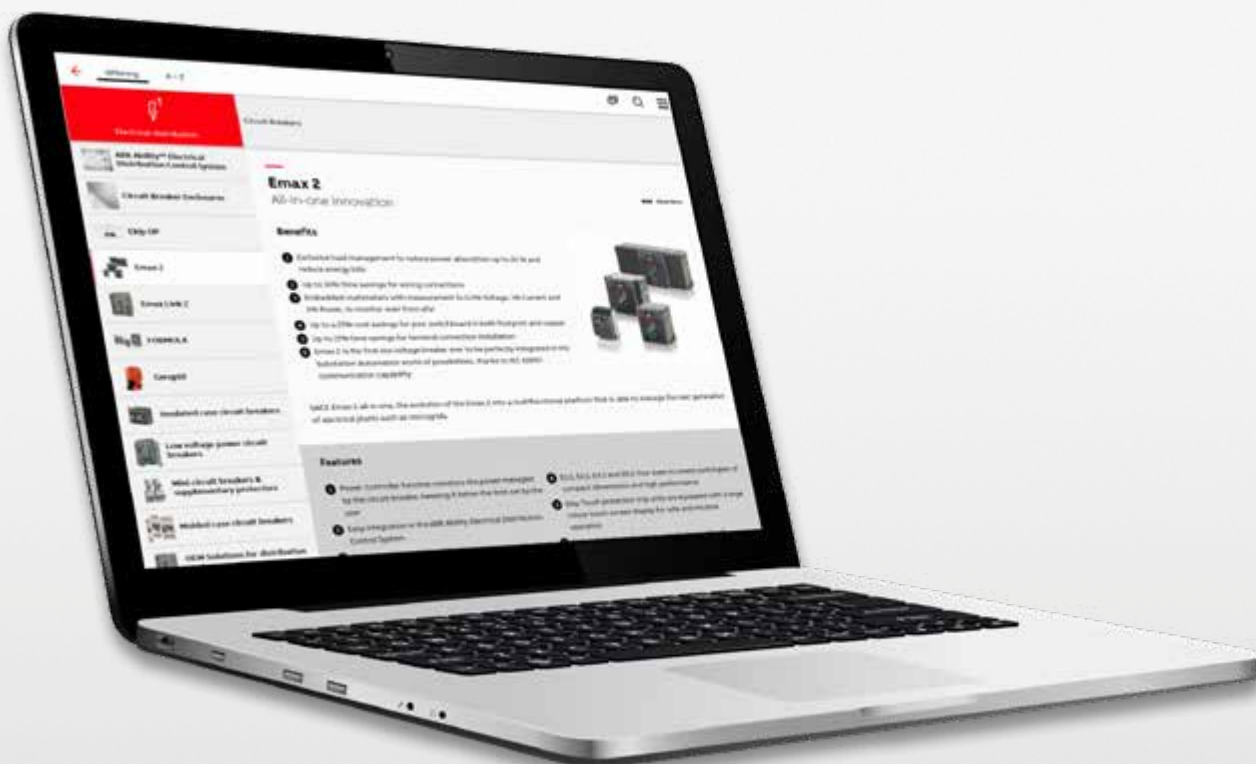

**Find the latest
product details**



**Make your phone or
tablet your workspace**



**Tap and stay
connected to all the
latest information**

new.abb.com/low-voltage/service/abb-connect



Time relays

Table of contents

15	Time relays for industrial applications
21	CT-C range
33	CT-S range
51	Time relays for building applications
54	CT-D range
65	Timing functions



Time relays for industrial applications

Table of contents

16	Offer overview
19	Applications
21	CT-C range
33	CT-S range

Time relays for industrial applications

Offer overview



CT-C: the compact range

The CT-C range combines lower cost with higher value and performance by offering essential functions in a space-saving 17.5 mm housing. The range offers a choice of 11 devices, including single and multifunctional types, with timing functions that range from 0.05 seconds to 100 hours. Equipped with a wide voltage range, the CT-C range is suitable for a huge variety of applications worldwide.

















CT-S: the high-performance range

The advanced CT-S range is ABB's universal range of electronic timers. It includes 22 single-function devices and 16 multifunction time relays, offering flexibility in operation with up to 13 functions. The devices feature seven or ten time ranges, adjustable from 0.05 seconds to 300 hours. Additionally, every device is available in two different connection technologies: familiar double-chamber cage connection terminals (screw terminals) and ABB's vibration-resistant Easy Connect technology (push-in terminals).

Time relays for industrial applications

Type selection

	multi-functional	single-functional	multi-functional	single-functional
Timing function	CT-C		CT-S	
 ON-delay	CT-MFC, CT-MKC	CT-ERC	CT-MVS, CT-MFS, CT-MBS, CT-WBS	CT-ERS
 OFF-delay	CT-MFC, CT-MKC, CT-ARC	CT-AHC	CT-MVS, CT-MFS, CT-MBS	CT-APS, CT-AHS, CT-ARS
 ON- and OFF-delay			CT-MVS, CT-MXS, CT-MFS, CT-MBS	
 Impulse-ON	CT-MFC, CT-MKC	CT-VWC	CT-MVS, CT-MFS, CT-MBS, CT-WBS	
 Impulse-OFF	CT-MFC, CT-MKC, CT-ARC		CT-MVS, CT-MFS, CT-MBS	
 Impulse-ON and OFF			CT-MXS	
 Flasher starting with ON	CT-MFC, CT-MKC	CT-EBC	CT-MFS, CT-MBS, CT-WBS	
 Flasher starting with OFF	CT-MFC, CT-MKC	CT-EBC	CT-MFS, CT-MBS, CT-WBS	
 Flasher starting with ON or OFF			CT-MVS	
 Pulse generator starting with ON or OFF		CT-TGC	CT-MXS	
 Pulse former	CT-MFC, CT-MKC		CT-MVS, CT-MFS, CT-MBS	
 Star-delta change-over		CT-SDC, CT-SAC		CT-SDS
 Star-delta change-over with impulse			CT-MVS.2x, CT-MFS, CT-MBS	
 further functions (depending on device)			CT-MVS, CT-MXS, CT-MFS, CT-MBS, CT-WBS	
Alternating without time delay		CT-PAC		

A detailed explanation of the different timing functions can be found in the chapter "Timing functions".

Synonyms

Used expression	Alternative expression(s)
1 c/o contact	SPDT
2 c/o contacts	DPDT
voltage-related	wet / non-floating
volt-free	dry / floating



Time relays for industrial applications

Applications

ABB offers a wide selection of time relays – from economic to high-end – to suit every application for businesses worldwide. ABB time relays provide simple, reliable and economical control solutions in all types of panel. They are typically used in industrial applications and OEM equipment, providing time-delayed switching to start a motor, control a load or manage a process.



Remote control of time delays with a remote potentiometer.



Cyclic switching of machinery, for example the weekly startup of a fan to prevent them sticking or the flushing of pipes to keep them clear.



Lighting control, for example the delayed switching of multiple rows of lamps in production facilities or greenhouses.



Time controlled start up or shut down of machinery equipment, for example the delayed switch off of conveyor belts or the successive shut down of a plant.



Alarm triggering in case of fault detection, for example to allow the flashing of a lamp in industrial applications or rolling stock.



Star-delta motor starting to reduce starting current with changeover delay to prevent interphase short-circuits.

Have the perfect timing everywhere with ABB's time relays:

- Control panels
- Pump controls
- Star-delta motor starting
- Movable equipment e.g. cranes
- Machine tools
- Automatic doors
- Car park barriers
- Assembly machines
- HVAC
- Compressor controls
- Transportation
- Industrial refrigeration
- Packaging machines
- Baking ovens
- Water and wastewater
- Wind
- Industrial cleaning processes



CT-C range

Table of contents

22	Benefits and advantages
23	Operating controls
24	Selection table
25	Ordering details
26	Technical data
30	Technical diagrams

CT-C range

Benefits and advantages



The CT-C range combines lower cost with higher value and performance by offering essential functions in a 17.5 mm housing, freeing up room in any control cabinet. The range includes 11 devices, offering both single and multifunctional types, with a time range from 0.05 seconds to 100 hours. Equipped with wide voltage ranges, CT-C time relays allow for use across a huge variety of applications worldwide.

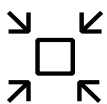

Space savings

With a width of just 17.5 mm, the CT-C range is 22% smaller than standard industrial housings for time relays. Its reduced overall footprint saves space in control cabinets. For more flexibility both 1 c/o and 2 c/o output versions are offered in the compact housing.



Cost effective solution

The CT-C range is an economical range that combines lower cost with higher value and performance. It suits basic applications where a time relay is needed, while offering improved functionality in each device.



Optimized logistics

By combining more functions into each device, the CT-C range makes it possible to reduce stock by up to 75% compared to other ranges. All devices in the CT-C range offer a wide supply voltage range as well as a wide time setting range from 0.05 seconds to 100 hours. This significantly reduces order code variance, making the range more compact with just 15 order codes covering every requirement.

CT-C range

Operating controls



Connection terminals

Wide terminal spacing makes wiring connections easier: 2 x 1.5 mm² (2 x 16 AWG) with wire end ferrules or 2 x 2.5 mm² (2 x 14 AWG) without ferrules.



Preselection of the time range









Direct reading scales

Direct setting of the time delay without any additional calculation provides accurate time delay adjustment.



Selection of the timing function

-  ON-delay
-  OFF-delay with aux. voltage
-  Impulse-ON
-  Impulse-OFF with aux. voltage
-  Flasher starting with ON
-  Flasher starting with OFF
-  Pulse former

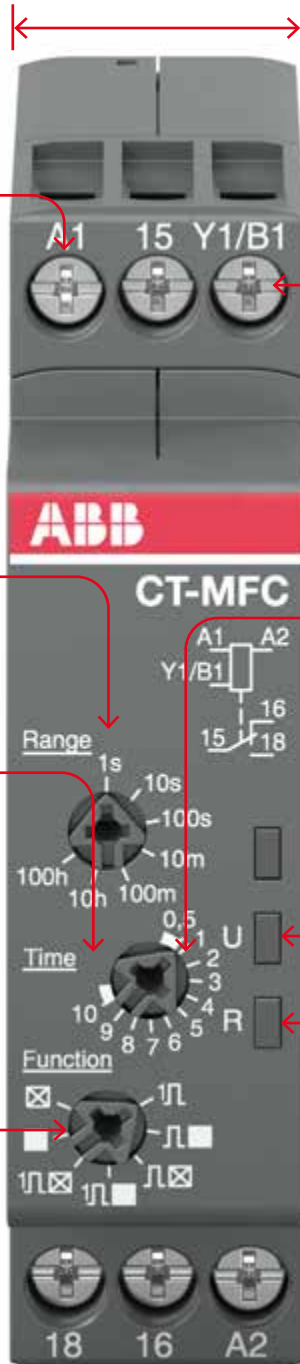

Width 17.5 mm

With a width of just 17.5mm, CT-C time relays are ideal for installations with limited space.

Control input to start timing





Fine adjustment of the time delay



LEDs for status indication

All actual operational states are displayed by front-facing LEDs, simplifying commissioning and troubleshooting.

- U - green LED:  control supply voltage applied /  timing
- R, R1, R2 - yellow LED:  output relay energized

CT-C range

Ordering details



2CDC251039V0018

CT-MFC.12



2CDC251029V0018

CT-ERC.22

- Control input with voltage-related triggering
- No triggering

Description

The CT-C range combines lower cost with higher value and performance in a slim 17.5 mm-wide housing. All relays have a wide time setting range from 0.05 seconds up to 100 hours. Combined with a wide voltage range they are the perfect choice for applications worldwide.

Ordering details

Timing function	Rated control supply voltage	Time ranges	Control input	Output	Type	Order code	Weight (1 pc) kg (lb)
Multi ¹⁾	12-240 V AC/DC	7 (0.05 s - 100 h)	■	Solid state	CT-MKC.31	1SVR508010R1300	0.060 (0.132)
Multi ¹⁾	24-240 V AC 24-48 V DC		■	1 c/o	CT-MFC.12	1SVR508020R0000	0.060 (0.132)
Multi ¹⁾	12-240 V AC/DC		■	2 c/o	CT-MFC.21	1SVR508020R1100	0.065 (0.143)
Dual ²⁾	24-48 V DC 24-240 V AC	4 (0.05 s - 10 min)	-	1 c/o	CT-ARC.12	1SVR508120R0000	0.060 (0.132)
ON-delay	24-240 V AC 24-48 V DC	7 (0.05 s - 100 h)	-	1 c/o	CT-ERC.12	1SVR508100R0000	0.060 (0.132)
			-	2 c/o	CT-ERC.22	1SVR508100R0100	0.065 (0.143)
OFF-delay			■	1 c/o	CT-AHC.12	1SVR508110R0000	0.060 (0.132)
			■	2 c/o	CT-AHC.22	1SVR508110R0100	0.065 (0.143)
Impulse-ON			-	1 c/o	CT-VWC.12	1SVR508130R0000	0.060 (0.132)
Flasher ³⁾			-		CT-EBC.12	1SVR508150R0000	0.060 (0.132)
Pulse generator		2×7 (0.05 s - 100 h)	■		CT-TGC.12 ⁴⁾	1SVR508160R0000	0.060 (0.132)
			■	2 c/o	CT-TGC.22 ⁴⁾	1SVR508160R0100	0.065 (0.143)
Star-delta change-over		4 (0.05 s - 10 min)	-	2 n/o	CT-SDC.22 ⁵⁾	1SVR508211R0100	0.065 (0.143)
			-		CT-SAC.22 ⁶⁾	1SVR508210R0100	
Alternating without time delay	24-240 V AC 24-48 V DC	-	-	2 n/o	CT-PAC.22	1SVR508180R0100	0.059 (0.130)

¹⁾ Functions: ON-delay, OFF-delay with auxiliary voltage, Impulse-ON, Impulse-OFF with auxiliary voltage, Flasher starting with ON, Flasher starting with OFF, Pulse former

²⁾ OFF-delay without aux. voltage (True OFF-delay), True Impulse-OFF

³⁾ Flasher starting with ON, Flasher starting with OFF

⁴⁾ ON and OFF times adjustable independently: 2 x 7 time ranges 0.05 s - 100 h





⁵⁾ Transition time 50 ms fixed

⁶⁾ Transition time adjustable

CT-C range

Technical data

Data at $T_a = 25\text{ °C}$ and rated values, unless otherwise indicated

		CT-C with 1 c/o contact	CT-C with 2 c/o contacts	CT-MFC.21	CT-MKC.31	CT-PAC.22
Input circuit - Supply circuit						
Rated control supply voltage U_s		24-240 V AC / 24-48 V DC		12-240 V AC/DC		24-240 V AC/ 24-48 V DC
Rated control supply voltage U_s tolerance		-15...+10 %				
Rated frequency		DC or 50/60 Hz				
Frequency range AC		47-63 Hz				
Typical power consumption		max. 3.5 VA				
Power failure buffering time		min. 20 ms				
Release voltage		> 10 % of the minimum rated control supply voltage U_s				
Minimum energizing time	CT-ARC	100 ms				
Formatting time ¹⁾	CT-ARC	5 min				
Input circuit - Control circuit						
Control input, control function	A1-Y1/B1	start timing external				-
Kind of triggering		voltage-related triggering				-
Resistance to reverse polarity		yes				-
Parallel load / polarized		yes / yes				-
Maximum cable length to the control inputs		50 m - 100 pF/m				-
Minimum control pulse length		20 ms				-
Control voltage potential		see rated control supply voltage				-
Timing circuit						
Time ranges	7 time ranges 0.05 s - 100 h	1.) 0.05-1 s 2.) 0.5-10 s 3.) 5-100 s 4.) 0.5-10 min 5.) 5-100 min 6.) 0.5-10 h 7.) 5-100 h				-
	4 time ranges 0.05 s - 10 min (CT-SDC, CT-SAC, CT-ARC)	1.) 0.05-1 s 2.) 0.5-10 s 3.) 5-100 s 4.) 0.5-10 min				-
Recovery time		< 50 ms				-
Accuracy within the rated control supply voltage tolerance		$\Delta t < 0.005\% / V$				-
Accuracy within the temperature range		$\Delta t < 0.06\% / \text{°C}$				-
Repeat accuracy (constant parameters)		$\Delta t < \pm 0.5\%$				-
Setting accuracy of time delay		$\pm 10\%$ of full-scale value				-
Star-delta transition time	CT-SDC / CT-SAC	fixed 50 ms / adjustable: 20 ms, 30 ms, 40 ms, 50 ms, 60 ms, 80 ms or 100 ms				-
Star-delta transition time tolerance	CT-SDC / CT-SAC	$\pm 3\text{ ms}$				-
Indication of operational states						
Control supply voltage / timing	U: green LED	 : control supply voltage applied  : timing				 : control supply voltage applied
Relay energized	R, R1, R2: yellow LED	 : output relay energized				
Operating elements and controls						
Adjustment of the time range		front-face rotary switch, direct reading scales				-
Fine adjustment of the time value		front-face potentiometer				-
Preselection of the timing function at multifunction devices		front-face rotary switch, direct reading scales				-
Adjustment of the transition time	CT-SAC	front-face potentiometer				-
Selection of alternating relay function ²⁾	CT-PAC	-				front-face rotary switch

¹⁾ Prior to first commissioning and after a six month stop of operation.

²⁾ Besides three marked rotary switch positions, CT-PAC has a fourth unmarked position after R2 in a clockwise direction. This position corresponds to the function R2.

CT-C range

Technical data

		CT-C with 1 c/o contact	CT-C with 2 c/o contacts	CT-MFC.21	CT-MKC.31	CT-PAC.22
Output circuit						
Kind of output	15-16/18	Relay, 1 c/o contact	-			
	15-16/18; 25-26/28	-	Relay, 2 c/o contacts		-	
	17-18	-			Solid state, 1 n/o contact	-
	17-18; 17-28	-	Relay 2 n/o (CT- SDC, CT-SAC)	-		
	13-14; 13-24	-				Relay, 2 n/o contacts
Contact material	Cd free			-	-	
Rated operational voltage U_e	250 V					
Minimum switching voltage / minimum switching current	12 V / 100 mA				5 V / 1 mA	12 V / 100 mA
Maximum switching voltage / maximum switching current	see load limit curves				250 V AC/ 1 A (resistive)	see load limit curve
Rated operational current I_e	AC-12 (resistive) at 230 V	4 A	4 A	4 A	1 A	4 A
	AC-15 (inductive) at 230 V	3 A	3 A	n/o: 3 A n/c: 0.75 A	0.2 A	3 A
	DC-12 (resistive) at 24 V	4 A	4 A	4 A	1 A	4 A
	DC-13 (inductive) at 24 V	2 A (CT-ARC: 1.5 A)	2 A	1 A	1 A	2 A
AC rating (UL 508) (except CT-MKC)	utilization category (Control Circuit Rating Code)	B 300	B 300	n/o: B 300 n/c: C 300	-	B300
	max. rated operational voltage	300 V AC	300 V AC	300 V AC	-	300 V AC
	maximum continuous thermal current at B300	5 A	5 A	n/o: 5 A	-	5 A
	maximum continuous thermal current at C300	-	-	n/c: 2.5 A	-	-
	max. making/breaking apparent power at B300	3600 VA / 360 VA	3600 VA / 360 VA	n/o: 3600/360 VA	-	3600 VA / 360 VA
	max. making/breaking apparent power at C300	-	-	n/c: 1800/180 VA	-	-
Rating (UL 60947-5-1) (CT-MKC)	utilization category	-	-	-	AC-15: 0.2 A / 230 V DC-13: 1 A / 24 V	-
	max. rated operational voltage	-	-	-	250 V	-
	max. continuous thermal curren	-	-	-	1 A	-
Mechanical lifetime	30 x 10 ⁶ switching cycles				-	30 x 10 ⁶ switching cycles
Electrical lifetime	0.1 x 10 ⁶ switching cycles				10 x 10 ⁶ switching cycles	0.1 x 10 ⁶ switching cycles
Max. fuse rating to achieve short-circuit protection	n/c contact	6 A fast-acting				
	n/o contact	10 A fast-acting		6 A fast-acting	1 A FF	10 A fast- acting

CT-C range

Technical data

		CT-C with 1 c/o contact	CT-C with 2 c/o contacts	CT-MFC.21	CT-MKC.31	CT-PAC.22
General data						
Mean time between failures (MTBF)	on request					
Duty cycle	100%					
Dimensions	see 'Dimensional drawings'					
Mounting	DIN rail (IEC/EN 60715), snap-mounting without any tool					
Mounting position	any					
Minimum distance to other units	horizontal / vertical	no (CT-ARC: 10 mm if switching current >2 A) / no				
Material of housing	UL 94 V-2					
Degree of protection	housing / terminals	IP50 / IP20				
Electrical connection						
Connecting capacity	fine-stranded with(out) wire and ferrule	2 x 0.5-1.5 mm ² (2 x 20-16 AWG) 1 x 0.5-2.5 mm ² (1 x 20-14 AWG)				
	rigid	2 x 0.5-1.5 mm ² (2 x 20-16 AWG) 1 x 0.5-4 mm ² (1 x 20-12 AWG)				
Stripping length	7 mm (0.28 in)					
Tightening torque	0.5-0.8 Nm (4.43-7.08 lb.in)					
Environmental data						
Ambient temperature range	operation / storage	-20 ... +60 °C / -40 ... +85 °C				
Climatic class	IEC/EN 60721-3-3	3k22				
Relative humidity range	25-85%					
Vibration, sinusoidal	IEC/EN 60068-2-6	20 m/s ² ; 10 cycles, 10...150...10 Hz				
Shock (half-sine)	IEC/EN 60068-2-27	150 m/s ² , 11 ms				
Isolation data						
Rated insulation voltage U _i	input circuit / output circuit	300 V				
	output circuit 1 / output circuit 2	300 V				
Rated impulse withstand voltage U _{imp}	between all isolated circuits	4 kV; 1.2/50 μs				
Power-frequency withstand voltage test (test voltage)	between all isolated circuits	2.5 kV; 50 Hz; 60 s				
Basic insulation (IEC/EN 60664-1)	input circuit / output circuit	300 V				
Protective separation (IEC/EN 60664-1)	input circuit / output circuit	250 V at pollution degree 2 / overvoltage category II				250 V at pollution degree 3 / overvoltage category III
Pollution degree (IEC/EN 60664-1)	3					
Overvoltage category (IEC/EN 60664-1)	III					
Standards / Directives						
Standards	IEC/EN 61812-1					IEC/EN 60947-5-1
Low Voltage Directive	2014/35/EU					
EMC Directive	2014/30/EU					
RoHS Directive	2011/65/EU incl. 2015/863/EU					
Electromagnetic compatibility						
Interference immunity to	IEC/EN 61000-6-2, IEC/EN 61000-6-1					
electrostatic discharge	IEC/EN 61000-4-2	level 3 (6 kV / 8 kV)				
radiated, radio-frequency, electromagnetic field	IEC/EN 61000-4-3	level 3 (10 V / m)				
electrical fast transient / burst	IEC/EN 61000-4-4	level 3 (2 kV / 5 kHz)				
surge	IEC/EN 61000-4-5	level 4 (2 kV L-L)				
conducted disturbances, induced by radio-frequency fields	IEC/EN 61000-4-6	level 3 (10 V)				
Interference emission	IEC/EN 61000-6-3, IEC/EN 61000-6-4					
high-frequency radiated	IEC/CISPR 22, EN 55022	class B				
high-frequency conducted	IEC/CISPR 22, EN 55022	class B				

CT-C range

Technical diagrams

Example of application - Star-delta changeover

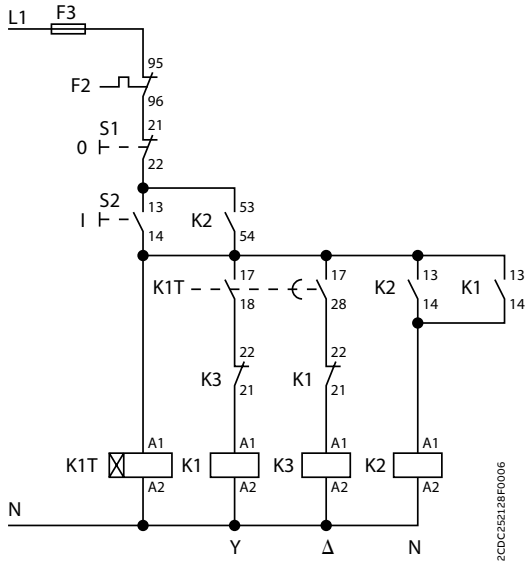

Control circuit diagram

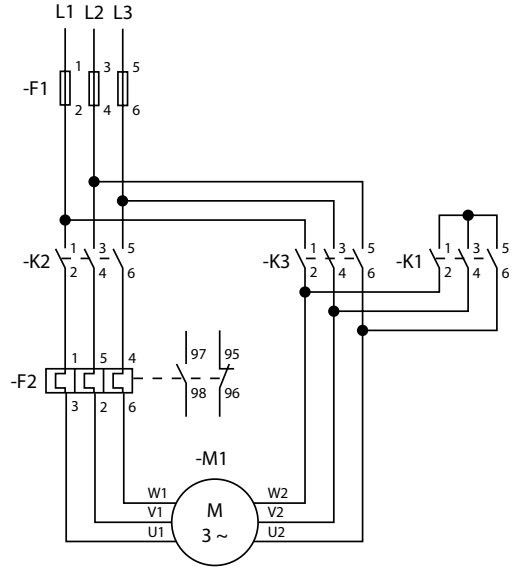

Power circuit diagram

Connection diagrams

CT-MFC.21

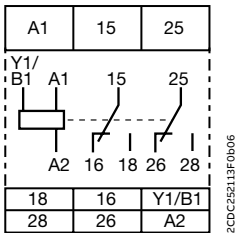

A1-A2	Supply: 12-240 V AC/DC
A1-Y1/B1	Control input
15-16/18	1st c/o contact
25-26/28	2nd c/o contact

CT-MFC.12

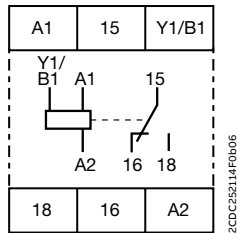

A1-A2	Supply: 24-48 V DC or 24-240 V AC
A1-Y1/B1	Control input
15-16/18	1st c/o contact

CT-ERC.22

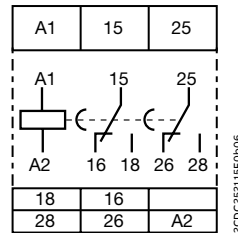

A1-A2	Supply: 24-48 V DC or 24-240 V AC
15-16/18	1st c/o contact
25-26/28	2nd c/o contact

CT-ERC.12

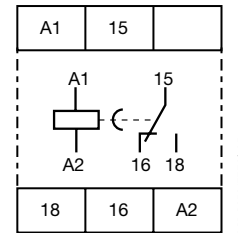

A1-A2	Supply: 24-48 V DC or 24-240 V AC
15-16/18	1st c/o contact

CT-C range

Technical diagrams

Connection diagrams

CT-AHC.22

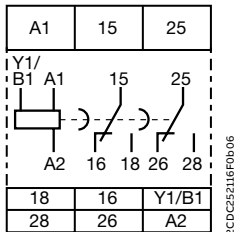

A1-A2	Supply: 24-48 V DC or 24-240 V AC
A1-Y1/B1	Control input
15-16/18	1st c/o contact
25-26/28	2nd c/o contact

CT-AHC.12

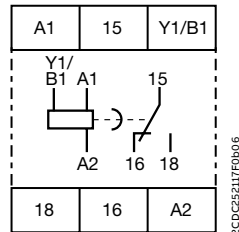

A1-A2	Supply: 24-48 V DC or 24-240 V AC
A1-Y1/B1	Control input
15-16/18	1st c/o contact

CT-VVC.12

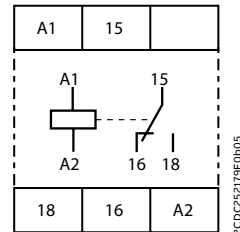

A1-A2	Supply: 24-48 V DC or 24-240 V AC
15-16/18	1st c/o contact

CT-EBC.12

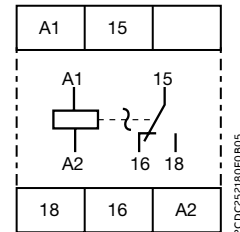

A1-A2	Supply: 24-48 V DC or 24-240 V AC
15-16/18	1st c/o contact

CT-TGC.22

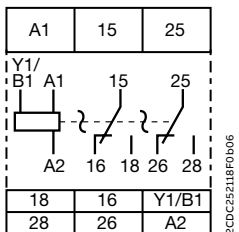

A1-A2	Supply: 24-48 V DC or 24-240 V AC
A1-Y1/B1	Control input
15-16/18	1st c/o contact
25-26/28	2nd c/o contact

CT-TGC.12

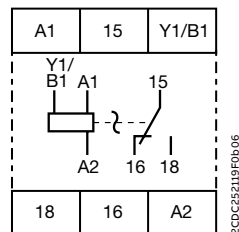

A1-A2	Supply: 24-48 V DC or 24-240 V AC
A1-Y1/B1	Control input
15-16/18	1st c/o contact

CT-SDC.22

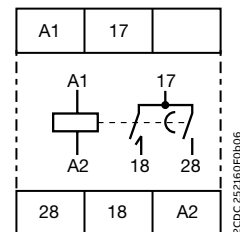

A1-A2	Supply: 24-48 V DC or 24-240 V AC
17-18	1st n/o contact (star contactor)
17-28	2nd n/o contact (delta contactor)

CT-SAC.22

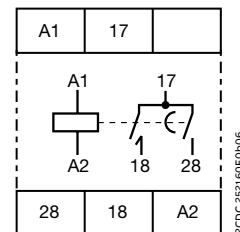

A1-A2	Supply: 24-48 V DC or 24-240 V AC
17-18	1st n/o contact (star contactor)
17-28	2nd n/o contact (delta contactor)

CT-PAC.22

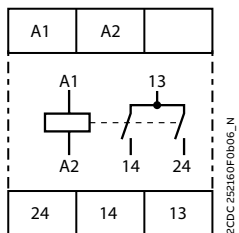

A1-A2	Supply: 24-48 V DC or 24-240 V AC
13-14	1st n/o contact (relay R1)
13-24	2nd n/o contact (relay R2)

CT-ARC.12

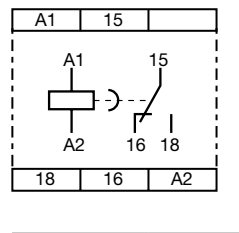

A1-A2	Supply: 12-240 V AC/DC
15-16/18	1st c/o contact

CT-MKC.31

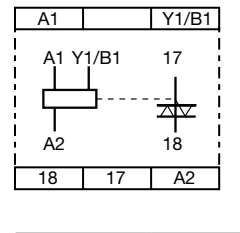

A1-A2	Supply: 12-240 V AC/DC
15-16/18	1st c/o contact

CT-C range

Technical diagrams

Load limit curves

AC load (resistive)

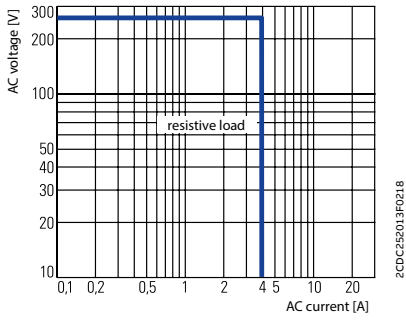

2CDC252013F0218

DC load (resistive)

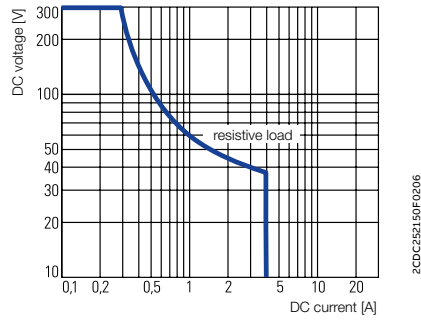

2CDC252150F0206

Derating factor F for inductive AC load

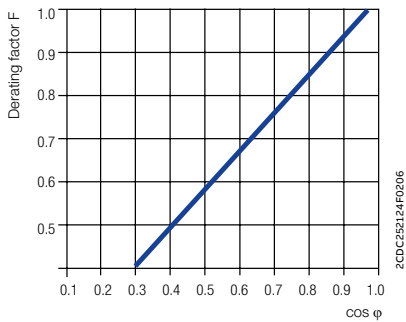

2CDC252124F0206

Contact lifetime

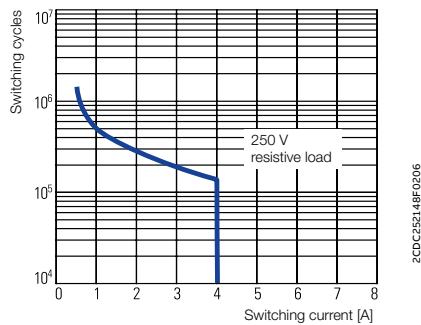

2CDC252149F0206

Wiring notes for devices with control input

A parallel load to the control input is possible

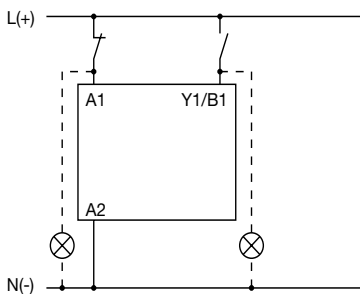

2CDC252109F0006

Dimensional drawings in mm and inches

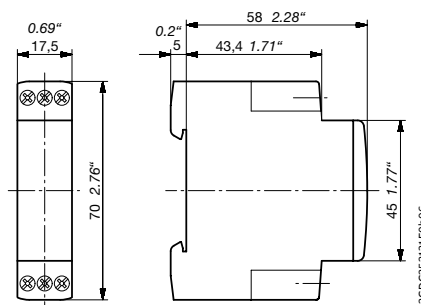

CT-C devices with 1 c/o contact or 2 n/o contacts

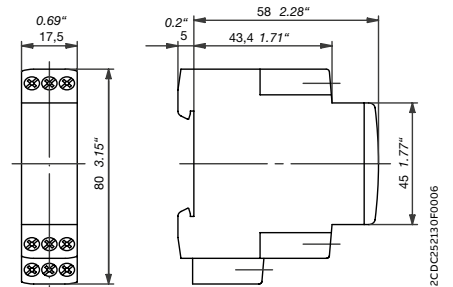

CT-C devices with 2 c/o contacts



CT-S range

Table of contents

34	Benefits and advantages
38	Selection table
39	Ordering details - multifunctional devices
40	Ordering details - singlefunctional devices
41	Ordering details - Accessories
42	Technical data
46	Technical diagrams

CT-S range

Benefits and advantages



The advanced CT-S range includes 22 single-function devices and 16 multifunction timers with up to 13 functions. The devices feature seven or ten time ranges, which are adjustable from 0.05 seconds to 300 hours. Every device is available in two different connection technologies: double-chamber cage connection terminals or ABB's vibration-resistant Push-in Technology.



Improve installation efficiency

The CT-S range allows simple tool free mounting and demounting on the DIN rail. Thanks to the easy connect and the double-chamber cage connection technology simplified wiring with or without wire end ferrules is no problem. Both allow simple and easy installation, even in case of different cable diameters.



Reliable in harsh conditions

The CT-S range's extended features make it especially suited for harsh environments. The housing material has the highest UL fire protection classification. All functions are available with Push-in terminals, making operations in environments with high vibrations possible without retightening. Additionally, the CT-S range offers devices with an extended temperature range, running operations in temperatures as low as -40 °C effortlessly. Specific types are tested according to the latest rail industry standards, making them a perfect solution for rolling stock and other rail applications



Global availability

Every device in the CT-S range is designed to provide a wide supply voltage range, making global differences irrelevant. Additionally, the CT-S range meets a broad range of standards and requirements. Together with ABB's global support and sales network, using CT-S gives customers the confidence of worldwide sourcing – no matter where they build, install or operate their equipment.

CT-S range

Operating controls

Control input
Starts and pauses timing.



Preselection of time range
Direct assignment of the pre-selected time range to the fine adjustment potentiometer scale by multicolor scales



Fine adjustment of the time delay



Selection of the timing function



Connection terminals
Screw or push-in connection available.

Remote potentiometer connection possible

2nd contact selectable as an instantaneous contact



LEDs for status indication
All actual operational states are displayed by front-face LEDs, thus simplifying commissioning and troubleshooting.

- U/T - green LED:
 - ▭ control supply voltage applied /
 - ▭ timing
- R, R1, R2 - yellow LED:
 - ▭ Output relay energized



Integrated marker label
Integrated marker labels allow the product to be marked quickly and simply. No additional marker labels are required.

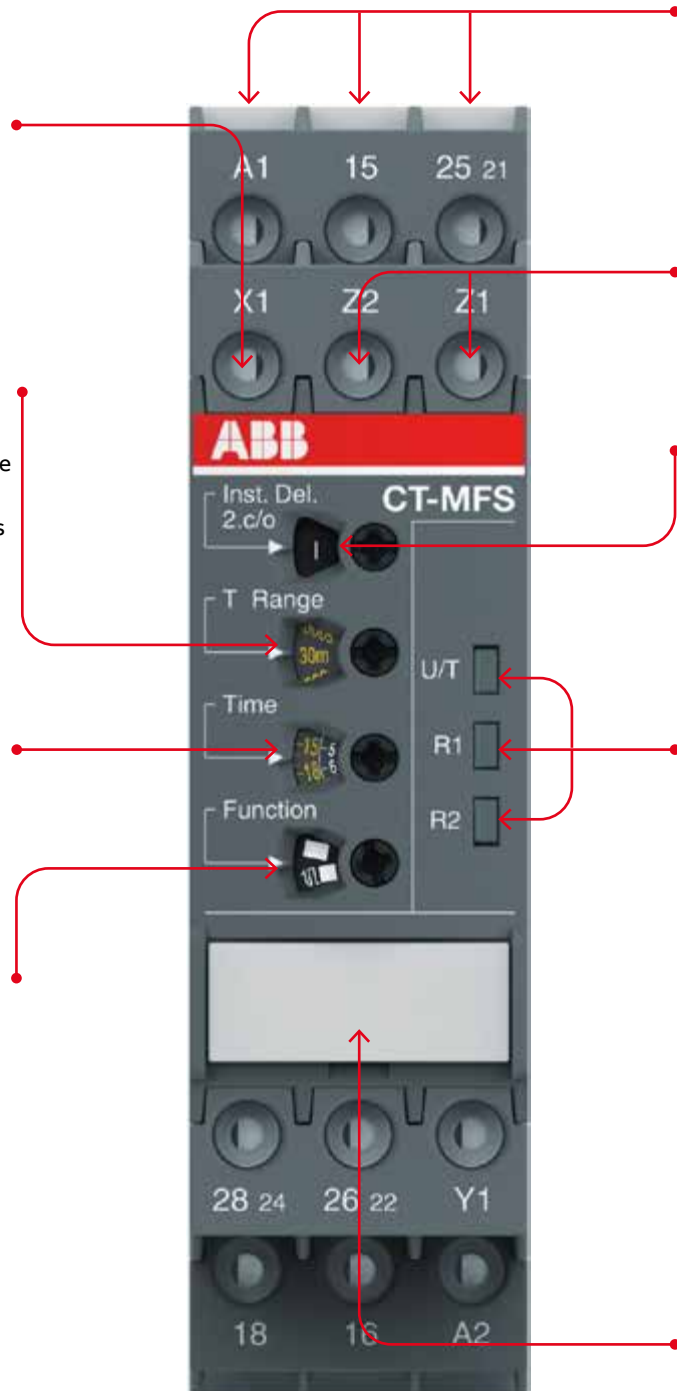

CT-S range

Benefits and advantages



2CDC253026P0011

01 Tool-free mounting of wires

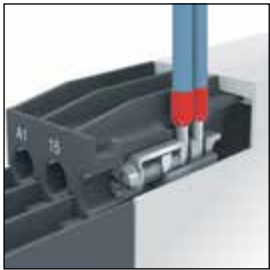

2CDC253025F0011

02 Wiring of double-chamber connection terminals with screw driver

Easy Connect Technology

Tool-free wiring and excellent vibration resistance. Easy Connect (Push-in terminals) provide connection of wires up to $2 \times 0.5 - 1.5 \text{ mm}^2$ ($2 \times 20 - 16 \text{ AWG}$), rigid or fine-strand with or without wire end ferrules. The extended type designators for products with push-in terminals are indicated by a **P** following the extended type designator e.g. CT-xxS.xx**P**.

Double-chamber cage connection terminals

According to IEC/EN 60947-1 double-chamber cage connection terminals provide connection of wires up to $2 \times 0.5 - 2.5 \text{ mm}^2$ ($2 \times 20 - 14 \text{ AWG}$) rigid or fine-strand, with or without wire end ferrules. Thanks to the technology, using different cable diameters in one terminal is easy and simple to install. Potential distribution does not require additional terminals. The extended type designators for products with double-chamber cage connection terminals (screw terminals) are indicated by an **S** following the extended type designator, e.g. CT-xxS.xx**S**.



CT-S range

Made for extreme conditions

Selected products of the CT-S range comply to the latest rail standards like EN50155. Designed for harsh environments, not only are standard screw type terminals offered – push-in terminals with excellent vibration resistance are also available. Perfect for use in rolling stock.



Conductor car

- In the event of the press switch not switching off the auxiliary release pumps of the braking system, a delayed switch off is triggered by the time relays
- While switching between hold-on and start-up coil on the main switch, a time relay can prolong the pulse
- The reliable and safe functionality of the compressor is essential for trains

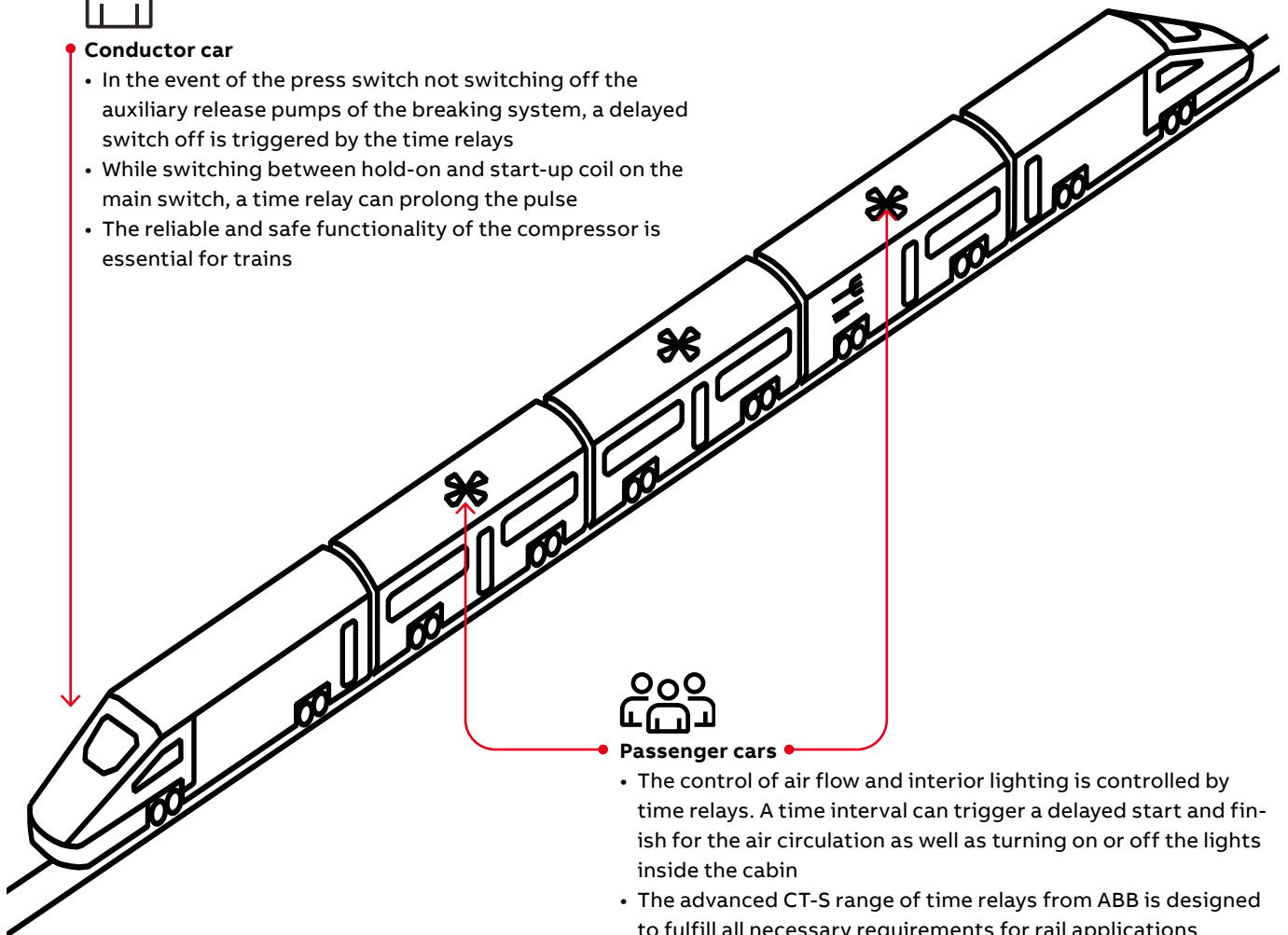

Passenger cars

- The control of air flow and interior lighting is controlled by time relays. A time interval can trigger a delayed start and finish for the air circulation as well as turning on or off the lights inside the cabin
- The advanced CT-S range of time relays from ABB is designed to fulfill all necessary requirements for rail applications



Electronic relays for railway solutions brochure

For more information about time relays in rolling stock applications visit:

new.abb.com/low-voltage/products/electronicrelays

or scan the QR code



CT-S range

Ordering details - multifunctional devices



2CDC251.024 V0001

CT-MVS.21P



2CDC251.023 V0001

CT-MBS.22P

- Control input with voltage-related triggering
- Control input with volt-free triggering
- /□ Two control inputs with volt-free triggering
- No triggering

Description

The high-performance CT-S range is ideally suited for universal use and is available with two different connection technologies:

- Double-chamber cage connection terminals (Screw terminals)
- Easy Connect Technology (Push-in terminals)

Ordering details

Timing function ⁵⁾	Rated control supply voltage	Time ranges	Control input	Output	Type	Order code	Weight (1 pc) kg (lb)
Multi	24- 240 V AC/DC	10 (0.05 s - 300 h)	■	2 c/o	CT-MVS.21S ^{1) 2) 3)}	1SVR730020R0200	0.148 (0.326)
					CT-MVS.21P ^{1) 2) 3)}	1SVR740020R0200	0.136 (0.30)
	24-48 V DC, 24-240 V AC				CT-MVS.22S	1SVR730020R3300	0.142 (0.313)
					CT-MVS.22P	1SVR740020R3300	0.131 (0.289)
	380-440 V AC				CT-MVS.23S	1SVR730021R2300	0.144 (0.317)
					CT-MVS.23P	1SVR740021R2300	0.133 (0.293)
Multi	24-48 V DC, 24-240 V AC	10 (0.05 s - 300 h)	■	1 c/o	CT-MVS.12S	1SVR730020R3100	0.107 (0.236)
					CT-MVS.12P	1SVR740020R3100	0.102 (0.225)
Multi	24-48 V DC, 24-240 V AC	2×10 (0.05 s - 300 h)	■	2 c/o	CT-MXS.22S ⁴⁾	1SVR730030R3300	0.142 (0.313)
					CT-MXS.22P ⁴⁾	1SVR740030R3300	0.131 (0.289)
Multi	24- 240 V AC/DC	10 (0.05 s - 300 h)	□ / □	2 c/o	CT-MFS.21S ^{1) 2) 3)}	1SVR730010R0200	0.145 (0.32)
					CT-MFS.21P ^{1) 2) 3)}	1SVR740010R0200	0.133 (0.293)
	24-48 V DC, 24-240 V AC				CT-MBS.22S ^{2) 3)}	1SVR730010R3200	0.14 (0.309)
CT-MBS.22P ^{2) 3)}		1SVR740010R3200	0.129 (0.284)				
Multi	24-48 V DC, 24-240 V AC	10 (0.05 s - 300 h)	-	2 c/o	CT-WBS.22S	1SVR730040R3300	0.123 (0.271)
					CT-WBS.22P	1SVR740040R3300	0.115 (0.254)

¹⁾ Extended temperature range -40 °C

²⁾ Remote potentiometer connection

³⁾ 2nd c/o contact selectable as instantaneous contact

⁴⁾ 2 remote potentiometer connections

⁵⁾ See selection table on previous page

S: Screw connection

P: Push-in / easy connect

CT-S range

Ordering details - singlefunctional devices



CT-ERS.21P

2CDC 251 030 V0011



CT-AHS.22P

2CDC 251 033 V0011



CT-SDS.23P

2CDC 251 040 V0011

- Control input with voltage-related triggering
- Control input with volt-free triggering
- /□ Two control inputs with volt-free triggering
- No triggering

Ordering details

Timing function	Rated control supply voltage	Time ranges	Control input	Output	Type	Order code	Weight (1 pc) kg (lb)	
ON-delay	24-240 V AC/ DC	10 (0.05 s - 300 h)	-	2 c/o	CT-ERS.21S ¹⁾	1SVR730100R0300	0.13 (0.287)	
					CT-ERS.21P ¹⁾	1SVR740100R0300	0.121 (0.267)	
	24-48 V DC, 24-240 V AC			CT-ERS.22S	1SVR730100R3300	0.121 (0.267)		
				CT-ERS.22P	1SVR740100R3300	0.113 (0.249)		
	24-48 V DC, 24-240 V AC		-	1 c/o	CT-ERS.12S	1SVR730100R3100	0.106 (0.234)	
			-	1 c/o	CT-ERS.12P	1SVR740100R3100	0.101 (0.222)	
OFF-delay	24-240 V AC/ DC	10 (0.05 s - 300 h)	■	2 c/o	CT-APS.21S ¹⁾	1SVR730180R0300	0.146 (0.322)	
					CT-APS.21P ¹⁾	1SVR740180R0300	0.125 (0.276)	
				24-48 V DC, 24-240 V AC	CT-APS.22S	1SVR730180R3300	0.138 (0.304)	
					CT-APS.22P	1SVR740180R3300	0.127 (0.28)	
	24-48 V DC, 24-240 V AC		■	1 c/o	CT-APS.12S	1SVR730180R3100	0.109 (0.24)	
					CT-APS.12P	1SVR740180R3100	0.103 (0.227)	
	24-48 V DC, 24-240 V AC		□	2 c/o	CT-AHS.22S	1SVR730110R3300	0.136 (0.30)	
					CT-AHS.22P	1SVR740110R3300	0.125 (0.276)	
OFF-delay ²⁾		24-240 V AC/DC		-	1 c/o	CT-ARS.11S	1SVR730120R3100	0.106 (0.234)
						CT-ARS.11P	1SVR740120R3100	0.10 (0.22)
Star-delta change- over ³⁾	24-48 V DC, 24-240 V AC	7 (0.05 s - 10 min)	-	2 c/o	CT-ARS.21S	1SVR730120R3300	0.124 (0.273)	
					CT-ARS.21P	1SVR740120R3300	0.115 (0.254)	
	380-440 V AC		CT-SDS.22S	1SVR730210R3300	0.114 (0.251)			
			CT-SDS.22P	1SVR740210R3300	0.108 (0.238)			
380-440 V AC	CT-SDS.23S	1SVR730211R2300	0.118 (0.26)					
	CT-SDS.23P	1SVR740211R2300	0.112 (0.247)					

¹⁾ Extended temperature range -40 °C

²⁾ Without auxiliary voltage

³⁾ 50 ms transition time

S: Screw connection

P: Push-in / easy connect

CT-S range

Ordering details - Accessories



MT-x50B

1SFC 151 139 V0001

The CT-S range offers the possibility of using accessories such as a remote potentiometer to adjust the time delay or a sealable, transparent cover to protect against unauthorized changes of time and threshold values.

Remote potentiometer

50 k Ω \pm 20 % - 0.2 Ω , degree of protection IP66

Material	Diameter in mm	Type	Order code	Pack.- unit pieces	Weight 1 piece g / oz
Plastic, black	22.5	MT-150B	1SFA611410R1506	1	0.040
Plastic, chrome	22.5	MT-250B	1SFA611410R2506	1	0.040
Metal, chrome	22.5	MT-350B	1SFA611410R3506	1	0.048



30 mm adapters

2CDC252 042 F0009

30 mm adapter for attaching the potentiometer 22 mm in 30 mm mounting hole

Material	Type	Order code	Pack.- unit pieces	Weight 1 piece g / oz
Plastic, black	KA1-8029	1SFA616920R8029	1	
Metal, chrome	KA1-8030	1SFA616920R8030	1	

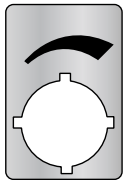

Marker label 29.6 x 44.5 mm

2CDC 252 043 F0209

Marker label

Caption	Type	Order code	Pack.- unit pieces	Weight 1 piece g / oz
Symbol (see illustration)	SK 615 562-87	GJD6155620R0087	1	0.002
Scale 0 - 10	SK 615 562-88	GJD6155620R0088	1	0.002
Scale 0 - 30	MA16-1060	1SFA611940R1060	1	0.002

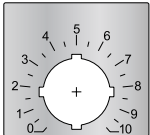
Marker label with scale 0-10
48.5 x 44.5 mm

2CDC 252 044 F0209

Accessories for CT-S

Description	Type	Order code	Pack.- unit pieces	Weight 1 piece g / oz
Adapter for screw mounting	ADP.01	1SVR430029R0100	1	0.018 (0.040)
Sealable transparent cover	COV.11	1SVR730005R0100	1	0.004 (0.009)
Marker label for devices w/o DIP switches	MAR.01	1SVR366017R0100	10	0.001 (0.002)
Marker label for devices with DIP switches	MAR.12	1SVR730006R0000	10	0.001 (0.002)

Sealable transparent cover
for CT-S in new housing

2CDC 255 006 S0011

CT-S range

Technical data





Data at $T_a = 25\text{ °C}$ and rated values, unless otherwise indicated

		CT-S
Input circuit - Supply circuit		
Rated control supply voltage U_s	CT-xxx.x1	24-240 V AC/DC
	CT-xxx.x2	24-48 V DC, 24-240 V AC
	CT-xxx.x3	380-440 V AC
Rated control supply voltage U_s tolerance		-15...+10 %
Rated frequency		DC or 50/60 Hz
Frequency range AC		47-63 Hz
Typical power consumption		max. 16 VA
Power failure buffering time	24 V DC	min. 15 ms
	230/400 V AC	min. 20 ms
Release voltage		> 10 % of the minimum rated control supply voltage U_s
Minimum energizing time		100 ms (CT-ARS)
Formatting time ¹⁾		5 min (CT-ARS)
Input circuit - Control circuit		
Kind of triggering	CT-MVS, CT-MXS, CT-APS	voltage-related triggering
Control input, Control function	A1-Y1/B1	start timing external
Parallel load / polarized		yes / no
Maximum cable length to the control input		50 m - 100 pF/m
Minimum control pulse length		20 ms
Control voltage potential		see rated control supply voltage
Current consumption of the control input	24 V DC	1.2 mA
	230 V AC	8 mA
	400 V AC	6 mA
Kind of triggering	CT-MFS, CT-MBS, CT-AHS	volt-free triggering
Control input, Control function	Y1-Z2	start timing external
	X1-Z2	pause timing / accumulative functions (CT-MFS)
Maximum switching current in the control circuit		1 mA
Maximum cable length to the control input		50 m - 100 pF/m
Minimum control pulse length		20 ms
No-load voltage at the control inputs		10-40 V DC
Remote potentiometer		
Remote potentiometer connections, resistance value	Z1-Z2	50 k Ω (CT-MFS, CT-MBS, CT-MVS.21, CT-MXS)
	Z3-Z2	50 k Ω (CT-MXS)
Maximum cable length to remote potentiometer		2 x 25 m, shielded with 100 pF/m
Shield connection		Z2
Timing circuit		
Time ranges	10 time ranges 0.05 s - 300 h	1.) 0.05-1 s 2.) 0.15-3 s 3.) 0.5-10 s 4.) 1.5-30 s 5.) 5-100 s 6.) 15-300 s 7.) 1.5-30 min 8.) 15-300 min 9.) 1.5-30 h 10.) 15-300 h
	7 time ranges 0.05 s - 10 min (CT-SDS, CT-ARS)	1.) 0.05-1 s 2.) 0.15-3 s 3.) 0.5-10 s 4.) 1.5-30 s 5.) 5-100 s 6.) 15-300 s 7.) 0.5-10 min
Recovery time	24-240 V AC/DC	< 50 ms
	24-48 V DC, 24-240 V AC	< 80 ms
	380-440 V AC	< 60 ms
Accuracy within the rated control supply voltage tolerance		$\Delta t < 0.004\%$ / V
Accuracy within the temperature range		$\Delta t < 0.03\%$ / °C
Repeat accuracy (constant parameters)		< $\pm 0.2\%$
Setting accuracy of time delay		$\pm 6\%$ of full-scale value
Star-delta transition time		fixed 50 ms (CT-SDS, CT-MBS, CT-MFS, CT-MVS.2x)
Star-delta transition time tolerance		± 2 ms

¹⁾ Prior to first commissioning and after a six-month stop in operation

CT-S range

Technical data

Indication of operational states			
Control supply voltage / timing	U/T: green LED	 : control supply voltage applied /  : timing	
Control supply voltage	U: green LED	 : control supply voltage applied	
Relay state	R, R1, R2: yellow LED	 : output relay energized	
Output circuit			
Kind of output	15-16/18	relay, 1 c/o contact	
	15-16/18; 25-26/28	relay, 2 c/o contacts	
	15-16/18; 25(21)-26(22)/28(24)	relay, 2 c/o contacts, 2nd c/o contact selectable as inst. contact	
	17-18; 17-28	relay, 2 n/o contacts (CT-SDS)	
Contact material		Cd-free, on request	
Rated operational voltage U _e	IEC/EN 60947-1	250 V	
Minimum switching voltage / minimum switching current		12 V / 100 mA	
Maximum switching voltage / maximum switching current		see load limit curves	
Rated operational current I _e	AC-12 (resistive) at 230 V	4 A	
	AC-15 (inductive) at 230 V	3 A	
	DC-12 (resistive) at 24 V	4 A	
	DC-13 (inductive) at 24 V	2 A (CT-ARS; 1.5 A)	
AC rating (UL 508)	utilization category (Control Circuit Rating Code)	B 300	
	max. rated operational voltage	300 V AC	
	maximum continuous thermal current at B300	5 A	
	max. making/breaking apparent power at B300	3600 VA / 360 VA	
Mechanical lifetime		30 x 10 ⁶ switching cycles	
Electrical lifetime	at AC-12, 230 V, 4 A	0.1 x 10 ⁶ switching cycles	
Frequency of operation	with/without load	360/72000 h ⁻¹ CT-ARS: 1200/18000 h ⁻¹	
Max. fuse rating to achieve short-circuit protection	n/c contact	6 A fast-acting	
	n/o contact	10 A fast-acting	
General data			
MTBF		on request	
Duty cycle		100%	
Dimensions		see 'Dimensional drawings'	
Mounting		DIN rail (IEC/EN 60715), snap-on mounting without any tool	
Mounting position		any	
Minimum distance to other units	vertical / horizontal	not necessary / not necessary	
Material of housing		UL 94 V-0	
Degree of protection	housing / terminals	IP50 / IP20	
Electrical connection			
Connecting capacity	fine-strand with(out) wire end ferrule	Screw connection technology	Easy Connect Technology (Push-in)
		1 x 0.5-2.5 mm ² (1 x 18-14 AWG) 2 x 0.5-1.5 mm ² (2 x 18-16 AWG)	2 x 0.5-1.5 mm ² (2 x 18-16 AWG)
	rigid	1 x 0.5-4 mm ² (1 x 20-12 AWG) 2 x 0.5-2.5 mm ² (2 x 20-14 AWG)	2 x 0.5-1.5 mm ² (2 x 20-16 AWG)
Stripping length		8 mm (0.32 in)	
Tightening torque		0.6-0.8 Nm (7.08 lb.in)	-

CT-S range

Technical data

Environmental data		
Ambient temperature ranges	operation / storage	-25...+60 °C / -40...+85 °C, -40...+60 °C / -40...+85 °C for CT-MVS.21, CT-MFS.21, CT-ERS.21, CT-APS.21
Relative humidity range		25 % to 85 %
Vibration, sinusoidal (IEC/EN 60068-2-6)	functioning	40 m/s ² , 10-58/60-150 Hz
	resistance	60 m/s ² , 10-58/60-150 Hz, 20 cycles
Vibration, seismic (IEC/EN 60068-3-3)	functioning	20 m/s ²
Shock, half-sine (IEC/EN 60068-2-27)	functioning	150 m/s ² , 11 ms, 3 shocks/direction
	resistance	300 m/s ² , 11 ms, 3 shocks/direction
Isolation data		CT-S with 1 c/o
Rated insulation voltage U _i	input circuit / output circuit	500 V
	output circuit 1 / output circuit 2	not available
Rated impulse withstand voltage U _{imp}	between all isolated circuits	4 kV; 1.2/50 μs except devices CT-xxx.23: input / output: 6 kV; 1.2/50 μs output 1 / output 2: 4 kV; 1.2/50 μs
	between all isolated circuits	2.0 kV; 50 Hz; 60 s
Power-frequency withstand voltage (test voltage)	between all isolated circuits	2.0 kV; 50 Hz; 60 s
Basic insulation (IEC/EN 60664-1)	input circuit / output circuit	500 V
Protective separation (IEC/EN 60664-1)	input circuit / output circuit	250 V
Pollution degree (IEC/EN 60664-1)		3
Overvoltage category (IEC/EN 60664-1)		III
Standards / Directives		
Standards		IEC/EN 61812-1
Low Voltage Directive		2014/35/EU
EMC Directive		2014/30/EU
RoHS Directive		2011/65/EU
Electromagnetic compatibility		
Interference immunity to		IEC/EN 61000-6-2, IEC/EN 61000-6-1
electrostatic discharge	IEC/EN 61000-4-2	Level 3, 6 kV / 8 kV
radiated, radio-frequency electromagnetic field	IEC/EN 61000-4-3	Level 3, 10 V/m (1 GHz) 3 V/m (2 GHz) 1 V/m (2.7 GHz)
electrical fast transient / burst	IEC/EN 61000-4-4	Level 3, 2 kV / 5 kHz
surge	IEC/EN 61000-4-5	Level 4, 2 kV A1-A2
conducted disturbances, induced by radio-frequency fields	IEC/EN 61000-4-6	Level 3, 10 V
harmonics and interharmonics	IEC/EN 61000-4-13	Class 3
Interference emission		IEC/EN 61000-6-3, IEC/EN 61000-6-4
high-frequency radiated	IEC/CISPR 22, EN 55022	Class B
high-frequency conducted	IEC/CISPR 22, EN 55022	Class B

CT-S range

Technical diagrams

DIP switch configuration CT-MXS.22x

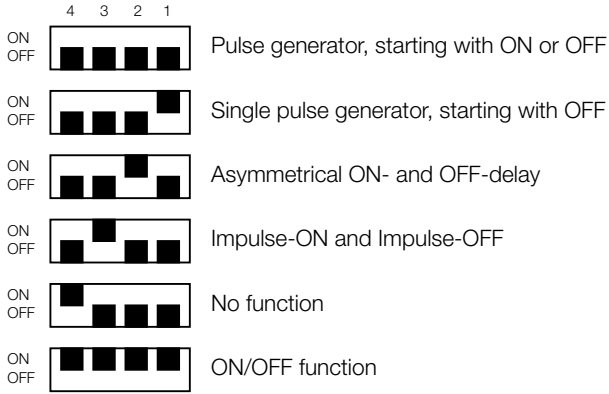

Default setting: all DIP switches in position OFF

Example of application - Star-delta changeover

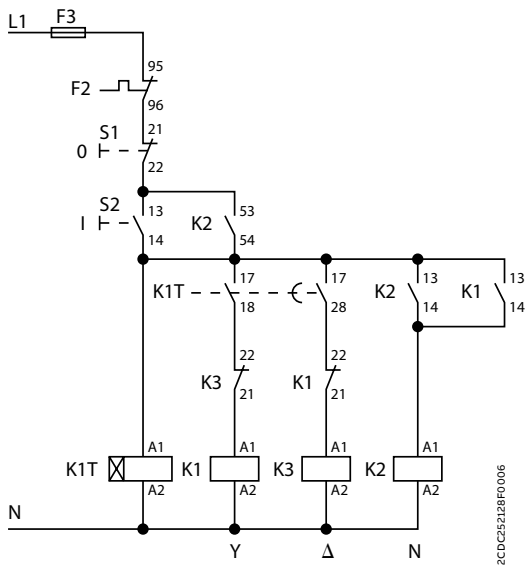

Control circuit diagram

2CDC25228F0006

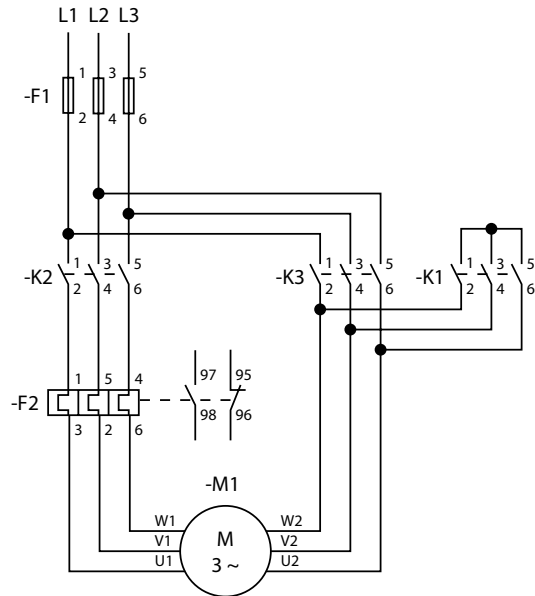

Power circuit diagram

2CDC253009F0012

CT-S range

Technical diagrams

Connection diagrams

CT-MVS.21

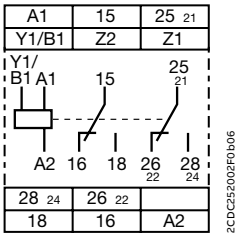

A1-A2 Supply: 24-240 V AC/DC

A1-Y1/B1 Control input

15-16/18 1st c/o contact

25-26/28 2nd c/o contact

21-22/24 2nd c/o contact as instantaneous contact

Z1-Z2 Remote potentiometer connection

CT-MVS.22

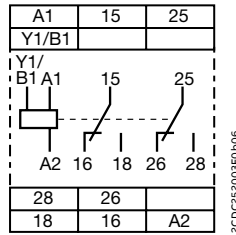

A1-A2 Supply: 224-48 V DC or 24-240 V AC

A1-Y1/B1 Control input

15-16/18 1st c/o contact

25-26/28 2nd c/o contact

CT-MVS.23

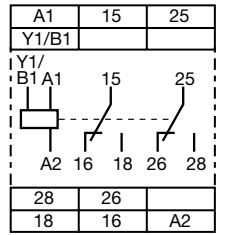

A1-A2 Supply: 380-440V AC

A1-Y1/B1 Control input

15-16/18 1st c/o contact

25-26/28 2nd c/o contact

CT-MVS.12

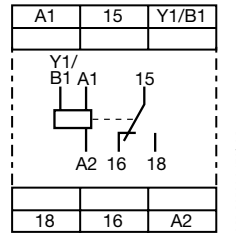

A1-A2 Supply: 24-48 V DC or 24-240 V AC

A1-Y1/B1 Control input

15-16/18 1st c/o contact

CT-MXS.22

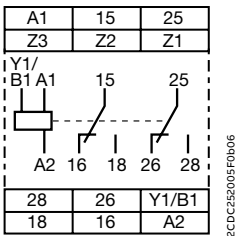

A1-A2 Supply: 24-48 V DC or 24-240 V AC

A1-Y1/B1 Control input

15-16/18 1st c/o contact

25-26/28 2nd c/o contact

Z1-Z2 Remote potentiometer connection

Z3-Z2 Remote potentiometer connection

CT-MFS.21

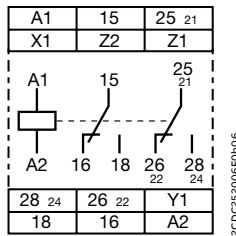

A1-A2 Supply: 24-240 V AC/DC

15-16/18 1st c/o contact

25-26/28 2nd c/o contact

21-22/24 2nd c/o contact as instantaneous contact

Y1-Z2 Control input

X1-Z2 Control input

Z1-Z2 Remote potentiometer connection

CT-MBS.22

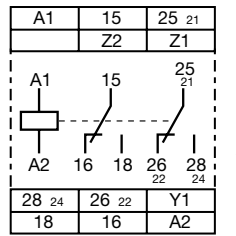

A1-A2 Supply: 24-48 V DC or 24-240 V AC

15-16/18 1st c/o contact

25-26/28 2nd c/o contact

21-22/24 2nd c/o contact as instantaneous contact

Y1-Z2 Control input

Z1-Z2 Remote potentiometer connection

CT-WBS.22

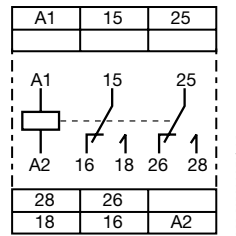

A1-A2 Supply: 24-48 V DC or 24-240 V AC

15-16/18 1st c/o contact

25-26/28 2nd c/o contact

CT-S range

Technical diagrams

Connection diagrams

☒ CT-ERS.21

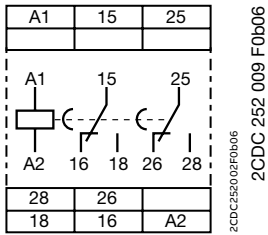

A1-A2 Supply: 24-240 V AC/DC

15-16/18 1st c/o contact

25-26/28 2nd c/o contact

☒ CT-ERS.22

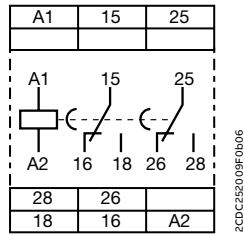

A1-A2 Supply: 24-48 V DC or 24-240 V AC

15-16/18 1st c/o contact

25-26/28 2nd c/o contact

☒ CT-ERS.12

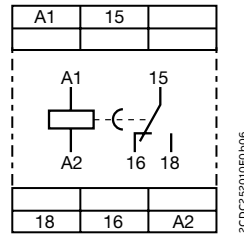

A1-A2 Supply: 24-48 V DC or 24-240 V AC

15-16/18 1st c/o contact

■ CT-APS.21

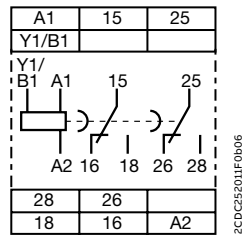

A1-A2 Supply: 24-240 V AC/DC

A1-Y1/B1 Control input

15-16/18 1st c/o contact

25-26/28 2nd c/o contact

■ CT-APS.22

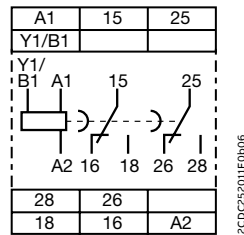

A1-A2 Supply: 24-48 V DC or 24-240 V AC

A1-Y1/B1 Control input

15-16/18 1st c/o contact

25-26/28 2nd c/o contact

■ CT-APS.12

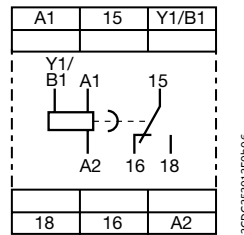

A1-A2 Supply: 24-48 V DC or 24-240 V AC

A1-Y1/B1 Control input

15-16/18 1st c/o contact

■ CT-AHS.22

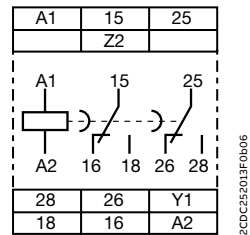

A1-A2 Supply: 24-48 V DC or 24-240 V AC

Y1-Z2 Control input

15-16/18 1st c/o contact

25-26/28 2nd c/o contact

■ CT-ARS.11

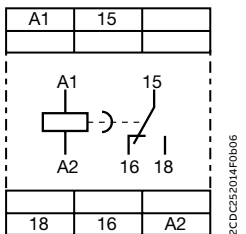

A1-A2 Supply: 24-240 V AC/DC

15-16/18 1st c/o contact

■ CT-ARS.21

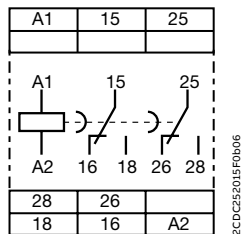

A1-A2 Supply: 24-240 V AC/DC

15-16/18 1st c/o contact

25-26/28 2nd c/o contact

△ CT-SDS.22

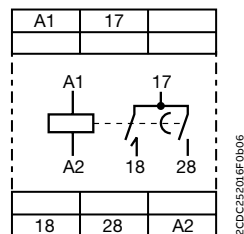

A1-A2 Supply: 24-48 V DC or 24-240 V AC

17-18 1st n/o contact

17-28 2nd n/o contact

△ CT-SDS.23

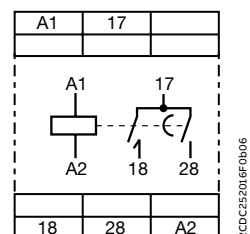

A1-A2 Supply: 380-440 V AC

17-18 1st n/o contact

17-28 2nd n/o contact

CT-S range

Technical diagrams

Load limit curves

AC load (resistive)

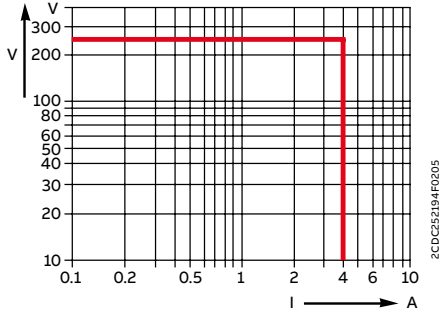

2CDC25219AF0205

DC load (resistive)

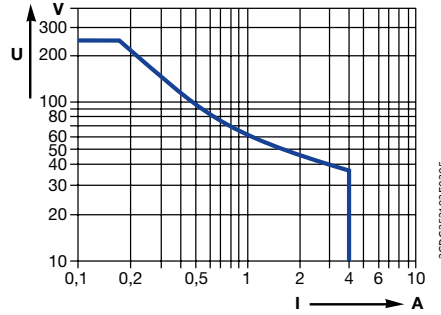

2CDC25219AF0205

Derating factor F for inductive AC load

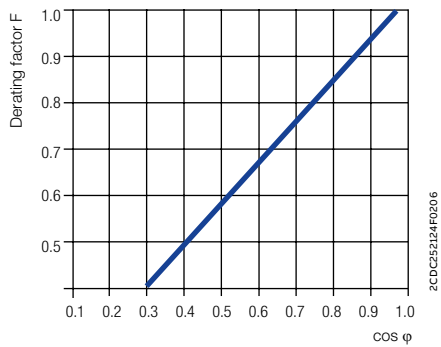

2CDC252124F0206

Contact lifetime

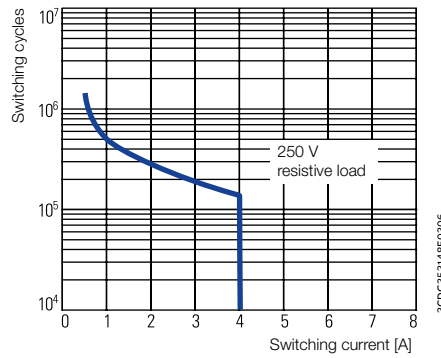

2CDC252148F0206

Wiring notes

Control inputs (volt-free triggering)

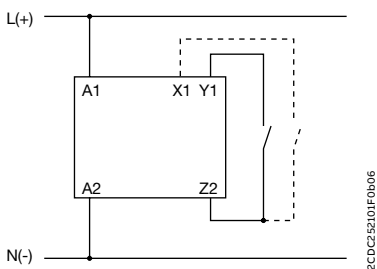

2CDC252105F0606

Triggering of the control inputs (volt-free) with a proximity switch (3 wire)¹⁾

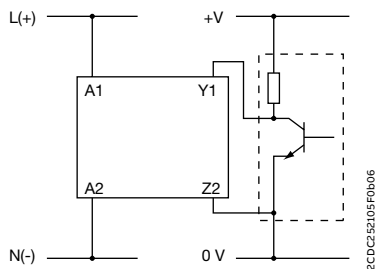

2CDC252105F0606

1) no galvanic isolation between A1/A2 and Y1/Z2

CT-S range

Technical diagrams

Wiring notes

Control inputs (voltage-related triggering)

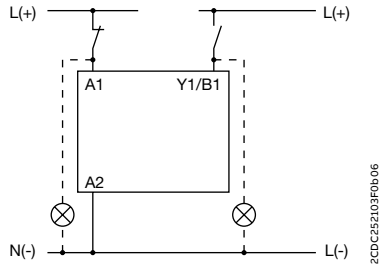
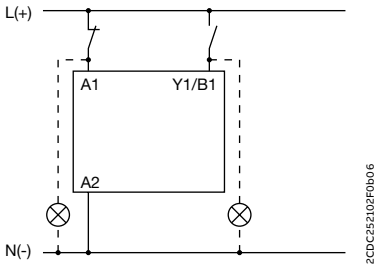

Remote potentiometer

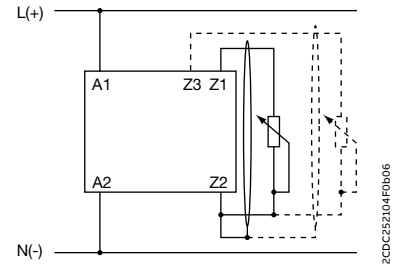

The control input Y1/B1 is triggered with electric potential against A2. It is possible to use the control supply voltage from terminal A1 or any other voltage within the rated control supply voltage range.

Dimensional drawings in mm and inches

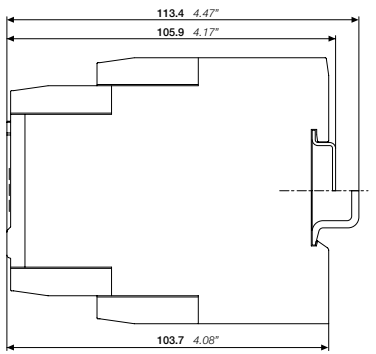

Main device

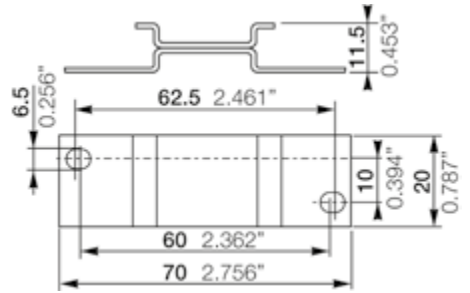
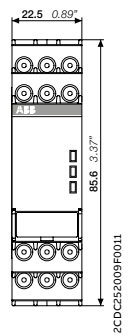

ADP.01 adapter for screw mounting

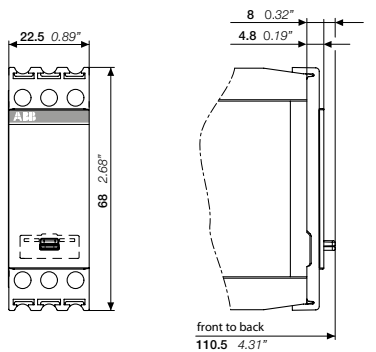

COV.11 sealable transparent cover

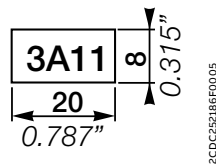

MAR.01 marker label



Time relays for building applications

Table of contents

53	Applications
54	Benefits and advantages
56	Selection table
57	Ordering details
58	Technical data
62	Technical diagrams

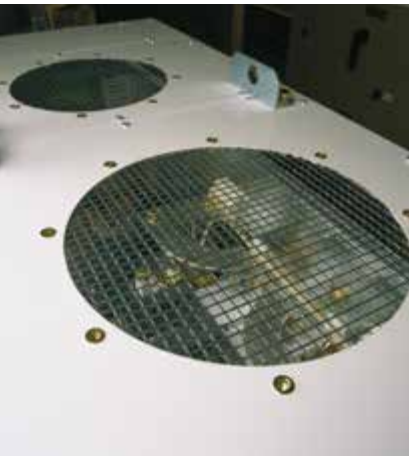

Time relays for building applications

Applications

The CT-D range is designed in a modular housing, making it well suited for building and residential applications. In just 12 order codes the CT-D range covers all the main timing functions needed for building automation, safely and reliably.



A typical application for timers is delayed switching. Switching several rows of lamps on and off in corridors, stairwells, staircases, etc, is a widespread application in which the excellent functionality of the CT-D timers is undisputed.



Air conditioning systems, heaters and fans can be found everywhere in buildings - just like the CT-D timers long used to switch them. On-delay, off-delay and a range of other functions cover all requirements.



Elevators, escalators, gates, compressors and doors - here too ABB timers ensure optimum and time-delayed opening as required. ABB's CT-D timers cover most functions with just 12 order codes.

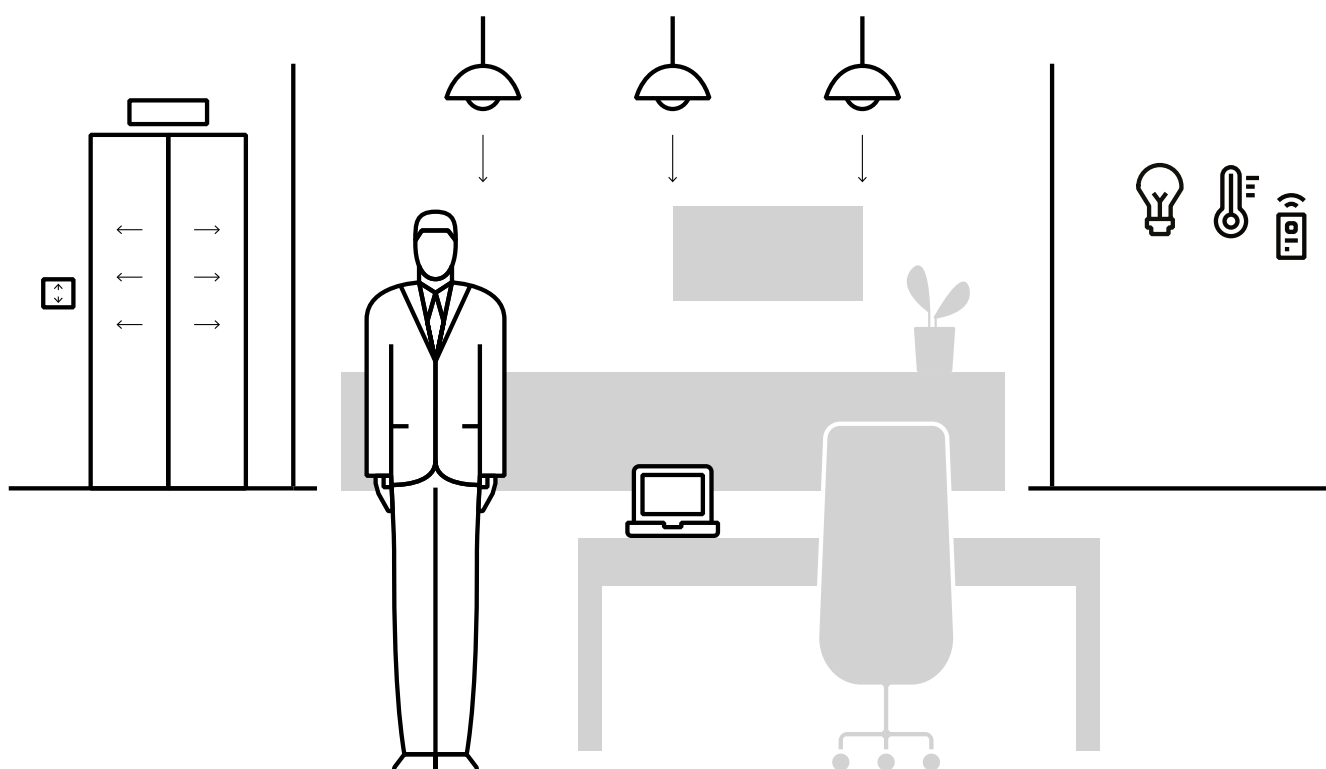

CT-D range

Benefits and advantages



The CT-D range is ideal for building applications and installation panels, due to its compact modular housing. For maximum flexibility in operation, nine single-function as well as two multifunction devices with seven timing functions are available. The devices offer four or seven time ranges from 0.05 seconds up to 100 hours. Their wide supply voltage range allows their use in applications worldwide.

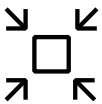

Space savings

The CT-D range is ideal for installation panels thanks to its compact modular housing. The housing's design helps make the status and configuration more clearly visible. The CT-D range also offers a higher output current than standard industrial types. As well as the 1 c/o contacts, ABB offers devices with 2 c/o contacts for maximum flexibility.



Easy to install

Direct reading scales help make time setting quick and easy. A pre-selection for the time range together with an additional scale for fine adjustments help improve installation efficiency. For more flexibility, the delay time can even be changed when processes are running, making optimization to fit the application even simpler. All devices can be mounted and demounted tool-free.



Global availability

The CT-D range fulfills various global standards and approvals, supporting business worldwide. Additionally, all devices from the CT-D range have a wide supply voltage from 24-48 V DC and 24-240 V AC, making it ideal for the use in installation panels around the world.

CT-D range

Operating controls



Connection terminals

Wide terminal spacing makes connection of wires simpler: 2 x 1.5 mm² (2 x 16 AWG) with wire end ferrules or 2 x 2.5 mm² (2 x 14 AWG) without ferrules.



Preselection of the time range









Direct reading scales

Direct setting of the time delay without any additional calculation provides accurate time delay adjustment.



Selection of the timing function

-  ON-delay
-  OFF-delay with aux. voltage
-  Impulse-ON
-  Impulse-OFF with aux. voltage
-  Flasher starting with ON
-  Flasher starting with OFF
-  Pulse former

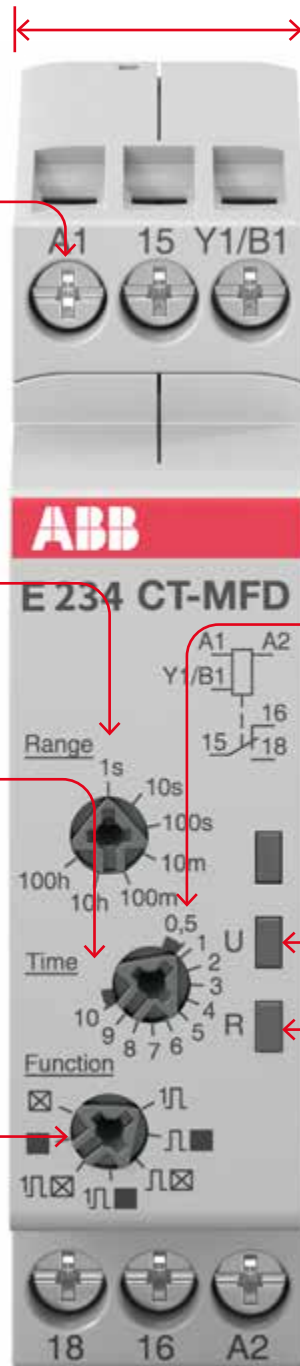

Width 17.5 mm

With a width of just 17.5 mm, the CT-D range timers are ideally suited for installation in distribution panels.





Fine adjustment of the time delay



LEDs for status indication

All actual operational states are displayed by front-facing LEDs, thus simplifying commissioning and troubleshooting.

- U - green LED:
 -  control supply voltage applied /
 -  timing
- R, R1, R2 - yellow LED:
 -  output relay energized

CT-D range

Ordering details



2CDC251002R0018

CT-MFD.12



2CDC251002R0018

CT-ERD.22

- Control input with voltage-related triggering
- No triggering

Description

The CT-D range with its modular design is a perfect solution for installation panels. For maximum flexibility in operation, 10 single-function as well as two multifunction devices with seven timing functions are available. The devices offer four or seven time ranges from 0.05 seconds up to 100 hours. Their wide input range allows their use in applications worldwide.

Ordering details

Timing function	Rated control supply voltage	Time ranges	Control input	Output	Type	Order code	Weight (1 pc) kg (lb)
Multi ¹⁾	24-240 V AC 24-48 V DC	7 (0.05 s - 100 h)	■	1 c/o	CT-MFD.12	1SVR500020R0000	0.060 (0.132)
Multi ¹⁾	12-240 V AC/DC	7 (0.05 s - 100 h)	■	2 c/o	CT-MFD.21	1SVR500020R1100	0.065 (0.143)
ON-delay	24-240 V AC 24-48 V DC	7 (0.05 s - 100 h)	-	1 c/o	CT-ERD.12	1SVR500100R0000	0.060 (0.132)
			-	2 c/o	CT-ERD.22	1SVR500100R0100	0.065 (0.143)
OFF-delay			■	1 c/o	CT-AHD.12	1SVR500110R0000	0.060 (0.132)
			■	2 c/o	CT-AHD.22	1SVR500110R0100	0.065 (0.143)
Impulse-ON			-	1 c/o	CT-VWD.12	1SVR500130R0000	0.060 (0.132)
Flasher starting with ON					CT-EBD.12	1SVR500150R0000	
Pulse generator		2×7 (0.05 s - 100 h)	■		CT-TGD.12 ²⁾	1SVR500160R0000	0.060 (0.132)
			■	2 c/o	CT-TGD.22 ²⁾	1SVR500160R0100	0.065 (0.143)
Star-delta change-over		4 (0.05 s - 10 min)	-	2 n/o	CT-SDD.22 ³⁾	1SVR500211R0100	0.065 (0.143)
			-		CT-SAD.22 ⁴⁾	1SVR500210R0100	

¹⁾ Functions: ON-delay, OFF-delay with auxiliary voltage, Impulse-ON, Impulse-OFF with auxiliary voltage, Flasher starting with ON, Flasher starting with OFF, Pulse former

²⁾ ON and OFF times adjustable independently: 2 x 7 time ranges 0.05 s - 100 h



³⁾ Transition time 50 ms fixed

⁴⁾ Transition time adjustable

CT-D range

Technical data

Data at $T_a = 25\text{ °C}$ and rated values, unless otherwise indicated

		CT-D with 1 c/o contact	CT-D with 2 c/o contacts	CT-MFD.21
Input circuit - Supply circuit				
Rated control supply voltage U_s		24-240 V AC / 24-48 V DC		12-240 V AC/DC
Rated control supply voltage U_s tolerance		-15...+10 %		
Rated frequency		DC or 50/60 Hz		
Frequency range AC		47-63 Hz		
Typical power consumption		max. 3.5 VA		
Power failure buffering time		min. 20 ms		
Release voltage		> 10 % of the minimum rated control supply voltage U_s		
Input circuit - Control circuit				
Control input, control function	A1-Y1/B1	start timing external		
Kind of triggering		voltage-related triggering		
Resistance to reverse polarity		yes		
Parallel load / polarized		yes / yes		
Maximum cable length to the control inputs		50 m - 100 pF/m		
Minimum control pulse length		20 ms		
Control voltage potential		see rated control supply voltage		
Current consumption of the control input				
	24 V DC	3.8 mA (CT-AHD.12) 3.9 mA (CT-MFD.12) 1.0 mA (CT-TGD.12)	0.9 mA (CT-AHD.22, CT-TGD.22)	0.4 mA
	115 V AC	23.9 mA (CT-AHD.12) 23.0 mA (CT-MFD.12) 1.3 mA (CT-TGD.12)	3.2 mA (CT-AHD.22, CT-TGD.22)	0.3 mA
	230 V AC	26.9 mA (CT-AHD.12) 26.0 mA (CT-MFD.12) 1.6 mA (CT-TGD.12)	6.4 mA (CT-AHD.22, CT-TGD.22)	0.7 mA
Timing circuit				
Time ranges	7 time ranges 0.05 s - 100 h	1.) 0.05-1 s 2.) 0.5-10 s 3.) 5-100 s 4.) 0.5-10 min 5.) 5-100 min 6.) 0.5-10 h 7.) 5-100 h		
	4 time ranges 0.05 s - 10 min (CT-SDD, CT-SAD)	1.) 0.05-1 s 2.) 0.5-10 s 3.) 5-100 s 4.) 0.5-10 min		
Recovery time		< 50 ms		
Accuracy within the rated control supply voltage tolerance		$\Delta t < 0.005\ % / V$		
Accuracy within the temperature range		$\Delta t < 0.06\ % / \text{°C}$		
Repeat accuracy (constant parameters)		$\Delta t < \pm 0.5\ %$		
Setting accuracy of time delay		$\pm 10\ %$ of full-scale value		
Star-delta transition time	CT-SDD/ CT-SAD	fixed 50 ms / adjustable: 20 ms, 30 ms, 40 ms, 50 ms, 60 ms, 80 ms or 100 ms		
Star-delta transition time tolerance	CT-SDD / CT-SAD	$\pm 3\ ms$		
Indication of operational states				
Control supply voltage / timing	U: green LED	 : control supply voltage applied  : timing		
Relay energized	R, R1, R2: yellow LED	 : output relay energized		
Operating elements and controls				
Adjustment of the time range		front-face rotary switch, direct reading scales		
Fine adjustment of the time value		front-face potentiometer		
Preselection of the timing function at multifunction devices		front-face rotary switch, direct reading scales		
Adjustment of the transition time	CT-SAC	front-face potentiometer		

CT-D range

Technical data

		CT-D with 1 c/o contact	CT-D with 2 c/o contacts	CT-MFD.21
Output circuit				
Kind of output	15-16/18	Relay, 1 c/o contact	-	
	15-16/18; 25-26/28	-	Relay, 2 c/o contacts	
	17-18; 17-28		Relay, 2 n/o contacts (CT-SDC, CT-SAC)	
Contact material		AgNi alloy, Cd free		
Rated operational voltage U_e		250 V		
Minimum switching voltage / minimum switching current		12 V / 100 mA		
Maximum switching voltage / maximum switching current		250 V AC / 6 A	250 V AC / 5 A	
Rated operational current I_e	AC-12 (resistive) at 230 V	6 A	5 A	
	AC-15 (inductive) at 230 V	3 A	3 A	n/o: 3 A n/c: 0.75 A
	DC-12 (resistive) at 24 V	6 A	5 A	
	DC-13 (inductive) at 24 V	2 A	2 A	1 A
AC rating (UL 508)	utilization category (Control Circuit Rating Code)	B 300		n/o: B 300 n/c: C 300
	max. rated operational voltage	300 V AC		
	maximum continuous thermal current at B300	5 A		n/o: 5 A
	maximum continuous thermal current at C300	-		n/c: 2.5 A
	max. making/breaking apparent power at B300	3600 VA / 360 VA		n/o: 3600/360 VA
	max. making/breaking apparent power at C300	-		n/c: 1800/180 VA
	Mechanical lifetime	30 x 10 ⁶ switching cycles		
Electrical lifetime	0.1 x 10 ⁶ switching cycles			
Max. fuse rating to achieve short-circuit protection	n/c contact	6 A fast-acting		
	n/o contact	10 A fast-acting		6 A fast-acting
General data				
Mean time between failures (MTBF)	on request			
Duty cycle	100%			
Dimensions	see 'Dimensional drawings'			
Mounting	DIN rail (IEC/EN 60715), snap-mounting without any tool			
Mounting position	any			
Minimum distance to other units	horizontal / vertical	no / no		
Material of housing	UL 94 V-2			
Degree of protection	housing / terminals	IP50 / IP20		
Electrical connection				
Connecting capacity	fine-stranded with(out) wire and ferrule	2 x 0.5-1.5 mm ² (2 x 20-16 AWG)		
		1 x 0.5-2.5 mm ² (1 x 20-14 AWG)		
	rigid	2 x 0.5-1.5 mm ² (2 x 20-16 AWG)		
		1 x 0.5-4 mm ² (1 x 20-12 AWG)		
Stripping length	7 mm (0.28 in)			
Tightening torque	0.5-0.8 Nm (4.43-7.08 lb.in)			
Environmental data				
Ambient temperature range	operation / storage	-20 ... +60 °C / -40 ... +85 °C		
Climatic class	EC/EN 60721-3-3	3k22		
Relative humidity range	25-85%			
Vibration, sinusoidal	IEC/EN 60068-2-6	20 m/s ² ; 10 cycles, 10...150...10 Hz		
Shock (half-sine)	IEC/EN 60068-2-27	150 m/s ² , 11 ms		

CT-D range

Technical data

		CT-D with 1 c/o contact	CT-D with 2 c/o contacts	CT-MFD.21
Isolation data				
Rated insulation voltage U_i	input circuit / output circuit	300 V		
	output circuit 1 / output circuit 2	not available	300 V	300 V
Rated impulse withstand voltage U_{imp}	between all isolated circuits	4 kV; 1.2/50 μ s		
Power-frequency withstand voltage test (test voltage)	between all isolated circuits	2.5 kV; 50 Hz; 60 s		
Basic insulation (IEC/EN 60664-1)	input circuit / output circuit	300 V		
Protective separation (IEC/EN 60664-1)	input circuit / output circuit	250 V at pollution degree 2 / overvoltage category II		
Pollution degree (IEC/EN 60664-1)		3		
Overvoltage category (IEC/EN 60664-1)		III		
Standards / Directives				
Standards		IEC/EN 61812-1		
Low Voltage Directive		2014/35/EU		
EMC Directive		2014/30/EU		
RoHS Directive		2011/65/EU		
Electromagnetic compatibility				
Interference immunity to		IEC/EN 61000-6-2, IEC/EN 61000-6-1		
electrostatic discharge	IEC/EN 61000-4-2	Level 3 (6 kV / 8 kV)		
radiated, radio-frequency, electromagnetic field	IEC/EN 61000-4-3	Level 3 (10 V / m)		
electrical fast transient / burst	IEC/EN 61000-4-4	Level 3 (2 kV / 5 kHz)		
surge	IEC/EN 61000-4-5	Level 4 (2 kV L-L)		
conducted disturbances, induced by radio-frequency fields	IEC/EN 61000-4-6	Level 3 (10 V)		
Interference emission		IEC/EN 61000-6-3, IEC/EN 61000-6-4		
high-frequency radiated	IEC/CISPR 22, EN 55022	Class B		
high-frequency conducted	IEC/CISPR 22, EN 55022	Class B		

CT-D range

Technical diagrams

Example of application - Star-delta changeover

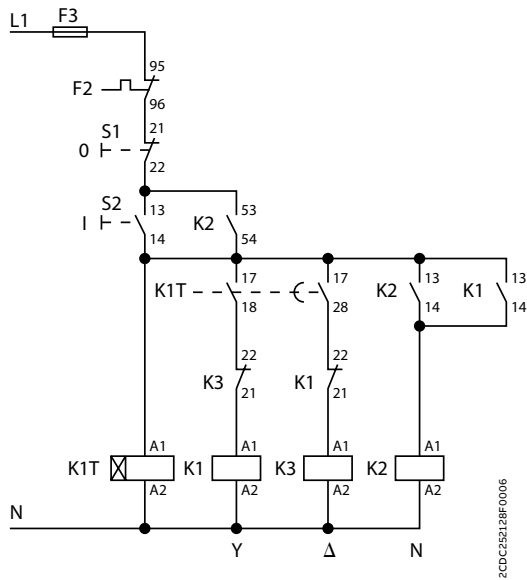

Control circuit diagram

2CDC252128F0006

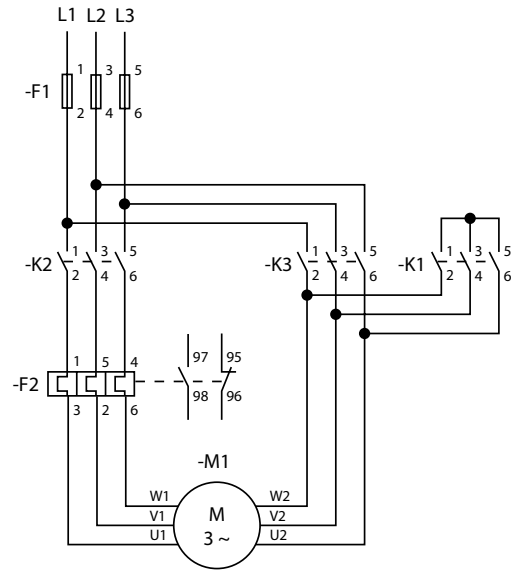

Power circuit diagram

2CDC253009F00012

CT-D range

Technical diagrams

Connection diagrams

CT-MFD.21

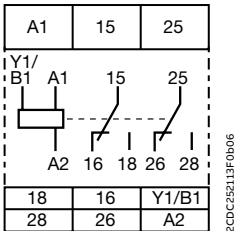

A1-A2	Supply: 12-240 V AC/DC
A1-Y1/B1	Control input
15-16/18	1st c/o contact
25-26/28	2nd c/o contact

CT-MFD.12

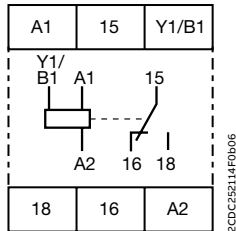

A1-A2	Supply: 24-48 V DC or 24-240 V AC
A1-Y1/B1	Control input
15-16/18	1st c/o contact

CT-ERD.22

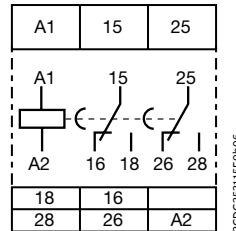

A1-A2	Supply: 24-48 V DC or 24-240 V AC
15-16/18	1st c/o contact
25-26/28	2nd c/o contact

CT-ERD.12

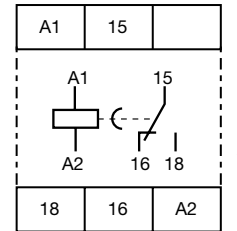

A1-A2	Supply: 24-48 V DC or 24-240 V AC
15-16/18	1st c/o contact

CT-AHD.22

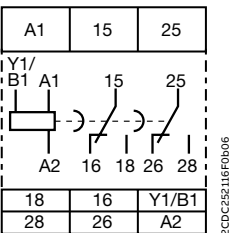

A1-A2	Supply: 24-48 V DC or 24-240 V AC
A1-Y1/B1	Control input
15-16/18	1st c/o contact
25-26/28	2nd c/o contact

CT-AHD.12

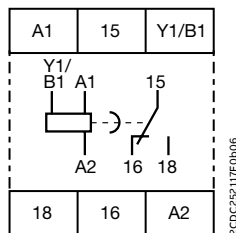

A1-A2	Supply: 24-48 V DC or 24-240 V AC
A1-Y1/B1	Control input
15-16/18	1st c/o contact

CT-VWD.12

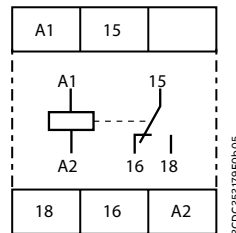

A1-A2	Supply: 24-48 V DC or 24-240 V AC
15-16/18	1st c/o contact

CT-EBD.12

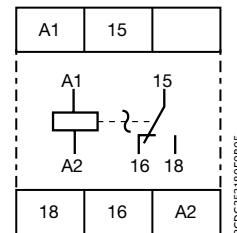

A1-A2	Supply: 24-48 V DC or 24-240 V AC
15-16/18	1st c/o contact

CT-TGD.22

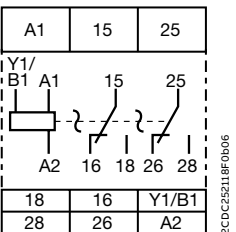

A1-A2	Supply: 24-48 V DC or 24-240 V AC
A1-Y1/B1	Control input
15-16/18	1st c/o contact
25-26/28	2nd c/o contact

CT-TGD.12

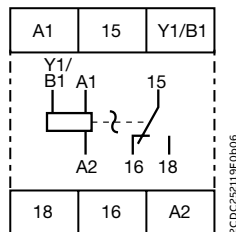

A1-A2	Supply: 24-48 V DC or 24-240 V AC
A1-Y1/B1	Control input
15-16/18	1st c/o contact

CT-SDD.22

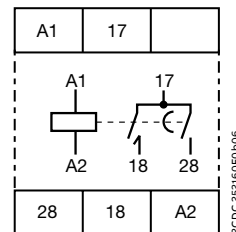

A1-A2	Supply: 24-48 V DC or 24-240 V AC
17-18	1st n/o contact (star contactor)
17-28	2nd n/o contact (delta contactor)

CT-SAD.22

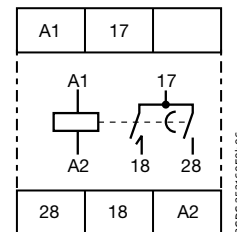

A1-A2	Supply: 24-48 V DC or 24-240 V AC
17-18	1st n/o contact (star contactor)
17-28	2nd n/o contact (delta contactor)

CT-D range

Technical diagrams

Load limit curves

AC load (resistive)

CT-D.1x

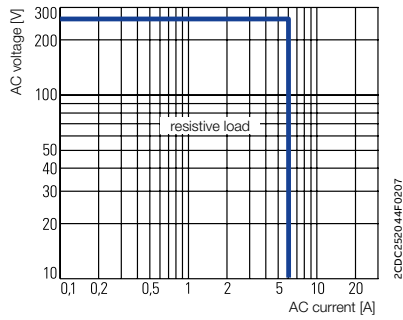

CT-D.2x

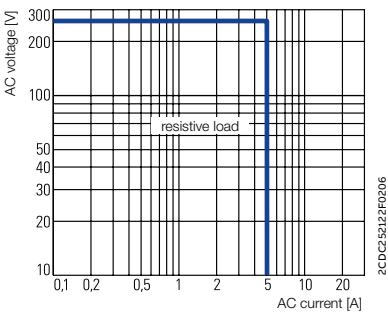

DC load (resistive)

CT-D.1x

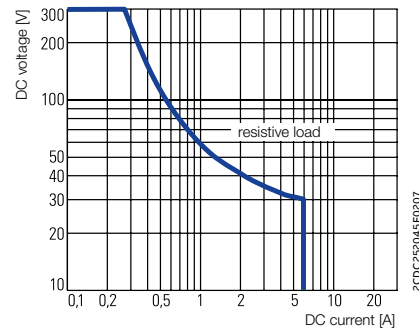

CT-D.2x

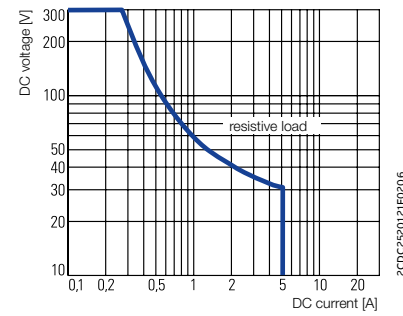

Derating factor F for inductive AC load

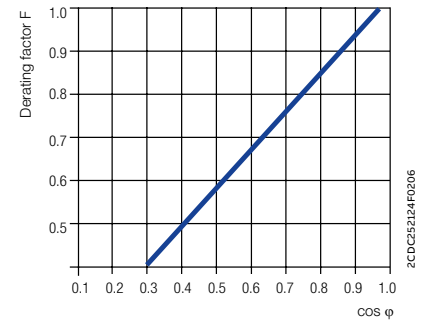

Contact lifetime

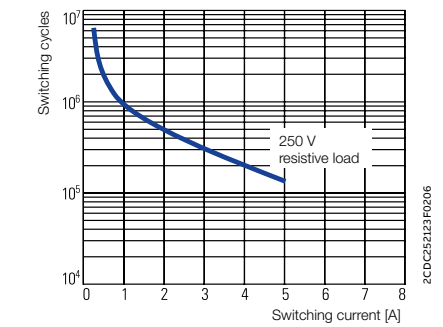

Wiring notes for devices with control input

A parallel load to the control input is possible

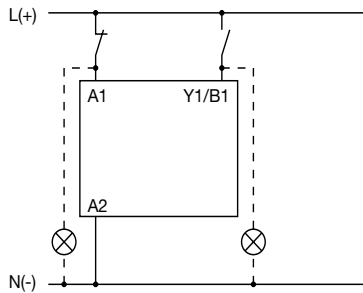

Dimensional drawings in mm and inches

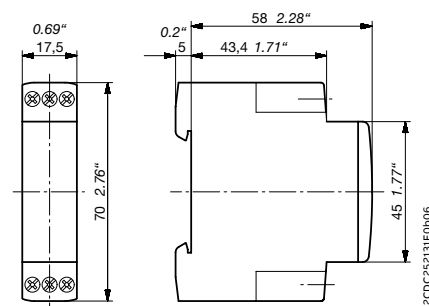

CT-D devices with 1 c/o contact or 2 n/o contacts

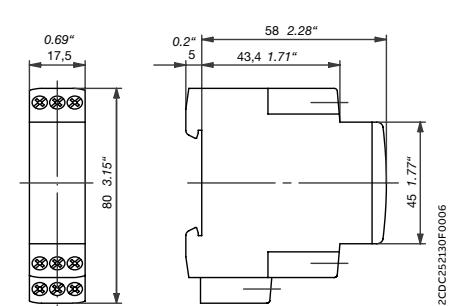

CT-D devices with 2 c/o contacts





Timing functions

Timing functions

CT-C, CT-S, CT-D

On delay functions (Delay on make) ☒

On-delay



This function requires a continuous control supply voltage for timing. Timing begins when a control supply voltage is applied. When the selected time delay is complete, the output relay energizes. If the control supply voltage is interrupted, the output relay de-energizes and the time delay is reset.

ON-delay accumulative

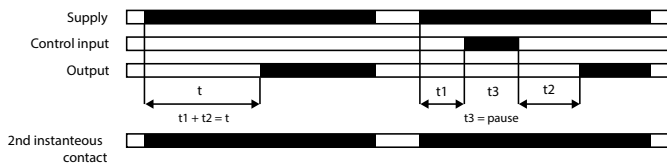

This function requires a continuous control supply voltage for timing. Timing begins when a control supply voltage is applied. When the selected time delay is complete, the output relay energizes. Timing can be paused by closing the control input.

The elapsed time t_1 is stored and continues from this time value when the control input is re-opened. If the control supply voltage is interrupted, the output relay de-energizes and the time delay is reset.

OFF delay functions (Delay on break, retriggerable Watchdog) ■

OFF-delay with auxiliary voltage

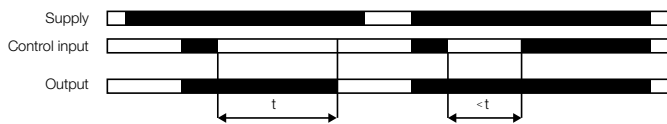

This function requires a continuous control supply voltage for timing. If the control input is closed, the output relay energizes immediately. If the control input is opened, the time delay starts. When the selected time delay is complete, the output relay de-energizes.

If control input re-closes before the time delay is complete, the time delay is reset and the output relay does not change state. Timing starts again when the control input re-opens. If the control supply voltage is interrupted, the output relay de-energizes and the time delay is reset.

OFF-delay without auxiliary voltage

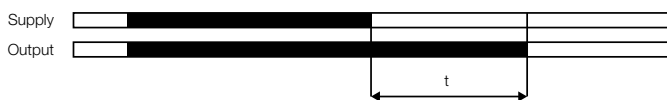

The OFF-delay function without auxiliary voltage does not require a continuous control supply voltage for timing. Applying a control supply voltage energizes the output relay. If the control supply voltage is interrupted, the OFF-delay starts. When timing is complete, the output relay de-energizes.

If a control supply voltage is re-applied before the time delay is complete, the time delay is reset and the output relay remains energized. A control supply voltage must be applied for the minimum energizing time (200 ms), for correct operation.

Timing functions

CT-C, CT-S, CT-D

OFF-delay with auxiliary voltage, accumulative

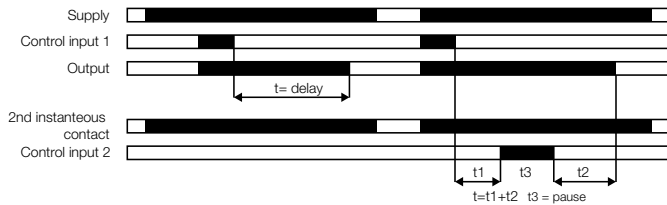

This function requires a continuous control supply voltage for timing. If the control input is closed, the output relay energizes immediately. If the control input is opened, the time delay starts. When the selected time delay is complete, the output relay de-energizes. If the control input closes before the time delay is complete, the time delay is reset and the output relay does not change state. Timing starts again when the control input reopens.

Pause timing / Accumulative OFF-delay: Timing can be paused by closing control 2. The elapsed time t_1 is stored and continues from this time value when control input 2 is re-opened. This can be repeated as often as required. If the control supply voltage is interrupted, the output relay de-energizes and the time delay is reset.

Impulse-ON functions 1

Impulse-ON (interval)

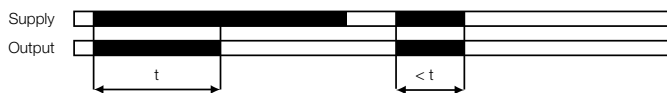

This function requires a continuous control supply voltage for timing. The output relay energizes immediately when the control supply voltage is applied and de-energizes after the set pulse time is complete. If the control supply voltage is interrupted, the output relay de-energizes and the time delay is reset.

Impulse-ON, accumulative

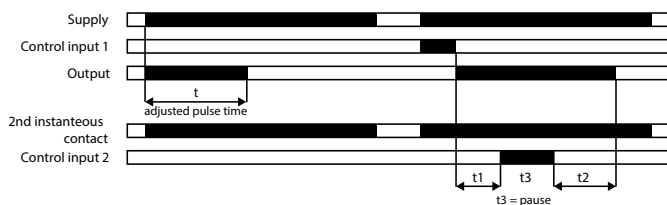

This function requires a continuous control supply voltage for timing. The output relay energizes immediately when the control supply voltage is applied and de-energizes after the set pulse time is complete. If control input 1 is open, timing begins when a control supply voltage is applied. Or, if control a supply voltage is already applied, opening control input 1 starts timing. When the selected pulse time is complete, the output relay de-energizes. Closing control input 1, before the pulse time is complete, de-energizes the output relay and resets the pulse time.

Pause timing / Accumulative impulse-ON: Timing can be paused by closing control input 2. The elapsed time t_1 is stored and continues from this time value when control input 2 is re-opened. This can be repeated as often as required. If the control supply voltage is interrupted, the output relay de-energizes and the time delay is reset.

Timing functions

CT-C, CT-S, CT-D

Impulse-OFF functions 1

Impulse-OFF with auxiliary voltage

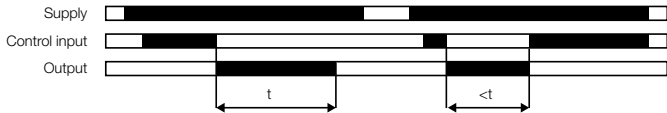

This function requires a continuous control supply voltage for timing. The output relay energizes immediately when the control input is de-energized and the output de-energizes after the set pulse time is complete. If the control supply voltage is interrupted, the output relay de-energizes and the time delay is reset.

Impulse-OFF without auxiliary voltage

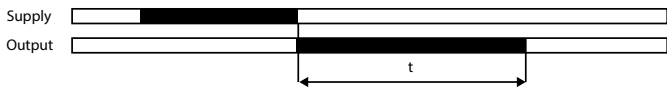

This function does not require a continuous control supply voltage for timing. If the control supply voltage is interrupted, the output relay energizes and the OFF time starts. When timing is complete, the output relay de-energizes. If a control supply voltage is re-applied before the time delay is complete, the time delay is reset and the output relay de-energizes. A control supply voltage must be applied for the minimum energizing time (200 ms), for proper operation.

Impulse-OFF with auxiliary voltage (Trailing edge interval) accumulative

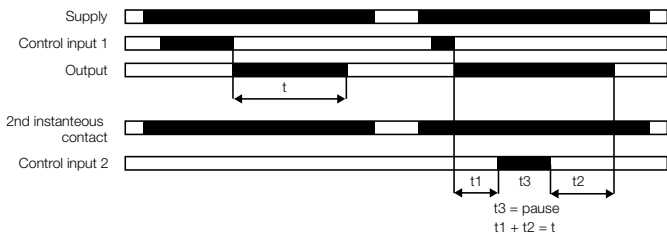

This function requires a continuous control supply voltage for timing. If a control supply voltage is applied, opening control input 1 energizes the output relay immediately and starts timing. When the selected pulse time is complete, the output relay de-energizes. Closing control input 1, before the pulse time is complete, de-energizes the output relay and resets the pulse time. Pause timing / Accumulative impulse-OFF: Timing can be paused by closing control input 2. The elapsed time t1 is stored and continues from this time value when control input 2 is re-opened. This can be repeated as often as required. If the control supply voltage is interrupted, the output relay de-energizes and the time delay is reset.

Impulse-ON and Impulse-OFF functions 1

Impulse-ON and impulse-OFF

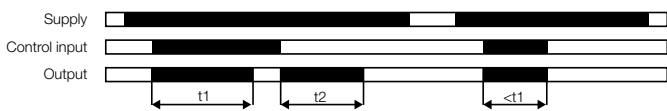

This function requires a continuous control supply voltage for timing. If a control supply voltage is applied, closing the control input energizes the output relay immediately and starts the pulse time t1. When t1 is complete, the output relay de-energizes. Re-opening the control input energizes the output relay immediately and starts the pulse time t2. When t2 is complete, the output relay de-energizes. t1 and t2 are independently adjustable. If the control input changes state before the pulse time is complete, the output relay de-energizes and the pulse time is reset. If the control input changes state again, the interrupted pulse time restarts. If the control supply voltage is interrupted, the output relay de-energizes and the time delay is reset.

Timing functions

CT-C, CT-S, CT-D

Flasher starting with ON functions

Flasher starting with ON



Applying a control supply voltage starts timing with symmetrical ON & OFF times. The cycle starts with an ON time first. If the control supply voltage is interrupted, the output relay de-energizes and the time delay is reset.

Flasher with reset starting with ON

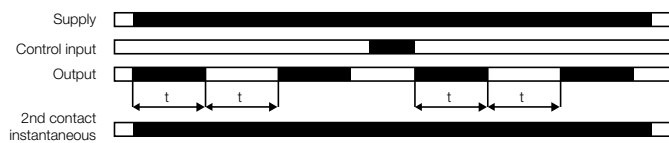

Applying a control supply voltage starts timing with symmetrical ON & OFF times. The cycle starts with an ON time first. The time delay can be reset by closing the control input. Opening the control input starts the timer pulsing again with symmetrical ON & OFF times. If the control supply voltage is interrupted, the output relay de-energizes and the time delay is reset.

Flasher starting with OFF functions

Flasher starting with OFF



Applying a control supply voltage starts timing with symmetrical ON & OFF times. The cycle starts with an OFF time first. If the control supply voltage is interrupted, the output relay de-energizes and the time delay is reset.

Flasher with reset starting with OFF

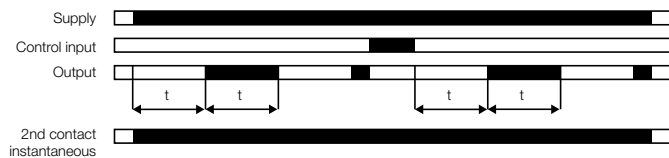

Applying a control supply voltage starts timing with symmetrical ON & OFF times. The cycle starts with an OFF time first. The time delay can be reset by closing the control input. Opening the control input starts the timer pulsing again with symmetrical ON & OFF times. If the control supply voltage is interrupted, the output relay de-energizes and the time delay is reset.

Flasher starting with ON or OFF functions

Flasher starting with ON or OFF

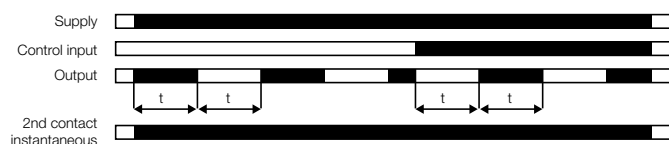

Applying a control supply voltage starts timing with symmetrical ON / OFF times. If the control input is open while supply voltage is connected the cycle starts with an ON time first. If the control input is closed while supply voltage is connected the cycle starts with an OFF time first.

Timing functions

CT-C, CT-S, CT-D

Pulse former

Puls former (single shot)

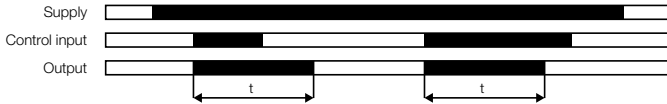

This function requires a continuous control supply voltage for timing. Closing the control input energizes the output relay immediately and starts timing. Operating the control input during the time delay has no effect. When the selected ON time is complete, the output relay de-energizes. After the ON time is complete, it can be restarted by closing the control input. If control supply voltage is interrupted, the output relay de-energizes and the time delay is reset.

Single-pulse generator

Single-pulse generator, starting with OFF

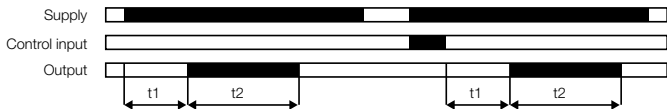

This function requires a continuous control supply voltage for timing. Applying a control supply voltage while the control input is open energizes the output relay after the OFF time t_1 is complete. When the following ON time t_2 is complete, the output relay de-energizes. Alternatively, when a control supply voltage is already applied, the timing process can be started by opening control input. Closing the control input with a control supply voltage applied, de-energizes the output relay and re-sets the time delay. The ON & OFF times are independently adjustable.

Pulse generator

Starting with the ON or OFF time
(Recycling unequal times, ON or OFF first)

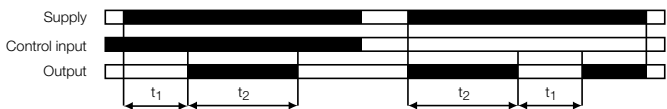

This function requires a continuous control supply voltage for timing. Applying a control supply voltage, with closed control input, starts timing with an OFF time first. Applying a control supply voltage, with open control input, starts timing with an ON time first. If the control supply voltage is interrupted, the output relay de-energizes and the time delay is reset.

Impulse with delay

Fixed impulse with adjustable time delay



This function requires a continuous control supply voltage for timing. The time delay t_1 starts when a control supply voltage is applied. When t_1 is complete, the output relay energizes for the fixed impulse time t_2 of 500 ms. If the control supply voltage is interrupted, the time delay is re-set. The output relay does not change state.

Adjustable impulse with fixed time delay

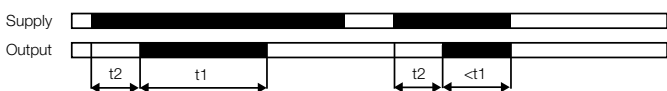

This function requires a continuous control supply voltage for timing. As soon as the control supply voltage is applied, the time delay t_2 (fixed 500 ms) starts. When t_2 is complete, the output relay energizes and the selected pulse time t_1 starts. When t_1 is complete, the output relay de-energizes. If the control supply voltage is interrupted, the pulse time is reset and the output relay de-energizes.

Timing functions

CT-C, CT-S, CT-D

ON- and OFF-delay

Symmetrical ON- and OFF-delay ¹⁾

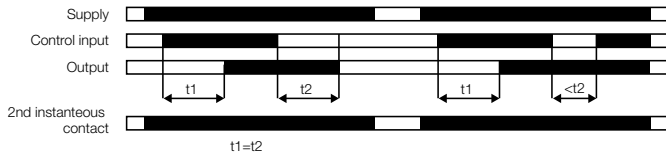

This function requires a continuous control supply voltage for timing. Closing the control input starts the ON-delay time t_1 . When timing is complete, the output relay energizes. Opening the control input starts the OFF-delay time t_2 . When the OFF-delay t_2 is complete, the output relay de-energizes. If the control input opens before the ON-delay ($<t_1$) is complete, the time delay is reset and the output relay remains de-energized. If control input closes before the OFF-delay time ($<t_2$) is complete, the time delay is reset and the output relay remains energized.

1) Variant with 2nd control input for pause timing is available too.

Asymmetrical ON- and OFF-delay

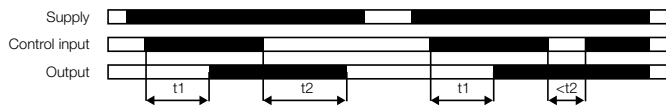

This function requires a continuous control supply voltage for timing. Closing the control input starts the ON-delay t_1 . When timing is complete, the output relay energizes. Opening the control input starts the OFF-delay t_2 . When the OFF-delay is complete, the output relay de-energizes. The ON-delay and OFF-delay are independently adjustable. If the control input opens before the ON-delay is complete ($<t_1$), the time delay is reset and the output relay remains de-energized. If the control input closes before the OFF-delay is complete ($<t_2$), the time delay is reset and the output relay remains energized. If the control supply voltage is interrupted, the output relay de-energizes and the time delay is reset.

Star-Delta changeover (with impulse)

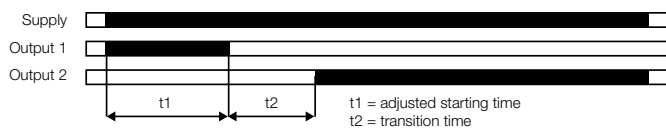

This function requires a continuous control supply voltage for timing. Applying a control supply voltage, energizes the star contactor connected to output 1 and begins the set starting time t_1 . When the starting time is complete, the first output contact de-energizes the star contactor. When the transition time t_2 is complete, the second output contact energizes the delta contactor. The delta contactor remains energized as long as the control supply voltage is applied. t_2 is fixed to 50 ms or in some variants adjustable.

Further functions

ON/OFF function



This function is used for test purposes during commissioning and troubleshooting. If the selected maximum value of the time range is smaller than 300 hours (front-face potentiometer "Time sector" \neq 300 h), applying a control supply voltage energizes the output relay immediately. Interrupting the control supply voltage, de-energizes the output relay. If the selected maximum value of the time range is 300 hours (front-face potentiometer "Time sector" = 300 h) and a control supply voltage is applied the output relay does not energize.

Alternating without time delay



The alternating function is designed to evenly use the electro-mechanical resource of a twin pump, compressors and generators. The alternating relay has two normally open contacts, which are closed alternately each time the control supply voltage is applied.



Measuring and monitoring relays

Table of contents

74	Benefits and advantages
76	Offer overview
79	Applications
81	Single-phase monitoring relays
105	Three-phase monitoring relays
137	Grid feeding monitoring relays
151	Insulation monitoring relays for unearthed supply systems
181	Thermistor motor protection relays
203	Temperature monitoring relays with potentiometer
219	Smart temperature monitoring relays
239	Liquid level monitoring relays
261	Accessories

Measuring and monitoring relays

Benefits and advantages



Higher utility class
The plastic housing material used meets the requirements for the highest flammability class. (UL94 V-0 rated)



Snap-on housing
Tool-free DIN rail installation and deinstallation of the relay.



Sealable transparent cover
Protection against unauthorized changes of time and threshold values.

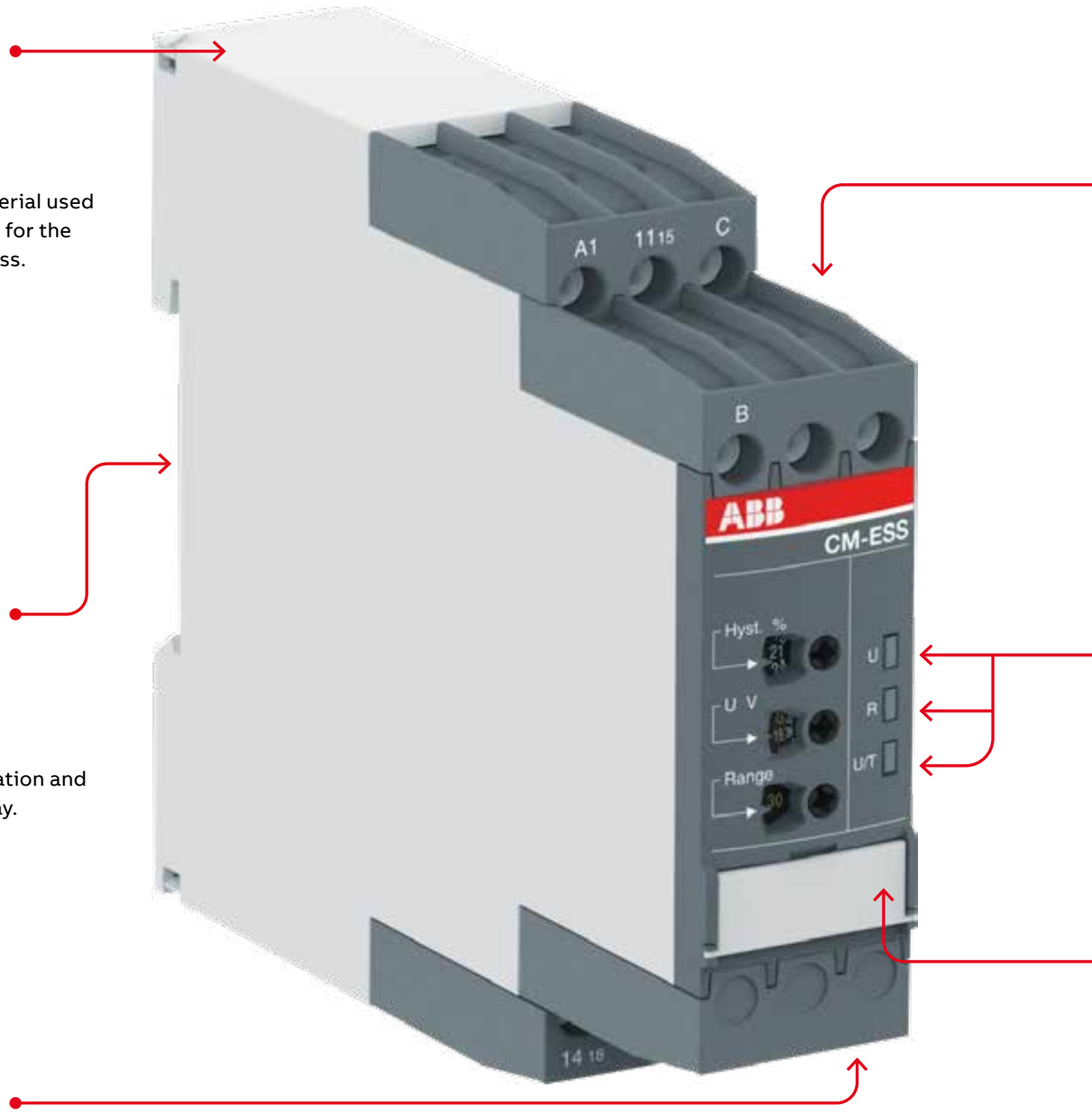

Measuring and monitoring relays

Benefits and advantages



Easy Connect technology

- Tool-free wiring and excellent vibration resistance.
- Push-in terminals provide connection of wires up to $2 \times 0.5 - 1.5 \text{ mm}^2$ (2 x 20 -16 AWG), rigid or fine-strand with or without wire end ferrules.
- Excellent vibration resistance – the right solution for harsh environments.



Double-chamber cage connection terminals

Double-chamber cage connection terminals provide connection of wires up to $2 \times 0.5-2.5 \text{ mm}^2$ (2 x 20-14 AWG) rigid or fine-strand, with or without wire end ferrules.



LEDs for status indication

All actual operational states are displayed by front-face LEDs, simplifying commissioning and troubleshooting.



Integrated marker label

Integrated marker labels allow the product to be marked quickly and simply. No additional marker labels are required.

Measuring and monitoring relays

Offer overview

Measuring and monitoring relays monitor and detect operating conditions with regard to phase, current, voltage, frequency, temperature, liquid level or insulation faults. The relays inform users about abnormal conditions and allow them to take necessary corrective actions before severe and costly failures can occur. Depending on the product model, measuring and monitoring relays are categorized into seven product families.

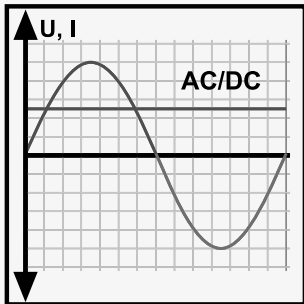

Single-phase current monitoring relays

- Monitoring of motor current consumption
- Monitoring of lighting installations and heating circuits
- Monitoring of transportation equipment overload
- Monitoring of locking devices, electromechanical brake gear and locked rotors

Single-phase voltage monitoring relays

- Speed monitoring of DC motors
- Monitoring of battery voltages and other supply networks

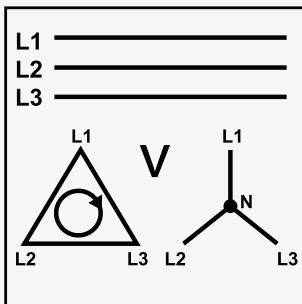

Three-phase monitoring relays

- Voltage monitoring of mobile three-phase equipment
- Protection of personnel and installations against phase reversal
- Monitoring of the supply voltage of machines and installations
- Protection of equipment against damage caused by unstable supply voltage
- Switching to emergency or auxiliary supply
- Protection of motors against damage caused by unbalanced phase voltages and phase loss
- Suitable for HVAC applications

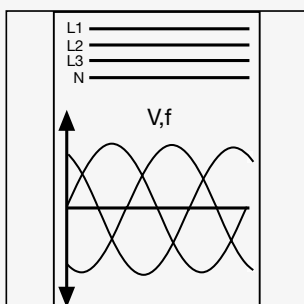

Grid feeding monitoring relays

The CM-UFD.M* range monitors all voltage and frequency parameters in a grid and ensures the safe feeding of decentrally produced electrical energy into the grid.

- Monitoring of the voltage with up to 2 thresholds for over- and undervoltage
- Monitoring of the frequency with up to 2 thresholds for over- and under-frequency
- ROCOF (rate of change of frequency) and vector shift detection
- In compliance with several local standards

Measuring and monitoring relays

Offer overview

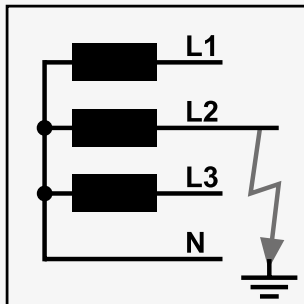

Insulation monitoring relays

- Monitoring of electrically isolated supply mains for insulation resistance failure
- Detection of initial faults
- Protection against earth faults

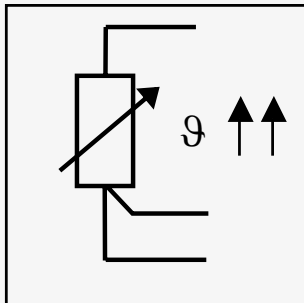

Temperature monitoring relays

Acquisition, messaging and regulation of temperatures of solid, liquid and gaseous media in processes and machines

- Motor and system protection
- Control panel temperature monitoring
- Frost monitoring
- Temperature limits for process variables, e.g. in the packing or electroplating industry
- Control of systems and machines like heating, air-conditioning and ventilation systems, solar collectors, heat pumps or hot water supply systems
- Bearing, gear oil and coolant monitoring

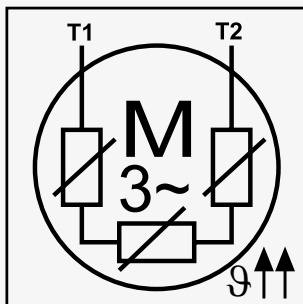

Thermistor motor protection

CM-MSE and CM-MSS provide full protection of motors with integrated PTC resistor sensors.

Protection of motors against thermal overload, e. g. caused by insufficient cooling, heavy load starting conditions, undersized motors, etc.

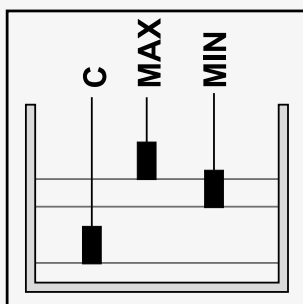

Liquid level monitoring relays

- Protection of pumps against dry running
- Protection against container overflow
- Control of liquid levels
- Detection of leaks
- Control of mixing ratios

Measuring and monitoring relays

Offer overview



CM-N range: Multifunctional range

- 45 mm wide housing
- Output contacts: 2 c/o (SPDT) contacts
- Continuous voltage range (24-240 V AC/DC) or single-supply
- Setting and operation via front-face operating controls
- Adjustment of threshold values and switching hysteresis via direct reading scale
- Adjustable time delays
- Integrated and snap-fitted front-face marker label
- Sealable transparent cover (accessory)



CM-S range: Universal and multifunctional range

- Only 22.5 mm wide housing
- Output contacts: 1 or 2 c/o (SPDT) contacts
- One supply voltage range or supplied by measuring circuit
- Setting and operation via front-face operating controls
- Adjustment of threshold values and switching hysteresis via direct reading scale
- Integrated and snap-fitted front-face marker
- Snap-on housing: The relays can be placed on a DIN rail tool-free - just snap it on or remove it tool-free
- Sealable transparent cover (accessory)



CM-E range: Economy range

- Only 22.5 mm wide housing
- Output contacts: 1 c/o contact or 1 n/o contact
- One supply voltage range
- One monitoring function
- Cost-efficient solution for OEM applications
- Preset monitoring ranges



CM-TCN range: Smart temperature monitoring relays

- 45 mm wide housing
- Output contacts: 3 c/o contact
- Wide supply voltage range (24-240 V AC/DC)
- A wide range of settings, that can be adjusted flexibly
- NFC parametrization via smartphone app
- Back-lit LCD for easy reading and parametrization
- Embedded Modbus RTU communication interface

Measuring and monitoring relays

Applications

ABB offers a wide selection of measuring and monitoring relays to suit a wide range of applications for businesses worldwide. Excellent vibration resistance with the Easy Connect terminal technology and railway certifications for selected products ensure the operability, even in harsh environments.



Automation panels

- Textile industry - measuring and monitoring of motor voltage and current overload of, for example, looms.
- Packaging industry - measuring and monitoring of motor voltage and current overload of, for example, conveyor belts.



Infrastructure

- Water and wastewater applications - monitoring the liquid level of water tanks and wastewater recycling plants.
- Lifts - status monitoring of the three phase mains of, for example, construction lifts, passenger lifts and escalators.
- Hoisting applications - construction cranes, harbor cranes.
- Railway.



Renewable energy

- Solar - monitoring of the insulation resistance and the frequency and voltage of the public grid to keep electrical grids stable and meet local requirements.
- Wind - temperature, current and voltage supervision of automation panels and electrical motors.



Buildings

- Lifts - status monitoring of the three phase mains of, for example, construction lifts, passenger lifts and escalators.
- HVAC - monitoring of grid parameters, control and protection of loads.





Single-phase monitoring relays

Table of contents

82	Benefits and advantages
84	Operating controls
86	Single-phase current monitoring relays
86	Selection table
87	Ordering details
88	Single-phase voltage monitoring relays
88	Selection table
89	Ordering details
90	Technical data
96	Technical diagrams
98	Function diagrams

Single-phase monitoring relays

Benefits and advantages



For the monitoring of currents and voltages in single-phase AC/DC systems, ABB's CM-range contains a wide selection of powerful and compact devices, all in an only 22.5 mm wide housing. This product range includes current and voltage monitoring relays for over- and undercurrent and voltage protection – from 3 mA to 15 A, and from 3 V to 600 V.



Continuous operation

Read the status of the relay at a glance: clear visualization of the device status via LEDs. Easy to adjust with rotary wheels and variants with push-in terminals make a quick and easy installation and setting possible.



Reliable in harsh conditions

All relays work reliably in environments with low temperatures down to -25 °C. Additionally, the housing fulfills the UL 94 V-0 flammability standard requirements. Together with the vibration resistant push-in terminals, the relay is not only reliable, no matter the environment temperature, but is also durable to shock and vibration. Save time as retightening is no longer needed, and enhance the reliability and safety of the equipment.



Easy installation

Like all devices from the measuring and monitoring portfolio, the single-phase monitoring relays are easily configurable via front facing potentiometers. Easy threshold configuration without calculation is accomplished by direct reading scales. For further configuration options, additional settings can be made via dip-switches, offering the flexibility to configure, for example, the working principle of the relays and the output configuration. The device can be set up before installation in the application and easy adjustments during the process are possible.

Single-phase monitoring relays

Benefits and advantages



Characteristics current and voltage monitoring relays¹⁾

- Monitoring of DC and AC currents: 3 mA to 15 A
- Monitoring of DC and AC voltages from 3-600 V
- TRMS measuring principle
- One device includes 3 current measuring ranges
- One device includes 4 voltage measuring ranges: 3-30 V; 6-60 V; 30-300 V; 60-600 V
- Over- and undercurrent monitoring
- Over- and undervoltage monitoring
- ON or OFF-delay configurable
- Open- or closed-circuit principle configurable
- Threshold values for >U and/or <U adjustable
- Latching function configurable
- Thresholds for >I and/or <I adjustable
- Fixed hysteresis of 5 %
- Start-up delay T_v , adjustable 0; 0.1-30 s
- Tripping delay T_v , adjustable 0; 0.1-30 s
- 1 x 2 c/o contacts (common signal) or 2 x 1 c/o contact (separate signals for >I and <I) configurable
- 1 x 2 c/o contacts (common signal) or 2 x 1 c/o contact (separate signals for >U and <U) configurable
- 22.5 mm width
- 3 LEDs for the indication of operational states
- Various approvals and marks

¹⁾ depending on device



Applications

- Protection of electronic or electromechanical devices against over- and under voltage or over- and under current
- DC motor speed control
- Battery monitoring
- Monitoring of AC or DC supplies
- Monitoring of heating or lighting circuits



Current monitoring, single-phase

The ABB current monitoring relays CM-SRS.xx reliably monitor the occurrence of currents that exceed or fall below the selected threshold value. The functions overcurrent or undercurrent monitoring can be preselected. Single- and multifunction devices for the monitoring of direct or alternating currents from 3 mA to 15 A are available.

Current window monitoring (I_{min} , I_{max})

The window monitoring relay CM-SFS.2x is available if the application requires the simultaneous monitoring of over- and undercurrents.

Voltage monitoring, single-phase

The ABB voltage monitoring relays CM-SRS.xx are used to monitor direct and alternating voltages within a range of 3-600 V. Over- or undervoltage detection can be preselected.

Voltage window monitoring (U_{min} , U_{max})

For the simultaneous detection of over- and undervoltages, the window monitoring relay CM-EFS.2 can be used.

Single-phase monitoring relays

Operating controls

Current monitoring relays



Adjustment of the threshold value $>I$ for overcurrent



Adjustment of the tripping delay T_V

- 
- DIP switches**
- ON-delay
 - OFF-delay
 - Closed-circuit principle
 - Open-circuit principle
 - Latching function activated
 - Latching function not activated
 - 2x1 c/o (SPDT) contact
 - 1x2 c/o (SPDT) contacts

Adjustment of the threshold value $<I$ for undercurrent



Indication of operational states
 I: red LED – over- / under-current
 R: yellow LED – relay status
 U/T: green LED – control supply voltage/timing



Adjustment of the start-up delay T_S

Single-phase monitoring relays

Operating controls

Voltage monitoring relays

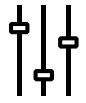

Adjustment of the threshold value $>U$ for overvoltage

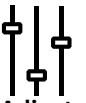

Adjustment of the tripping delay T_V



DIP switches

- ON-delay
- OFF-delay
- Closed-circuit principle
- Open-circuit principle
- Latching function activated
- Latching function not activated
- 2x1 c/o (SPDT) contact
- 1x2 c/o (SPDT) contacts

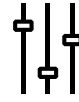

Adjustment of the threshold value $<U$ for undervoltage



Indication of operational states
 U: red LED – over- / under-voltage
 R: yellow LED – relay status
 U/T: green LED – control supply voltage/timing

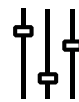

Adjustment of the measuring range

Single-phase current monitoring relays

Selection table

Type	Order number	CM-SRS.11S	1SVR730840R0200	CM-SRS.11P	1SVR740840R0200	CM-SRS.11S	1SVR730841R0200	CM-SRS.11P	1SVR740841R0200	CM-SRS.11S	1SVR730841R1200	CM-SRS.11P	1SVR740841R1200	CM-SRS.12S	1SVR730840R0300	CM-SRS.12S	1SVR730841R0300	CM-SRS.12S	1SVR730841R1300	CM-SRS.21S	1SVR730840R0400	CM-SRS.21P	1SVR740840R0400	CM-SRS.21S	1SVR730841R0400	CM-SRS.21P	1SVR740841R0400	CM-SRS.22S	1SVR730840R0500	CM-SRS.22S	1SVR730841R0500	CM-SRS.22S	1SVR730841R1500	CM-SRS.M1S	1SVR730840R0600	CM-SRS.M1P	1SVR740840R0600	CM-SRS.M2S	1SVR730840R0700	CM-SFS.21S	1SVR730760R0400	CM-SFS.21P	1SVR740760R0400	CM-SFS.22S	1SVR730760R0500											
Rated control supply voltage U_c																																																								
24 - 240 V AC/DC		■	■												■					■	■								■				■	■	■	■	■	■	■	■	■	■	■	■	■	■										
110 - 130 V AC				■	■											■						■	■								■																									
220 - 240 V AC											■	■							■											■	■																									
Measuring ranges AC/DC																																																								
3 - 30 mA		■	■	■	■	■	■														■	■	■	■	■	■																														
10 - 100 mA		■	■	■	■	■	■														■	■	■	■	■	■																														
0.1 - 1 A		■	■	■	■	■	■														■	■	■	■	■	■																														
0.3 - 1.5 A																																																								
1 - 5 A																																																								
3 - 15 A																																																								
Monitoring function																																																								
Over- or undercurrent		■	■	■	■	■	■	■	■	■	■	■	■	■	■	■	■	■	■	■	■	■	■	■	■	■	■	■	■	■	■	■	■	■	■	■	■	■	■	■	■	■	■	■	■	■	■	■	■	■	■	■				
Window current monitoring																																																								
Latching																																																								
Open-circuit or closed-circuit principle																																																								
Timing functions for tripping delay																																																								
ON-delay, 0.1 - 30 s																																																								
ON- or OFF-delay, 0.1 - 30 s																																																								
Output																																																								
c/o contact		1	1	1	1	1	1	1	1	1	1	1	1	1	1	1	1	1	1	1	2	2	2	2	2	2	2	2	2	2	2	2	2	2	2	2	2	2	2	2	2	2	2	2	2	2	2	2	2	2	2	2				
Connection type																																																								
Push-in terminals			■			■				■																																														
Double-chamber cage connection terminals		■			■					■					■																																									

adj: adjustable
sel: selectable

Single-phase current monitoring relays

Ordering details



CM-SRS.22S

2CDC 251 054 V0011



CM-SFS.22P

2CDC 251 056 V0011

Description

The CM range current monitoring relays protect single-phase mains (DC or AC) from over- and undercurrent from 3 mA to 15 A.

Ordering details

Description	Type	Order code	Weight (1 pc) kg (lb)
See selection table	CM-SRS.11S	1SVR730840R0200	0.145 (0.320)
		1SVR730841R0200	0.161 (0.355)
		1SVR730841R1200	0.161 (0.355)
	CM-SRS.11P	1SVR740840R0200	0.137 (0.302)
		1SVR740841R0200	0.153 (0.337)
		1SVR740841R1200	0.153 (0.337)
	CM-SRS.12S	1SVR730840R0300	0.137 (0.302)
		1SVR730841R0300	0.168 (0.370)
		1SVR730841R1300	0.168 (0.370)
	CM-SRS.21S	1SVR730840R0400	0.152 (0.335)
		1SVR730841R0400	0.179 (0.395)
		1SVR730841R1400	0.179 (0.395)
	CM-SRS.21P	1SVR740840R0400	0.141 (0.311)
		1SVR740841R0400	0.168 (0.370)
		1SVR740841R1400	0.168 (0.370)
	CM-SRS.22S	1SVR730840R0500	0.144 (0.399)
		1SVR730841R0500	0.181 (0.399)
		1SVR730841R1500	0.181 (0.399)
	CM-SRS.M1S	1SVR730840R0600	0.153 (0.337)
	CM-SRS.M1P	1SVR740840R0600	0.142 (0.313)
	CM-SRS.M2S	1SVR730840R0700	0.155 (0.342)
	CM-SFS.21S	1SVR730760R0400	0.150 (0.331)
	CM-SFS.21P	1SVR740760R0400	0.139 (0.306)
	CM-SFS.22S	1SVR730760R0500	0.158 (0.348)

S: screw connection
P: push-in connection

Single-phase voltage monitoring relays

Selection table

	Type	Order number															
	CM-ESS.1S	1SVR730830R0300															
	CM-ESS.1P	1SVR740830R0300															
	CM-ESS.1S	1SVR730831R0300															
	CM-ESS.1P	1SVR740831R0300															
	CM-ESS.1S	1SVR730831R1300															
	CM-ESS.1P	1SVR740831R1300															
	CM-ESS.2S	1SVR730830R0400															
	CM-ESS.2P	1SVR740830R0400															
	CM-ESS.2S	1SVR730831R0400															
	CM-ESS.2P	1SVR740831R0400															
	CM-ESS.2S	1SVR730831R1400															
	CM-ESS.2P	1SVR740831R1400															
	CM-ESS.MS	1SVR730830R0500															
	CM-ESS.MP	1SVR740830R0500															
	CM-EFS.2S	1SVR730750R0400															
	CM-EFS.2P	1SVR740750R0400															
Rated control supply voltage U_s																	
24 - 240 V AC/DC			■	■													
110 - 130 V AC					■	■											
220 - 240 V AC							■	■									
Measuring ranges AC/DC																	
3 - 30 V			■	■	■	■	■	■	■	■	■	■	■	■	■	■	■
6 - 60 V			■	■	■	■	■	■	■	■	■	■	■	■	■	■	■
30 - 300 V			■	■	■	■	■	■	■	■	■	■	■	■	■	■	■
60 - 600 V			■	■	■	■	■	■	■	■	■	■	■	■	■	■	■
Monitoring function																	
Over- or undervoltage			■	■	■	■	■	■	■	■	■	■	■	■	■	■	■
Windows voltage monitoring																	
Latching															sel	sel	sel
Open-circuit or closed-circuit principle															sel	sel	sel
Timing functions for tripping delay																	
ON-delay, 0.1 - 30 s										adj	adj	adj	adj	adj	adj	adj	
ON- or OFF-delay, 0.1 - 30 s																	sel
Output																	
c/o contact			1	1	1	1	1	1	1	2	2	2	2	2	2	2	2
Connection type																	
Push-in terminals			■		■		■		■		■		■		■		■
Double-chamber cage connection terminals			■		■		■		■		■		■		■		■

adj: adjustable
sel: selectable

Single-phase voltage monitoring relays

Ordering details



2CDC251 060 V0011

CM-ESS.MP



2CDC251 059 V0011

CM-EFS.2

Description

The CM range voltage monitoring relays provide reliable monitoring of voltages, as well as the detection of phase loss in single-phase mains.









Ordering details

Description	Type	Order code	Weight (1 pc) kg (lb)
See selection table	CM-ESS.1S	1SVR730830R0300	0.135 (0.298)
		1SVR730831R0300	0.164 (0.362)
		1SVR730831R1300	0.164 (0.362)
	CM-ESS.1P	1SVR740830R0300	0.126 (0.278)
		1SVR740831R0300	0.155 (0.342)
		1SVR740831R1300	0.155 (0.342)
	CM-ESS.2S	1SVR730830R0400	0.153 (0.337)
		1SVR730831R0400	0.181 (0.399)
		1SVR730831R1400	0.181 (0.399)
	CM-ESS.2P	1SVR740830R0400	0.142 (0.313)
		1SVR740831R0400	0.170 (0.375)
		1SVR740831R1400	0.170 (0.375)
	CM-ESS.MS	1SVR730830R0500	0.154 (0.340)
	CM-ESS.MP	1SVR740830R0500	0.143 (0.320)
	CM-EFS.2S	1SVR730750R0400	0.157 (0.346)
CM-EFS.2P	1SVR740750R0400	0.146 (0.322)	

S: screw connection
P: push-in connection

Single-phase current monitoring relays

Technical data

Type	CM-SRS.1	CM-SRS.2	CM-SRS.M	CM-SFS.2			
Input circuit - Supply circuit		A1-A2					
Rated control supply voltage U_s	A1-A2	110-130 V AC					
	A1-A2	220-240 V AC					
	A1-A2	24-240 V AC/DC					
Rated control supply voltage U_s tolerance		-15...+10 %					
Rated frequency	AC versions	50/60 Hz					
	AC/DC versions	50/60 Hz or DC					
Current / power consumption		see data sheets					
Power failure buffering time		20 ms					
Transient overvoltage protection		Varistors					
Input circuit - Measuring circuit		B1/B2/B3-C					
Monitoring function		over- or undercurrent monitoring configurable		over- and under-current monitoring			
Measuring method		True RMS measuring principle					
Measuring inputs		CM-SxS.x1			CM-SxS.x2		
	Terminal connection	B1-C	B2-C	B3-C	B1-C	B2-C	B3-C
	Measuring ranges AC/DC	3-30 mA	10-100 mA	0.1-1 A	0.3-1.5 A	1-5 A	3-15 A ¹⁾
	Input resistance	3.3 Ω	1 Ω	0.1 Ω	0.05 Ω	0.01 Ω	0.0025 Ω
	Pulse overload capacity $t < 1$ s	500 mA	1 A	10 A	15 A	50 A	100 A
	Continuous capacity	50 mA	150 mA	1.5 A	2 A	7 A	17 A
	Threshold value(s)		adjustable within the indicated measuring range				
Setting accuracy of threshold value		6 % of full-scale value					
Hysteresis related to the threshold value		3-30 % adjustable				5 % fixed	
Measuring signal frequency range		DC / 15 Hz - 2 kHz					
Rated measuring signal frequency range		DC / 50-60 Hz					
Maximum response time		AC: 80 ms / DC: 120 ms					
Accuracy within the control supply voltage tolerance		$\Delta U \leq 0.5$ %					
Accuracy within the temperature range		$\Delta U \leq 0.06$ % / °C					
Timing circuit							
Start-up delay T_s		none	0 or 0.1-30 s adjustable				
Tripping delay T_v		none	0 or 0.1-30 s adjustable				
Repeat accuracy (constant parameters)		± 0.07 % of full scale					
Accuracy within the control supply voltage tolerance		-	$\Delta t \leq 0.5$ %				
Accuracy within the temperature range		-	$\Delta t \leq 0.06$ % / °C				
Indication of operational states							
Control supply voltage	U/T: green LED	 : control supply voltage applied,  : start-up delay T_s active,  : tripping delay T_v active					
Measured value	I: red LED	 : overcurrent,  : undercurrent					
Relay status	R: yellow LED	 : relay energized, no latching function  : relay energized, active latching function  : relay de-energized, active latching function					

Single-phase current monitoring relays

Technical data

Type	CM-SRS.1	CM-SRS.2	CM-SRS.M	CM-SFS.2
Output circuits	11(15)-12(16)/14(18), 21(25)-22(26)/24(28) - Relays			
Kind of output	1 c/o contact	2 c/o contacts		1x2 c/o contacts or 2x1 c/o contact configurable
Operating principle	open-circuit principle ²⁾		open- or closed-circuit principle configurable ²⁾	
Contact material	AgNi			
Minimum switching voltage / minimum switching current	24 V / 10 mA			
Maximum switching voltage / maximum switching current	250 V AC / 4 A AC			
Rated operational voltage U _e and rated operational current I _e	AC-12 (resistive) at 230 V	4 A		
	AC-15 (inductive) at 230 V	3 A		
	DC-12 (resistive) at 24 V	4 A		
	DC-13 (inductive) at 24 V	2 A		
AC rating (UL 508)	Utilization category (Control Circuit Rating Code)	B 300		
	max. rated operational voltage	300 V AC		
	max. continuous thermal current at B 300	5 A		
	max. making/breaking apparent power (Make/Break) at B 300	3600/360 VA		
Mechanical lifetime	30x10 ⁶ switching cycles			
Electrical lifetime (AC-12, 230 V, 4 A)	0.1x10 ⁶ switching cycles			
Max. fuse rating to achieve short-circuit protection	n/c contact	6 A fast-acting	10 A fast-acting	6 A fast-acting
	n/o contact	10 A fast-acting		

¹⁾ In case of measured currents > 10 A, lateral spacing has to be min. 10 mm

²⁾ Open-circuit principle: output relay energizes if the measured value exceeds \square / falls below \square the adjusted threshold value
 Closed-circuit principle: output relay de-energizes if measured value exceeds \square / falls below \square the adjusted threshold value







Single-phase current monitoring relays

Technical data

Type	CM-SRS.1	CM-SRS.2	CM-SRS.M	CM-SFS.2
General data				
MTBF	on request			
Duty cycle	100 %			
Dimensions	see dimensional drawings			
Mounting	DIN rail (IEC/EN 60715), snap-on mounting without any tool			
Mounting position	any			
Minimum distance to other units	10 mm (0.39 in) at measured current > 10 A			
Material of housing	UL 94 V-0			
Degree of protection	housing / terminals	IP50 / IP20		
Electrical connection				
Connecting capacity	fine-strand with(out) wire end ferrule	Screw connection technology		Easy Connect Technology (Push-in)
		1 x 0.5-2.5 mm ² (1 x 20-14 AWG)		2 x 0.5-1.5 mm ² (2 x 20-16 AWG)
		2 x 0.5-1.5 mm ² (2 x 20-16 AWG)		
	rigid	1 x 0.5-4 mm ² (1 x 20-12 AWG)		2 x 0.5-1.5 mm ² (2 x 20-16 AWG)
		2 x 0.5-2.5 mm ² (2 x 20-14 AWG)		
Stripping length	8 mm (0.32 in)			
Tightening torque	0.6-0.8 Nm (7.08 lb.in)			-
Environmental data				
Ambient temperature range	operation / storage	-20...+60 °C / -40...+85 °C		
Damp heat (IEC 60068-2-30)	55 °C, 6 cycles			
Vibration (sinusoidal)	class 2			
Shock	class 2			
Isolation data				
Rated insulation voltage	supply / measuring circuit / output	600 V		
	supply / output 1/2	250 V		
Rated impulse withstand voltage U _{imp}	supply / measuring circuit / output	6 kV 1.2/50 μs		
	supply / output 1/2	4 kV 1.2/50 μs		
Pollution degree	3			
Overvoltage category	III			
Standards / Directives				
Standards	IEC/EN 60255-27, IEC/EN 60947-5-1			
Low Voltage Directive	2014/35/EU			
EMC Directive	2014/30/EU			
RoHS Directive	2011/65/EU			
Electromagnetic compatibility				
Interference immunity to	IEC/EN 61000-6-2			
electrostatic discharge	IEC/EN 61000-4-2	level 3		
radiated, radio-frequency, electromagnetic field	IEC/EN 61000-4-3	level 3		
electrical fast transient / burst	IEC/EN 61000-4-4	level 3		
surge	IEC/EN 61000-4-5	level 3		
conducted disturbances, induced by radio-frequency fields	IEC/EN 61000-4-6	level 3		
Interference emission	IEC/EN 61000-6-3			
high-frequency radiated	IEC/CISPR 22; EN 55022	Class B		
high-frequency conducted	IEC/CISPR 22; EN 55022	Class B		

Single-phase voltage monitoring relays

Technical data

Type	CM-ESS.1	CM-ESS.2	CM-ESS.M	CM-EFS.2	
Input circuit - Supply circuit		A1-A2			
Rated control supply voltage U_s	A1-A2	110-130 V AC			
	A1-A2	220-240 V AC			
	A1-A2	24-240 V AC/DC			
Rated control supply voltage U_s tolerance		-15...+10 %			
Rated frequency	AC versions	50/60 Hz			
	AC/DC versions	50/60 Hz or DC			
Current / power consumption		see data sheet			
Power failure buffering time		20 ms			
Transient overvoltage protection		varistors			
Input circuit - Measuring circuit		B-C			
Monitoring function		over- or undervoltage monitoring configurable		over- and under-voltage monitoring configurable	
Measuring method		True RMS measuring principle			
Measuring inputs	CM-ExS				
	Terminal connection	B-C	B-C	B-C	B-C
	Measuring range AC/DC	3-30 V	6-60 V	30-300 V	60-600 V
	Input resistance	600 k Ω	600 k Ω	600 k Ω	600 k Ω
	Pulse overload capacity $t < 1$ s	800 V	800 V	800 V	800 V
Continuous capacity	660 V	660 V	660 V	660 V	
Threshold value(s)		adjustable within the indicated measuring range			
Tolerance of the adjusted threshold value		6 % of full-scale value			
Hysteresis related to the threshold value		3-30 % adjustable		5 % fixed	
Measuring signal frequency range		DC / 15 Hz - 2 kHz			
Rated measuring signal frequency range		DC / 50-60 Hz			
Maximum response time		AC: 80 ms / DC: 120 ms			
Accuracy within the control supply voltage tolerance		$\Delta U \leq 0.5$ %			
Accuracy within the temperature range		$\Delta U \leq 0.06$ % / $^{\circ}\text{C}$			
Transient overvoltage protection		Varistors			
Timing circuit					
Delay time T_v		none	0 or 0.1-30 s adjustable		
Repeat accuracy (constant parameters)		± 0.07 % of full scale value			
Accuracy within the control supply voltage tolerance		-	$\Delta t \leq 0.5$ %		
Accuracy within the temperature range		-	$\Delta t \leq 0.06$ % / $^{\circ}\text{C}$		
Indication of operational states					
Control supply voltage	U/T: green LED	 : control supply voltage applied  : tripping delay T_v active			
Measured value	U: red LED	 : overvoltage,  : undervoltage			
Relay status	R: yellow LED	 : relay energized, no latching function  : relay energized, active latching function  : relay de-energized, active latching function			

Single-phase voltage monitoring relays

Technical data

Type	CM-ESS.1	CM-ESS.2	CM-ESS.M	CM-EFS.2
Output circuits				
Kind of output	1 c/o contact	2 c/o contacts		1x2 c/o contacts or 2x1 c/o contact configurable
Operating principle	open-circuit principle ¹⁾		open- or closed-circuit principle configurable ¹⁾	
Contact material	AgNi			
Minimum switching voltage / minimum switching current	24 V / 10 mA			
Maximum switching voltage / maximum switching current	250 V AC / 4 A AC			
Rated operational voltage U _e and rated operational current I _e	AC-12 (resistive) at 230 V	4 A		
	AC-15 (inductive) at 230 V	3 A		
	DC-12 (resistive) at 24 V	4 A		
	DC-13 (inductive) at 24 V	2 A		
AC rating (UL 508)	Utilization category (Control Circuit Rating Code)	B 300		
	max. rated operational voltage	300 V AC		
	max. continuous thermal current at B 300	5 A		
	max. making/breaking apparent power (Make/Break) at B 300	3600/360 VA		
Mechanical lifetime	30x10 ⁶ switching cycles			
Electrical lifetime	AC-12, 230 V, 4 A	0.1x10 ⁶ switching cycles		
Max. fuse rating to achieve short-circuit protection	n/c contact	6 A fast-acting	10 A fast-acting	6 A fast-acting
	n/o contact	10 A fast-acting		

Single-phase voltage monitoring relays

Technical data

Type	CM-ESS.1	CM-ESS.2	CM-ESS.M	CM-EFS.2
General data				
MTBF	on request			
Duty cycle	100%			
Dimensions	see dimensional drawings			
Mounting	DIN rail (IEC/EN 60715), snap-on mounting without any tool			
Mounting position	any			
Minimum distance to other units	vertical / horizontal	not necessary / not necessary		
Material of housing	UL 94 V-0			
Degree of protection	housing / terminals	IP50 / IP20		
Environmental data				
Ambient temperature ranges	operation	-20...+60 °C		
	storage	-40...+85 °C		
Damp heat, cyclic (IEC/EN 60068-2-30)	55 °C, 6 cycle			
Vibration, sinusoidal	class 2			
Shock	class 2			
Electrical connection				
Wire size		Screw connection technology	Easy Connect Technology (Push-in)	
	fine-strand with(out) wire end ferrule	1 x 0.5-2.5 mm ² (1 x 18-14 AWG) 2 x 0.5-1.5 mm ² (2 x 18-16 AWG)	2 x 0.5-1.5 mm ² (2 x 18-16 AWG)	
	rigid	1 x 0.5-4 mm ² (1 x 20-12 AWG) 2 x 0.5-2.5 mm ² (2 x 20-14 AWG)	2 x 0.5-1.5 mm ² (2 x 20-16 AWG)	
Stripping length	8 mm (0.32 in)			
Tightening torque	0.6-0.8 Nm (7.08 lb.in)		-	
Isolation data				
Rated insulation voltage	supply / measuring circuit / output	600 V		
	supply / output 1/2	250 V		
Rated impulse withstand voltage U _{imp}	supply / measuring circuit / output	6 kV 1.2/50 μs		
	supply / output 1/2	4 kV 1.2/50 μs		
Pollution degree	3			
Overvoltage category	III			
Standards / Directives				
Product standard	IEC/EN 60255-27, IEC/EN 60947-5-1			
Low Voltage Directive	2014/35/EU			
EMC Directive	2014/30/EU			
RoHS Directive	2011/65/EU			
Electromagnetic compatibility				
Interference immunity to	IEC/EN 61000-6-2			
electrostatic discharge	IEC/EN 61000-4-2	level 3		
radiated, radio-frequency, electromagnetic field	IEC/EN 61000-4-3	level 3		
electrical fast transient / burst	IEC/EN 61000-4-4	level 3		
surge	IEC/EN 61000-4-5	level 3		
conducted disturbances, induced by radio-frequency fields	IEC/EN 61000-4-6	level 3		
Interference emission	IEC/EN 61000-6-3			
high-frequency radiated	IEC/CISPR 22; EN 55022	class B		
high-frequency conducted	IEC/CISPR 22; EN 55022	class B		

1) Open-circuit principle: output relay energizes if the measured value exceeds \geq / falls below \leq the adjusted threshold value
 Closed-circuit principle: output relay de-energizes if measured value exceeds \geq / falls below \leq the adjusted threshold value

Single-phase current monitoring relays

Technical diagrams

Connection diagram

CM-SRS.1x, CM-SRS.2x

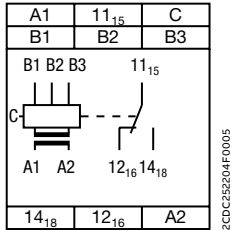

2CDC3204F0005

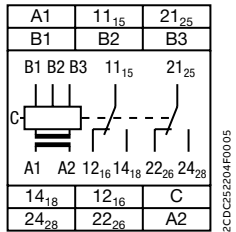

2CDC3204F0005

- A1-A2 Control supply voltage
- B1-C Measuring range 1: 3-30 mA or 0.3-1.5 A
- B2-C Measuring range 2: 10-100 mA or 1-5 A
- B3-C Measuring range 3: 0.1-1 A or 3-15 A
- 11₁₅-12₁₆/14₁₈ / 21₂₅-22₂₆/24₂₈ Output contacts - open-circuit principle

CM-SRS.Mx

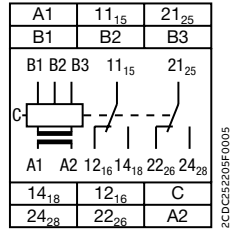

2CDC3205F0005

- A1-A2 Control supply voltage
- B1-C Measuring range 1: 3-30 mA or 0.3-1.5 A
- B2-C Measuring range 2: 10-100 mA or 1-5 A
- B3-C Measuring range 3: 0.1-1 A or 3-15 A
- 11₁₅-12₁₆/14₁₈ / 21₂₅-22₂₆/24₂₈ Output contacts - open- or closed circuit principle

CM-SFS.2x

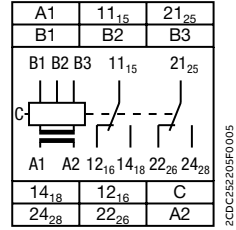

2CDC32205F0005

- A1-A2 Control supply voltage
- B1-C Measuring range 1: 3-30 mA or 0.3-1.5 A
- B2-C Measuring range 2: 10-100 mA or 1-5 A
- B3-C Measuring range 3: 0.1-1 A or 3-15 A
- 11₁₅-12₁₆/14₁₈ / 21₂₅-22₂₆/24₂₈ Output contacts - open- or closed circuit principle

CM-SRS.2x

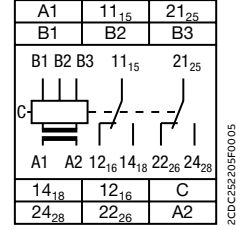

2CDC32205F0005

- A1-A2 Control supply voltage
- B1-C Measuring range 1: 3-30 mA or 0.3-1.5 A
- B2-C Measuring range 2: 10-100 mA or 1-5 A
- B3-C Measuring range 3: 0.1-1 A or 3-15 A
- 11₁₅-12₁₆/14₁₈ / 21₂₅-22₂₆/24₂₈ Output contacts - open- or closed circuit principle

DIP switch functions

CM-SRS.1x, CM-SRS.2x

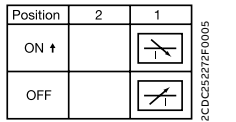

2CDC252272F0005

- 1 ON Undercurrent monitoring
 - 1 OFF Overcurrent monitoring
- OFF = Default

CM-SRS.Mx

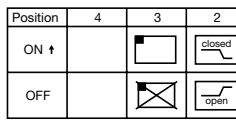

2CDC252273F0005

- 1 ON Undercurrent monitoring
 - 1 OFF Overcurrent monitoring
 - 2 ON Closed-circuit principle
 - 2 OFF Open-circuit principle
 - 3 ON Latching function activated
 - 3 OFF Latching function not activated
- OFF = Default

CM-SFS.2x

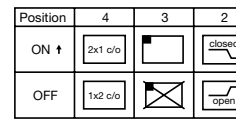

2CDC252274F0005

- 1 ON OFF-delay
 - 1 OFF ON-delay
 - 2 ON Closed-circuit principle
 - 2 OFF Open-circuit principle
 - 3 ON Latching function activated
 - 3 OFF Latching function not activated
 - 4 ON 2x1 c/o contact
 - 4 OFF 1x2 c/o contacts
- OFF = Default

CM-SRS.2x

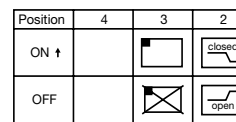

2CDC252273F0005

- 1 ON Undercurrent monitoring
 - 1 OFF Overcurrent monitoring
 - 2 ON Closed-circuit principle
 - 2 OFF Open-circuit principle
 - 3 ON Latching function activated
 - 3 OFF Latching function not activated
- OFF = Default

Single-phase voltage monitoring relays

Technical diagrams

Connection diagram

CM-ESS.1, CM-ESS.2

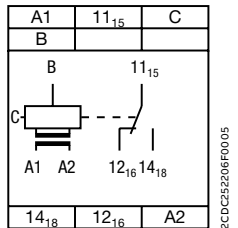

2CDC252206F0005

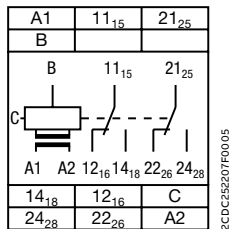

2CDC252207F0005

A1-A2	Control supply voltage
B-C	Measuring ranges AC/DC: 3-30 V; 6-60 V; 30-300 V; 60-600 V
11 ₁₅ -12 ₁₆ /14 ₁₈ 21 ₂₅ -22 ₂₆ /24 ₂₈	Output contacts - open-circuit principle

CM-EFS.2

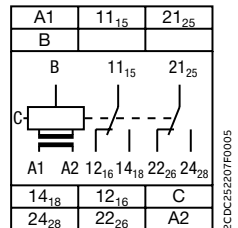

2CDC252207F0005

A1-A2	Control supply voltage
B-C	Measuring ranges AC/DC: 3-30 V; 6-60 V; 30-300 V; 60-600 V
11 ₁₅ -12 ₁₆ /14 ₁₈ 21 ₂₅ -22 ₂₆ /24 ₂₈	Output contacts - open- or closed circuit principle

CM-ESS.M

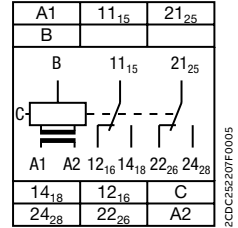

2CDC252207F0005

A1-A2	Control supply voltage
B-C	Measuring ranges AC/DC: 3-30 V; 6-60 V; 30-300 V; 60-600 V
11 ₁₅ -12 ₁₆ /14 ₁₈ 21 ₂₅ -22 ₂₆ /24 ₂₈	Output contacts - open- or closed circuit principle

DIP switch functions

CM-ESS.1, CM-ESS.2

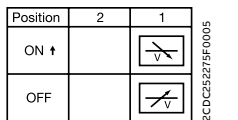

2CDC252276F0005

1	ON	Undervoltage monitoring
	OFF	Overvoltage monitoring
OFF = Default		

CM-EFS.2

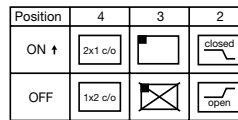

2CDC252274F0005

1	ON	ON-delay
	OFF	OFF-delay
2	ON	Closed-circuit principle
	OFF	Open-circuit principle
3	ON	Latching function activated
	OFF	Latching function not activated
4	ON	2x1 c/o contact
	OFF	1x2 c/o contacts
OFF = Default		

CM-ESS.M

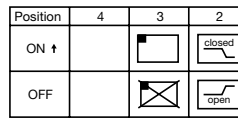

2CDC252276F0005

1	ON	Undervoltage monitoring
	OFF	Overvoltage monitoring
2	ON	Closed-circuit principle
	OFF	Open-circuit principle
3	ON	Latching function activated
	OFF	Latching function not activated
OFF = Default		

Single-phase monitoring relays

Function diagrams

CM-SRS.1x and CM-SRS.2x

If the measured value exceeds resp. drops below the adjusted threshold value, the output relay(s) energize(s): on the CM-SRS.1x - immediately, on the CM-SRS.2x - after the set tripping delay T_v . If the measured value exceeds resp. drops below the threshold value plus resp. minus the adjusted hysteresis, the output relay(s) de-energize(s). The hysteresis is adjustable within a range of 3-30 % of the threshold value.

CM-SRS.1x

Overcurrent monitoring

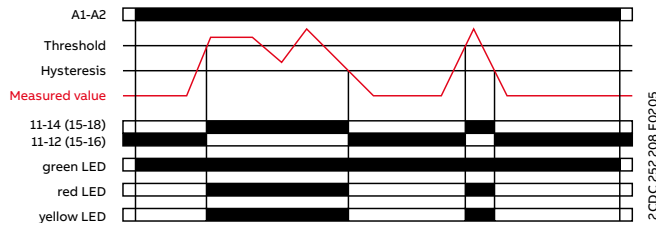

Undercurrent monitoring

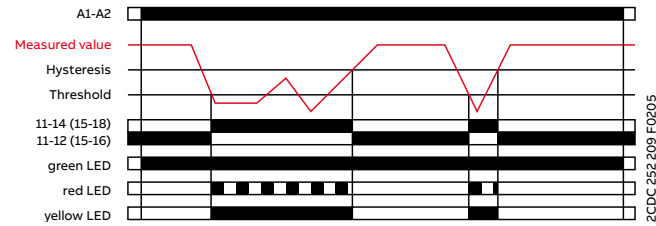

CM-SRS.2x

Overcurrent monitoring

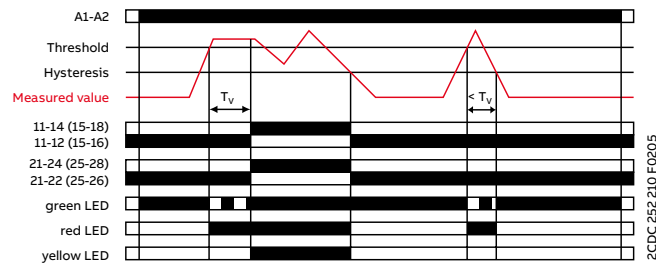

Undercurrent monitoring

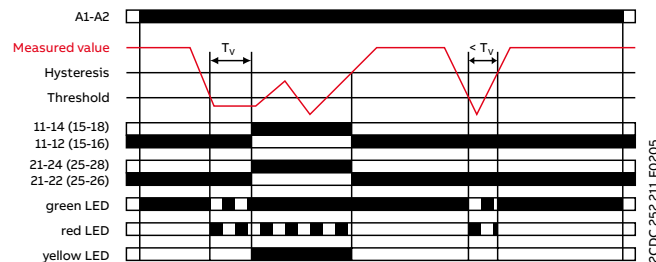

Single-phase monitoring relays

Function diagrams

CM-SRS.Mx

If the measured value exceeds resp. drops below the adjusted threshold value before the set start-up delay T_s is complete, the output relays do not change their actual state. If the measured value exceeds resp. drops below the adjusted threshold value when T_s is complete, the tripping delay T_v starts. If T_v is complete and the measured value is still exceeding resp. below the threshold value plus resp. minus the set hysteresis, the output relays energize / de-energize.

If the measured value exceeds resp. drops below the threshold value minus resp. plus the set hysteresis and the latching function is not activated, the output relays de-energize / energize. With activated latching function the output relays remain energized and de-energize only when the supply voltage is interrupted / the output relays remain de-energized and energize only when the supply voltage is switched off and then again switched on = Reset. The hysteresis is adjustable within a range of 3-30 % of the threshold value.

Overcurrent monitoring with latching

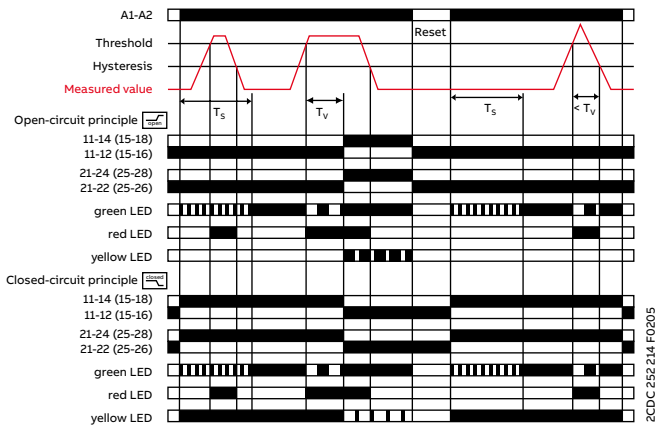

Overcurrent monitoring without latching

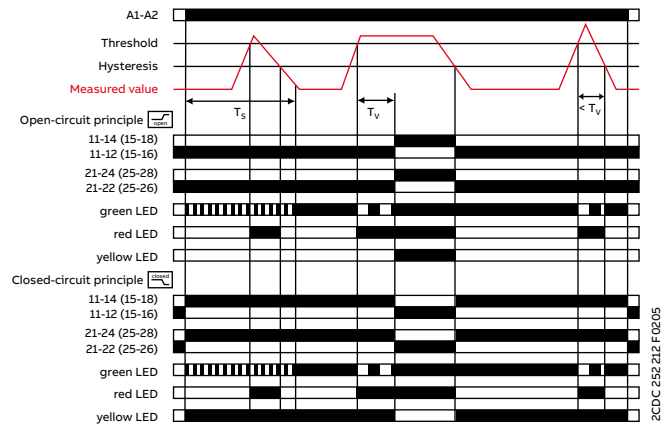

Undercurrent monitoring with latching

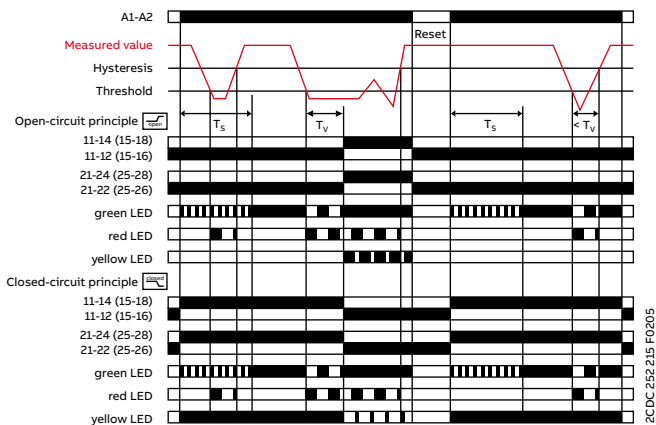

Undercurrent monitoring without latching

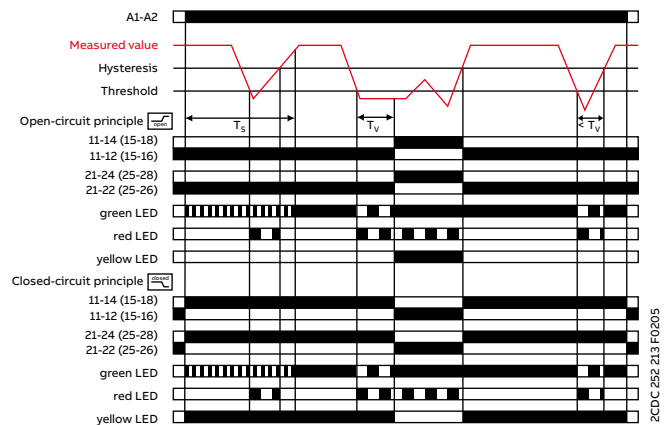

Single-phase monitoring relays

Function diagrams

CM-SFS.2x

Current window monitoring 1x2 c/o contact

ON-delayed without latching

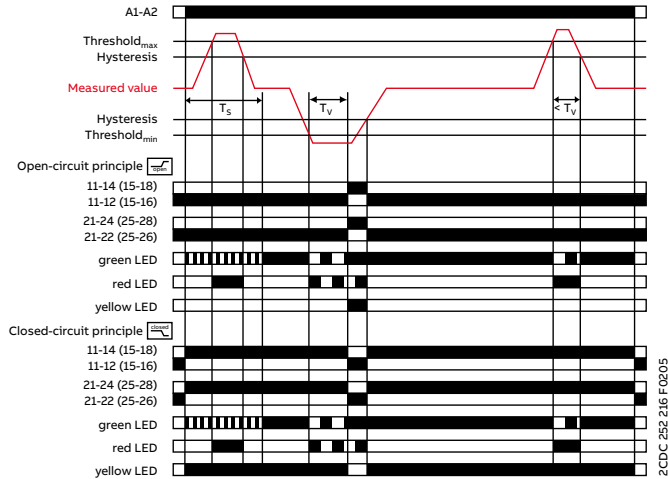

2CDC 252 216 F 02/05

ON-delayed current window monitoring with parallel switching c/o contacts :

If the measured value exceeds resp. drops below the adjusted threshold value before the set start-up delay T_s is complete, the output relays do not change their actual state.

If the measured value exceeds resp. drops below the adjusted threshold value when T_s is complete, the tripping delay T_v starts when is configured. If T_v is complete and the measured value is still exceeding resp. below the threshold value minus resp. plus the fixed hysteresis (5%), the output relays energize /de-energize .

If the measured value exceeds resp. drops below the threshold value plus resp. minus the hysteresis and the latching function is not activated , the output relays de-energize / energize . With activated latching function the output relays remain energized and de-energize only when the supply voltage is interrupted / the output relays remain de-energized and energize only when the supply voltage is switched off and then again switched on = Reset.

Current window monitoring 1x2 c/o contact

OFF-delayed without latching

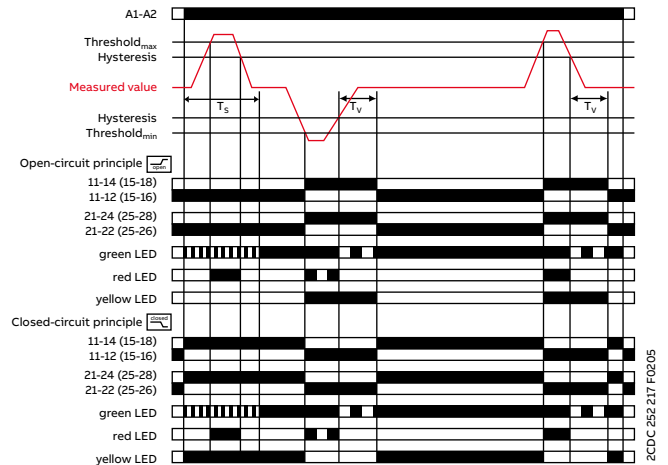

2CDC 252 217 F 02/05

OFF-delayed current window monitoring with parallel switching c/o contacts :



If the measured value exceeds resp. drops below the adjusted threshold value when the set start-up delay T_s is complete, the output relays energize / de-energize , when is configured, and remain in this position during the set tripping delay T_v . If the measured value exceeds resp. drops below the threshold value plus resp. minus the fixed hysteresis (5%) and the latching function is not activated , the tripping delay T_v starts. After completion of T_v , the output relays de-energize / energize , provided that the latching function is not activated . With activated latching function the output relays remain energized and de-energize only when the supply voltage is interrupted / the output relays remain de-energized and energize only when the supply voltage is switched off and then again switched on = Reset. When is adjusted on the device, the functionality is equivalent to the one described above. In this case, instead of both output relays, only one output relay each will be switched.

">I" = 11₁₅-12₁₆/14₁₈ ; "<I" = 21₂₅-22₂₆/24₂₈

Single-phase monitoring relays

Function diagrams

CM-ESS.1x and CM-ESS.2x

Depending on the configuration, the voltage monitoring relays CM-ESS.1 and CM-ESS.2 can be used for over- or under- voltage monitoring in single-phase AC and/or DC systems. The voltage to be monitored (measured value) is applied to terminals B-C. The devices work according to the open-circuit principle. If the measured value exceeds resp. drops below the adjusted threshold value, the output relay(s) energize(s): on the CM-ESS.1 - immediately, on the CM-ESS.2 - after the set tripping delay T_v . If the measured value exceeds resp. drops below the threshold value plus resp. minus the adjusted hysteresis, the output relay(s) de-energize(s). The hysteresis is adjustable within a range of 3-30 % of the threshold value.

CM-ESS.1x

Overvoltage monitoring

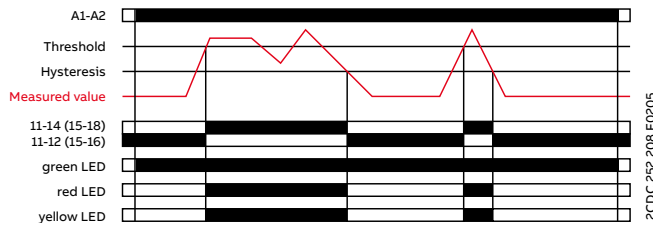

Undervoltage monitoring

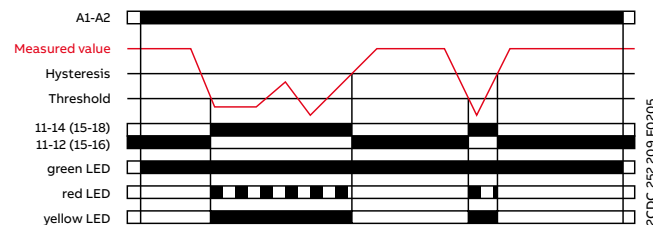

CM-ESS.2x

Overvoltage monitoring

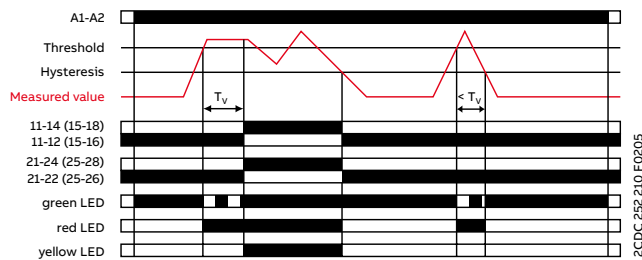

Undervoltage monitoring

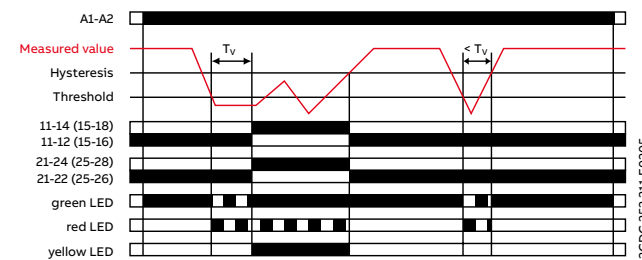

Single-phase monitoring relays

Function diagrams

CM-ESS.Mx

If the measured value exceeds resp. drops below the adjusted threshold value, the tripping delay T_V starts. If T_V is complete and the measured value is still exceeding resp. below the threshold value plus resp. minus the set hysteresis, the output relays energize / de-energize.

If the measured value exceeds resp. drops below the threshold value plus resp. minus the set hysteresis and the latching function is not activated, the output relays de-energize / energize. With activated latching function the output relays remain energized and de-energize only when the supply voltage is interrupted / the output relays remain de-energized and energize only when the supply voltage is switched off and then again switched on = Reset. The hysteresis is adjustable within a range of 3-30 % of the threshold value.

Overvoltage monitoring without latching

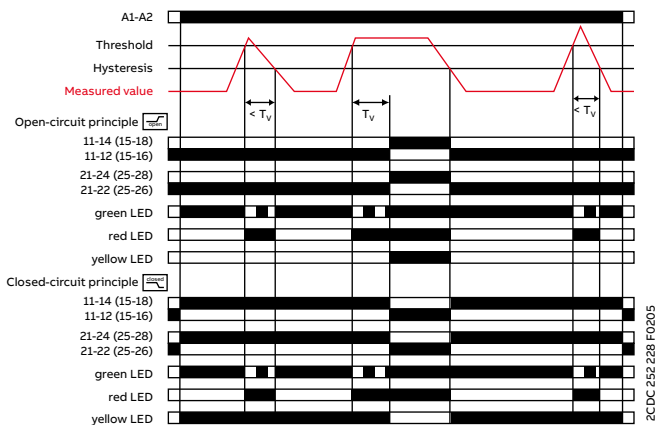

Overvoltage monitoring with latching

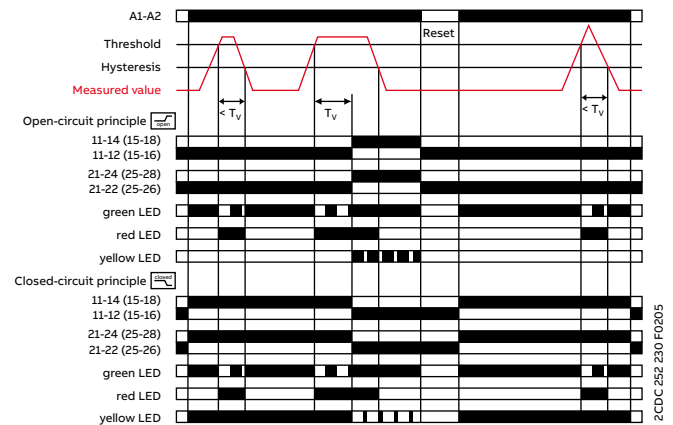

Undervoltage monitoring without latching

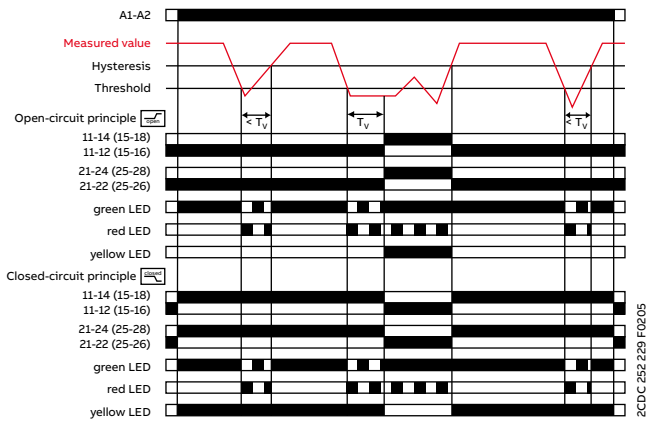

Undervoltage monitoring with latching

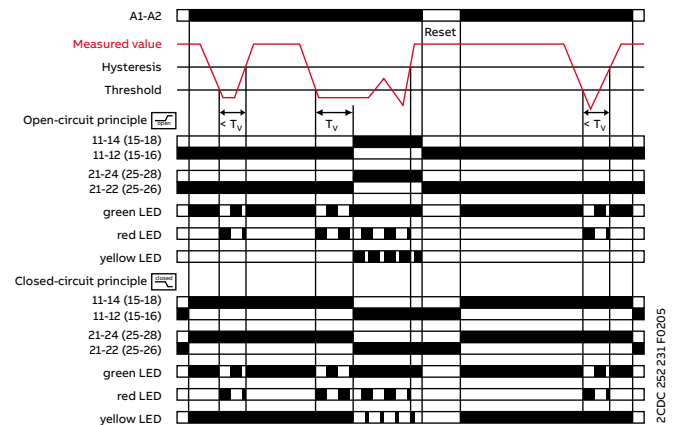

Single-phase monitoring relays

Function diagrams

CM-EFS.2x

Voltage window monitoring 1x2 c/o contact [1x2 c/o]
 ON-delayed [ON-Delayed] without latching [No Latching]

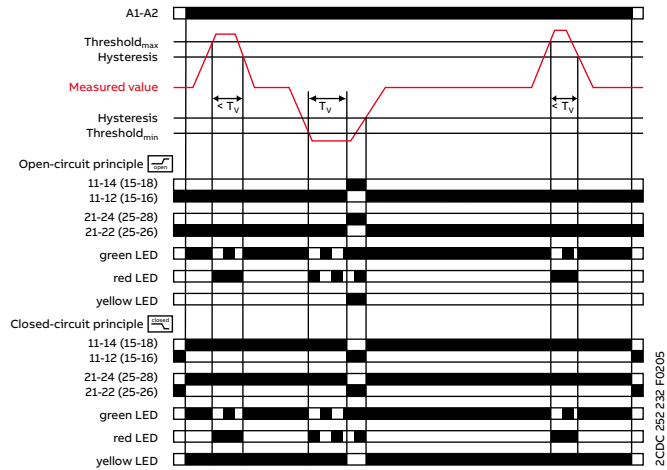

ON-delayed [ON-Delayed] voltage window monitoring with parallel switching c/o contacts [1x2 c/o]:

If the measured value exceeds resp. drops below the adjusted threshold value, the tripping delay T_v starts, when [ON-Delayed] is configured. If T_v is complete and the measured value is still exceeding resp. below the threshold value minus resp. plus the fixed hysteresis (5%), the output relays energize [ON-Delayed] / de-energize [ON-Delayed].

If the measured value exceeds resp. drops below the threshold value plus resp. minus the hysteresis and the latching function is not activated [No Latching], the output relays de-energize [ON-Delayed] / energize [ON-Delayed]. With activated latching function [Latching] the output relays remain energized [ON-Delayed] and de-energize only when the supply voltage is interrupted / the output relays remain de-energized [ON-Delayed] and energize only when the supply voltage is switched off and then again switched on = Reset.

Voltage window monitoring 1x2 c/o contact [1x2 c/o]
 OFF-delayed [OFF-Delayed] without latching [No Latching]

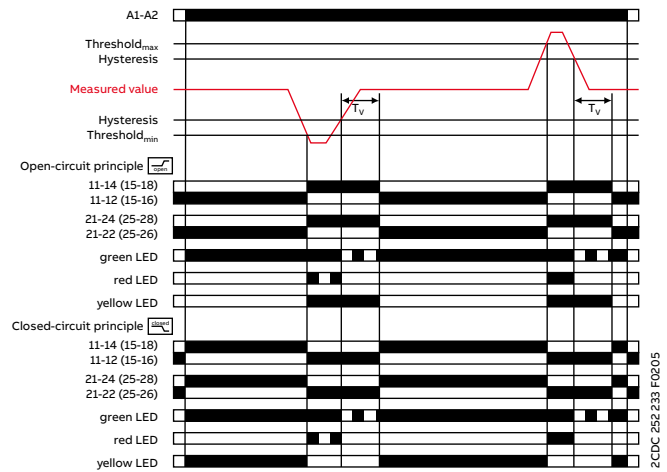

OFF-delayed [OFF-Delayed] voltage window monitoring with parallel switching c/o contacts [1x2 c/o]:

If the measured value exceeds resp. drops below the adjusted threshold value, the output relays energize [OFF-Delayed] / de-energize [OFF-Delayed], when [OFF-Delayed] is configured, and remain in this position during the set tripping delay T_v .

If the measured value exceeds resp. drops below the threshold value plus resp. minus the fixed hysteresis (5%) and the latching function is not activated [No Latching], the tripping delay T_v starts.

After completion of T_v , the output relays de-energize [OFF-Delayed] / energize [OFF-Delayed], provided that the latching function is not activated [No Latching]. With activated latching function [Latching] the output relays remain energized [OFF-Delayed] and de-energize only when the supply voltage is interrupted / the output relays remain de-energized [OFF-Delayed] and energize only when the supply voltage is switched off and then again switched on = Reset. When [2x1 c/o] is adjusted on the device, the functionality is equivalent to the one described above. In this case, instead of both output relays, only one output relay each will be switched.

$$">U" = 11_{15}-12_{16}/14_{18}; "<U" = 21_{25}-22_{26}/24_{28}$$



Three-phase monitoring relays

Table of contents

106	Benefits and advantages
109	Function
110	Operating controls
112	Selection table - singlefunctional
113	Ordering details - singlefunctional
114	Selection table - multifunctional
115	Ordering details - multifunctional
116	Technical data
127	Technical diagrams
129	Function diagrams

Three-phase monitoring relays

Benefits and advantages



For the monitoring of voltages in a three-phase system or network, ABB's CM range contains a wide selection of powerful and compact devices. This product range includes voltage monitoring relays for phase sequence, phase loss, unbalance and monitoring of over- and under voltage from 160 V to 820 V.



Continuous operation

Read the status of the relay at a glance: clear visualization of the device status via LEDs. Easy to adjust with rotary wheels and variants with push-in terminals make a quick and easy installation and setting possible.



Reliable in harsh conditions

All relays work reliably in environments with low temperatures down to -25°C . Additionally, the housing fulfills the UL 94 V-0 flammability standard requirements. Together with the vibration resistant push-in terminals, the relay is not only reliable no matter the environment temperature but is also durable to shock and vibration. Save time as retightening is no longer needed and enhance the reliability and safety not only for the equipment.



Easy installation

Like all devices from the measuring and monitoring portfolio, the three-phase monitoring relays are easily configurable via front facing potentiometers. Easy threshold configuration without calculation is accomplished by direct reading scales. For further configuration options, additional settings can be made via dip-switches, offering the flexibility to configure, for example, the working principle of the relays and the output configuration. The device can be set up before installation in the application and easy adjustments during the process are possible.

Three-phase monitoring relays

Benefits and advantages



Characteristics

- True RMS (TRMS) measuring principle
- Device for the use in mains with a frequency of 45-440 Hz and where harmonics are to be expected⁽¹⁾
- Adjustable phase unbalance threshold value
- Adjustable ON-delay/OFF-delay time
- Powered by the measuring circuit
- 1 n/o contact, 1 or 2 c/o contacts
- LEDs for the indication of operational states
- Multifunctional and singlefunctional devices
- Phase failure detection
- Phase sequence monitoring
- Over- and undervoltage monitoring (fixed or adjustable)
- Wide-range operating voltage guarantees world-wide operation
- Various approvals and marks

⁽¹⁾ devices CM-MPS.23 and CM-MPS.43



Applications

- Control for connection of moving equipment (e.g. air conditioning compressors, refrigerated trucks and containers, and cranes)
- Control against reverse motor operation (lifting, handling, elevators, escalators, etc.)
- Control of sensitive three-phase supplies
- Overheating of the motor due to asymmetrical voltage
- Protection of a plant against destruction due to overvoltage
- Direction of rotation of the drive





—
Three-phase monitoring relays have many functions to protect various applications

Three-phase monitoring relays

Function

Phase unbalance monitoring

If the supply by the three-phase system is unbalanced due to an uneven distribution of the load, the motor will convert a part of the energy into reactive power. This energy gets lost unexploited; also the motor is exposed to higher thermal stress. Other thermal protection devices fail to detect continuing unbalances, which can lead to damage or destruction of the motor. The CM range three-phase monitors with phase unbalance monitoring can reliably detect this critical situation.

Phase sequence

Changing the phase sequence during operation or a wrong phase sequence prior to startup causes a change of the rotational direction of the connected device. Generators, pumps or fans rotate in the wrong direction and the installation is no longer working properly. In particular, for moveable equipment, such as construction machinery, phase sequence detection prior to the startup process is highly reasonable.

Phase loss

In case of phase loss, undefined states of the installation are likely to occur; e.g. the startup process of motors is disturbed. All three-phase monitors of the ABB CM range detect a phase loss as soon as the voltage of one phase drops below 60 % of its nominal value.

Voltage monitoring

All electric devices can be damaged when operated continuously in a network with out-of-range voltages. For example, safe starting is not ensured in case of undervoltage. Also, the switching state of a contactor is not clearly defined when operated in a "forbidden" voltage range. This can lead to undefined states of the installation and cause damage or destruction of valuable parts.

Selectable phase sequence monitoring

The phase sequence monitoring can be switched off by means of a rotary switch or a DIP switch. This enables monitoring of three-phase mains where phase sequence is not relevant for the application, for example in case of motors with forward and reverse rotation, heating applications, etc.

Automatic phase sequence correction

The automatic phase sequence correction is activated by means of a DIP switch. With activated phase sequence correction, it is ensured that for any non-fixed or portable equipment, e.g. construction machinery, the correct phase sequence is always applied to the input terminals of the load. For details regarding the wiring, please see function description / diagrams.

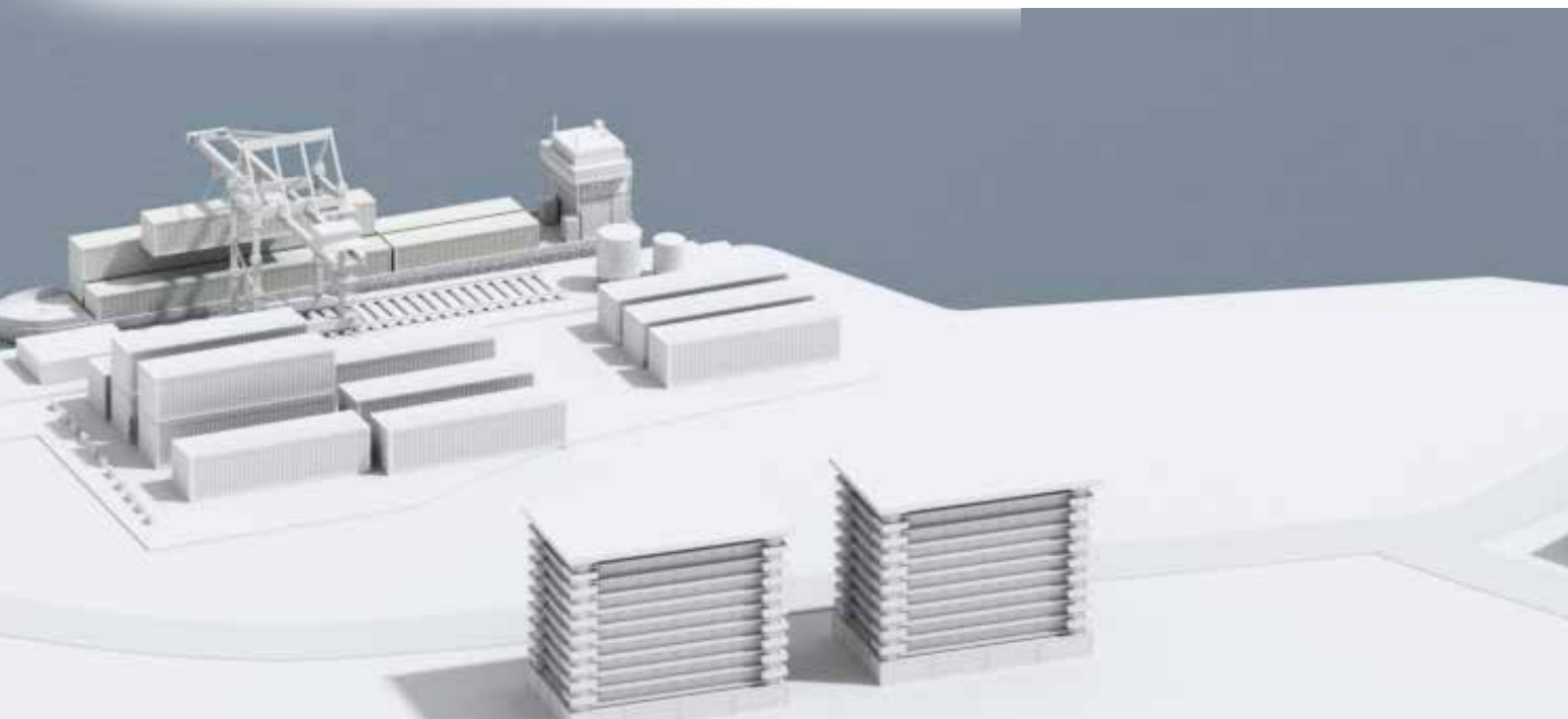

Three-phase monitoring relays

Operating controls

S-range housing

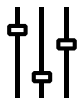

Adjustment of the threshold value $>U$ for overvoltage

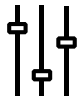

Adjustment of the threshold value Asymmetry for phase unbalance



DIP switches

- ON-delay
- OFF-delay
- Phase sequence monitoring deactivated
- Phase sequence monitoring activated
- Phase sequence correction activated
- Phase sequence correction deactivated
- 2x1 c/o (SPDT) contact
- 1x2 c/o (SPDT) contacts

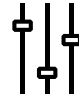

Adjustment of the threshold value $<U$ for undervoltage



Indication of operational states
 R/T: red LED – Relay status / timing
 F1: yellow LED – Fault message
 F2: yellow LED – Fault message

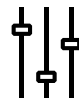

Adjustment of the tripping delay T

Three-phase monitoring relays

Operating controls

N-range housing

The image shows an ABB CM-MPN three-phase monitoring relay. It features three phase inputs labeled L1, L2, and L3 at the top. The main body contains several adjustment knobs: '>U V' (set to 520 V), '<U V' (set to 400 V), 'Asym. %' (set to 13%), and 'Time s' (set to 8 s). On the right side, there are three LEDs labeled R/T, F1, and F2. At the bottom, there are six terminals labeled 16, 15, 18, 26, 25, and 28. A red horizontal band with the ABB logo is visible across the middle of the device.

Adjustment of the threshold value >U for overvoltage

Adjustment of the threshold value <U for undervoltage

Adjustment of the threshold value Asymmetry for phase unbalance

Adjustment of the tripping delay T

Indication of operational states
 R/T: red LED – Relay status / timing
 F1: yellow LED – Fault message
 F2: yellow LED – Fault message

DIP switches

- ON-delay
- OFF-delay
- Phase sequence monitoring deactivated
- Phase sequence monitoring activated
- Phase sequence correction activated
- Phase sequence correction deactivated
- 2x1 c/o (SPDT) contact
- 1x2 c/o (SPDT) contacts

Three-phase monitoring relays

Selection table - singlefunctional

Type	Order number	CM-PBE	CM-PBE	CM-PVE	CM-PVE	CM-PFE	CM-PFE.2	CM-PFS.S	CM-PFS.P	CM-PSS.31S	CM-PSS.31P	CM-PSS.41S	CM-PSS.41P	CM-PVS.31S	CM-PVS.31P	CM-PVS.41S	CM-PVS.41P	CM-PVS.81S	CM-PVS.81P	CM-PAS.31S	CM-PAS.31P	CM-PAS.41S	CM-PAS.41P	
	1SVR550881R9400																							
	1SVR550882R9500																							
	1SVR550870R9400																							
	1SVR550871R9500																							
	1SVR550824R9100																							
	1SVR550826R9100																							
	1SVR730824R9300																							
	1SVR740824R9300																							
	1SVR730784R2300																							
	1SVR740784R2300																							
	1SVR730784R3300																							
	1SVR740784R3300																							
	1SVR730794R1300																							
	1SVR740794R1300																							
	1SVR730794R3300																							
	1SVR740794R3300																							
	1SVR730794R2300																							
	1SVR740794R2300																							
	1SVR730774R1300																							
	1SVR740774R1300																							
	1SVR730774R3300																							
	1SVR740774R3300																							
Rated control supply voltage U_s																								
Phase to phase																								
160-300 V AC																								
200-400 V AC																								
200-500 V AC																								
208-440 V AC																								
300-500 V AC																								
320-460 V AC																								
380 V AC																								
380-440 V AC																								
400 V AC																								
Phase to neutral																								
185-265 V AC																								
220-240 V AC																								
Rated frequency																								
50/60 Hz																								
Suitable for monitoring																								
Single-phase mains																								
Three-phase mains																								
Monitoring function																								
Phase failure																								
Phase sequence																								
Overvoltage																								
Undervoltage																								
Unbalance																								
Neutral ⁽¹⁾																								
Thresholds																								
adjustable (adj) or fixed (fix)																								
Timing functions for tripping delay																								
ON delay																								
On and OFF delay																								
Connection type																								
Push-in terminals																								
Double-chamber cage connection terminals																								

(1) The external conductor voltage towards the neutral conductor is measured.

adj: adjustable
 sel: selectable
 fix: fixed

Three-phase monitoring relays

Ordering details - singlefunctional



CM-PBE



CM-PSS.41P



CM-PAS.31P

Description

The three-phase monitoring relays are designed for use in three-phase mains for monitoring the phase parameters like phase sequence, phase failure, over- and undervoltage, as well as phase unbalance.

Ordering details

Characteristics	Type	Order code	Weight (1 pc) kg (lb)
See selection table	CM-PBE	1SVR550881R9400	0.08 (0.17)
	CM-PBE	1SVR550882R9500	0.08 (0.17)
	CM-PVE	1SVR550870R9400	0.08 (0.17)
	CM-PVE	1SVR550871R9500	0.08 (0.17)
	CM-PFE	1SVR550824R9100	0.08 (0.17)
	CM-PFE.2	1SVR550826R9100	0.067 (0.147)

Characteristics	Type	Order code	Weight (1 pc) kg (lb)
See selection table	CM-PFS.S	1SVR730824R9300	0.127 (0.280)
	CM-PFS.P	1SVR740824R9300	0.119 (0.262)
	CM-PSS.31S	1SVR730784R2300	0.132 (0.291)
	CM-PSS.31P	1SVR740784R2300	0.123 (0.271)
	CM-PSS.41S	1SVR730784R3300	0.132 (0.291)
	CM-PSS.41P	1SVR740784R3300	0.123 (0.271)
	CM-PVS.31S	1SVR730794R1300	0.141 (0.311)
	CM-PVS.31P	1SVR740794R1300	0.132 (0.291)
	CM-PVS.41S	1SVR730794R3300	0.139 (0.306)
	CM-PVS.41P	1SVR740794R3300	0.131 (0.289)
	CM-PVS.81S	1SVR730794R2300	0.136 (0.300)
	CM-PVS.81P	1SVR740794R2300	0.128 (0.282)
	CM-PAS.31S	1SVR730774R1300	0.133 (0.293)
	CM-PAS.31P	1SVR740774R1300	0.124 (0.273)
	CM-PAS.41S	1SVR730774R3300	0.132 (0.291)
	CM-PAS.41P	1SVR740774R3300	0.123 (0.271)

S: screw connection
 P: push-in connection

Three-phase monitoring relays

Selection table - multifunctional

	Type	Order number																		
	CM-MPS.11S	1SVR730885R1300																		
	CM-MPS.11P	1SVR740885R1300																		
	CM-MPS.21S	1SVR730885R3300																		
	CM-MPS.21P	1SVR740885R3300																		
	CM-MPS.31S	1SVR730884R1300																		
	CM-MPS.31P	1SVR740884R1300																		
	CM-MPS.41S	1SVR730884R3300																		
	CM-MPS.41P	1SVR740884R3300																		
	CM-MPS.23S	1SVR730885R4300																		
	CM-MPS.23P	1SVR740885R4300																		
	CM-MPS.43S	1SVR730884R4300																		
	CM-MPS.43P	1SVR740884R4300																		
	CM-MPN.52S	1SVR750487R8300																		
	CM-MPN.52P	1SVR760487R8300																		
	CM-MPN.62S	1SVR750488R8300																		
	CM-MPN.62P	1SVR760488R8300																		
	CM-MPN.72S	1SVR750489R8300																		
	CM-MPN.72P	1SVR760489R8300																		
Rated control supply voltage U_c																				
Phase to phase																				
160-300 V AC																				
300-500 V AC																				
350-580 V AC																				
450-720 V AC																				
530-820 V AC																				
Phase to neutral																				
90-170 V AC																				
180-280 V AC																				
Rated frequency																				
50/60 Hz																				
50/60/400 Hz																				
Suitable for monitoring																				
Mains with harmonic content																				
Single-phase mains																				
Three-phase mains																				
Monitoring function																				
Phase failure																				
Phase sequence	sel	sel	sel	sel	sel	sel	sel	sel	adj	adj	adj	adj	adj	adj	adj	adj	adj	adj	adj	
Automatic phase sequence correction									adj	adj	adj	adj	adj	adj	adj	adj	adj	adj	adj	
Overvoltage																				
Undervoltage																				
Unbalance																				
Interrupted neutral monitoring ¹⁾																				
Thresholds																				
Adjustable (adj)	adj	adj	adj	adj	adj	adj	adj	adj	adj	adj	adj	adj	adj	adj	adj	adj	adj	adj	adj	adj
Timing functions for tripping delay																				
On- or OFF delay	adj	adj	adj	adj	adj	adj	adj	adj	adj	adj	adj	adj	adj	adj	adj	adj	adj	adj	adj	adj
Connection type																				
Push-in terminals																				
Double-chamber cage connection terminals																				

1) The relay detects by means of a phase unbalance the interruption of the neutral conductor. The external conductor voltage towards the neutral conductor is measured too.

adj: adjustable
 sel: selectable

Three-phase monitoring relays

Ordering details - multifunctional



CM-MPS.23P

2CDC251.065.V0011



CM-MPN.52P

2CDC251.062.V0011

Description

The three-phase monitoring relays are designed for use in three-phase mains for monitoring the phase parameters, such as phase sequence, phase failure, over- and undervoltage, as well as phase unbalance.

Ordering details

Characteristics	Type	Order code	Weight (1 pc) kg (lb)
See selection table	CM-MPS.11S	1SVR730885R1300	0.148 (0.326)
	CM-MPS.11P	1SVR740885R1300	0.137 (0.302)
	CM-MPS.21S	1SVR730885R3300	0.146 (0.322)
	CM-MPS.21P	1SVR740885R3300	0.135 (0.298)
	CM-MPS.31S	1SVR730884R1300	0.142 (0.313)
	CM-MPS.31P	1SVR740884R1300	0.133 (0.293)
	CM-MPS.41S	1SVR730884R3300	0.140 (0.309)
	CM-MPS.41P	1SVR740884R3300	0.132 (0.291)
	CM-MPS.23S	1SVR730885R4300	0.149 (0.328)
	CM-MPS.23P	1SVR740885R4300	0.138 (0.304)
	CM-MPS.43S	1SVR730884R4300	0.148 (0.327)
	CM-MPS.43P	1SVR740884R4300	0.137 (0.302)
	CM-MPN.52S	1SVR750487R8300	0.230 (0.507)
	CM-MPN.52P	1SVR760487R8300	0.226 (0.498)
	CM-MPN.62S	1SVR750488R8300	0.229 (0.505)
	CM-MPN.62P	1SVR760488R8300	0.225 (0.496)
	CM-MPN.72S	1SVR750489R8300	0.224 (0.494)
	CM-MPN.72P	1SVR760489R8300	0.220 (0.485)

S: screw connection
P: push-in connection

Three-phase monitoring relays

Technical data

Type	CM-PBE ¹⁾	CM-PBE	CM-PVE ¹⁾	CM-PVE	CM-PFE	CM-PFE.2	CM-PFS
Input circuit - supply circuit	L1-L2-L3-N	L1-L2-L3	L1-L2-L3-N	L1-L2-L3			
Rated control supply voltage U_s = measuring voltage	3x380-440 V AC, 220-240 V AC	3x380-440 V AC	3x320-460 V AC, 185-265 V AC	3x320-460 V AC	3x208-440 V AC	3x200-500 V AC	
Power consumption						13 mA / 9 VA	approx. 15 VA
Rated control supply voltage U_s tolerance	-15...+15 %		-15...+10 %				
Rated frequency	50/60 Hz		50/60 Hz (-10...+10 %)		50/60 Hz		
Duty time	100 %						
Input circuit - measuring circuit	L1-L2-L3-N	L1-L2-L3	L1-L2-L3-N	L1-L2-L3			
Monitoring functions							
phase failure	■	■	■	■	■	■	■
phase sequence	-	-	-	-	■	■	■
over- / undervoltage	-	-	■	■	-	-	-
neutral	■	-	■	-	-	-	-
Measuring ranges	3x380-440 V AC, 220-240 V AC	3x380-440 V AC	3x320-460 V AC, 185-265 V AC	3x320-460 V AC	3x208-440 V AC	3x200-500 V AC	
Thresholds	U_{min} 0.6 x U_N		fixed 185 V / 320 V	fixed 320 V	$0.6 \times U_N$		
	U_{max} -		fixed 265 V / 460 V	fixed 460 V	-		
Hysteresis related to the threshold value	fixed 5 % (release value = 0.65 x U_N)		fixed 5 %		-		
Measuring voltage frequency	50/60 Hz (-10 %...+10 %)				50/60 Hz		
Response time	40 ms		80 ms		500 ms		
Accuracy within the temperature range	-		$\Delta U \leq 0.06 \% / ^\circ C$				
Timing circuit							
Start-up delay t_s	fixed 500 ms ($\pm 20 \%$)				fixed 500 ms		
Tripping t_v	fixed 150 ms ($\pm 20 \%$)		at over- / undervoltage fixed 500 ms ($\pm 20 \%$)		fixed 500 ms		-
Indication of operational states							
Relay status	R: yellow LED	┌───┐ output relay energized					
Fault message	F: red LED	Only CM-PFS: ┌───┐ phase failure / ┌───┐ phase sequence error					

Three-phase monitoring relays

Technical data

Type	CM-PBE ¹⁾	CM-PBE	CM-PVE ¹⁾	CM-PVE	CM-PFE	CM-PFE.2	CM-PFS	
Output circuits	13-14				11-12/14		11 ₁₅ -12 ₁₆ / 14 ₁₈ , 21 ₂₅ -22 ₂₆ / 24 ₂₈	
Kind of output	1 n/o contact				1 c/o contact		2 c/o contacts	
Operating principle	closed-circuit principle ²⁾							
Minimum switching voltage / Minimum switching current	24 V / 10 mA							
Maximum switching voltage / maximum switching voltage	see data sheets							
Rated operational voltage U _e and rated operational current I _e	AC-12 (resistive) 230 V	4 A						
	AC-15 (inductive) 230 V	3 A						
	DC-12 (resistive) 24 V	4 A						
	DC-13 (inductive) 24 V	2 A						
AC rating (UL 508)	Utilization category (Control Circuit Rating Code)	B 300 pilot duty, general purpose 250 V, 4 A, cos phi 0.75						
	max. rated operational voltage	300 V AC						
	max. continuous thermal current at B 300	5 A						
	max. making/breaking apparent power at B 300	3600/360 VA						
Mechanical lifetime	30 x 10 ⁶ switching cycles							
Electrical lifetime (AC-12, 230 V, 4 A)	0.1 x 10 ⁶ switching cycles							
Max. fuse rating to achieve short-circuit protection	n/c contact	10 A fast-acting				6 A fast-acting		
	n/o contact	10 A fast-acting						
Conventional thermal current I _{th}					4 A			

1) Device with neutral monitoring: The external conductor voltage towards the neutral conductor is measured.

2) Closed-circuit principle: Output relay is de-energized if the measured value exceeds/drops below the adjusted threshold.

Three-phase monitoring relays

Technical data

Type		CM-PBE ¹⁾	CM-PBE	CM-PVE ¹⁾	CM-PVE	CM-PFE	CM-PFE.2	CM-PFS	
General data									
Duty cycle		100 %							
Dimensions		see dimensional drawings							
Mounting		DIN rail (IEC/EN 60715)							
Mounting position		any							
Minimum distance to other unites	horizontal	not necessary				≥ 10 mm if ambient temperature > 50 °C and rated operational currents > 2 A		≥ 10 mm in case of continuous measuring voltage > 440 V	
Degree of protection	housing / terminals	IP50 / IP20							
Electrical connection									
Connecting capacity	fine-strand with wire end ferrule	2 x 0.75-1.5 mm ² (2 x 18-16 AWG)						Same as CM-PSS.31	
	fine-strand without wire end ferrule	2 x 1-1.5 mm ² (2 x 18-16 AWG)							
	rigid	2 x 0.75-1.5 mm ² (2 x 18-16 AWG)							
Stripping length		10 mm (0.39 in)						Same as CM-PSS.31	
Tightening torque		0.6-0.8 Nm							
Environmental data									
Ambient temperature range	operation / storage	-20...+60 °C / -40...+85 °C							
Climatic class		-				3K3			
Damp heat	IEC/EN 60068-2-30	40 °C, 93 % RH, 4 days				-			
Damp heat, cyclic	IEC/EN 60068-2-30					6 x 24 h cycle, 55 °C, 95 % RH			
Vibration withstand	IEC/EN 60068-2-6	10-57 Hz: 0.075 mm; 57-150 Hz: 1 g							
Vibration, sinusoidal		-				class 2			
Shock		-				class 2			
Isolation data									
Rated insulation voltage U _i	between input, measuring and output circuits	400 V				-			
	input circuit / output circuit	-				600 V			
	output circuit 1 / output circuit 2	-				300 V			
Rated impulse withstand voltage U _{imp}	between input, measuring and output circuits	4 kV / 1.2 -50 μs				-			
	input circuit / output circuit	-				6 kV			
	output circuit 1 / output circuit 2	-				4 kV			
Basic insulation	supply circuit / output circuit	-				600 V AC			
Pollution degree		3							
Overvoltage category		III							
Standards / Directives									
Standards		IEC/EN 60947-5-1				IEC/EN 60255-27, IEC/EN 60947-5-1			
Low Voltage Directive		2014/35/EU							
EMC Directive		2014/30/EU							
RoHS Directive		2011/65/EU							

Three-phase monitoring relays

Technical data

Type	CM-PBE ⁽¹⁾	CM-PBE	CM-PVE ⁽¹⁾	CM-PVE	CM-PFE	CM-PFE.2	CM-PFS
Electromagnetic compatibility							
Interference immunity to		IEC/EN 61000-6-2					
electrostatic discharge	IEC/EN 61000-4-2	level 3 - 6 kV/ 8 kV					
radiated, radio-frequency, electromagnetic field	IEC/EN 61000-4-3	level 3 - 10 V/m					level 3 - 10 V/m (1 GHz) 3 V/m (2 GHz) 1 V/m (2.7 GHz)
electrical fast transient / burst	IEC/EN 61000-4-4	level 3 - 2 kV / 5 kHz					
surge	IEC/EN 61000-4-5	level 4 - 2 kV L-L					
conducted disturbances, induced by radio-frequency fields	IEC/EN 61000-4-6	level 3 - 10 V					
voltage dips, short interruptions and voltage variations	IEC/EN 61000-4-11	-					class 3
harmonics and interharmonics	IEC/EN 61000-4-13	-					class 3
Interference emission		IEC/EN 61000-6-3					
high-frequency radiated	IEC/CISPR 22, EN 55022	Class B					
high-frequency conducted	IEC/CISPR 22, EN 55022	Class B					

(1) Device with neutral monitoring: The external conductor voltage towards the neutral conductor is measured.

Three-phase monitoring relays

Technical data

Type	CM-PSS.31	CM-PSS.41	CM-PVS.31	CM-PVS.41	CM-PVS.81	CM-PAS.31	CM-PAS.41
Input circuit = Measuring circuit	L1, L2, L3						
Rated control supply voltage U_s = measuring voltage	3x380 V AC	3x400 V AC	3x160-300 V AC	3x300-500 V AC	3x200-400 V AC	3x160-300 V AC	3x300-500 V AC
Rated control supply voltage U_s tolerance	-15...+10 %						
Rated frequency	50/60 Hz						
Frequency range	45-65 Hz						
Typical current / power consumption	25 mA / 18 VA (380 V AC)	25 mA / 18 VA (400 V AC)	25 mA / 10 VA (230 V AC)	25 mA / 18 VA (400 V AC)	19 mA / 10 VA (300 V AC)	25 mA / 10 VA (230 V AC)	25 mA / 18 VA (400 V AC)
Measuring circuit	L1, L2, L3						
Monitoring functions	Phase failure	■	■	■	■	■	■
	Phase sequence	can be switched off				■	■
	Automatic phase sequence correction	-	-	-	-	-	-
	Over- / undervoltage	■	■	■	■	-	-
	Phase unbalance	-	-	-	-	■	■
	Neutral	-	-	-	-	-	-
Measuring range	Overvoltage	3x418 V AC	3x440 V AC	3x220-300 V AC	3x420-500 V AC	3x300-400 V AC	-
	Undervoltage	3x342 V AC	3x360 V AC	3x160-230 V AC	3x300-380 V AC	3x210-300 V AC	-
	Phase unbalance	-	-	-	-	-	2-25 % of average of phase voltages
Thresholds	Overvoltage	fixed		adjustable within measuring range			-
	Undervoltage	fixed		adjustable within measuring range			-
	Phase unbalance (switch-off value)	-	-	-	-	-	adjust. within measuring range
Tolerance of the adjusted threshold value	6 % of full-scale value						
Hysteresis related to the threshold value	Over- / undervoltage	fixed 5 %				-	
	Phase unbalance	-	-	-	-	-	fixed 20 %
Maximum measuring cycle time	100 ms						
Accuracy within the temperature range	$\Delta U \leq 0.06 \% / ^\circ\text{C}$						
Measuring method	true RMS						
Timing circuit							
Start-up delay t_s	fixed 200 ms						
Tripping delay t_v	ON- or OFF-delay 0; 0.1-30 s adjustable					ON- delay 0; 0.1-30 s adjustable	
Repeat accuracy (constant parameters)	-	-	-	-	< $\pm 0.2 \%$	-	-
Accuracy within the rated control supply voltage tolerance	$\Delta t \leq 0.5 \%$						
Accuracy within the temperature range	$\Delta t \leq 0.06 \% / ^\circ\text{C}$						
Indication of operational states							
		1 yellow LED, 2 red LEDs					
	details see function description / -diagrams	details see operating mode and function description / -diagrams			details see function description / -diagrams		
Output circuits	15-16/18, 25-26/28						
Kind of output	relay, 2 x 1 c/o contact						
Operating principle	closed-circuit principle ¹⁾						
Contact material	AgNi alloy, Cd free						
Minimum switching power	24 V / 10 mA						
Maximum switching voltage	see "Load limit curves"						

1) Closed-circuit principle: Output relay(s) de-energize(s) if measured value exceeds or falls below the adjusted threshold value

Three-phase monitoring relays

Technical data

Type		CM-PSS.31	CM-PSS.41	CM-PVS.31	CM-PVS.41	CM-PVS.81	CM-PAS.31	CM-PAS.41	
Rated operational voltage U_e and rated operational current I_e	AC-12 (resistive) 230 V	4 A							
	AC-15 (inductive) 230 V	3 A							
	DC-12 (resistive) 24 V	4 A							
	DC-13 (inductive) 24 V	2 A							
AC rating (UL 508)	Utilization category (Control Circuit Rating Code)	B 300							
	max. rated operational voltage	300 V AC							
	max. continuous thermal current at B 300	5 A							
	max. making/breaking apparent power at B 300	3600/360 VA							
Mechanical lifetime	30 x 10 ⁶ switching cycles								
Electrical lifetime (AC-12, 230 V, 4 A)	0.1 x 10 ⁶ switching cycles								
Max. fuse rating to achieve short-circuit protection	n/c contact	6 A fast-acting							
	n/o contact	10 A fast-acting							
General data									
MTBF	on request								
Duty cycle	100%								
Dimensions	see dimensional drawings								
Mounting	DIN rail (IEC/EN 60715), snap-on mounting without any tool								
Mounting position	any								
Minimum distance to other units	horizontal	10 mm (0.39 in) in case of continuous measuring voltages							
		> 400 V	> 400 V	> 220 V	> 400 V	-	> 220 V	> 400 V	
Material of housing	UL 94 V-0								
Degree of protection	housing / terminals	IP50 / IP20							
Electrical connection									
Wire size	fine-strand with(out) wire end ferrule	Screw connection technology				Easy Connect Technology (Push-in)			
		1 x 0.5-2.5 mm ² (1 x 18-14 AWG) 2 x 0.5-1.5 mm ² (2 x 18-16 AWG)				2 x 0.5-1.5 mm ² (2 x 18-16 AWG)			
		1 x 0.5-4 mm ² (1 x 20-12 AWG) 2 x 0.5-2.5 mm ² (2 x 20-14 AWG)				2 x 0.5-1.5 mm ² (2 x 20-16 AWG)			
Stripping length	8 mm (0.32 in)								
Tightening torque	0.6-0.8 Nm (7.08 lb.in)				-				
Environmental data									
Ambient temperature ranges	operation / storage	-25...+60 °C / -40...+85 °C							
Damp heat, cyclic (IEC 60068-2-30)	6 x 24 h cycle, 55 °C, 95 % RH								
Climatic class	3K3								
Vibration (sinusoidal)	class 2								
Shock	class 2								
Isolation data									
Rated insulation voltage U_i	input circuit / output circuit	600 V							
	output circuit 1 / output circuit 2	300 V							
Rated impulse withstand voltage U_{imp}	input circuit	6 kV; 1.2/50 μ s							
	output circuit	4 kV; 1.2/50 μ s							
Basic insulation	input circuit / output circuit	600 V							
Protective separation	input circuit / output circuit	-							
Pollution degree	3								
Overtoltage category	III								

Three-phase monitoring relays

Technical data

Type	CM-PSS.31	CM-PSS.41	CM-PVS.31	CM-PVS.41	CM-PVS.81	CM-PAS.31	CM-PAS.41
Standards / Directives							
Standards	IEC/EN 60255-27, IEC/EN 60947-5-1						
Low Voltage Directive	2014/35/EU						
EMC directive	2014/30/EU						
RoHS directive	2011/65/EU						
Electromagnetic compatibility							
Interference immunity to	EN 61000-6-1						
electrostatic discharge	IEC/EN 61000-4-2	Level 3 (6 kV / 8 kV)					
radiated, radio-frequency, electromagnetic field	IEC/EN 61000-4-3	Level 3 (10 V/m)					
electrical fast transient / burst	IEC/EN 61000-4-4	Level 3 (2 kV / 2 kHz)					
surge	IEC/EN 61000-4-5	Level 4 (2 kV L-L)					
conducted disturbances, induced by radio-frequency fields	IEC/EN 61000-4-6	Level 3 (10 V)					
Interference emission	IEC/EN 61000-6-3						
high-frequency radiated	IEC/CISPR 22, EN 55022	class B					
high-frequency conducted	IEC/CISPR 22, EN 55022	class B					

Three-phase monitoring relays

Technical data

Type	CM-MPS.11	CM-MPS.21	CM-MPS.31	CM-MPS.41
Input circuit = Measuring circuit	L1, L2, L3, N		L1, L2, L3	
Rated control supply voltage U_s = measuring voltage	3x90-170 V AC	3x180-280 V AC	3x160-300 V AC	3x300-500 V AC
Rated control supply voltage U_s tolerance	-15...+10 %			
Rated frequency	50/60 Hz			
Frequency range	45-65 Hz			
Typical current / power consumption	25 mA / 10 VA (115 V AC)	25 mA / 18 VA (230 V AC)	25 mA / 10 VA (230 V AC)	25 mA / 18 VA (400 V AC)
Measuring circuit	L1, L2, L3, N		L1, L2, L3	
Monitoring functions	Phase failure	■	■	■
	Phase sequence	can be switched off		
	Automatic phase sequence correction	-	-	-
	Over- / undervoltage	■	■	■
	Phase unbalance	■	■	■
	Interrupted neutral	■	■	-
Measuring range	Overtoltage	3x120-170 V AC	3x240-280 V AC	3x220-300 V AC
	Undervoltage	3x90-130 V AC	3x180-220 V AC	3x160-230 V AC
	Phase unbalance	2-25 % of average of phase voltages		
Thresholds	Overtoltage	adjustable within measuring range		
	Undervoltage	adjustable within measuring range		
	Phase unbalance (switch-off value)	adjustable within measuring range		
Tolerance of the adjusted threshold value	6 % of full-scale value			
Hysteresis related to the threshold value	Over- / undervoltage	fixed 5 %		
	Phase unbalance	fixed 20 %		
Accuracy within the temperature range	$\Delta U \leq 0.06 \% / ^\circ\text{C}$			
Measuring method	True RMS			
Timing circuit				
Start-up delay t_s	fixed 200 ms			
Tripping delay t_v	ON- or OFF-delay 0; 0.1-30 s adjustable			
Accuracy within the rated control supply voltage tolerance	$\Delta t \leq 0.5 \%$			
Accuracy within the temperature range	$\Delta t \leq 0.06 \% / ^\circ\text{C}$			
Indication of operational states	Details see function description / -diagrams			
Output circuits	15-16/18, 25-26/28			
Kind of output	relay, 1 x 2 c/o contacts			
Operating principle	closed-circuit principle ¹⁾			
Contact material	AgNi alloy, Cd free			
Minimum switching power	24 V / 10 mA			
Maximum switching voltage	see load limit curves			
Rated operational voltage U_e and rated operational current I_e	AC-12 (resistive) 230 V	4 A		
	AC-15 (inductive) 230 V	3 A		
	DC-12 (resistive) 24 V	4 A		
	DC-13 (inductive) 24 V	2 A		
AC rating (UL 508)	Utilization category (Control Circuit Rating Code)	B 300		
	max. rated operational voltage	300 V AC		
	max. continuous thermal current at B 300	5 A		
	max. making/breaking apparent power at B 300	3600/360 VA		
Mechanical lifetime	30 x 10 ⁶ switching cycles			
Electrical lifetime (AC-12, 230 V, 4 A)	0.1 x 10 ⁶ switching cycles			
Max. fuse rating to achieve short-circuit protection	n/c contact	6 A fast-acting		
	n/o contact	10 A fast-acting		

1) Closed-circuit principle: Output relay(s) de-energize(s) if measured value exceeds or falls below the adjusted threshold value

Three-phase monitoring relays

Technical data

Type	CM-MPS.11	CM-MPS.21	CM-MPS.31	CM-MPS.41
General data				
MTBF	on request			
Duty time	100 %			
Dimensions	see dimension drawings			
Mounting	DIN rail (IEC/EN 60715), snap-on mounting without any tool			
Mounting position	any			
Minimum distance to other units	horizontal	10 mm (0.39 in) in case of continuous measuring voltages		
		> 120 V	> 240 V	> 220 V
				> 400 V
Material of housing	UL 94 V-0			
Degree of protection	housing / terminals	IP50 / IP20		
Electrical connection				
Wire size		Screw connection technology	Easy Connect Technology (Push-in)	
	fine-strand with(out) wire end	1 x 0.5-2.5 mm ² (1 x 18-14 AWG)	2 x 0.5-1.5 mm ² (2 x 18-16 AWG)	
	ferrule	2 x 0.5-1.5 mm ² (2 x 18-16 AWG)		
	rigid	1 x 0.5-4 mm ² (1 x 20-12 AWG)	2 x 0.5-1.5 mm ² (2 x 20-16 AWG)	
		2 x 0.5-2.5 mm ² (2 x 20-14 AWG)		
Stripping length	8 mm (0.32 in)			
Tightening torque	0.6-0.8 Nm (7.08 lb.in)		-	
Environmental data				
Ambient temperature ranges	operation / storage	-25...+60 °C / -40...+85 °C		
Damp heat, cyclic	6 x 24 h cycle, 55 °C, 65 % RH			
Climatic class	3K3			
Vibration	class 2			
Shock	class 2			
Isolation data				
Rated insulation voltage U _i	input circuit / output circuit	600 V		
	output circuit 1 / output circuit 2	300 V		
Rated impulse withstand voltage U _{imp}	input circuit	6 kV; 1.2/50 μs		
	output circuit	4 kV; 1.2/50 μs		
Test voltage between all isolated circuits (routine test)	2.5 kV, 50 Hz, 1 s			
Basic insulation	input circuit / output circuit	600 V		
Protective separation (IEC/EN 61140)	input circuit / output circuit	yes	-	
Pollution degree	3			
Overvoltage category	III			
Standards / Directives				
Standards	IEC/EN 60255-2, IEC/EN 60947-5-1			
Low Voltage Directive	2014/35/EU			
EMC directive	2014/30/EU			
RoHS directive	2011/65/EU			
Electromagnetic compatibility				
Interference immunity to	IEC/EN 61000-6-2			
electrostatic discharge	IEC/EN 61000-4-2	level 3 (6 kV / 8 kV)		
radiated, radio-frequency, electromagnetic field	IEC/EN 61000-4-3	level 3 (10 V/m)		
electrical fast transient / burst	IEC/EN 61000-4-4	level 3 (2 kV / 2 kHz)		
surge	IEC/EN 61000-4-5	level 4 (2 kV L-N)	Level 4 (2 kV L-L)	
conducted disturbances, induced by radio-frequency fields	IEC/EN 61000-4-6	level 3 (10 V)		
harmonics and interharmonics	IEC/EN 61000-4-13	class 3		
Interference emission	EN 61000-6-3, EN 61000-6-4			
high-frequency radiated	IEC/CISPR 22, EN 55022	class B		
high-frequency conducted	IEC/CISPR 22, EN 55022	class B		

Three-phase monitoring relays

Technical data

Type	CM-MPS.23	CM-MPS.43	CM-MPN.52	CM-MPN.62	CM-MPN.72	
Input circuit = Measuring circuit	L1, L2, L3, N	L1, L2, L3				
Rated control supply voltage U_s = measuring voltage	3x180-280 V AC	3x300-500 V AC	3x350-580 V AC	3x450-720 V AC	3x530-820 V AC	
Rated control supply voltage U_s tolerance	-15...+10 %					
Rated frequency	50/60/400 Hz		50/60 Hz			
Frequency range	45-440 Hz		45-65 Hz			
Typical current / power consumption	5 mA / 4 VA (230 V AC)	5 mA / 4 VA (400 V AC)	29 mA / 41 VA (480 V AC)	29 mA / 52 VA (600 V AC)	29 mA / 59 VA (690 V AC)	
Measuring circuit	L1, L2, L3, N	L1, L2, L3				
Monitoring functions	Phase failure	■	■	■	■	
	Phase sequence	can be switched off				
	Automatic phase sequence correction	configurable				
	Over- / undervoltage	■	■	■	■	■
	Phase unbalance	■	■	■	■	■
	Interrupted neutral	■	-	-	-	
Measuring range	Overvoltage	3x240-280 V AC	3x420-500 V AC	3x480-580 V AC	3x600-720 V AC	3x690-820 V AC
	Undervoltage	3x180-220 V AC	3x300-380 V AC	3x350-460 V AC	3x450-570 V AC	3x530-660 V AC
	Phase unbalance	2-25 % of average of phase voltages				
Thresholds	Overvoltage	adjustable within measuring range				
	Undervoltage	adjustable within measuring range				
	Phase unbalance (switch-off value)	adjustable within measuring range				
Tolerance of the adjusted threshold value	6 % of full-scale value					
Hysteresis related to the threshold value	Over- / undervoltage	fixed 5 %				
	Phase unbalance	fixed 20 %				
Maximum measuring cycle time	100 ms					
Accuracy within the temperature range	$\Delta U \leq 0.06 \% / ^\circ\text{C}$					
Measuring method	True RMS					
Timing circuit						
Start-up delay t_s and t_{s2}	fixed 200 ms					
Start-up delay t_{s1}	fixed 250 ms					
Tripping delay t_v	ON- or OFF-delay 0; 0.1-30 s adjustable					
Accuracy within the rated control supply voltage tolerance	$\Delta t \leq 0.5 \%$					
Accuracy within the temperature range	$\Delta t \leq 0.06 \% / ^\circ\text{C}$					
Indication of operational states	Details see function description / -diagrams					
Output circuits	15-16/18, 25-26/28					
Kind of output	relay, 2 x 1 or 1 x 2 c/o contacts configurable					
Operating principle	closed-circuit principle ¹⁾					
Contact material	AgNi alloy, Cd free					
Minimum switching power	24 V / 10 mA					
Maximum switching voltage	see load limit curves					
Rated operational voltage U_e and rated operational current I_e	AC-12 (resistive) 230 V	4 A				
	AC-15 (inductive) 230 V	3 A				
	DC-12 (resistive) 24 V	4 A				
	DC-13 (inductive) 24 V	2 A				
AC rating (UL 508)	Utilization category (Control Circuit Rating Code)	B 300				
	max. rated operational voltage	300 V AC				
	max. continuous thermal current at B 300	5 A				
	max. making/breaking apparent power at B 300	3600/360 VA				
Mechanical lifetime	30 x 10 ⁶ switching cycles					
Electrical lifetime (AC-12, 230 V, 4 A)	0.1 x 10 ⁶ switching cycles					
Max. fuse rating to achieve short-circuit protection	n/c contact	6 A fast-acting		10 A fast-acting		
	n/o contact	10 A fast-acting				

1) Closed-circuit principle: Output relay(s) de-energize(s) if measured value exceeds or falls below the adjusted threshold value

Three-phase monitoring relays

Technical data

Type	CM-MPS.23	CM-MPS.43	CM-MPN.52	CM-MPN.62	CM-MPN.72
General data					
MTBF	on request				
Duty time	100 %				
Dimensions	see dimensional drawings				
Mounting	DIN rail (IEC/EN 60715), snap-on mounting without any tool				
Mounting position	any				
Minimum distance to other units	horizontal	10 mm (0.39 in)	not necessary		
Material of housing	UL 94 V-0				
Degree of protection	housing / terminals	IP50 / IP20			
Electrical connection					
Wire size	Screw connection technology		Easy Connect Technology (Push-in)		
	fine-strand with(out) wire end ferrule	1 x 0.5-2.5 mm ² (1 x 18-14 AWG) 2 x 0.5-1.5 mm ² (2 x 20-16 AWG)	2 x 0.5-1.5 mm ² (2 x 18-16 AWG)		
	rigid	1 x 0.5-4 mm ² (1 x 20-12 AWG) 2 x 0.5-2.5 mm ² (2 x 20-14 AWG)	2 x 0.5-1.5 mm ² (2 x 20-16 AWG)		
Stripping length	8 mm (0.32 in)				
Tightening torque	0.6-0.8 Nm (7.08 lb.in)			-	
Environmental data					
Ambient temperature ranges	operation / storage	-25...+60 °C / -40...+85 °C			
Damp heat, cyclic (IEC 60068-2-30)	6 x 24 h cycles, 55 °C, 95 % RH				
Climatic category	3K3				
Vibration (sinusoidal) (IEC/EN 60255-21-1)	class 2				
Shock (IEC/EN 60255-21-2)	class 2				
Isolation data					
Rated insulation voltage U _i	input circuit / output circuit	600 V	1000 V		
	output circuit 1 / 2	300 V			
Rated impulse withstand voltage U _{imp}	input circuit	6 kV; 1.2/50 μs	8 kV; 1.2/50 μs		
	output circuit	4 kV; 1.2/50 μs			
Basic insulation	input circuit / output circuit	600 V	1000 V		
Protective separation (IEC/EN 61140, EN 50148)	input circuit / output circuit	-			
Pollution degree	3				
Overvoltage category	III				
Standards / Directives					
Standards	IEC/EN 60255-27, IEC/EN 60947-5-1				
Low Voltage Directive	2014/35/EU				
EMC Directive	2014/30/EU				
RoHS Directive	2011/65/EU				
Electromagnetic compatibility					
Interference immunity to	IEC/EN 61000-6-2				
electrostatic discharge	IEC/EN 61000-4-2	level 3 (6 kV / 8 kV)			
radiated, radio-frequency, electromagnetic field	IEC/EN 61000-4-3	level 3 (10 V/m)			
electrical fast transient / burst	IEC/EN 61000-4-4	level 3 (2 kV / 2 kHz)			
surge	IEC/EN 61000-4-5	level 4 (2 kV L-N)	Level 4 (2 kV L-L)		
conducted disturbances, induced by radio-frequency fields	IEC/EN 61000-4-6	level 3 (10 V)			
harmonics and interharmonics	IEC/EN 61000-4-13	class 3			
Interference emission	IEC/EN 61000-6-3				
high-frequency radiated	IEC/CISPR 22, EN 55022	class B			
high-frequency conducted	IEC/CISPR 22, EN 55022	class B			

Three-phase monitoring relays

Technical diagrams

Connection diagrams

CM-PBE, CM-PVE

with neutral

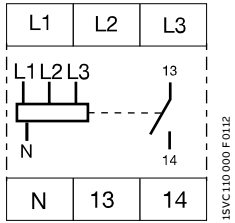

without neutral

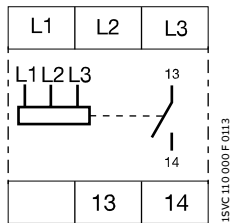

L1, L2, L3, (N) Control supply voltage = Measuring voltage
13-14 Output contact - closed-circuit principle

CM-PFE

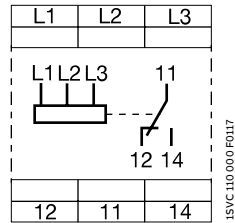

L1, L2, L3 Control supply voltage = Measuring voltage
11-12/14 Output contact - closed-circuit principle

CM-PVS.x1, CM-PSS.x1, CM-PAS.x1

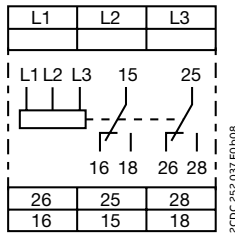

L1, L2, L3 Control supply voltage = Measuring voltage
15-16/18 Output contact - closed-circuit principle
25-26/28

CM-PFS

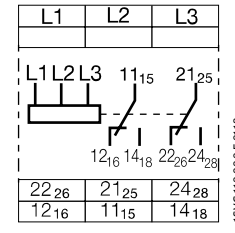

L1, L2, L3 Control supply voltage = Measuring voltage
11₁₅-12₁₆ / 14₁₈ Output contact - closed-circuit principle
21₂₅-22₂₆ / 24₂₈

CM-MPS.11, CM-MPS.21, CM-MPS.23

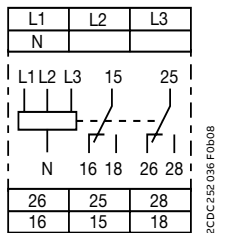

L1, L2, L3, (N) Control supply voltage = Measuring voltage
15-16/18 Output contact - closed-circuit principle
25-26/28

CM-MPS.31, CM-MPS.41, CM-MPS.43

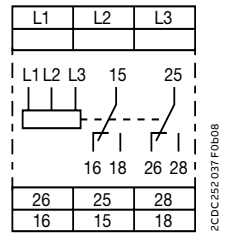

L1, L2, L3, (N) Control supply voltage = Measuring voltage
15-16/18 Output contact - closed-circuit principle
25-26/28

CM-MPN.x2

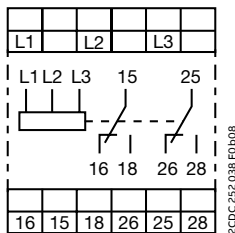

L1, L2, L3 Control supply voltage = Measuring voltage
15-16/18 Output contact - closed-circuit principle
25-26/28

Three-phase monitoring relays

Technical diagrams

Rotary switch "Function"

CM-PVS

	ON-delay with phase sequence monitoring
	OFF-delay with phase sequence monitoring
	ON-delay without phase sequence monitoring
	OFF-delay without phase sequence monitoring

CM-PSS

	ON-delay with phase sequence monitoring
	OFF-delay with phase sequence monitoring
	ON-delay without phase sequence monitoring
	OFF-delay without phase sequence monitoring

DIP switch functions

CM-MPS.x3 and CM-MPN.x2

Position	4	3	2	1	2CDC 252 0-40 F0B08
ON ↑					
OFF					

1 Timing function

ON ON-delayed
OFF OFF-delayed

2 Phase sequence monitoring

ON deactivated
OFF activated

3 Operating principle of output

ON 2x1 c/o contact
OFF 1x2 c/o contact

4 Phase sequence correction

ON activated
OFF deactivated

CM-MPS.x1

Position	2	1	2CDC 252 0-40 F0B08
ON ↑			
OFF			

1 Timing function

ON ON-delayed
OFF OFF-delayed

2 Phase sequence monitoring

ON deactivated
OFF activated

Output relay R1 is responsive to overvoltage, output relay R2 is responsive to undervoltage. In case of other faults, both output relays react synchronously.

Three-phase monitoring relays

Function diagrams

CM-PBE

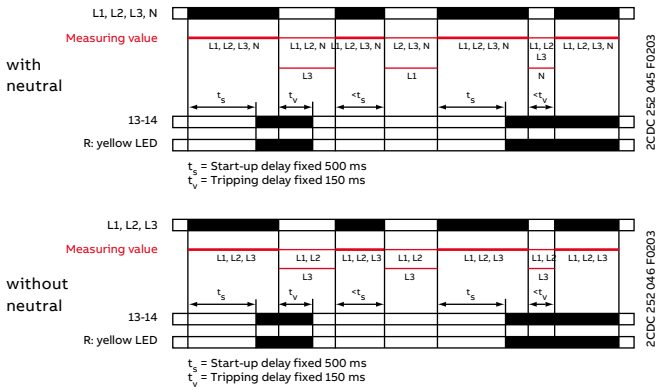

Phase failure detection

If all phases (and the neutral) are present, the output relay energizes after the start-up delay t_s is complete. If a phase failure occurs, the tripping delay t_v starts. When timing is complete, the output relay de-energizes. As soon as the voltage returns to the tolerance range, timing of t_s starts. When timing is complete, the output relay re-energizes automatically. The yellow LED glows when the output relay is energized.

CM-PVE

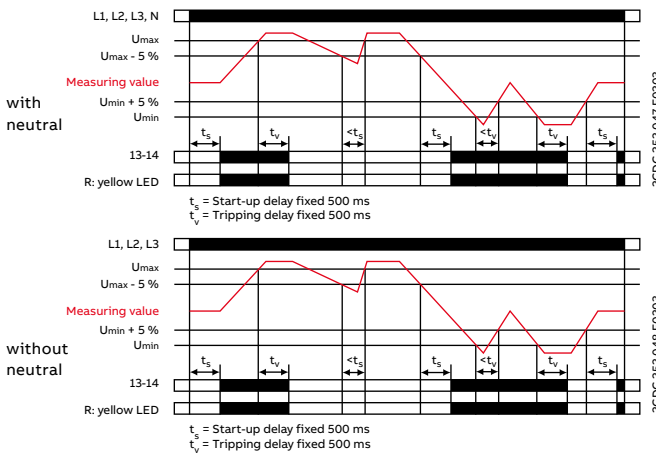

Phase failure, under- / overvoltage detection

If all phases (and the neutral) are present with correct voltage, the output relay energizes after the start-up delay t_s is complete. If the voltage exceeds or falls below the fixed threshold value or if a phase failure occurs, the tripping delay t_v starts. When timing is complete, the output relay de-energizes. As soon as the voltage returns to the tolerance range, timing of t_s starts. When timing is complete, the output relay re-energizes automatically. The yellow LED glows when the output relay is energized.

CM-PFE, CM-PFE.2

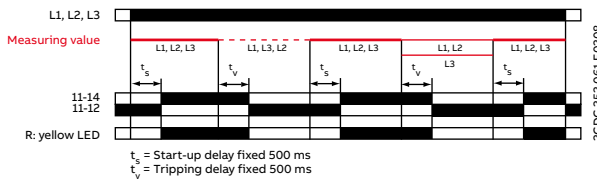

Phase failure detection, phase sequence monitoring

If all phases are present with the correct phase sequence, the output relay energizes after the start-up delay t_s is complete. If a phase failure or a phase sequence error occurs, the tripping delay t_v starts. When timing is complete, the output relay de-energizes. The yellow LED glows when the output relay is energized.

In case of motors which continue running with only two phases, the CM-PFE detects phase failure if the reverse fed voltage is less than 60 % of the originally applied voltage.

CM-PFS

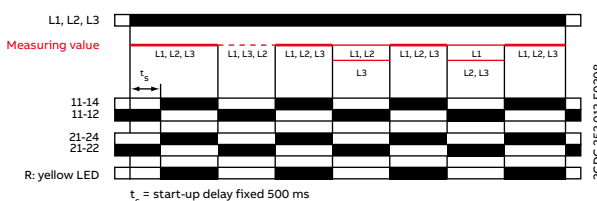

Phase failure detection, phase sequence monitoring

If all phases are present with the correct phase sequence, the output relay energizes after the start-up delay t_s is complete. If a phase failure or a phase sequence error occurs, the output relay de-energizes instantaneous. The yellow LED glows when the output relay is energized.

In case of motors which continue running with only two phases, the CM-PFS detects phase failure if the reverse fed voltage is less than 60 % of the originally applied voltage.

ATTENTION

If several CM-PFS units are placed side by side and the control supply voltage is higher than 415 V, spacing of at least 10 mm has to be kept between the individual units.

Three-phase monitoring relays

Function diagrams

CM-PSS.xx, CM-PVS.xx, CM.PAS.xx, CM-MPS.xx, CM-MPN.xx

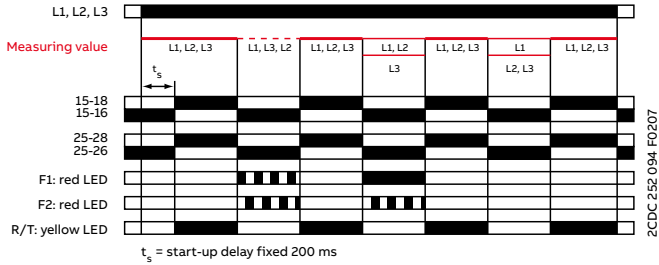

Phase sequence monitoring and phase failure detection

Applying control supply voltage begins the fixed start-up delay t_s . When t_s is complete and all phases are present with correct voltage, the output relays energize and the yellow LED R/T glows.

Phase sequence monitoring

If phase sequence monitoring is activated, the output relays de-energize as soon as a phase sequence error occurs. The fault is displayed by alternated flashing of the LEDs F1 and F2. The output relays re-energize automatically as soon as the phase sequence is correct again.

Phase failure detection

The output relays de-energize instantaneous if a phase failure occurs. The fault is indicated by lighting of LED F1 and flashing of LED F2. The output relays re-energize automatically as soon as the voltage returns to the tolerance range.

CM-MPS.11, CM-MPS.21, CM-MPS.23

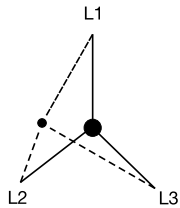

Displacement of the star point

Interrupted neutral monitoring

The interruption of the neutral in the main to be monitored is detected by means of phase unbalance evaluation. Determined by the system, in case of unloaded neutral (i.e. symmetrical load between all three phases) it may happen that an interruption of the neutral will not be detected. If the star point is displaced an asymmetrical load in the three-phase main, an interrupted neutral will be detected.

Three-phase monitoring relays

Function diagrams

CM-MPS.x3, CM-MPN.x2

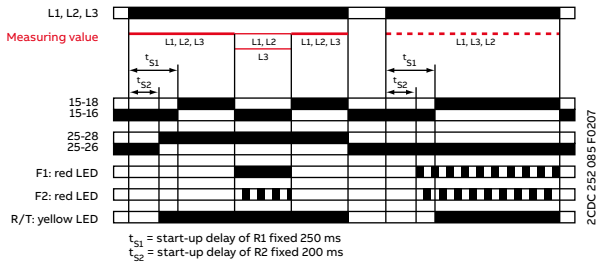

Automatic phase sequence correction

This function can be selected only if phase sequence monitoring is activated and operating mode 2x1 c/o (SPDT) contact is selected.

Applying control supply voltage begins the fixed start-up delay t_{s1} . When t_{s1} is complete and all phases are present with correct voltage, output relay R1 energizes. Output relay R2 energizes when the fixed start-up delay t_{s2} is complete and all phases are present with the correct phase sequence. Output relay R2 remains de-energized if the phase sequence is incorrect.

If the voltage to be monitored exceeds or falls below the set threshold values for phase unbalance, over- or undervoltage or if a phase failure occurs, output relay R1 de-energizes and the LEDs F1 and F2 indicate the fault. Output relay R2 is responsive only to a false phase sequence. In conjunction with a reversing contactor combination, this enables an automatic correction of the rotation direction. See circuit diagrams on this page.

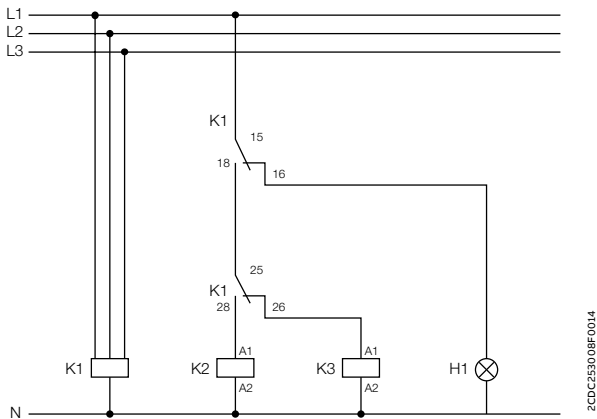

Control circuit diagram (K1 = CM-MPS.23)

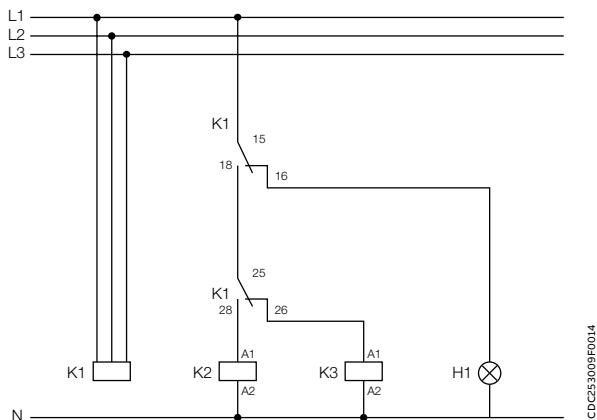

Control circuit diagram (K1 = CM-MPS.43 or CM-MPN.xx)

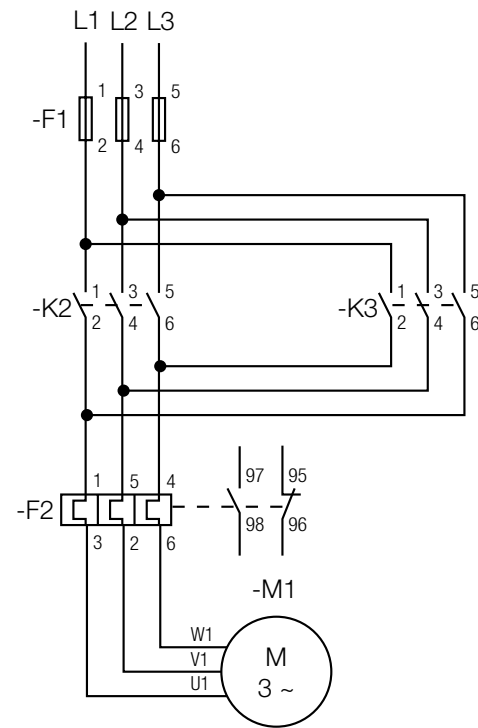

Power circuit diagram

Three-phase monitoring relays

Function diagrams

CM-PSS.xx (1), CM-PVS.xx (2), CM-MPS.xx (2), CM-MPN.xx (2)

ON-delay ☒, 1x2 c/o contacts [1x2 c/o]

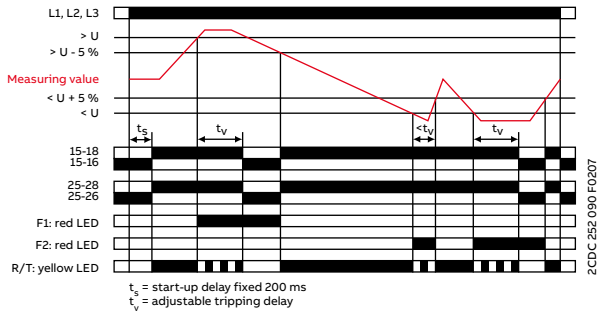

Over- and undervoltage monitoring [1x2 c/o]

Applying control supply voltage begins the fixed start-up delay t_s . When t_s is complete and all phases are present with correct voltage and with the correct phase sequence, the output relays energize and the yellow LED R/T glows.

Type of tripping delay = ON-delay

If the voltage to be monitored exceeds or falls below the fixed (1) or set (2) threshold value, the output relays de-energize after the set tripping delay t_v is complete. The LED R/T flashes during timing and turns off as soon as the output relays de-energize.

The output relays re-energize automatically as soon as the voltage returns to the tolerance range, taking into account a fixed hysteresis of 5 % and the LED R/T glows.

OFF-delay ■, 1x2 c/o contacts [1x2 c/o]

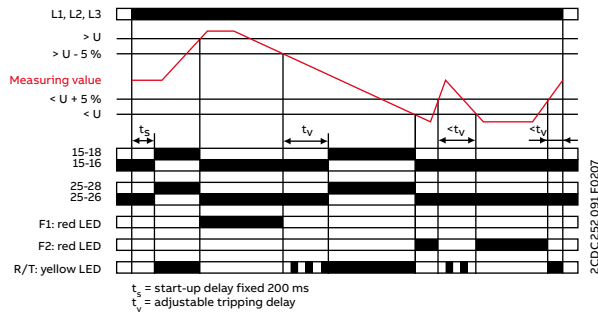

Type of tripping delay = OFF-delay

If the voltage to be monitored exceeds or falls below the fixed (1) or set (2) threshold value, the output relays de-energize instantaneously and the LED R/T turns off. As soon as the voltage returns to the tolerance range, taking into account a fixed hysteresis of 5 %, the output relays re-energize automatically after the set tripping delay t_v is complete. The LED R/T flashes during timing and turns steady when timing is complete.

Three-phase monitoring relays

Function diagrams

CM-MPS.x3, CM-MPN.x2

ON-delay , 2x1 c/o contact

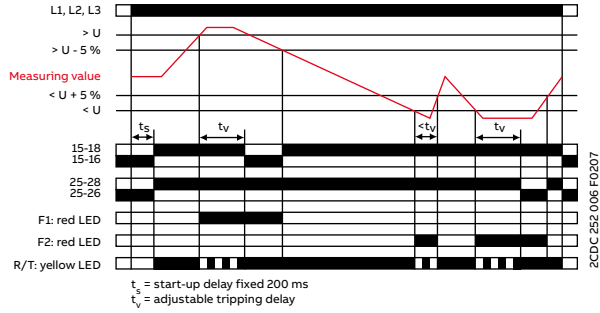

Over- and undervoltage monitoring

Applying control supply voltage begins the fixed start-up delay t_s . When t_s is complete and all phases are present with correct voltage and with the correct phase sequence, the output relays energize. The yellow LED R/T glows as long as at least one output relay is energized.

Type of tripping delay = ON-delay

If the voltage to be monitored exceeds or falls below the set threshold value, output relay R1 (overvoltage) or output relay R2 (undervoltage) de-energizes after the set tripping delay t_v is complete. The LED R/T flashes during timing.

The corresponding output relay re-energizes automatically as soon as the voltage returns to the tolerance range, taking into account a fixed hysteresis of 5 %.

OFF-delay , 2x1 c/o contact

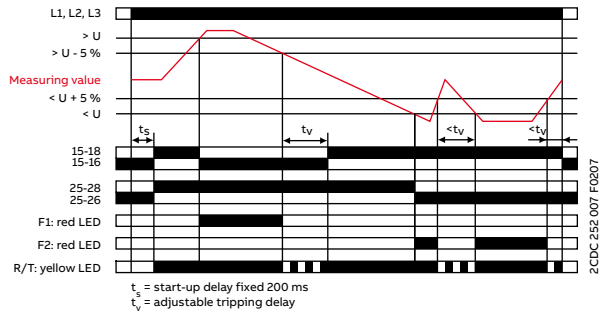

Type of tripping delay = OFF-delay

If the voltage to be monitored exceeds or falls below the set threshold value, output relay R1 (overvoltage) or output relay R2 (undervoltage) de-energizes instantaneously.

As soon as the voltage returns to the tolerance range, taking into account a fixed hysteresis of 5 %, the corresponding output relay re-energizes automatically after the set tripping delay t_v is complete. The LED R/T flashes during timing.

Three-phase monitoring relays

Function diagrams

CM-PAS.xx, CM-MPS.xx, CM-MPN.xx

ON-delay ☒

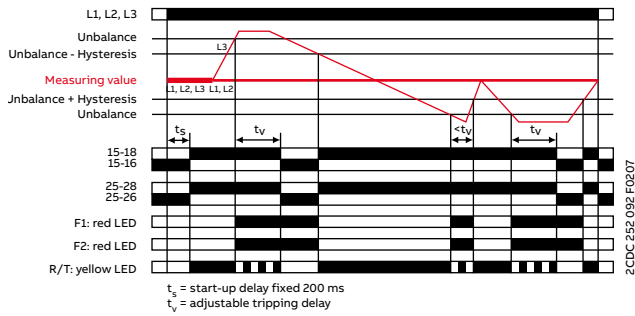

ZCDC 252 092 F0207

OFF-delay ■

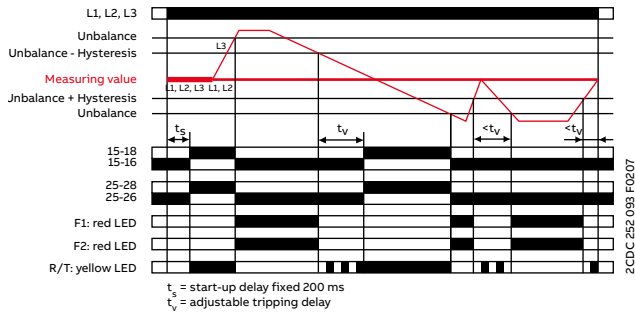

ZCDC 252 093 F0207

Phase unbalance monitoring

Applying control supply voltage begins the fixed start-up delay t_s . When t_s is complete and all phases are present with correct voltage and with the correct phase sequence, the output relays energize and the yellow LED R/T glows.

Type of tripping delay = ON-delay

If the voltage to be monitored exceeds or falls below the set phase unbalance threshold value, the output relays de-energize after the set tripping delay t_v is complete. The LED R/T flashes during timing and turns off as soon as the output relays de-energize.

The output relays re-energize automatically as soon as the voltage returns to the tolerance range, taking into account a fixed hysteresis of 20 % and the LED R/T glows.

Type of tripping delay = OFF-delay

If the voltage to be monitored exceeds or falls below the set phase unbalance threshold value, the output relays de-energize instantaneously and the LED R/T turns off. As soon as the voltage returns to the tolerance range, taking into account a fixed hysteresis of 20 %, the output relays re-energize automatically after the set tripping delay t_v is complete. The LED R/T flashes during timing and turns steady when timing is complete.

Three-phase monitoring relays

Function diagrams

CM-PSS.xx, CM-PSV.xx, CM-PAS.xx, CM-MPS.xx, CM-MPN.xx

LED functions

Function	R/T: yellow LED	F1: red LED	F2: red LED
Control supply voltage applied, output relay energized		-	-
Tripping delay t _v active		-	-
Phase failure	-		
Phase sequence	-	alternating	
Overvoltage	-		-
Undervoltage	-	-	
Phase unbalance	-		
Interruption of the neutral	-		
Adjustment error			

Possible wrong adjustments of the front-facing operating controls

Overlapping of the threshold values:

- An overlapping of the threshold values is given if the threshold value for overvoltage is set to a smaller value than the threshold value for undervoltage.
- DIP switch 3 = OFF
- DIP switch 4 = ON: Automatic phase sequence correction is activated and selected operating mode is 1x2 c/o contacts
- DIP switch 2 and 4 = ON: Phase sequence detection is deactivated and the automatic phase sequence correction is activated

Type of tripping delay

The type of tripping delay / can be adjusted via a rotary (CM-PxS.xx) or a DIP switch (CM-MPx.xx).

Switch position ON-delay :

In case of a fault, the de-energizing of the output relays and the respective fault message are suppressed for the adjusted tripping delay t_v.

Switch position OFF-delay :

In case of a fault, the output relays de-energize instantaneously and a fault message is displayed and stored for the length of the adjusted tripping delay t_v. Thereby, also momentary undervoltage conditions are recognized.



Grid feeding monitoring relays

Table of contents

138	Benefits and advantages
143	Operating controls
144	Selection table
145	Ordering details
146	Technical data
147	Technical diagrams

Grid feeding monitoring relays

Benefits and advantages



ABB's grid feeding monitoring relays detect unusual events in the public power grid and keeps it stable by automatically disconnecting and reconnecting the renewable power plant. The CM-UFD displays all relevant measuring data and events and can communicate them via a build-in communication interface. The cloud-based service Ability™ EDCS enables customers to monitor the conditions in real-time, send the values into the cloud and access the diagnostics remotely.



Optimum interface

Reduce downtime by up to 70%

Operate the device via LCD or remotely with the Modbus RTU. Users are informed immediately in case of an event in the public grid. Redundant microcontrollers ensure reliable measuring values and tripping.



Global availability

Cut installation time by up to 60%

There's no need to learn every possible adjustment and its effects on your system – ABB's trained staff supports your business and answers your technical questions promptly.



Easy installation

Commission & configure up to 60% faster

Simple instructions, presets for local grid feeding standards, and ABB's intuitive menu structure make installation quicker. Commissioning and troubleshooting errors are prevented.

Grid feeding monitoring relays

Benefits and advantages



ABB's CM-UFD range are multi-functional grid feeding monitoring relays, installed between the renewable energy system and the public grid. The innovative relays guarantee grid stability and prevent blackouts. If the public grid's voltage or frequency moves out of the permitted ranges, the device uses a decoupling unit (e.g. contactor or breaker Tmax XT) to separate the renewable energy system from the public grid. As soon as the grid is stable again, the system is automatically reconnected.

The CM-UFD range provides different monitoring functions in accordance with several local grid feeding standards to detect over-/undervoltage and over-/underfrequency.

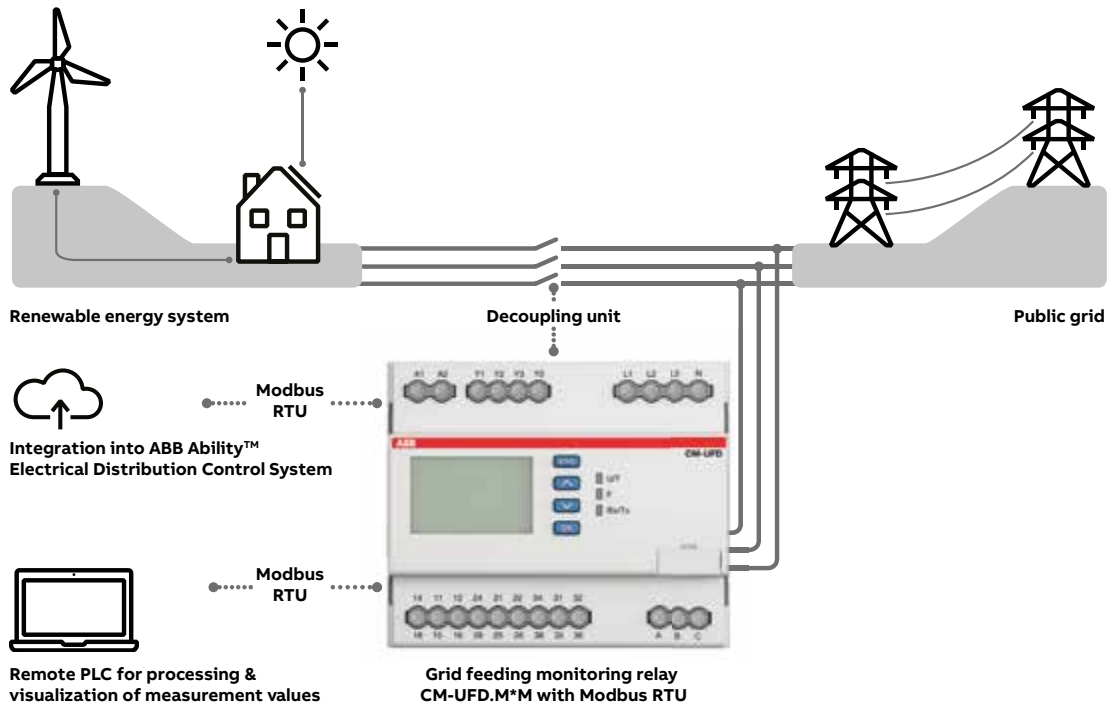

Advantages

- Highly accurate measurement and setting
- Modbus RTU communication interface and ABB Ability™ EDCS connectivity
- Functional safety - single fault tolerances
- Clear multiline, backlit LCD
- Intuitive and user-friendly menu
- Event storage
- Pre-settings meet several local standards
- Type-tested to a number of local grid feeding standards by TÜV Süd



Functionality

The device measures the ten-minute average value, voltage increases and decreases, as well as any changes in grid frequency. The rate of change of frequency (ROCOF) and vector shift monitoring to detect a loss of mains event can be easily configured.

ABB ABILITY™ EDCS

Monitor your renewable energy plant remotely with ABB's smart ABB Ability™ EDCS cloud platform.



Grid feeding monitoring relays

Benefits and advantages

The cloud-based service Ability™ EDCS enables customers to monitor the condition of CM-UFD.M*M in real-time and access the diagnostics remotely. This functionality is very important when operating in the field of critical power. Parametrize with ABB Ekip Connect and access data no matter where you are.

Example architecture

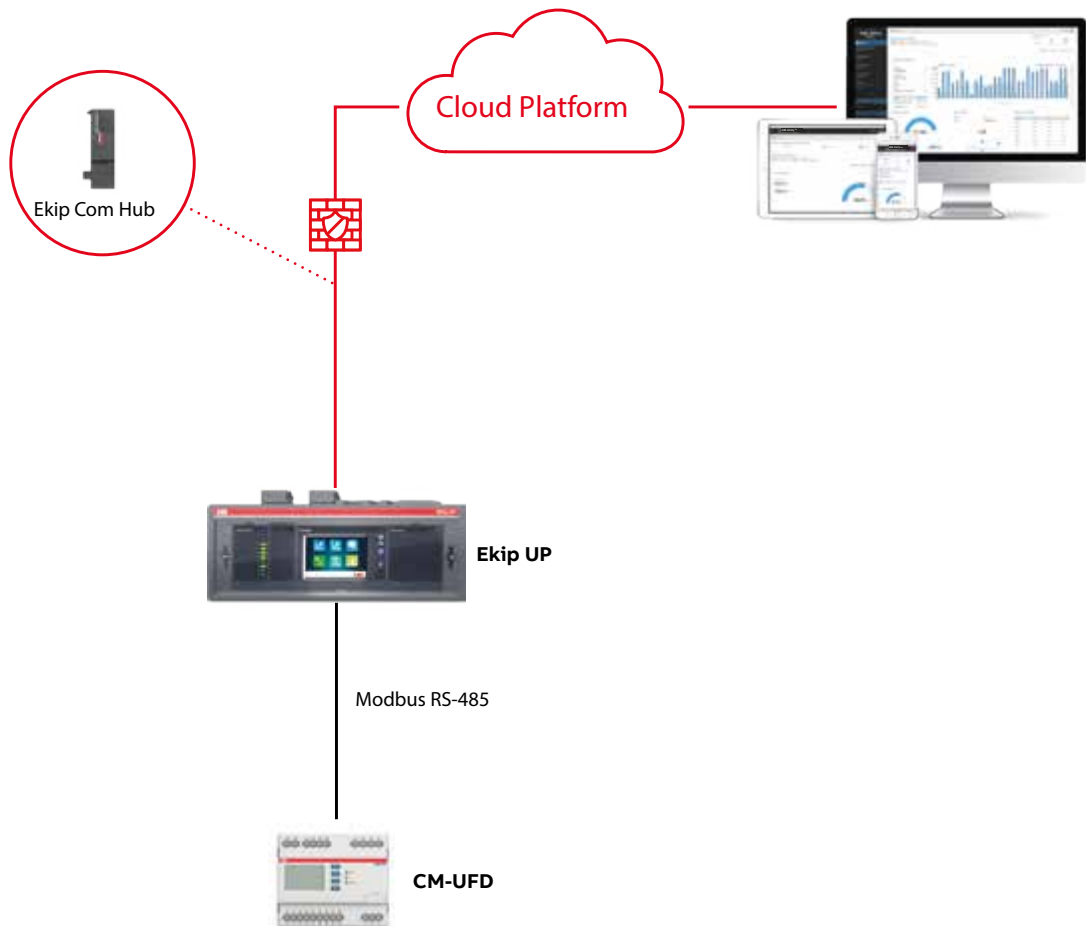

The grid feeding monitoring relays can be connected to the cloud directly by using Ekip Com Hub module. Another option is to connect via Modbus RTU when there is some other device equipped with the Ekip Com Hub like the Emax 2 air-circuit breaker.

In addition to the Ekip Connect 3 software, the following hardware is required:

- Ekip UP (min. firmware 2.23)
- Ekip Com Hub (min. firmware 1.18)
- Ekip Com Modbus RTU (min. firmware 2.28)
- Ekip Supply
- Ekip T&P cable
- CM-UFD.M*M (min. firmware 1.0.1)



For further information regarding integration into ABB Ability™ EDCS, please use the application note "2CDC112280M0101 CM-UFD.M*M integration into ABB Ability™ EDCS".

Grid feeding monitoring relays

Benefits and advantages

A reliable solution that takes country-specific requirements into account: the range is already pre-set to local requirements, making installation quick and simple. The devices can also be set manually with the display and used all over the world.



Pre-set devices

In accordance with a number of local standards, the CM-UFD relays can be used in all low voltage plants and in medium voltage plants.



Type-tested

To ensure reliability and compliance, the range is type-tested to local standards by the third party authority TÜV Süd.

— Countries with a dedicated local standard (in red)

— Countries referring to an existing local standard or using a product with reference to another dedicated standard (in grey)

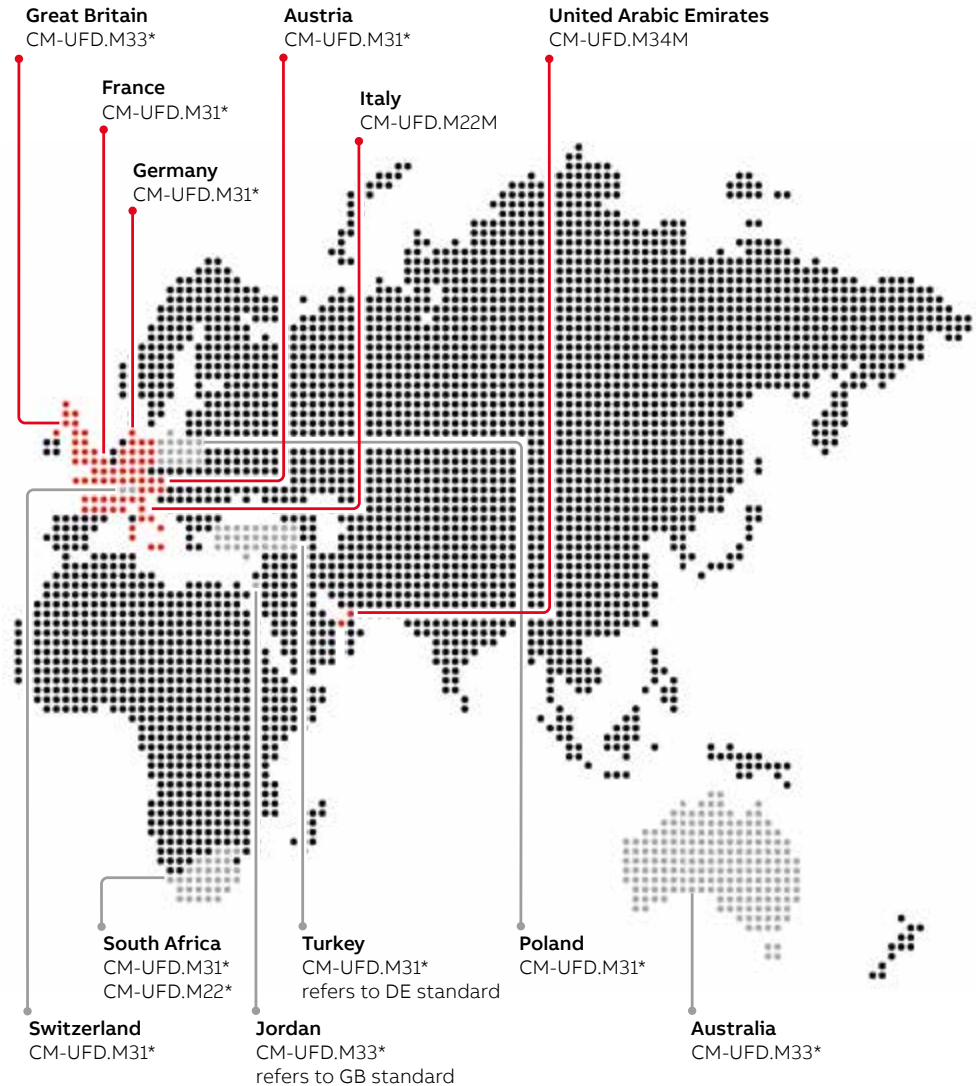

Grid feeding monitoring relays

Operating controls

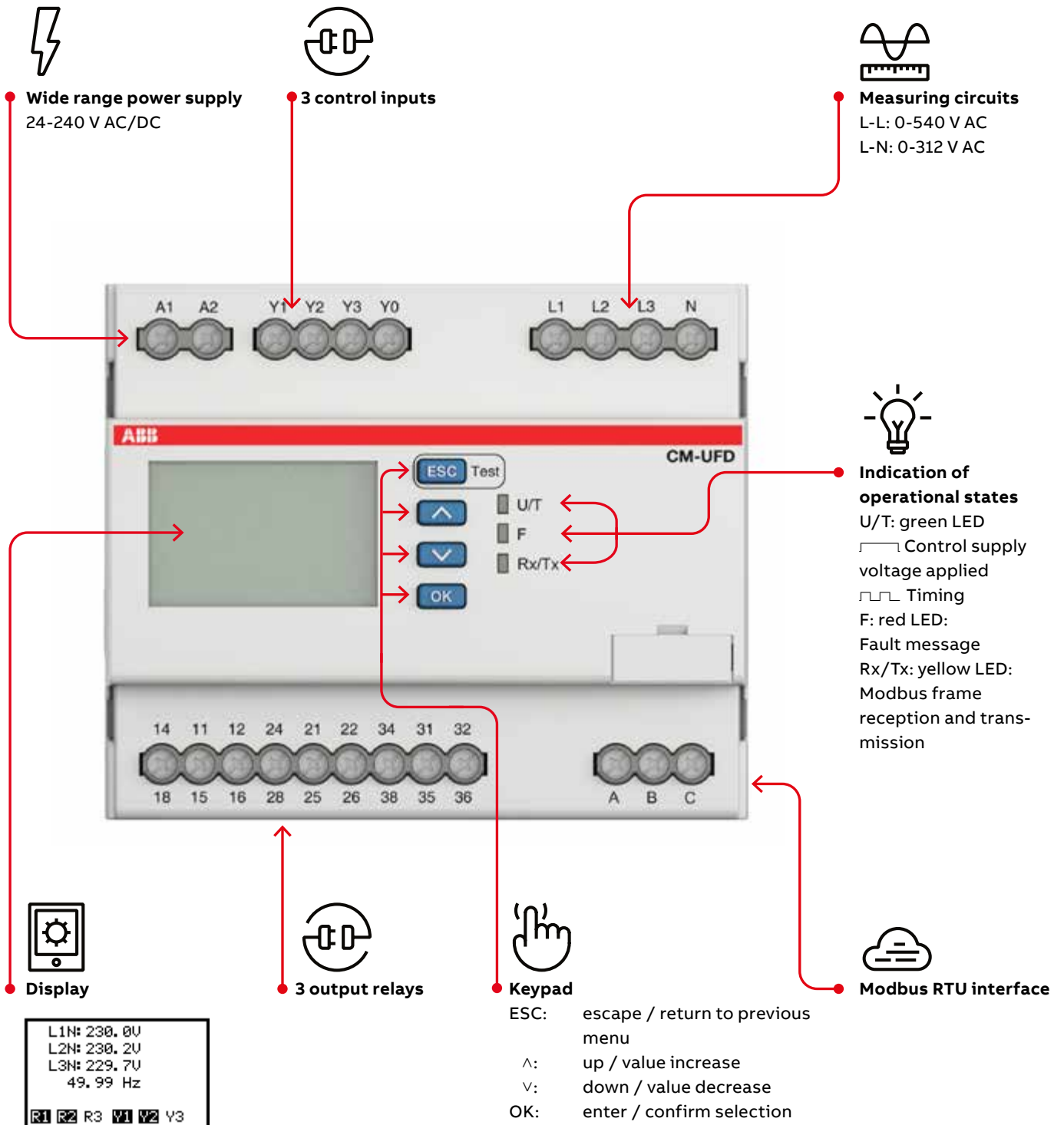

Grid feeding monitoring relays

Selection table

	Type	Order number					
	CM-UFD.M22M	1SVR560731R3700					
	CM-UFD.M31	1SVR560730R3401					
	CM-UFD.M31M	1SVR560731R3701					
	CM-UFD.M33	1SVR560730R3402					
	CM-UFD.M33M	1SVR560731R3702					
	CM-UFD.M34M	1SVR560731R3703					
Rated control supply voltage U_c							
24-240 V AC/DC			■	■	■	■	■
Standard							
CEI 0-21			■				
VDE AR-N 4105, VDE AR-N 4110, VDE AR-N 4120				■	■		
ENA G98, G99						■	■
DRRG standard of DEWA							■
Rated frequency							
DC or 50/60 Hz			■	■	■	■	■
Modbus RTU							
			■			■	■
Suitable for monitoring							
Single-phase mains			■	■	■	■	■
Three-phase mains			■	■	■	■	■
Monitoring function							
Over-/undervoltage			■	■	■	■	■
Over-/underfrequency			■	■	■	■	■
ROCOF (rate of change of frequency)			■	■	■	■	■
10 minutes average value			■	■	■	■	■
Vector shift			■	■	■	■	■
Thresholds							
			adj	adj	adj	adj	adj

Grid feeding monitoring relays

Ordering details



CM-UFD.M*M

2CDC25100350017

Description

The grid feeding monitoring relays CM-UFD.M*M are designed to monitor the voltage and the frequency of the public low voltage or medium voltage grid. Whenever the measured values are not within the range of the adjusted threshold values, the CM-UFD.M*M causes tripping of the section switch (consisting of 1 or 2 switching devices according to the applicable standard). This tripping disconnects the power generation, such as photovoltaic systems, wind turbines, block-type thermal power stations from the grid.

Ordering details

Description	Type	Order code	Weight (1 pc) kg (lb)
See selection table	CM-UFD.M22M	1SVR560731R3700	0.312 (0.688)
	CM-UFD.M31	1SVR560730R3401	0.304 (0.670)
	CM-UFD.M31M	1SVR560731R3701	0.312 (0.688)
	CM-UFD.M33	1SVR560730R3402	0.304 (0.670)
	CM-UFD.M33M	1SVR560731R3702	0.312 (0.688)
	CM-UFD.M34M	1SVR560731R3703	0.312 (0.688)

Grid feeding monitoring relays

Technical data



Data sheets

For every product of the CM-UFD range, a technical data sheet is available.

- Operating control and mode
- Operating principles
- Modbus RTU functionality where available
- Electrical connection
- Configuration and settings
- Menu structure
- Display and failure messages
- Connection and wiring
- Technical data
- Technical diagrams
- CAS system files

Ordering data and data sheet numbers

Description	Type	Order code	Data sheet number
	CM-UFD.M22M	1SVR560731R3700	2CDC112258D0201
	CM-UFD.M31	1SVR560730R3401	2CDC112208D0201
	CM-UFD.M31M	1SVR560731R3701	2CDC112270D0201
	CM-UFD.M33	1SVR560730R3402	2CDC112210D0201
	CM-UFD.M33M	1SVR560731R3702	2CDC112271D0201
	CM-UFD.M34M	1SVR560731R3703	2CDC112272D0201



For further information regarding integration into ABB Ability™ EDCS, please use the application note "2CDC112280M0101 CM-UFD.M*M integration into ABB Ability™ EDCS".

Grid feeding monitoring relays

Technical diagrams

Example of a single-phase application

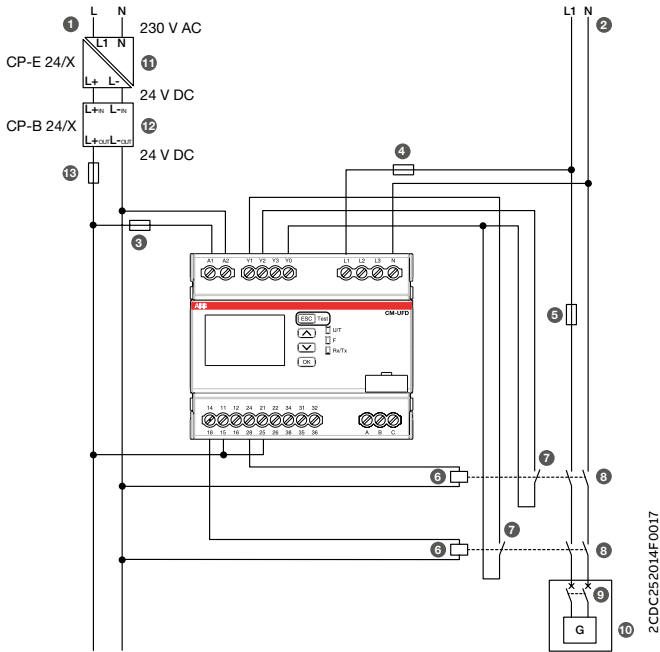

Example of a three-phase application

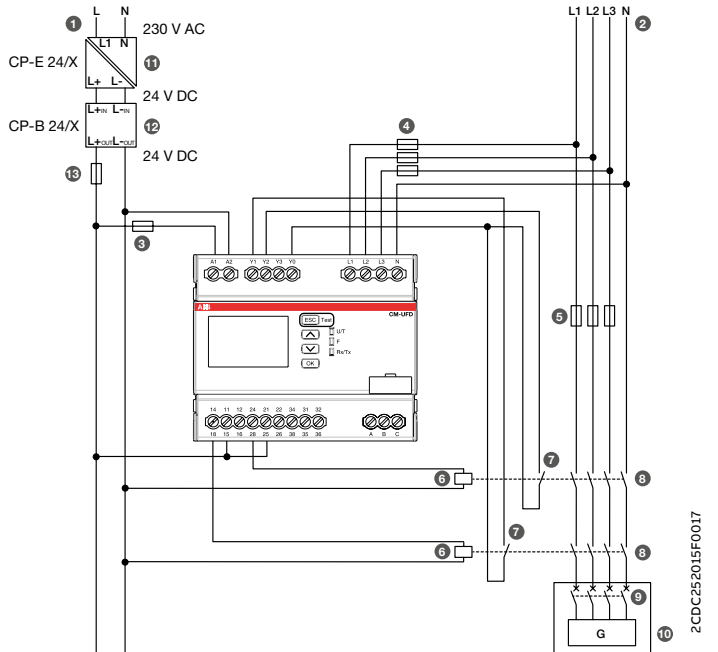

Legend

1. Control supply voltage for CM-UFD.M*M
2. Public grid
3. Protection fuse for the CM-UFD.M*M
4. Protection fuse for the measuring circuit of the CM-UFD.M*M (optional)
5. Short-circuit protection
6. Undervoltage release
7. Control input for feedback function
8. Switching device of the section switch
9. Switching device of the generator and/or inverter
10. Generator and/or inverter
11. Primary switch mode power supply unit CP-E (230 V AC / 24 V DC) for the buffer module CP-B
12. Ultra-capacitor based buffer module CP-B (24 V DC in/out)
13. Wire protection fuse for the output of the buffer module CP-B

Grid feeding monitoring relays

Technical diagrams

Load limits curves

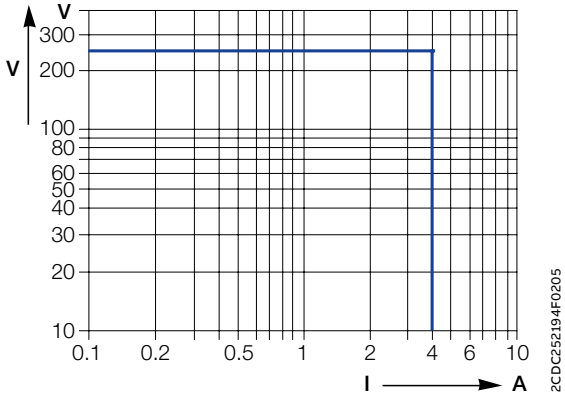

AC load (resistive)

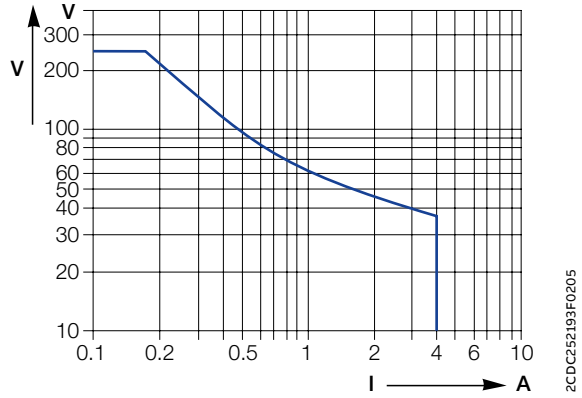

DC load (resistive)

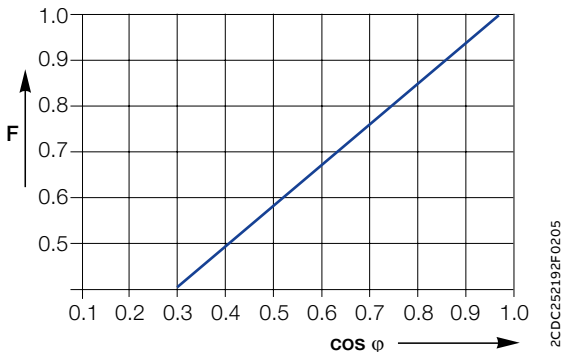

Derating factor F at inductive AC load

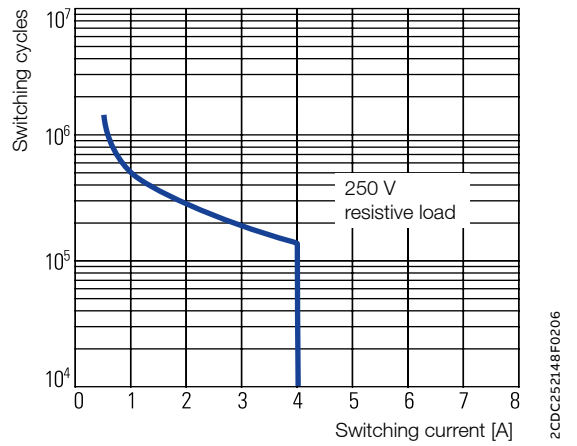

Contact lifetime

Dimensional drawings in mm and inches

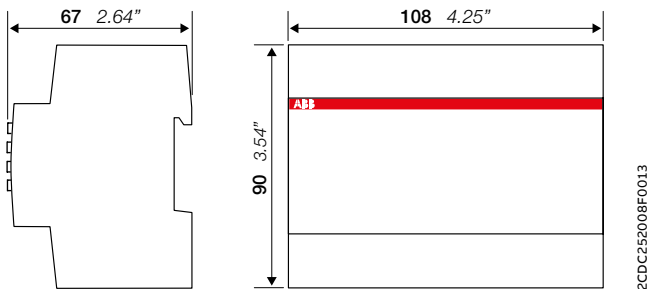



Insulation monitoring relays for unearthed supply systems

Table of contents

152	Benefits and advantages
156	Applications
157	Operating controls
160	Selection table
161	Ordering details
162	Technical data
169	Technical diagrams

Insulation monitoring relays

Benefits and advantages



The insulation monitoring relays of the CM-IWx range guarantee a continuous insulation monitoring of an IT system. The devices recognize insulation faults as they develop and warn immediately if the value has fallen below the minimum set threshold. This ensures a reliable operation of the system and prevents operational interruption caused by a second, more severe, insulation fault which may lead to a short circuit tripping the main circuit breaker.



Continuous operation

Keep the system online and reduce downtime with early pre-warnings which enable time for maintenance planning. Monitor voltage free networks for early fault detection. Due to variants with rail and ship approval, the devices have a wide range of applications.



Safety and protection

Safe and reliable detection of insulation faults according to the latest standards is what ABB's insulation monitoring relays deliver. The portfolio extends from standard to more challenging applications and can prevent fire due to fast and reliable earth fault detection. Built-in self-diagnosis and interrupted wire detection further ensure safety.



Easy installation

Read the status of the relay at a glance: clear visualization of the device status via LEDs. Easy to adjust with rotary wheels and variants with push-in terminals make a quick and easy installation and setting possible.

Insulation monitoring relays

Benefits and advantages



Overview

The CM-IWx product family offers a convincing solution for monitoring ungrounded AC, AC/DC and DC networks according to EN/IEC 61557-8. An IT network is supplied either by an isolating transformer or a voltage source, such as a battery or generator. In these systems, no active conductor is directly connected to earth potential.

The high reliability of an IT system is guaranteed thanks to continuous insulation monitoring. The insulation monitoring device recognizes insulation faults (at least one conductor has a galvanic connection to earth potential) as they develop and immediately reports if the insulation resistance has fallen below a given threshold. Therefore, maintenance activities can be scheduled and executed while the plant keeps running.



Main benefits

- Increase plant availability and avoid costly unplanned stops of a plant / machine by quickly detecting faults first
- Prevents fires due to detection of a creeping deterioration of the insulation resistance
- The adjustment of the setting values is simple and done in a user-friendly way with rotary switches on the front of the device
- Device status is displayed with LEDs that are easy to read and understand
- Devices for standard and more challenging applications are available
- Variants with rail and ship approvals are available



Insulation monitoring relays

Benefits and advantages

CM-IWS.1 – for unearthed AC, DC or mixed AC/DC systems



The CM-IWS.1 serves to monitor insulation resistance in accordance with IEC 61557-8 in unearthed IT AC systems, IT AC systems with galvanically connected DC circuits, or unearthed IT DC systems with a voltage up to 250 V AC and 300 V DC. It can be configured to the requirements of the applications and therefore has multi-functional uses. The device is available with two different terminal versions. You can choose between the proven screw connection technology (double-chamber cage connection terminals) and the completely tool-free Easy Connect Technology (push-in terminals).

- For monitoring the insulation resistance of unearthed IT systems up to $U_n = 250$ V AC and 300 V DC
- Test function
- According to IEC/EN 61557-8
- Rated control supply voltage 24–240 V AC/DC
- Prognostic measuring principle with superimposed square wave signal
- One measuring range 1–100 k Ω
- 1 c/o (SPDT) contact, closed-circuit principle
- Precise adjustment by front-face operating controls in 1 k Ω steps
- Interrupted wire detection
- Fault storage / latching configurable by control input
- Screw connection or Easy Connect Technology available
- Housing material for highest fire protection classification UL 94 V-0
- Tool-free mounting on DIN rail as well as demounting
- 22.5 mm width
- 3 LEDs for status indication

CM-IWS.2 – for unearthed pure AC systems



The CM-IWS.2 serves to monitor insulation resistance in accordance with IEC 61557-8 in unearthed IT AC systems with a voltage up to 400 V AC. The CM-IWS.2 can be configured to the requirements of the applications and therefore has multi-functional uses. The device is available with two different terminal versions. You can choose between the proven screw connection technology (double-chamber cage connection terminals) and the completely tool-free Easy Connect Technology (push-in terminals).

- For monitoring the insulation resistance of unearthed IT systems up to $U_n = 400$ V AC
- Test function
- According to IEC/EN 61557-8
- Rated control supply voltage 24–240 V AC/DC
- Measuring principle with superimposed DC voltage
- One measuring range 1–100 k Ω
- Fault storage / latching configurable by control input
- Precise adjustment by front-face operating controls in 1 k Ω steps
- Screw connection or Easy Connect Technology available
- Housing material for highest fire protection classification UL 94 V-0
- Tool-free mounting on DIN rail as well as demounting
- 1 c/o (SPDT) contact, closed-circuit principle
- 22.5 mm width
- 3 LEDs for status indication

Insulation monitoring relays

Benefits and advantages

CM-IWN.1 – for unearthed AC, DC or mixed AC/DC systems



The CM-IWN.1 serves to monitor insulation resistance in accordance with IEC 61557-8 in unearthed IT AC systems, IT AC systems with galvanically connected DC circuits, or unearthed IT DC systems with a voltage up to 400 V AC and 600 V DC. The measuring range can be extended up to 690 V AC and 1000 V DC by using the coupling unit CM-IVN. It can be configured to the requirements of the applications and therefore has multi-functional uses. The CM-IWN.1 is available with two different terminal versions. You can choose between the proven screw connection technology (double chamber cage connection terminals) and the completely tool-free Easy Connect Technology (push-in terminals).

- For monitoring the insulation resistance of unearthed IT systems up to $U_n = 400$ V AC and 600 V DC, expansion to 690 V AC and 1000 V DC with CM-IVN
- Test function
- According to IEC/EN 61557-8
- Rated control supply voltage 24-240 V AC/DC
- Prognostic measuring principle with superimposed square wave signal
- Two measuring ranges 1-100 k Ω and 2-200 k Ω
- Precise adjustment of the measuring value in 1 or 2 kW steps
- One (1 x 2 c/o) or two (2 x 1 c/o) threshold values R_{an1}/R_1 (warning) and R_{an2}/R_2 (pre-warning) configurable
- Precise adjustment of the threshold values in 1 k Ω steps (R1) and 2 k Ω steps (R2)
- Interrupted wire detection configurable
- Non-volatile fault storage configurable
- Open- or closed-circuit principle configurable
- Screw connection or Easy Connect Technology available
- Housing material for highest fire protection classification UL 94 V-0
- Tool-free mounting on DIN rail as well as demounting
- 45 mm width
- 3 LEDs for status indication

CM-IWM.10 and CM-IWM.11 – for unearthed AC, DC or mixed AC/DC systems with up to 1500 V measurement voltage



The insulation monitors CM-IWM.10 and CM-IWM.11 provide the best and up-to-date insulation monitoring of modern IT systems in an optimum and state-of-the-art way fulfilling the relevant standards. The devices can be used in the most flexible way for AC, DC and AC/DC systems even with large leakage capacity to earth (PE). The adjustment of the setting values is simple and done in a user-friendly way on two rotary switches on the front of the device. Via LEDs the measured value, device parameters and device status are indicated easy to read.

- Insulation monitoring according to IEC/EN 61557-8
- Detection of symmetric and asymmetric insulation faults
- 1 c/o contact each for pre-warning and warning
- Measuring circuits can be disconnected via control terminals, e.g. for mains couplings
- Pre-warning threshold setting range: 20 k Ω ... 2 M Ω
- Warning threshold setting range: 1 k Ω ... 250 k Ω
- Open- or closed-circuit principle configurable
- Setting the maximum earth leakage capacitance to shorten the response time
- Simple, clearly arranged adjustment of the device with screwdriver
- LED chain to indicate the current insulation resistance
- Display of active measuring circuits
- Automatic and manual device self-test
- Alarm storage selectable
- External test and reset push button can be connected
- 90 mm width

Insulation monitoring relays

Applications

The CM-IWS.x and CM-IWN.x series provide excellent insulation monitoring for general purpose supply networks, such as:

- Non-earthed AC, DC, AC/DC networks
- UPS systems
- Battery networks
- Hybrid and battery-powered vehicles
- Railway applications

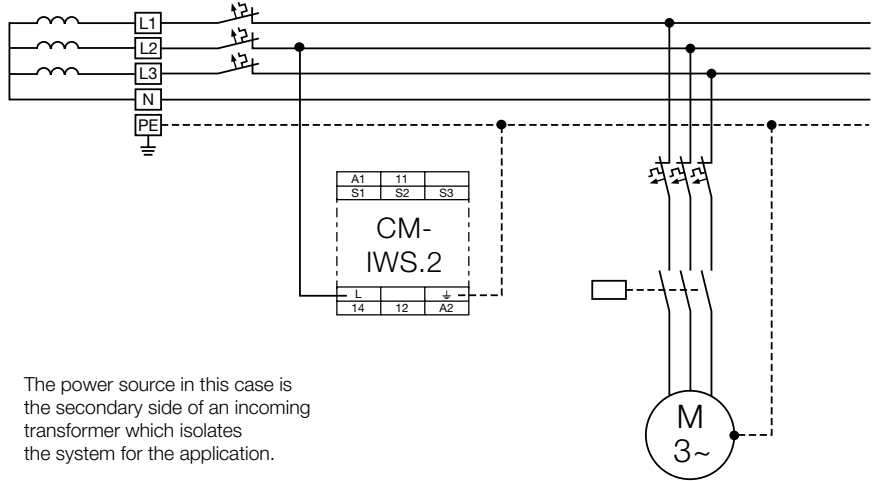

The power source in this case is the secondary side of an incoming transformer which isolates the system for the application.

Earth fault / insulation resistance monitoring of a 4-wire IT AC system with CM-IWS.2

CM-IWM.x can be additionally used in special applications, such as:

- Industrial networks with frequency inverters or direct current drives
- Photovoltaic systems with high system leakage capacitance
- Networks with system voltages up to 1500 V DC or 1100 V AC without requiring a coupling unit
- Installation on the AC or DC side of an inverter
- Networks which require measuring circuit deactivation in case two or more un-earthed networks are coupled

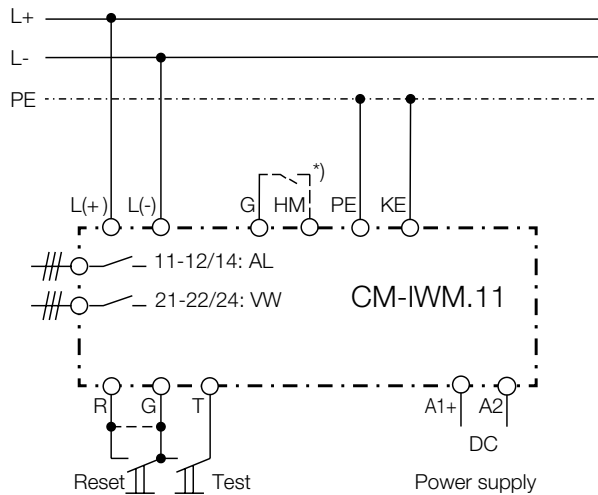

*) G-HM connected: Measuring circuit is off

Example of a DC application with CM-IWM.11

Note:
Only one insulation monitor must be connected and active in a network at the same time.

Insulation monitoring relays

Operating controls

CM-IWM

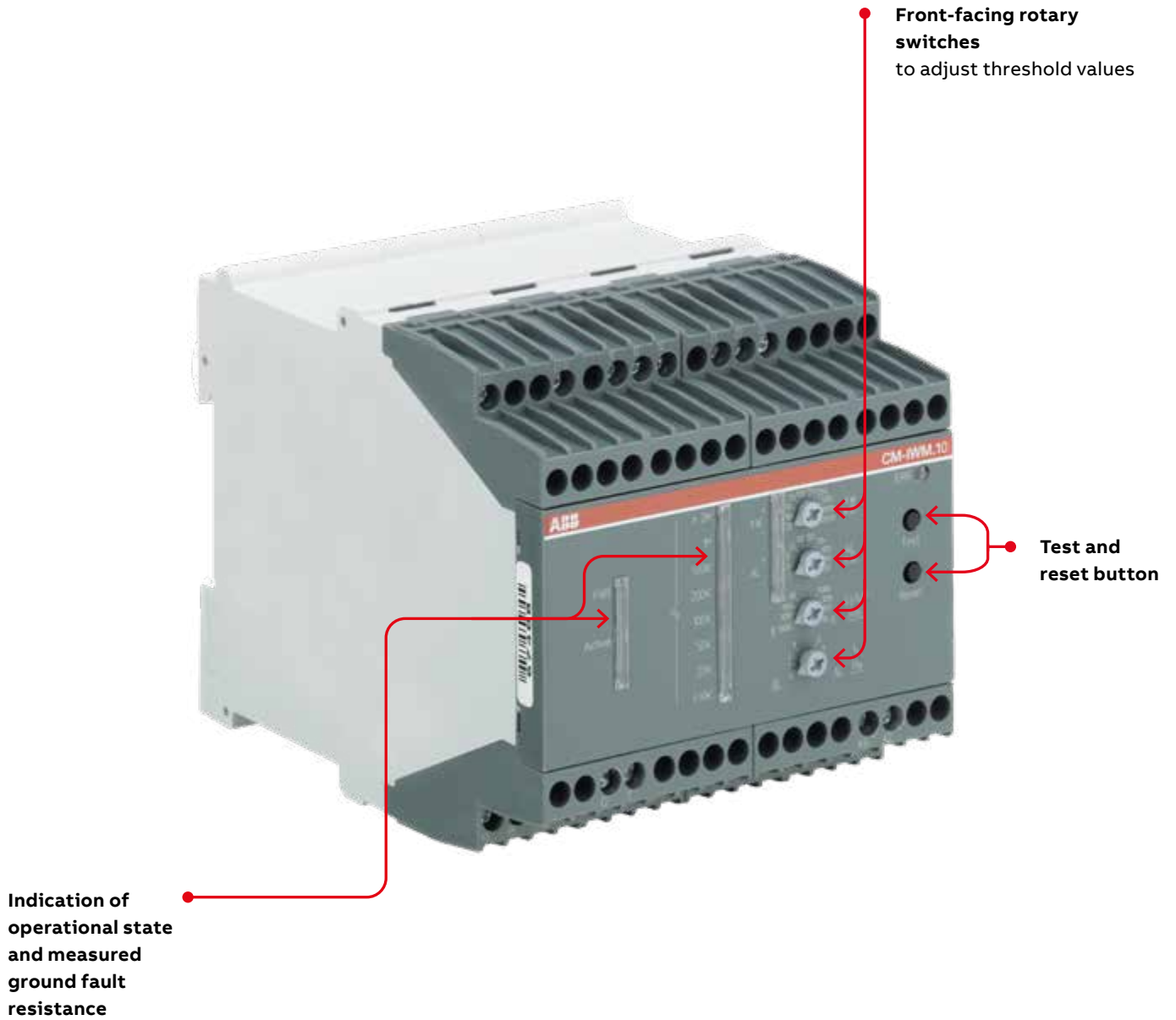

Insulation monitoring relays

Operating controls

CM-IWS



Test and reset button

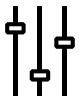

Configuration and setting
Front-face rotary switches for threshold value adjustment:

- R.1 for R1 tens figures: 0, 10, 20, 30, 40, 50, 60, 70, 80, 90 kΩ in ten kΩ steps
- R.2 for R1 units figures: 1, 2, 3, 4, 5, 6, 7, 8, 9, 10 kΩ in one kΩ steps

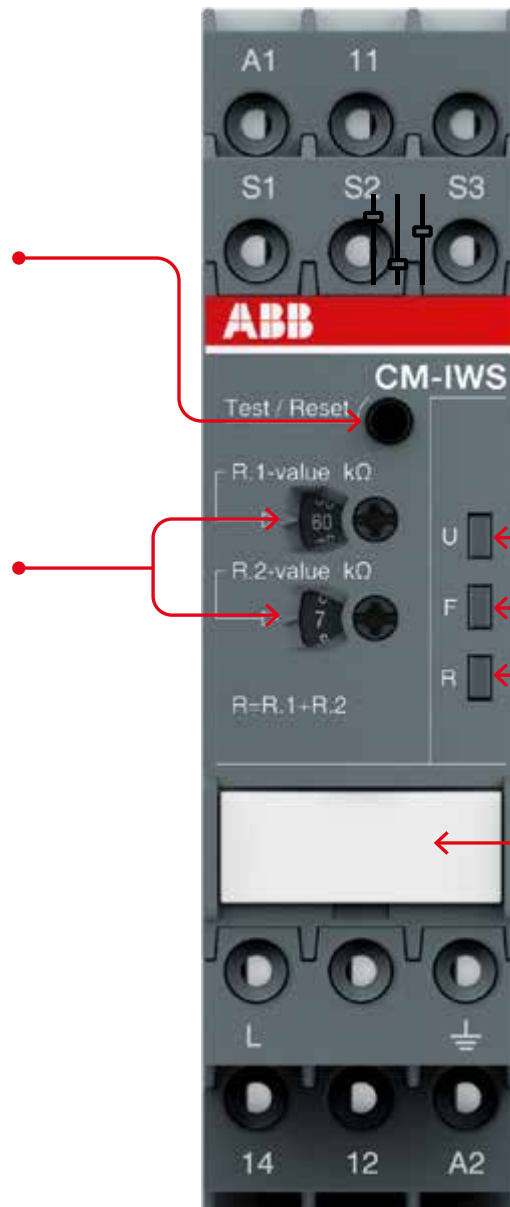

Indication of operational states

- U: green LED - control supply voltage
- F: red LED - fault message
- R: yellow LED - relay status



Marker label for devices without DIP switches

Insulation monitoring relays

Operating controls

CM-IWN



Front-face rotary switches to adjust the threshold value:

- R1.1 for R1 tens figure: 0, 10, 20, 30, 40, 50, 60, 70, 80, 90 kΩ in ten kΩ steps
- R1.2 for R1 units figure: 1, 2, 3, 4, 5, 6, 7, 8, 9, 10 kΩ in one kΩ steps
- R2.1 for R2 tens figure: 0, 20, 40, 60, 80, 100, 120, 140, 160, 180 kΩ in twenty kΩ steps
- R2.2 for R2 units figure: 2, 4, 6, 8, 10, 12, 14, 16, 18, 20 kΩ in two kΩ steps

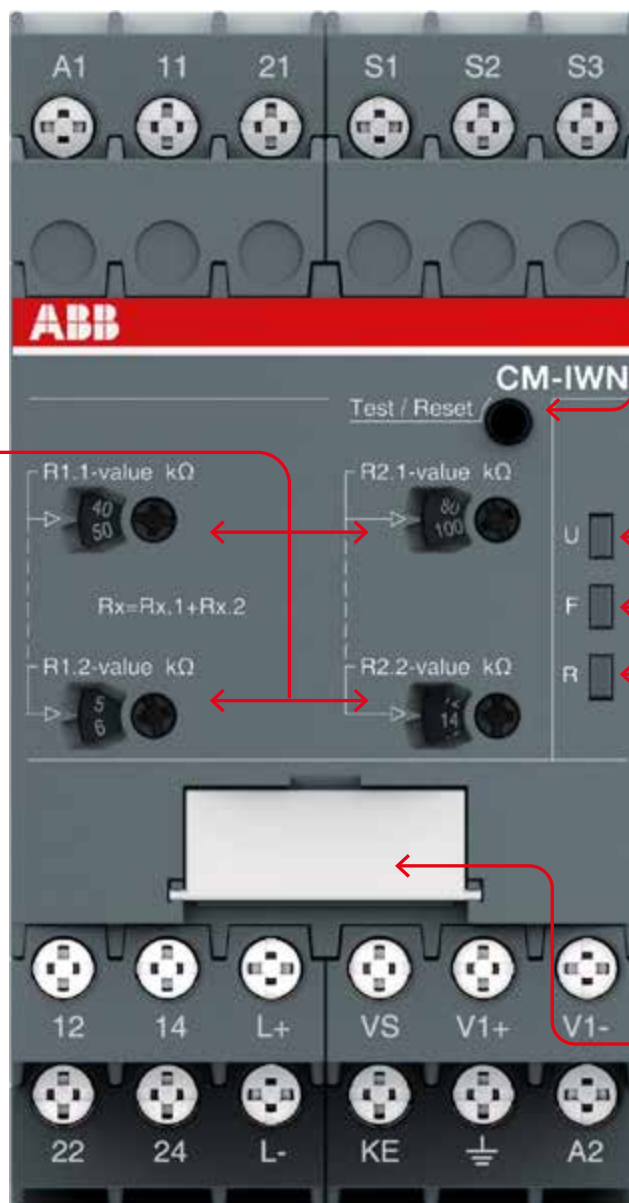

Test and reset button



Indication of operational states

- U: green LED – control supply voltage
- F1: red LED – fault message
- F2: yellow LED – relay status

DIP switches

(see DIP switch functions)

Insulation monitoring relays

Selection table

	Type	Order number							
	CM-IWS.2S	1SVR730670R0200							
	CM-IWS.2P	1SVR740670R0200							
	CM-IWS.1S	1SVR730660R0100							
	CM-IWS.1P	1SVR740660R0100							
	CM-IWN.1S	1SVR750660R0200							
	CM-IWN.1P	1SVR760660R0200							
	CM-IWM.10	1SVR470670R1000							
	CM-IWM.11	1SVR470670R1100							
Rated control supply voltage U_s									
24 - 240 V AC/DC			■	■	■	■	■	■	
24 V DC									■ ■
Measuring voltages									
250 V AC (L-PE)				■	■				
400 V AC (L-PE)		■	■			■	■		
690 V AC (L-PE)						■ (1)	■ (1)	■ (2)	
1000 V AC (L-PE)									■ (3)
300 V DC (L-PE)			■	■					
600 V DC (L-PE)						■	■		
690 V DC (L-PE)								■ (2)	
1000 V DC (L-PE)						■ (1)	■ (1)		■ (3)
Measuring range									
1 - 100 kΩ		■	■	■	■	■	■		
2 - 200 kΩ						■	■		
2 - 250 kΩ								■	■
System leakage capacitance, max.									
10 μF		■	■	■	■				
20 μF						■	■		
1000 μF								■	
3000 μF									■
Output									
1 c/o		■	■	■	■				
1 x 2 c/o or 2 x 1 c/o						■	■		
2 c/o								■	■
Operating principle									
Open-circuit principle		■	■	■	■			■	■
Open- or closed-circuit principle adjustable						■	■		
Test									
Front-face button or control input		■	■	■	■	■	■	■	■
Reset									
Front-face button or control input		■	■	■	■	■	■	■	■
Fault storage / latching configurable		■	■	■	■	■	■		
Non volatile storage configurable		■	■	■	■	■	■		
Interrupted wire detection						■	■	■	■
Threshold values configurable		1	1	1	1	2	2	2	2
Control input (measuring input deactivation)									■
Connection type									
Push-in terminals			■		■		■		
Double-chamber cage connection terminals		■		■		■			
Screw terminals								■	■

1) With coupling unit CM-IVN screw version CM-IVN.S: 1SVR750669R9400
push-in version CM-IVN.P: 1SVR760669R9400

2) Allowed voltage range of the supervised network: 0-760 V AC / 0-1000 V

3) Allowed voltage range of the supervised network: 0-1100 V AC / 0-1500 V DC

Insulation monitoring relays

Ordering details



2CDC251.009.V0012

CM-IWS.1



2CDC251.017.V0012

CM-IWS.2



2CDC251.020.V0012

CM-IWN.1



LK5894

CM-IWM.10



LK5895

CM-IWM.11



2CDC252.027.V0012

CM-IVN

Description

The CM-IWx serves to monitor insulation resistance in accordance with IEC 61557-8 in unearthed IT AC systems, IT AC systems with galvanically connected DC circuits, or IT DC systems. The devices are able to monitor control circuits (single-phase) and main circuits (3-phase).

The CM-IWM.x provides the best and up-to-date insulation monitoring of modern IT supply systems in an optimum and state-of-the-art way according to IEC 61558-8 including annex C. The device can be used in the most flexible way for AC, DC and AC/DC systems, even with a large leakage capacity to earth (PE) and under adverse conditions.

Ordering details

Type	Rated control supply voltage	Nominal voltage U_n of the distribution system to be monitored	System leakage capacitance, max.	Adjustment range of the specified response value R_{an} (threshold)	Type	Order code	Weight (1 pc) kg (lb)
CM-IWS.x	24-240 V AC/DC	0-250 V AC / 0-300 V DC	10 μ F	1-100 k Ω	CM-IWS.1S	1SVR730660R0100	0.148 (0.326)
					CM-IWS.1P	1SVR740660R0100	0.137 (0.302)
		0-400 V AC			CM-IWS.2S	1SVR730670R0200	0.141 (0.311)
					CM-IWS.2P	1SVR740670R0200	0.130 (0.287)
CM-IWN.x		0-400 V AC / 0-600 V DC	20 μ F	1-100 k Ω 2-200 k Ω	CM-IWN.1S	1SVR750660R0200	0.241 (0.531)
					CM-IWN.1P	1SVR760660R0200	0.217 (0.478)
CM-IWM.x	24 V DC	0-690 V AC/DC ¹⁾	1000 μ F	1-250 k Ω 20 k Ω -2 M Ω	CM-IWM.10	1SVR470670R1000	0.500 (1.1)
		0-1000 V AC/DC ²⁾	3000 μ F		CM-IWM.11	1SVR470670R1100	

1) Allowed voltage range of the supervised network: 0-760 V AC / 0-1000 V DC
2) Allowed voltage range of the supervised network: 0-1100 V AC / 0-1500 V DC

Coupling unit

Rated control supply voltage = measuring voltage	Nominal voltage U_n of the distribution system to be monitored	Type	Order code	Weight (1 pc) kg (lb)
Passive device, no control supply voltage needed	0-690 V AC / 0-1000 V DC	CM-IVN.S	1SVR750669R9400	0.179 (0.395)
		CM-IVN.P	1SVR760669R9400	0.165 (0.364)

S: screw connection
P: push-in connection

Insulation monitoring relays

Technical data - CM-IWx

Data at $T_a = 25\text{ °C}$ and rated values, unless otherwise indicated

		CM-IWS.2	CM-IWS.1	CM-IWN.1
Input circuit - Supply circuit		A1 - A2		
Rated control supply voltage U_s		24-240 V AC/DC		
Rated control supply voltage tolerance		-15...+10 %		
Typical current / power consumption		24 V DC	30 mA / 0.7 VA	35 mA / 0.9 VA
		115 V AC	12 mA / 1.4 VA	17 mA / 2.0 VA
		230 V AC	12 mA / 2.8 VA	14 mA / 3.2 VA
Rated frequency f_s		DC or 15-400 Hz		
Frequency range AC		13.5-440 Hz		
Power failure buffering time		min. 20 ms		
Start-up time t_{s1} , fixed		min. 10 s	max. 15 s	min. 15 s
Input circuit - Measuring circuit		L, ±	L+, L-, ±, KE	L+, L-, ±, KE
Monitoring function		insulation resistance monitoring of IT systems		
Measuring principle		superimposed DC voltage	prognostic measuring principle with superimposed square wave signal	
Nominal voltage U_n of the distribution system to be monitored		0-400 V AC	0-250 V AC / 0-300 V DC	0-400 V AC / 0-600 V DC
Voltage range of the distribution system to be monitored		0-460 V AC (tolerance +15 %)	0-287.5 V AC / 0-345 V DC (tolerance +15 %)	0-460 V AC / 0-690 V DC (tolerance +15 %)
Rated frequency f_N of the distribution system to be monitored		50-60 Hz	DC or 15-400 Hz	DC or 15-400 Hz
System leakage capacitance C_e		max. 10 μ F		20 μ F
Tolerance of the rated frequency f_N		45-65 Hz	13.5-440 Hz	13.5-440 Hz
Extraneous DC voltage U_{fg} (when connected to an AC system)		max. none	290 V DC	460 V DC
Number of possible response / threshold values		1		2
Adjustment range of the specified response value R_{an} (threshold)		min.-max. 1-100 Ω	-	
		min.-max. R1	-	
		min.-max. R2	2-200 k Ω (activated / deactivated by DIP-switch)	
Adjustment resolution		1 k Ω	-	
		R1	1 k Ω	
		R2	2 k Ω	
Tolerance of the adjusted threshold value / Relative percentage uncertainty A at -5...+45 °C $U_n = 0-115\%$ $U_s = 85-110\%$ $f_N, f_s, C_e = 1\mu$ F		at 1-10 k Ω R_F (yellow marked scale)	$\geq 15\%$, max. ± 0.5 k Ω	
		at 10-100 k Ω R_F	$\pm 6\%$	
		at 1-15 k Ω R_F	-	
		at 15-200 k Ω R_F	± 1 k Ω , with CM-IVN ± 1.5 k Ω	
			$\pm 8\%$	
Hysteresis related to the threshold value		25 %; min. 2 k Ω		
Internal impedance Z_i		at 50 Hz	135 k Ω	100 k Ω
Internal DC resistance R_i			185 k Ω	115 k Ω
Measuring voltage U_m			15 V	22 V
Tolerance of measuring voltage U_m			+10 %	
Measuring current I_m		max.	0.1 mA	0.3 mA
Response time t_{an}				
		pure AC system $0.5 \times R_{an}$ and $C_e = 1 \mu$ F	max. 10 s	
		DC system or AC system with connected rectifiers	-	max. 15 s
Repeat accuracy (constant parameters)		< 0.1 % of full scale		
Accuracy of R_a (measured value) within the rated control supply voltage tolerance		< 0.05 % of full scale		
Accuracy of R_a (measured value) within the operation temperature range		at 1-10 k Ω R_F	5 Ω / K	
		at 10-100 k Ω R_F	0.05 % / K	
		at 10-200 k Ω R_F	-	
			0.05 % / K	
Transient overvoltage protection (+ - terminal)		Z-diode	avalanche diode	

Insulation monitoring relays

Technical data - CM-IWx

	CM-IWS.2	CM-IWS.1	CM-IWN.1
Input circuit - Control circuits			
Control inputs - volt free	S1-S3	remote test	
	S2-S3	remote reset	
Maximum switching current in the control circuit	1 mA		
Maximum cable length to the control inputs	50 m - 100 pF/m [164 ft - 30.5 pF/ft]		
Minimum control pulse length	150 ms		
No-load voltage at the control input	≤ 24 V ± 5 %	≤ 24 V DC	
Indication of operational states			
Control supply voltage	LED U (green)		
Fault message	LED F (red)		
Relay status	LED R (yellow)		
Output circuits			
Kind of output	relay, 1 c/o (SPDT) contact		2 x 1 or 1 x 2 c/o (SPDT) contacts configurable
Operating principle	closed-circuit principle ¹⁾		open- or closed circuit principle configurable ¹⁾
Contact material	AgNi alloy, Cd free		
Min. switching voltage / Min. switching current	24 V / 10 mA		
Max. switching voltage / Max. switching current	see data sheet		
Rated operational voltage U _e and rated operational current I _e	AC-12 (resistive) at 230 V	4 A	
	AC-15 (inductive) at 230 V	3 A	
	DC-12 (resistive) at 24 V	4 A	
	DC-13 (inductive) at 24 V	2 A	
AC rating (UL 508)	Utilization category (Control Circuit Rating Code)	B 300, pilot duty general purpose 250 V, 4 A, cos φ 0.75	
	max. rated operational voltage	250 V AC	
	max. continuous thermal current at B 300	4 A	
	max. making/breaking apparent power at B 300	3600/360 VA	
Mechanical lifetime	30 x 10 ⁶ switching cycles		
Electrical lifetime (AC-12, 230 V, 4 A)	0.1 x 10 ⁶ switching cycles		
Max. fuse rating to achieve short-circuit protection	n/c contact	6 A fast-acting	
	n/o contact	10 A fast-acting	
Conventional thermal current I _{th}	4 A		
General data			
Duty cycle	100 %		
Dimensions	see dimensional drawings		
Mounting	DIN rail (IEC/EN 60715), snap-on mounting without any tool		
Mounting position	any		
Minimum distance to other units	vertical	not necessary	
	horizontal	10 mm (0.39 in) at U _n > 240 V	not necessary
Material of housing	UL 94 V-0		
Degree of protection	housing / terminal	IP50 / IP20	
Electrical connection			
Wire size	fine-strand with(out) wire end ferrule	Screw connection technology	
		Easy Connect Technology (Push-in)	
		1 x 0.5-2.5 mm ² (1 x 18-14 AWG) 2 x 0.5-1.5 mm ² (2 x 18-16 AWG)	2 x 0.5-1.5 mm ² (2 x 18-16 AWG)
	rigid	1 x 0.5-4 mm ² (1 x 20-12 AWG) 2 x 0.5-2.5 mm ² (2 x 20-14 AWG)	2 x 0.5-1.5 mm ² (2 x 20-16 AWG)
Stripping length	8 mm (0.32 in)		
Tightening torque	0.6-0.8 Nm (5.31-7.08 lb.in)		

¹⁾ Closed-circuit principle: Output relay(s) de-energize(s) if a fault is occurring
Open-circuit principle: Output relay(s) energize(s) if a fault is occurring

Insulation monitoring relays

Technical data - CM-IWx

		CM-IWS.2	CM-IWS.1	CM-IWN.1
Environmental data				
Ambient temperature ranges	operation / storage / transport	-25...+60 °C/-40...+85 °C/-40...+85 °C		
Climatic class	IEC/EN 60721-3-3	3K5 (no condensation, no ice formation)		
Damp heat, cyclic	IEC/EN 60068-2-30	6 x 24 h cycle, 55 °C, 95 % RH		
Vibration, sinusoidal		25 Hz: 2.5 g		
Isolation data				
Rated impulse withstand voltage U_{imp}	supply / measuring circuit	6 kV		
	supply / output circuit	6 kV		
	measuring / output circuit	6 kV		
	output 1 / output circuit 2	4 kV		
Rated insulation voltage U_i	supply / measuring circuit	400 V	300 V	600 V
	supply / output circuit	300 V		
	supply / measuring circuit	400 V	300 V	600 V
	output 1 / output circuit 2	-	-	300 V
Basis insulation	supply / measuring circuit	400 V AC / 300 V DC	250 V AC / 300 V DC	400 V AC / 600 V DC
	supply / output circuit	250 V AC / 300 V DC		
	measuring / output circuit	400 V AC / 300 V DC	250 V AC / 300 V DC	400 V AC / 600 V DC
	output 1 / output 2	250 V AC / 300 V DC		
Protective separation (IEC/EN 61140)	supply / output circuit	250 V AC / 250 V DC		
	supply / measuring circuit	250 V AC / 250 V DC		
	measuring / output circuit	250 V AC / 250 V DC		
Pollution degree		3		
Overvoltage category		III		
Standards / Directives				
Standards		IEC/EN 60947-5-1, IEC/EN 61557-1, IEC/EN 61557-8		
Low Voltage Directive		2014/35/EU		
EMC Directive		2014/30/EU		
RoHS Directive		2011/65/EU		
Electromagnetic compatibility				
Interference immunity to		IEC/EN 61000-6-2, IEC/EN 61326-2-4		
electrostatic discharge	IEC/EN 61000-4-2	level 3, 6 kV / 8 kV		
radiated, radio-frequency, electromagnetic field	IEC/EN 61000-4-3	level 3, 10 V/m (1 GHz) / 3 V/m (2 GHz) / 1 V/m (2.7 GHz)		
electrical fast transient/burst	IEC/EN 61000-4-4	level 3, 2 kV / 5 kHz		
surge	IEC/EN 61000-4-5	level 3, installation class 3, supply circuit and measuring circuit 1 kV L-L, 2 kV L-earth		
conducted disturbances, induced by radio-frequency fields	IEC/EN 61000-4-6	level 3, 10 V		
voltage dips, short interruptions and voltage variations	IEC/EN 61000-4-11	class 3		
harmonics and interharmonics	IEC/EN 61000-4-13	class 3		
Interference emissions		IEC/EN 61000-6-3		
high-frequency radiated	IEC/CISPR 22, EN 55022	class B		
high-frequency conducted	IEC/CISPR 22, EN 55022	class B		

Insulation monitoring relays

Technical data - CM-IVN

		CM-IVN
Input circuit - Measuring circuit		VL+, VL-, V±
Function		expansion of the nominal voltage range of the insulation monitoring relay CM-IWN to 690 V AC or 1000 V DC, max. length of connection cable 40 cm
Measuring principle		see CM-IWN
Nominal voltage U_n of the distribution system to be monitored		0-690 V AC / 0-1000 V DC
Voltage range of the distribution system to be monitored		0-793.5 V AC / 0-1150 V DC (tolerance +15 %)
Rated frequency f_N of the distribution system to be monitored		DC or 15-400 Hz
Tolerance of the rated frequency f_N		13.5-440 Hz
System leakage capacitance C_e	max.	identical to that of the insulation monitoring relay used
Extraneous DC voltage U_{fg} (when connected to an AC system)	max.	793.5 V DC
Tolerance of the adjusted threshold value / Relative percentage uncertainty A at -5...+45 °C, $U_n = 0-115$ %, $U_s = 85-110$ %, $f_N, f_s, C_e = 1 \mu F$	at 1-15 kΩ R_f at 15-200 kΩ R_f	±1.5 kΩ ±8 %
Internal impedance Z_i	at 50 Hz	195 kΩ
Internal DC resistance R_i		200 kΩ
Measuring voltage U_m		24 V
Tolerance of measuring voltage U_m		+10 %
Measuring current I_m		0.15 mA
General data		
MTBF		on request
Duty cycle		100 %
Dimensions		see dimensional drawings
Mounting		DIN rail (IEC/EN 60715), snap-on mounting without any tool
Mounting position		any
Minimum distance to other units	vertical	not necessary
	horizontal	10 mm (0.39 in) at $U_n > 600$ V
Degree of protection		IP50 / IP20
Electrical connection		
Wire size	fine-strand with(out) wire end ferrule	2 x 0.75-2.5 mm ² (2 x 18-14 AWG)
	rigid	2 x 0.5-4 mm ² (2 x 20-12 AWG)
Stripping length		7 mm (0.28 in)
Tightening torque		0.6-0.8 Nm (5.31-7.08 lb.in)
Max. length of connection cable to CM-IWN		40 cm
Environmental data		
Ambient temperature ranges	operation / storage / transport	-25...+60 °C / -40...+85 °C / -40...+85 °C
Climatic category	IEC/EN 60721-3-3	3K5 (no condensation, no ice formation)
Damp heat, cyclic	IEC/EN 60068-2-30	6 x 24 h cycle, 55 °C, 95 % RH
Vibration, sinusoidal	IEC/EN 60255-21-1	Class 2
Shock, half-sine	IEC/EN 60255-21-2	Class 2
Isolation data		
Rated impulse withstand voltage U_{imp}	input circuit / PE	8 kV
Rated insulation voltage U_i	input circuit / PE	1000 V
Pollution degree		3
Overvoltage category		III
Standards / Directives		
Standards		IEC/EN 60947-5-1, IEC/EN 61557-1, IEC/EN 61557-8
Low Voltage Directive		2014/35/EU
EMC Directive		2014/30/EU
RoHS Directive		2011/65/EU

Insulation monitoring relays

Technical data - CM-IVN

		CM-IVN
Electromagnetic compatibility		
Interference immunity to		IEC/EN 61000-6-2, IEC/EN 61326-2-4
electrostatic discharge	IEC/EN 61000-4-2	level 3, 6 kV / 8 kV
radiated, radio-frequency, electromagnetic field	IEC/EN 61000-4-3	level 3, 10 V/m (1 GHz) / 3 V/m (2 GHz) / 1 V/m (2.7 GHz)
electrical fast transient/burst	IEC/EN 61000-4-4	level 3, 2 kV / 5 kHz
surge	IEC/EN 61000-4-5	level 3, installation class 3, supply circuit and measuring circuit 1 kV L-L, 2 kV L-earth
conducted disturbances, induced by radio-frequency fields	IEC/EN 61000-4-6	level 3, 10 V
voltage dips, short interruptions and voltage variations	IEC/EN 61000-4-11	level 3
harmonics and interharmonics	IEC/EN 61000-4-13	level 3
Interference emission		IEC/EN 61000-6-3
high-frequency radiated	IEC/CISPR 22, EN 50022	class B
high-frequency conducted	IEC/CISPR 22, EN 50022	class B

Insulation monitoring relays

Technical data - CM-IWM

	CM-IWM.10	CM-IWM.11
Input circuit		
Rated control supply voltage U_s	24 V DC	
Voltage range	20-30 V DC	
Typical power consumption	max. 5 W	
Measuring circuit		
	L(+) / L(-) to PE / KE	
Nominal voltage U_N	0-690 V AC/DC	0-1000 V AC/DC
Allowed voltage range of the supervised network	0-760 V AC / 0-1000 V DC	0-1100 V AC / 0-1500 V DC
Frequency range	DC or 16-1000 Hz	DC or 16-1000 Hz
Max. system leakage capacitance C_e	1000 μ F	3000 μ F
Internal resistance (AC/DC)	> 280 k Ω	
Measuring voltage	approx. \pm 95 V	
Max. measured current ($R_e = 0$)	< 0.35 mA	
Response values R_e each adjustable via rotary switches	pre-warning ("VW")	warning ("AL")
	20 k Ω	1 k Ω
	30 k Ω	3 k Ω
	50 k Ω	10 k Ω
	70 k Ω	20 k Ω
	100 k Ω	30 k Ω
	150 k Ω	50 k Ω
	250 k Ω	70 k Ω
	500 k Ω	100 k Ω
	1000 k Ω	150 k Ω
	2000 k Ω	250 k Ω
Response inaccuracy	IEC/EN 61557-8	\pm 15 % + 1.5 k Ω
Response value hysteresis	at range 10 k Ω ... 700 k Ω	approx. 25 %
	out of range:	approx. 40 % + 0.5 k Ω
ON delay	at $C_e = 1 \mu$ F	< 10 s
	R_e of ∞ to 0.5 * response value	
Control input		
	between T, R and G	between HM, T, R and G
Current flow	approx. 3 mA	
No-load voltage to ground	approx. 12 V	
Permissible wire length	< 50 m	
Min. activation time	0.5 s	
Output		
Contacts	2 x 1 c/o contacts for VW and AL	
Thermal current I_{th}	4 A	
Switching capacity to AC-15	n/o contact	3 A / AC 230 V acc. to IEC/EN 60947-5-1
	n/c contact	1 A / AC 230 V acc. to IEC/EN 60947-5-1
Electrical life	at 8 A, AC 250 V	1 x 10 ⁴ switching cycles
Short circuit strength max. fuse rating	4 A gL acc. to IEC/EN 60947-5-1	
Mechanical life	10 x 10 ⁶ switching cycles	

Insulation monitoring relays

Technical data - CM-IWM

	CM-IWM.10	CM-IWM.11
General Data		
Operating mode	continuous operation	
Temperature range	operation	- 25 ... + 60 °C
	storage	- 40 ... + 70 °C
Relative air humidity	93 % at 40 °C	
Atmospheric pressure	860-1600 mbar (86-106 kPa)	
Altitude	IEC/EN 60664-1	< 4000 m
Clearance and creepage distances		
Rated impulse voltage / pollution degree	IEC/EN 60664-1	
Measuring circuit L(+) / L(-) to	auxiliary voltage DC and relay contacts VW, AL	8 kV / 2
	auxiliary voltage DC to relay contacts VW, AL	8 kV / 2
	relay contacts VW to relay contact AL	4 kV / 2
Insulation test voltage, routine test	AC 5 kV; 1 s AC 2.5 kV; 1 s	
Technical data		
EMC		
Electrostatic discharge (ESD)	IEC/EN 61000-4-2	8 kV (air)
HF irradiation	IEC/EN 61000-4-3	80 MHz-2.7 GHz: 10 V/m
Fast transients	IEC/EN 61000-4-4	4 kV
Surge voltages	IEC/EN 61000-4-5	between A1 - A2: 1 kV L(+) - L(-): 2 kV A1, A2 - PE: 4 kV L(+), L(-) - PE: 4 kV control line: 0.5 kV control line and earth: 1 kV
HF-wire guided	IEC/EN 61000-4-6	10 V
Interference suppression	EN 55011	limit value class A when connected to a low voltage public system (Class B, EN 55011) radio interference can be generated. To avoid this, appropriate measures have to be taken
Degree of protection		
Housing	IEC/EN 60529	IP 40
Terminals	IEC/EN 60529	IP 20
Housing		thermoplastic with V0 behaviour according to UL subject 94
Vibration resistance	IEC/EN 60068-2-6	10-55 Hz: 0.35 mm 2-13.2 Hz: ± 1 mm 13.2-100 Hz: ± 7 g
Shock resistance	IEC/EN 60068-2-27	10 g / 11 ms, 3 pulses
Climate resistance	IEC/EN 60068-1	25 / 060 / 04
Terminal designation		EN 50005
Connecting capacity		1 x 4 mm ² solid
		1 x 2.5 mm ² stranded ferruled (isolated)
		2 x 1.5 mm ² stranded ferruled (isolated) DIN 46228-1/-2/-3-4
		2 x 2.5 mm ² stranded ferruled (isolated) DIN 46228-1/-2/-3
Stripping length		8 mm
Tightening torque		0.8 Nm
Wire fixing		plus-minus terminal screws M3.5 terminal with wire protection
Mounting	IEC/EN 60715	DIN rail
Dimensions	width x height x depth	90 x 90 x 121 mm

Insulation monitoring relays

Technical diagrams

LEDs, status information and fault messages

CM-IWN.x

Operational state	LED U (green)	LED F (red)	LED R (yellow)
Start-up		OFF	OFF
No fault		OFF	(1)
Prewarning			
Insulation fault (below threshold value)			(1)
KE/± wire interruption			(1)
L+/L- wire interruption during system start-up / test function	 		(1)
System leakage capacitance too high / invalid measurement result			(1)
Internal system fault	(1)		(1)
Setting fault (2)			
Test function		OFF	(1)
No fault after fault storage (3)		(4)	

CM-IWS.x

Operational state	LED U (green)	LED F (red)	LED R (yellow)
Start-up		OFF	OFF
No fault		OFF	
Insulation fault (below threshold value)			OFF
Invalid measuring result			OFF
KE/± wire interruption (only CM-IWS. (1)			OFF
CM-IWS.1: System leakage capacitance too high / invalid measurement result			OFF
CM-IWS.2: Invalid measurement result			OFF
Internal system fault	OFF		OFF
Test function		OFF	OFF
No fault after fault storage (3)		(4)	

(1) Depending on the configuration.

(2) Possible faulty setting: The threshold value for final switch-off is set at a higher value than the threshold value for prewarning

(3) The device has triggered after an insulation fault. The fault has been stored and the insulation resistance has returned to a higher value than the threshold value plus hysteresis.

(4) Depending on the fault

CM-IWM.x

LED status	LED	Status
PWR: green LED		Control supply voltage applied
ERR: red LED		Internal device error
		Connection error L+/L-
Active: green LED		Connection error PE/KE
		Measuring phase with positive polarity
LED chain: yellow LED		Measuring phase with negative polarity
		8 LEDs indicate the current insulating resistance ($\leq 10 \text{ k}\Omega \dots \geq 2 \text{ M}\Omega$)
VW +: yellow LED		R_e lower than prewarning value to + potential
VW -: yellow LED		R_e lower than prewarning value to - potential
VW + and VW -: yellow LED		AC fault / symmetric fault
AL +: red LED		R_e lower than warning value to + potential
AL -: red LED		R_e lower than warning value to - potential
AL + and AL -: red LED		AC fault / symmetric fault

Insulation monitoring relays

Technical diagrams

Connection diagrams

CM-IWS.2

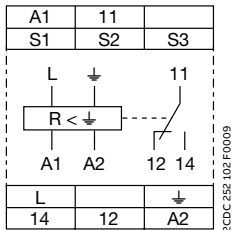

A1-A2	Control supply voltage
S1-S3	Remote test
S2-S3	Remote reset
L	Measuring circuit/input, system connection
↓	Measuring circuit/input, earth connections
11-12/14	Output relay, closed-circuit principle

CM-IWS.1

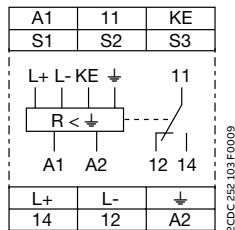

A1-A2	Control supply voltage
S1-S3	Remote test
S2-S3	Remote reset
L+, L-	Measuring circuit/input, system connection
↓, KE	Measuring circuit/input, earth connections
1-12/14	Output relay, closed-circuit principle

CM-IWN.1

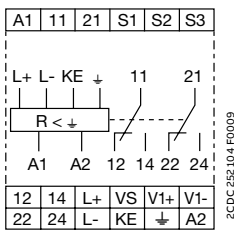

A1-A2	Control supply voltage
S1-S3	Remote test
S2-S3	Remote reset
L+, L-	Measuring circuit/input, system connection
↓, KE	Measuring circuit/input, earth connections
VS, V1+, V1	Connections for the coupling unit (if used)
11-12/14	Output relay 1, open- or closed-circuit principle
21-22/24	Output relay 2, open- or closed-circuit principle

CM-IVN

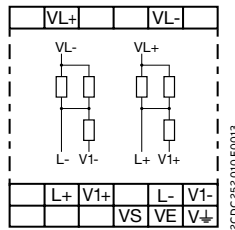

VE	Connection to CM-IWN.x - ↓
VS	Connection to CM-IWN.x - VS
L+	Connection to CM-IWN.x - L+
V1+	Connection to CM-IWN.x - V1+
L-	Connection to CM-IWN.x - L-
V1-	Connection to CM-IWN.x - V1-
VL+	Measuring circuit / Measuring input, Connection to the system
VL-	Measuring circuit / Measuring input, Connection to the system
V↓	Measuring circuit / Measuring input, Connection to earth

Insulation monitoring relays

Technical diagrams

Connection diagrams

CM-IWM.10

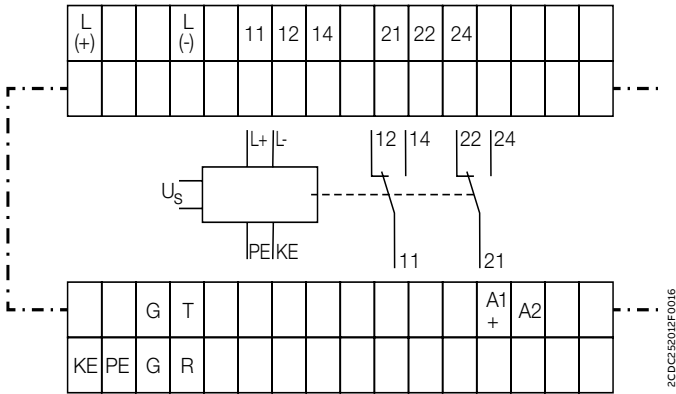

Terminal designation	Signal designation
A1+, A2	Control supply voltage
L(+), L(-)	Connection for measuring circuit
KE, PE	Connection for protective conductor
G, R	Control input (manual/auto reset) <ul style="list-style-type: none"> G/R not jumpered: manual reset G/R jumpered: auto reset
G, T	Control input (External test input) connection for an external device test pushbutton
11-12/14	Output relay 1 (warning)
21-22/24	Output relay 2 (prewarning)

CM-IWM.11

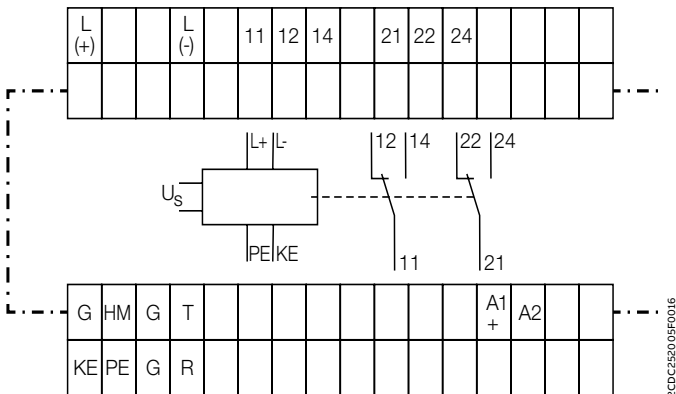

Terminal designation	Signal designation
A1+, A2	Control supply voltage
L(+), L(-)	Connection for measuring circuit
KE, PE	Connection for protective conductor
G, R	Control input (manual/auto reset) <ul style="list-style-type: none"> G/R not jumpered: manual reset G/R jumpered: auto reset
G, T	Control input (External test input) connection for an external device test pushbutton
G, HM	Control input (measuring circuit deactivation) <ul style="list-style-type: none"> G/HM not jumpered: measuring circuit activated G/HM jumpered: measuring circuit deactivated
11-12/14	Output relay 1 (warning)
21-22/24	Output relay 2 (prewarning)

Insulation monitoring relays

Technical diagrams

DIP switches

CM-IWN.1

Position	4	3	2	1
ON ↑				
OFF				

2CDC 252 050 F0009

	ON	OFF (default)
DIP switch 1 Operating principle of the output relays	Closed-circuit principle If closed-circuit principle is selected, the output relays de-energize in case a fault is occurring. In non-fault state the relays are energized.	Open-circuit principle If open-circuit principle is selected, the output relays energize in case a fault is occurring. In non-fault state the relays are de-energized.
DIP switch 2 Non-volatile fault storage	Fault storage activated (latching) If the fault storage function is activated, the output relays remain in tripped position until a reset is done either by the front-face button or by the remote reset connection S2-S3. This function is non-volatile.	Fault storage de-activated (non latching) If the fault storage function is de-activated, the output relays switch back to their original position as soon as the insulation fault no longer exists.
DIP switch 3 Interrupted wire detection	Interrupted wire detection activated With this configuration, the CM-IWN.1 monitoring relays the wires connected to \pm and KE for interruptions.	Interrupted wire detection de-activated With this configuration the interrupted wire detection is de-activated.
DIP switch 4 2 x 1 c/o, 1 x 2 c/o	2 x 1 c/o (SPDT) contact If operating principle 2 x 1 c/o contact is selected, the output relay R1 (11-12/14) reacts to threshold value R1 (final switch-off) and the output relay R2 (21-22/24) reacts to threshold value R2 (prewarning)	1 x 2 c/o (SPDT) contacts If operating principle 1 x 2 c/o contacts is selected, both output relays R1 (11-12/14) and R2 (21-22/24) react synchronously to threshold value R1. Settings of the threshold value R2 have no effect on the operation.

Insulation monitoring relays

Technical diagrams

Wiring diagrams

CM-IWS.1

Always connect L+ and L- to different conductors. L+ and L- can be connected to any of the conductors.
 $U_n \leq 250 \text{ V AC}; 300 \text{ V DC}$

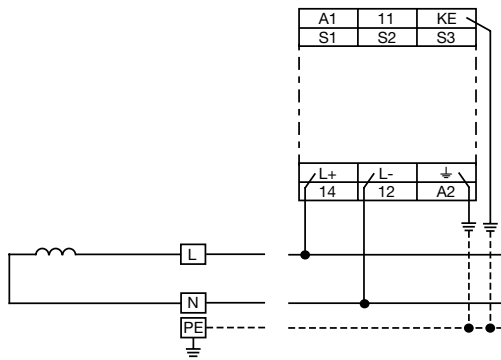

2CDC252.085.F0009, 2CDC252.085.F0009

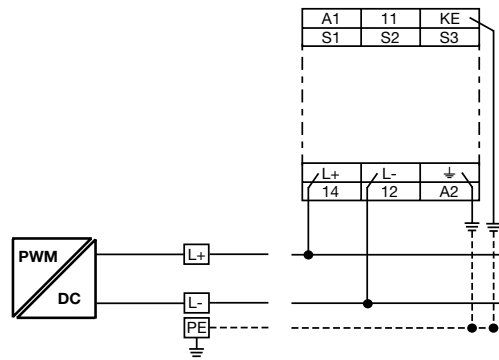

2CDC252.085.F0009, 2CDC252.085.F0009

2-wire AC system

2-wire DC system

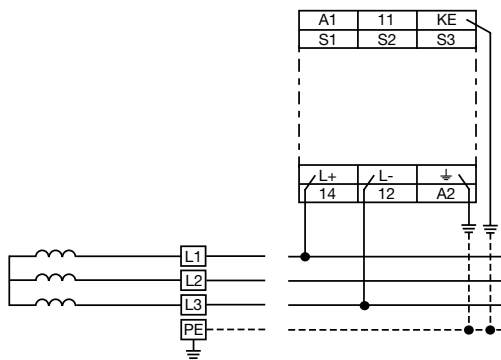

2CDC252.082.F0009, 2CDC252.082.F0009

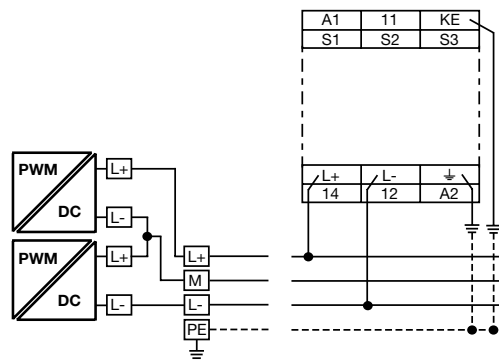

2CDC252.082.F0009, 2CDC252.082.F0009

3-wire AC system

3-wire DC system

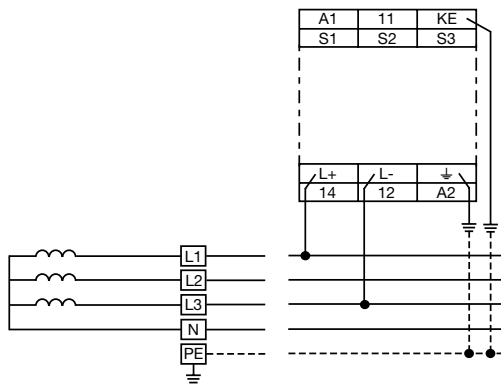

2CDC252.099.F0009, 2CDC252.099.F0009

4-wire AC system

Insulation monitoring relays

Technical diagrams

Wiring diagrams

CM-IWS.2

L can be connected to any of the conductors.
 $U_n \leq 400 \text{ V AC}$

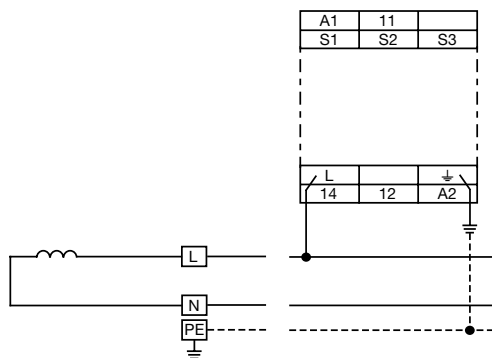

2CDC252083F0009, 2CDC252085F0009

2-wire AC system

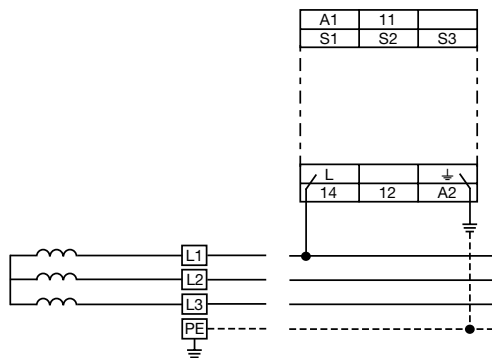

2CDC252090F0009, 2CDC252088F0009

3-wire AC system

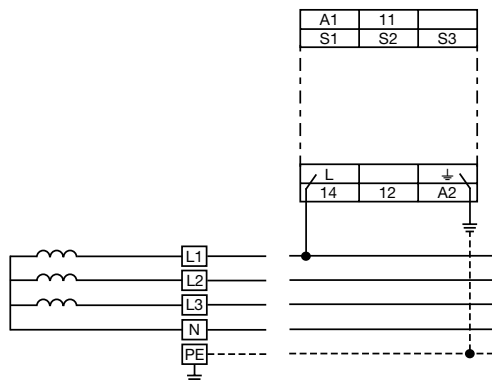

2CDC252097F0009, 2CDC252096F0009

4-wire AC system

Insulation monitoring relays

Technical diagrams

Wiring diagrams

CM-IWN.1

Always connect L+ and L- to different conductors. L+ and L- can be connected to any of the conductors.
 $U_n \leq 400$ V AC; 600 V DC (For monitoring of systems with higher voltages, use coupling unit CM-IVN.)

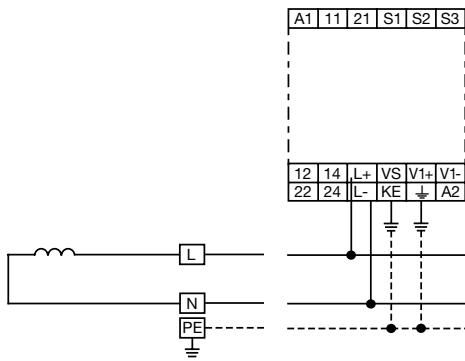

2CDC252086F0009, 2CDC252088F0009

2-wire AC system

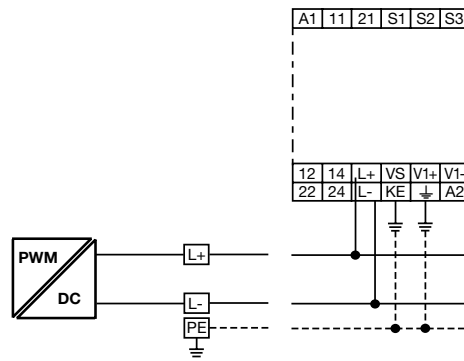

2CDC252086F0009, 2CDC252088F0009

2-wire DC system

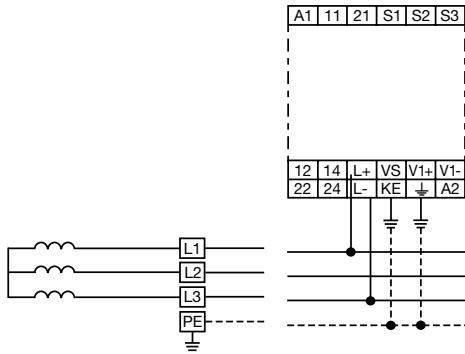

2CDC252093F0009, 2CDC252099F0009

3-wire AC system

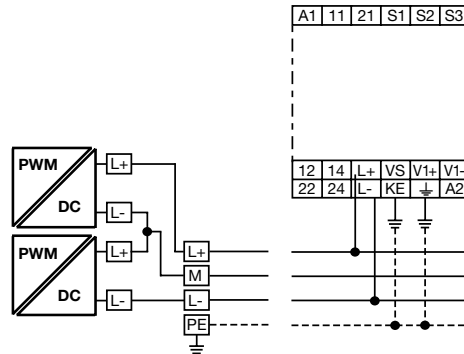

2CDC252093F0009, 2CDC252099F0009

3-wire DC system

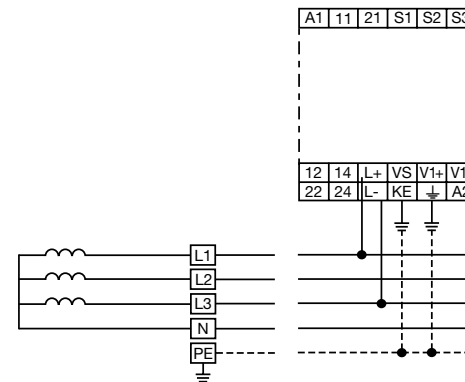

2CDC252100F0009, 2CDC252098F0009

4-wire AC system

Insulation monitoring relays

Technical diagrams

Wiring diagrams

CM-IWM.10

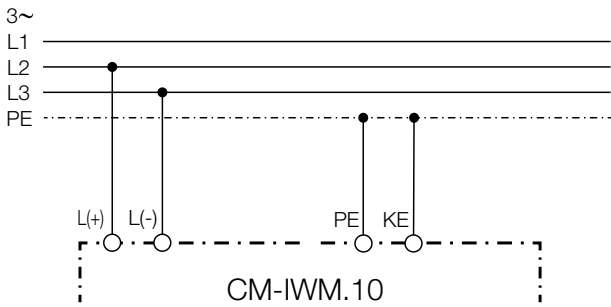

Example of a AC application

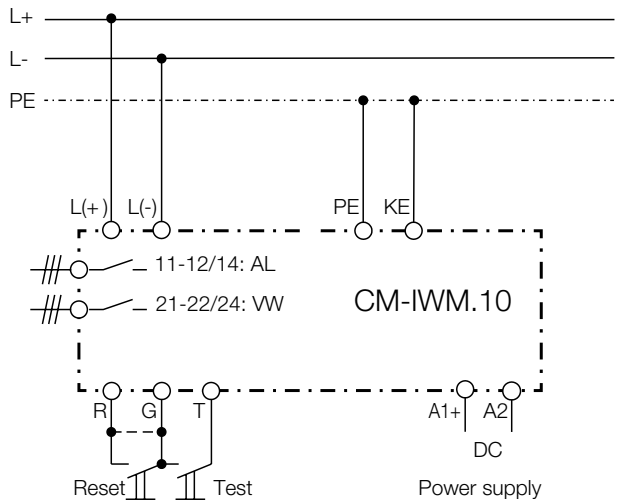

Example of a DC application

CM-IWM.11

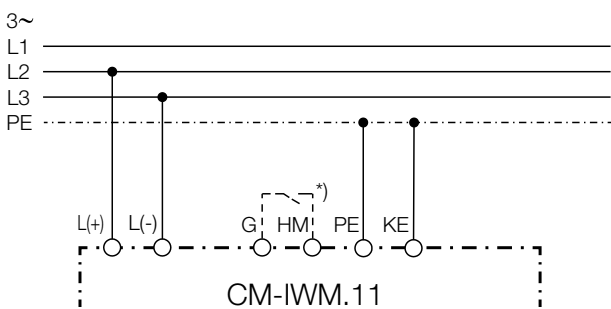

*) G-HM connected: Measuring circuit is off

Example of a AC application

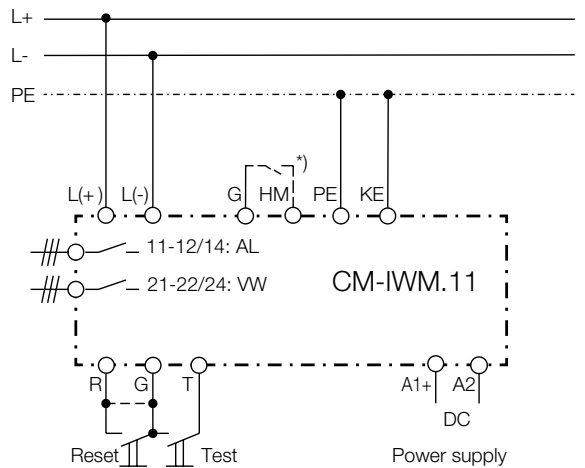

*) G-HM connected: Measuring circuit is off

Example of a DC application

2CDC252011F0016

2CDC252006F0016

2CDC252007F0016

2CDC252006F0016

Insulation monitoring relays

Technical diagrams

Dimensional drawings

in mm and inches

CM-IWS.x

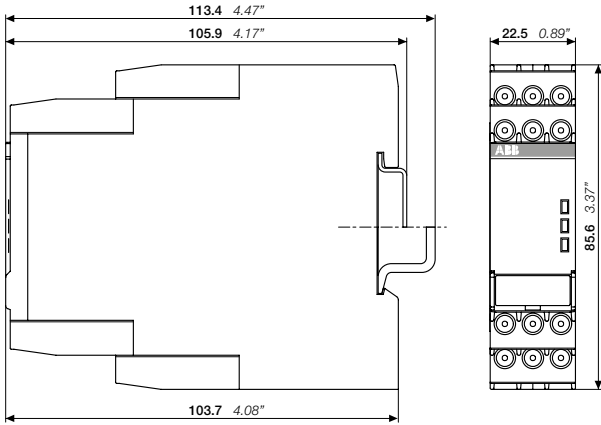

2CDC252009F0011

CM-IWS.x

Accessories

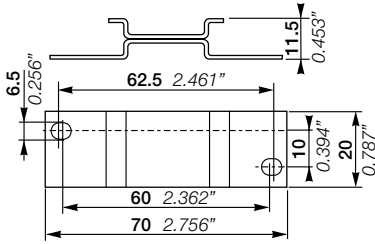

2CDC252008F0010

ADP.01 - Adapter for screw mounting

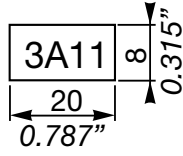

2CDC252186F0005

MAR.01 - Marker label for devices without DIP

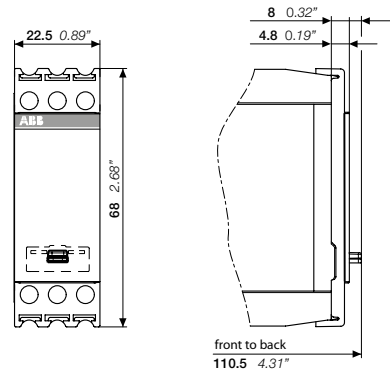

2CDC252010F0011

COV.11 - Sealable transparent cover switches

Insulation monitoring relays

Technical diagrams

Dimensional drawings

in mm and inches

CM-IWN.x

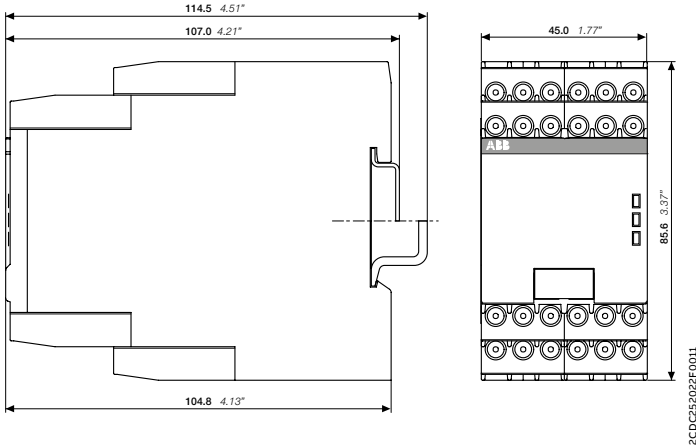

CM-IWN.x

Accessories

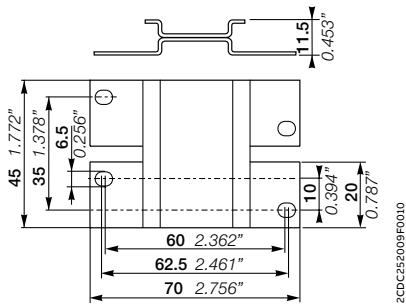

ADP.02 - Adapter for screw mounting

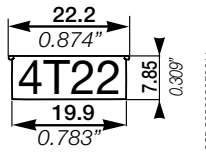

MAR.12 - Marker label for devices with DIP switches

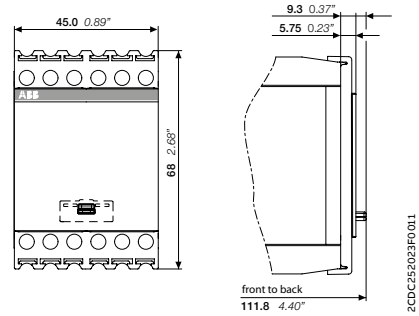

COV.12 - Sealable transparent cover



Thermistor motor protection relays

Table of contents

182	Benefits and advantages
183	Applications
184	Features
186	Offer overview
188	Operating controls
189	Selection table
190	Ordering details
192	Technical data
199	Technical diagrams

Thermistor motor protection relays

Benefits and advantages



The thermistor motor protection relays of the CM-MSx range protect motors with PTC sensors against high temperature. These sensors are incorporated in the motor windings, thus measuring the motor heat directly.

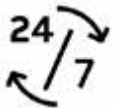

Continuous operation

By using thermistor motor protection relays from ABB, the down and commissioning time can be reduced. The relay is continuously monitoring the sensor circuit to detect short-circuit or interrupted i.e. wire faults, thus contributing to maintenance and time saving in case of faults. In addition, the clear error messages of the front LEDs makes it possible to distinguish between the various fault causes.



Reliable in harsh conditions

Direct motor protection through temperature monitoring of the motor winding offers 100 % motor protection, even under the most difficult ambient conditions. The ABB thermistor motor protection relays give you access to worldwide markets and are approved by local and international standards for many applications such as industry, renewable energies, the marine sector and dangerous and explosive environments. To prove that, the CM-MSS thermistor motor protection relays are certified according to ATEX Ex II (2) G and D for environments with explosive gas or dust loads.



Easy installation

Due to the compliance with the latest standards, there is no need to make any adjustments on the device. All relays come with two different connection possibilities - screw or push-in - to make any adjustments on the installation a breeze. Thanks to direct measurement of the motor temperature, dimensioning of the thermistor motor protection relay, considering the size of the motor, is not necessary.

Thermistor motor protection relays

Applications



Direct temperature monitoring

Generally, motor damage caused by overload or overheating situations can be prevented in different ways. Compared to the indirect temperature measuring which monitors the motor current, the temperature inside the motor can be measured by direct temperature measuring. This enables direct control and evaluation of different operating conditions:

Therefore, the consequences from overheating, such as abrasion as well as electrical failures, can be prevented. The direct measuring principle is carried out by a combination of the thermistor motor protection relay and three PTC sensors which are installed directly in the motor by the manufacturer. Those 3 PTC sensors are placed directly at the thermal hotspots, the motor windings.

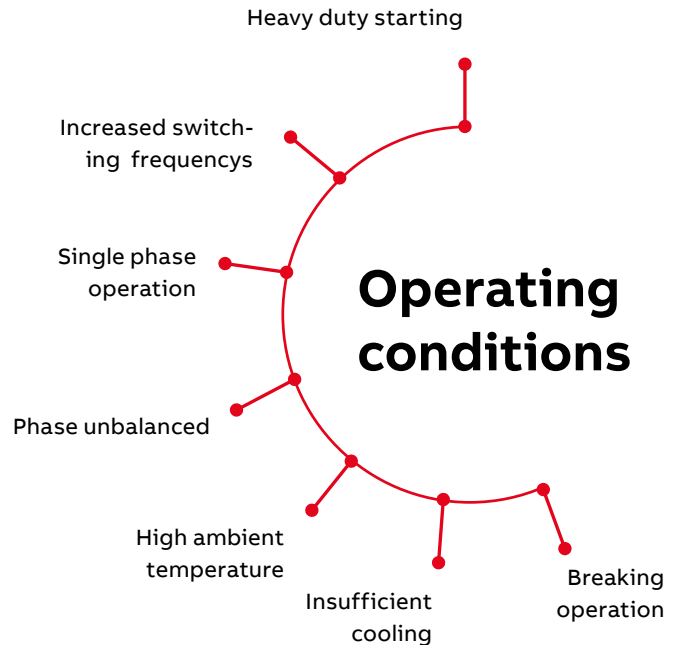

Motor protection using current- and temperature-dependent protective devices

IEC 60204 stipulates that motors must be protected from overheating at a rating of 0.5 kW and higher. The protection can be provided or executed by overload protection, overtemperature protection or current limiting. For motors with frequent starting and braking, and in environments where cooling may be impaired (e.g. by dust), it is recommended to use the overtemperature protection option in the form of a protective device coordinated with this mode of operation.

On rotor-critical motors, overtemperature detection in the stator windings can lead to delayed and hence inadequate protection. In this case, the standards stipulate additional protection, e.g. by means of an overload relay. This combination of thermistor motor protection and an overload relay is recommended for full motor protection in case of frequent starting and braking of motors, irregular intermittent duty or excessive switching frequency.



Operating mode

The thermistor motor protection relays are used to monitor the temperature of motors or generators equipped with PTC sensors type A according to the latest product standard IEC/EN 60947-8. The sensors are built-in into the motor windings, measuring the motor heating. In case of an increase of the temperature in the motor, the resistance of the PTC sensors increases as well. If the motor heats-up excessively ($>2.83 \text{ k}\Omega$), the output relay(s) de-energize(s) and the corresponding LED displays the overtemperature. A short circuit and an interrupted wire within the sensor circuit can also be detected. A reset is only possible after cooling down of the motor ($<1.1 \text{ k}\Omega$) or after a wire interruption, or a short circuit within the sensor circuit has been removed. A reset after tripping can be done manually with the Test / Reset button, externally with a push button between S1 and 1T2/2T2, or automatically by jumpering S1-1T2/2T2.

Thermistor motor protection relays

Features



Test function

The test function is only possible when there is no fault. By pressing the front-face combined Test / Reset button, a system test routine is executed. If the function „Remote Test / Reset“ (DIP switch 4) is activated, the system test routine is also possible via control input S1-T2 (S1-1T2/2T2*).

After starting the test routine, the output relays de-energize. They remain de-energized until the Test / Reset button is pressed again or control input S1-T2 (S1-1T2/2T2*) is closed (remote reset).

Short-circuit detection

If a short circuit is detected between the two lines of a sensor circuit, the output relay(s) de-energize(s) and the LEDs will display the specific error code.

Dynamic interrupted wire detection



During the operation, the device is permanently monitoring the measuring circuit. If the resistance in the measuring circuit rises, the device distinguishes if there is an overtemperature or an interrupted wire.



Fault storage , reset function

The fault storage is designed as non-volatile (remanent). This means that after switch-off and return of the control supply voltage the device returns to the state it was prior to the switch-off. If there was no fault prior to the interruption of the control supply voltage, the device restarts automatically after re-applying control supply voltage.

If there was a fault prior to the interruption, reset can be reset manually by the Test / Reset button or externally by remote reset between S1-T2 (S1-1T2/2T2*). With deactivated fault storage, reset can be made manually by the Test / Reset button, automatically by jumpering S1-T2 (S1-1T2/2T2*) or externally by remote reset between S1-T2 (S1-1T2/2T2*). Depending on the configuration of DIP switch 1, there are several possibilities to reset the device as shown in the picture.

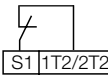
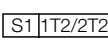
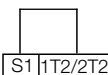
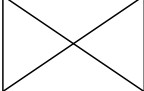
DIP switch 1		
 S1 1T2/2T2	1.) Front 2.) Remote 3.) A1-A2	1.) Front 2.) Remote
 S1 1T2/2T2	1.) Front 2.) A1-A2	1.) Front
 S1 1T2/2T2	1.) Auto-Reset	

*CM-MSS.51

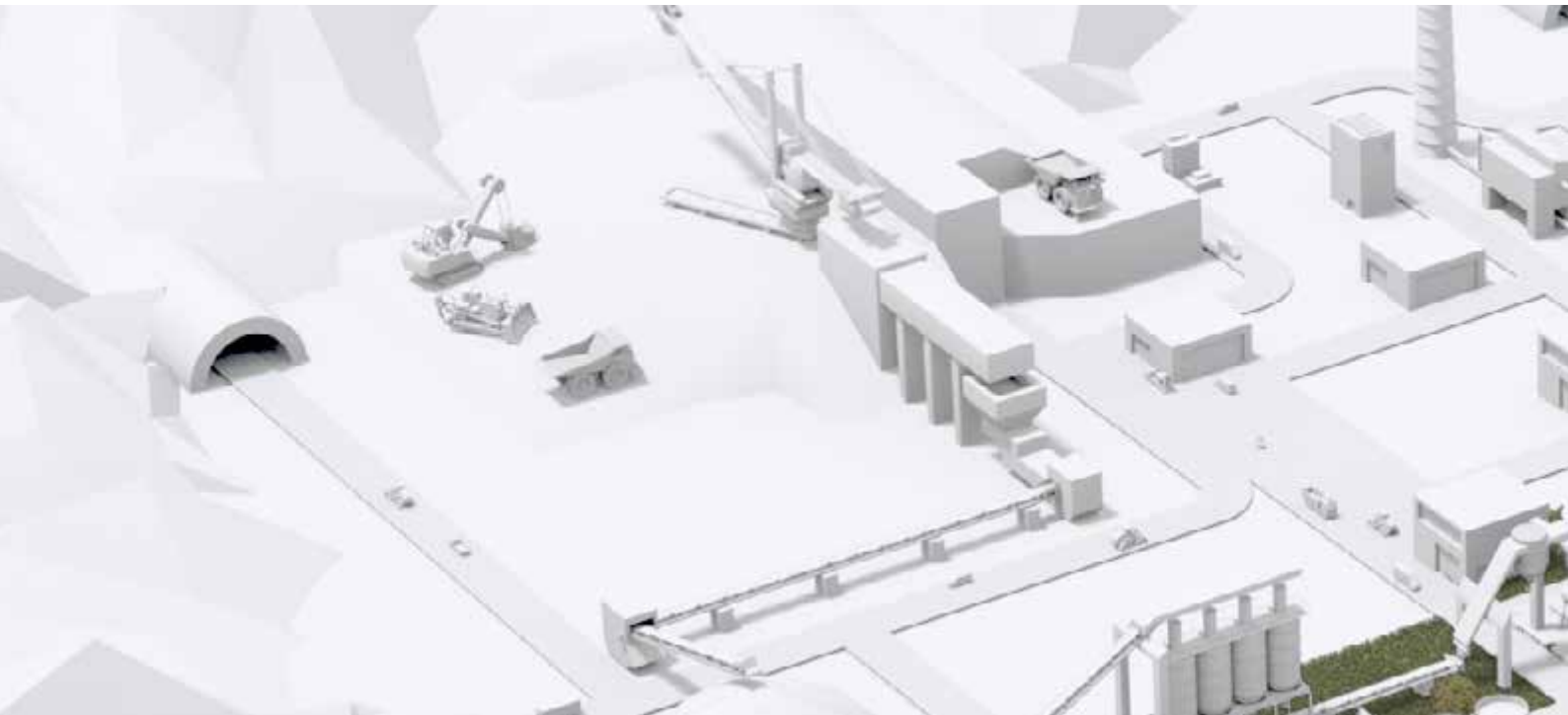

Thermistor motor protection relays

Features



Single and accumulative evaluation

Single evaluation 2x1 c/o

If a fault occurs in the measuring circuit 1, output relay 1 (11-12/14) de-energizes. If a fault occurs in the measuring circuit 2, output relay 2 (21-22/24) de-energizes.

Accumulative evaluation 1x2 c/o

In case of a fault in one of the two measuring circuits, both output relays de-energize synchronously.

Bimetallic switches

In some applications, bimetallic switches - such as Klixon - are used as sensors instead of PTC temperature sensors. Bimetallic switches are temperature and current dependent, normally closed contacts, and are available for different temperature ranges. Since bimetallic switches have almost no resistance below their opening temperature, short-circuit detection is not possible when bimetallic switches are used.



ATEX certification

Suitably selected and adjusted devices are necessary for the safe operation of explosion-protected motors. Only the sensor line is conducted into the explosive atmosphere. The motor protection relay itself must be installed outside the potentially explosive atmospheres.

Marking:



II (2) G

II (2) D



CM-MSS functionality video



Thermistor motor protection relays

Offer overview



CM-MSE

- Auto reset
- Connection of several sensors (max. 6 sensors connected in series)
- Monitoring of bimetals
- 1 n/o contact
- Excellent cost / performance ratio



CM-MSS⁽¹⁾

- Different types of contacts available
 - 1 x 2 c/o (SPDT) contacts
 - 2 x 1 c/o (SPDT) contact
 - 1 n/o and 1 n/c contact
- 1 or 2 measuring circuits
- Different types of reset functions
 - Automatic
 - Manual
 - Remote
- Rated control supply voltages
 - 24 V AC/DC
 - 24-240 V AC/DC
 - 110-130 V AC, 220-240 V AC
- Various approvals and marks

⁽¹⁾ Depending on device the characteristics vary, for detailed overview see "Selection table" on page 189.



Thermistor motor protection relays

Operating controls



Test / Reset button

Test - only possible if/when the relay doesn't show any fault.
 Reset - only possible if measured value < switch-on resistance



Marker label / DIP switches (depending on device) e.g.

- Single evaluation 2 x 1 c/o (SPDT) contact
- Accumulative evaluation 1 x 2 c/o (SPDT) contacts
- Short-circuit detection de-activated
- Short-circuit detection activated
- Non-volatile fault storage activated
- Non-volatile fault storage de-activated
- Remote Reset
- Remote Test/Reset

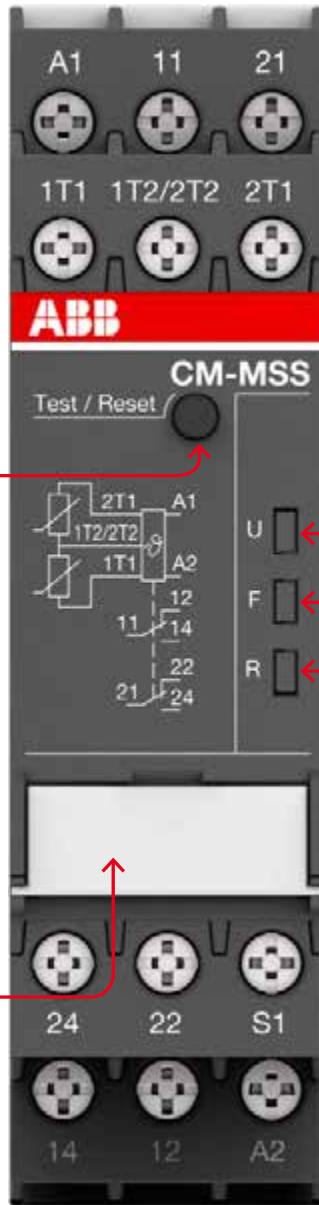

Indication of operational states with LEDs

U: green LED - Status indication of control supply voltage
 Control supply voltage applied
 F: red LED - Fault message
 R: yellow LED - Status indication of the output relay

For detailed status and failure analysis, please see "LEDs, status information and fault messages".

Thermistor motor protection relays

Ordering details



CM-MSS.12S

2CDC 251 004 V0014



CM-MSS.41S

2CDC 251 013 V0014



CM-MSS.51S

2CDC 251 014 V0014

Description

The thermistor motor protection relay CM-MSS monitors the winding temperature and thus protects the motor from overheating, overload and insufficient cooling in accordance to the product standard IEC/EN 60947-8.

Ordering details

CM-MSx

Characteristics	Type	Order code	Weight (1 pc) kg (lb)
See selection table	CM-MSE	1SVR550805R9300	0.11 (0.24)
	CM-MSE	1SVR550800R9300	0.11 (0.24)
	CM-MSE	1SVR550801R9300	0.11 (0.24)
	CM-MSS.11P	1SVR740720R1400	0.119 (0.263)
	CM-MSS.11S	1SVR730720R1400	0.127 (0.280)
	CM-MSS.12P	1SVR740700R0100	0.105 (0.231)
	CM-MSS.12S	1SVR730700R0100	0.113 (0.249)
	CM-MSS.13P	1SVR740700R2100	0.147 (0.324)
	CM-MSS.13S	1SVR730700R2100	0.155 (0.342)
	CM-MSS.21P	1SVR740722R1400	0.118 (0.260)
	CM-MSS.21S	1SVR730722R1400	0.126 (0.278)
	CM-MSS.22P	1SVR740700R0200	0.121 (0.267)
	CM-MSS.22S	1SVR730700R0200	0.132 (0.291)
	CM-MSS.23P	1SVR740700R2200	0.163 (0.359)
	CM-MSS.23S	1SVR730700R2200	0.174 (0.384)
	CM-MSS.31P	1SVR740712R1400	0.120 (0.265)
	CM-MSS.31S	1SVR730712R1400	0.128 (0.282)
	CM-MSS.32P	1SVR740712R0200	0.120 (0.265)
	CM-MSS.32S	1SVR730712R0200	0.130 (0.287)
	CM-MSS.33P	1SVR740712R2200	0.162 (0.357)
	CM-MSS.33S	1SVR730712R2200	0.172 (0.379)
	CM-MSS.41P	1SVR740712R1200	0.130 (0.287)
	CM-MSS.41S	1SVR730712R1200	0.141 (0.311)
	CM-MSS.51P	1SVR740712R1300	0.135 (0.298)
CM-MSS.51S	1SVR730712R1300	0.145 (0.320)	

S: screw connection
P: push-in connection

Thermistor motor protection relays

Ordering details - PTC temperature sensors C011



Temperature sensor example

ISVC 110 000 F0531

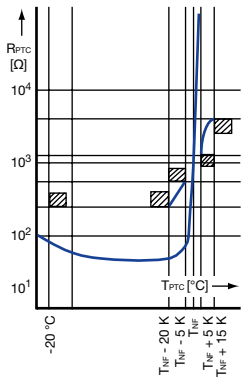

Temperature sensor characteristics

2CDC 252 068 F0208

Description

The PTC temperature sensors (temperature-dependent with positive temperature coefficient) are selected by the manufacturer of the motor depending on:

- the motor insulation class according to IEC/EN 60034-11,
- the special characteristics of the motor, such as the conductor cross-section of the windings, the permissible overload factor, etc.
- special conditions prescribed by the user, such as the permissible ambient temperature, risks resulting from locked rotor, extent of permitted overload, etc.

One temperature sensor must be embedded in each phase winding. For instance, in case of three-phase squirrel cage motors, three sensors are embedded in the stator windings. For pole-changing motors with one winding (Dahlander connection), three sensors are also required. Pole-changing motors with two windings, however, require six sensors. If an additional warning is required before the motor is switched off, separate sensors for a correspondingly lower temperature must be embedded in the winding. They have to be connected to a second control unit.

The sensors are suitable for embedding in motor windings with rated operating voltages of up to 600 V AC. Conductor length: 500 mm per sensor. A 14 V varistor can be connected in parallel to protect the sensors from overvoltage. Due to their characteristics, the thermistor motor protection relays can also be used with PTC temperature sensors of other manufacturers which comply with IEC/EN 60947-8.

Ordering details

CM-MSS accessories

Rated response temperature T_{NF}	Color coding	Type	Order code	Weight (1 pc) kg (lb)
70 °C	white-brown	C011-70 ¹⁾	GHC0110003R0001	0.02 (0.044)
80 °C	white-white	C011-80 ¹⁾	GHC0110003R0002	0.02 (0.044)
90 °C	green-green	C011-90 ¹⁾	GHC0110003R0003	0.02 (0.044)
100 °C	red-red	C011-100 ¹⁾	GHC0110003R0004	0.02 (0.044)
110 °C	brown-brown	C011-110 ¹⁾	GHC0110003R0005	0.02 (0.044)
120 °C	gray-gray	C011-120 ¹⁾	GHC0110003R0006	0.02 (0.044)
130 °C	blue-blue	C011-130 ¹⁾	GHC0110003R0007	0.02 (0.044)
140 °C	white-blue	C011-140 ¹⁾	GHC0110003R0011	0.02 (0.044)
150 °C	black-black	C011-150 ¹⁾	GHC0110003R0008	0.02 (0.044)
160 °C	blue-red	C011-160 ¹⁾	GHC0110003R0009	0.02 (0.044)
170 °C	white-green	C011-170 ¹⁾	GHC0110003R0010	0.02 (0.044)
150 °C	black-black	C011-3-150 ²⁾	GHC0110033R0008	0.05 (0.11)

1) Temperature sensor C011, standard version acc. to IEC/EN 60947-8

2) Triple temperature sensor C011-3

Thermistor motor protection relays

Technical data - PTC temperature sensors C011

Characteristic data	Sensor type C011
Cold-state resistance	50 -100 Ω at 25 °C
Warm-state resistance ± 5 up to 6 K of rated response temperature T_{NF}	10 000 Ω
Thermal time constant, sensor open ¹⁾	< 5 s
Permitted ambient temperature	+180 °C

Rated response temperature \pm tolerance $T_{NF} \pm \Delta T_{NF}$	PTC resistance R from -20 °C to $T_{NF} - 20$ K	PTC resistance R ²⁾ at PTC temperatures of:		
		$T_{NF} - iT_{NF}$ (UPTC ≤ 2.5 V)	$T_{NF} + iT_{NF}$ (UPTC ≤ 2.5 V)	$T_{NF} + 15$ K (UPTC ≤ 7.5 V)
70 ± 5 °C	$\leq 100 \Omega$	$\leq 570 \Omega$	$\geq 570 \Omega$	-
80 ± 5 °C				
90 ± 5 °C		$\leq 550 \Omega$	$\geq 1330 \Omega$	$\geq 4000 \Omega$
100 ± 5 °C				
110 ± 5 °C				
120 ± 5 °C				
130 ± 5 °C				
140 ± 5 °C				
150 ± 5 °C				
160 ± 5 °C				
170 ± 7 °C			$\leq 570 \Omega$	$\geq 570 \Omega$

1) Not embedded in windings.

2) For triple temperature sensor take values $\times 3$.

Thermistor motor protection relays

Technical data - CM-MSS

Data at T_a = 25 °C and rated values, unless otherwise indicated

Type	CM-MSS.x1	CM-MSS.x2	CM-MSS.x3
Supply circuit - Input circuit			
Rated control supply voltage U _s	A1-A2	24-240 V AC/DC	24 V AC/DC
	A2-A3	-	-
Rated control supply voltage U _s tolerance	-15...+10 %		
Rated frequency	15-400 Hz	50-60 Hz	
Electrical insulation between supply circuit and measuring circuit	yes	no	yes
Power failure buffering time	20 ms		
Supply circuit - Measuring circuit / Sensor circuit			
Number of circuits	1 (CM-MSS.51: 2)		
Sensor type	PTC type A (IEC/EN 60947-8)		
Max. total resistance of sensors connected in series, cold state	< 750 Ω		
Overtemperature monitoring	switch-off resistance (relay de-energizes)	2.83 kΩ ± 1% (CM-MSS.12 /.13 /.22 /.23: 2.7 kΩ ± 5%)	
	switch-on resistance (relay energizes)	1.1 kΩ ± 1% (CM-MSS.12 /.13 /.22 /.23: 1.2 kΩ ± 5%)	
Maximum voltage in sensor circuit	1.33 kΩ	2.5 V	
	4 kΩ	3.7 V	
	∞ kΩ	5.5 V	
Maximum current in sensor circuit	3.7 mA		
Maximum sensor cable length	2 x 100 m at 0.75 mm ² , 2 x 400 m at 2.5 mm ²		
Accuracy within the rated control supply voltage tolerance	0.50 % (CM-MSS.12 /.13 /.22 /.23: 5 %)		
Accuracy within the temperature range	0.01 %/K (CM-MSS.12 /.13 /.22 /.23: 0.5 %/K)		
Repeat accuracy (constant parameters)	on request		
Reaction time of the safety function	< 100 ms		
Hardware fault tolerance (HFT)	0		
Control circuit			
Control function	see "Selection table CM-MSx range"		
Maximum no-load voltage	5.5 V		
Max. current	0.6 mA (CM-MSS.12 /.13 /.22 /.23: 1.2 mA)		
Maximum cable length	2 x 100 m at 0.75 mm ² , 2 x 400 m at 2.5 mm ²		
Indication of operational states			
Control supply voltage	U	LED green	
Relay status	R	LED yellow	
Fault message	F	LED red	
Output circuit			
Kind of output	see "Selection table CM-MSx range"		
Operating principle	closed-circuit principle		
Contact material	AgNi alloy, Cd free		
Rated operational voltage U _e (IEC/EN 60947-1)	250 V AC		
Minimum switching voltage / Minimum switching current	24 V / 10 mA		
Maximum switching voltage / Maximum switching current	see data sheet		
Rated operating current I _e (IEC/EN 60947-5-1)	AC-12 (resistive) at 230 V	4 A	
	AC-15 (inductive) at 230 V	3 A	
	DC-12 (resistive) at 24 V	4 A	
	DC-13 (inductive) at 24 V	2 A	
AC Rating (UL 508)	utilization category (Control Circuit Rating Code)	B 300	
	maximum rated operational voltage	300 V AC	
	maximum continuous thermal current at B 300	5 A	
	maximum making/breaking apparent power at B 300	3600/360 VA	
	general purpose rating	250 V AC - 4 A	
Mechanical lifetime	30 x 10 ⁶ switching cycles		
Electrical lifetime	at AC12, 230 V AC, 4 A	0.1 x 10 ⁶ switching cycles	
Maximum fuse rating to achieve short-circuit protection	n/c contact	10 A fast-acting (CM-MSS.12, CM-MSS.13, CM-MSS.51: 6 A)	
	n/o contact	10 A fast-acting	

Thermistor motor protection relays

Technical data - CM-MSS

Type	CM-MSS.x1	CM-MSS.x2	CM-MSS.x3
General data			
MTBF	on request		
Duty time	100 %		
Dimensions	see "Dimensional drawings"		
Mounting	DIN rail (IEC/EN 60715), snap-on mounting without any tool		
Mounting position	any		
Minimum distance to other units	vertical / horizontal	10 mm (0.394 in) if switching current > 2 A	
Material of housing	UL 94 V-0		
Degree of protection	housing	IP50	
	terminals	IP20	
Electrical connection		Screw connection technology	Easy Connect Technology (push-in)
Connection capacity	fine-strand with(out) wire end ferrule	1 x 0.5-2.5 mm ² (1 x 18-14 AWG)	2 x 0.5-1.5 mm ² (2 x 18-16 AWG)
		2 x 0.5-1.5 mm ² (2 x 18-16 AWG)	
	rigid	1 x 0.5-4 mm ² (1 x 20-12 AWG) 2 x 0.5-2.5 mm ² (2 x 20-14 AWG)	2 x 0.5-1.5 mm ² (2 x 20-16 AWG)
Stripping length	8 mm (0.32 in)		
Tightening torque	0.6-0.8 Nm (7.08 lb.in)		-
Environmental data			
Ambient temperature ranges	operation	-25...+60 °C (-13...+140 °F)	
	storage	-40...+85 °C (-40...+185 °F)	
Damp heat, cyclic (IEC/EN 60068-2-30)	6 x 24 h cycle, 55 °C, 95 % RH		
Climatic class (IEC/EN 60721-3-3)	3K5 (no condensation, no ice formation)		
Vibration, sinusoidal	5-13.2 Hz: ±1 mm; 13.2-100 Hz: 0.7 g		
Shock	Class 2		
Isolation data			
Rated insulation voltage U _i	Supply circuit / Measuring circuit ¹⁾	300 V AC (CM-MSS.x2: n/a)	
	Supply circuit / Output circuits	300 V AC	
	Measuring circuit (1) / Output circuits	300 V AC	
	Output circuit 1 / Output circuit 2	300 V AC	
Rated impulse withstand voltage U _{imp}	Supply circuit / Measuring circuit ¹⁾	4 kV (CM-MSS.x2: n/a)	
	Supply circuit / Output circuits	4 kV	
	Measuring circuit (1) / Output circuits	4 kV	
	Output circuit 1 / Output circuit 2	4 kV	
Basic insulation	Supply circuit / Measuring circuit ¹⁾	600 V AC (CM-MSS.x2: n/a)	
	Supply circuit / Output circuits	600 V AC	
	Measuring circuit (1) / Output circuits	600 V AC	
	Output circuit 1 / Output circuit 2	300 V AC	
Protective separation (IEC/EN 61140)	Supply circuit / Measuring circuit ¹⁾	yes, up to 300 V	
	Supply circuit / Output circuits	yes (CM-MSS.x2: n/a)	
	Measuring circuit (1) / Output circuits	yes	
	Output circuit 1 / Output circuit 2	no	
Pollution degree (IEC/EN 60664-1)	3		
Overvoltage category (IEC/EN 60664-1)	III		
¹⁾ Potential of measuring circuit = Potential of control circuit			
Standards			
Product standard	EN 60947-5-1, EN 60947-8		
Low Voltage Directive	2014/35/EU		
EMC directive	2014/30/EU		
ATEX directive	2014/34/EU (only ATEX variants, see "Selection table CM-MSx range")		
RoHS directive	2011/65/EU		

Thermistor motor protection relays

Technical data - CM-MSS

Type	CM-MSS.x1	CM-MSS.x2	CM-MSS.x3
Electromagnetic compatibility			
Interference immunity to		IEC/EN 61000-6-2, IEC/EN 60947-8	
electrostatic discharge	IEC/EN 61000-4-2	Level 3, 6 kV contact discharge, 8 kV air discharge	
radiated, radio-frequency, electromagnetic field	IEC/EN 61000-4-3	Level 3, 10 V/m (1 GHz), 3 V/m (2 GHz), 1 V/m (2.7 GHz)	
electrical fast transient / burst	IEC/EN 61000-4-4	Level 3, 2 kV / 5 kHz	
surge	IEC/EN 61000-4-5	Level 3, Installation class 3, supply circuit and measuring circuit 1 kV L-L, 2 kV L-N	
conducted disturbances, induced by radio-frequency fields	IEC/EN 61000-4-6	Level 3, 0.15-80 MHz, 10 V, 80 % AM (1kHz)	
voltage dips, short interruptions and voltage variations	IEC/EN 61000-4-11	Class 3	
harmonics and interharmonics	IEC/EN 61000-4-13	Class 3	
Additional interference immunity according to product standard IEC/EN 60255-1 (reference on IEC/EN 60255-26)			
radiated, radio-frequency, electromagnetic field	IEC/EN 61000-4-3	10 V/m (80 MHz - 3 GHz)	
conducted disturbances, induced by radio-frequency fields	IEC/EN 61000-4-6	10 V at stated frequencies	
damped oscillatory waves	IEC/EN 61000-4-18	Signal lines, symmetric coupling: 1 kV peak voltage Power supply, asymmetric coupling: 2.5 kV peak voltage	
Interference emissions		IEC/EN 61000-6-3	
high-frequency radiated	IEC/CISPR 22, EN 55022	Class B	
high-frequency conducted	IEC/CISPR 22, EN 55022	Class B	
high-frequency radiated	Germanischer Lloyd	increased requirements in the emergency call frequency band	

Thermistor motor protection relays

Technical data - CM-MSE

Data at $T_a = 25\text{ °C}$ and rated values, unless otherwise indicated

Type	CM-MSE	
Supply circuit - Input circuit		
Rated control supply voltage U_s power consumption	1SVR550805R9300	24 V AC approx. 1.5 A
	1SVR550800R9300	110-130 V AC approx. 1.5 A
	1SVR550801R9300	220-240 V AC approx. 1.5 A
Rated control supply voltage U_s tolerance	-15...+10 %	
Rated frequency	50-60 Hz	
Measuring circuit		
Monitoring function	T1-T2	temperature monitoring by means of PTC sensors
Number of sensor circuits	1	
Sensor circuit		
Sensor type	PTC type A (IEC/EN 60947-8)	
Max. total resistance of sensors connected in series, cold state	≤1.0 kΩ	
Overtemperature monitoring	switch-off resistance (relay de-energizes)	2.0-3.0 kΩ
	switch-on resistance (relay energizes)	1.2-1.65 kΩ
Maximum voltage in sensor circuit	4 kΩ	5 V
	∞ kΩ	15 V
Maximum current in sensor circuit	2 mA	
Maximum sensor cable length	2 x 100 m at 0.75 mm ² , 2 x 400 m at 2.5 mm ²	
Reaction time	<100 ms	
Output circuit		
Kind of output	13-14	1 n/o contact
Operational principle	closed-circuit principle (output relay de-energizes if the measured value exceeds/drops below the adjusted threshold)	
Maximum switching voltage	250 V	
Rated operating voltage U_e and rated operating current I_e	AC-12 (resistive) at 230 V	4 A
	AC-15 (inductive) at 230 V	3 A
	DC-12 (resistive) at 24 V	4 A
	DC-13 (inductive) at 24 V	2 A
AC Rating (UL 508)	utilization category (Control Circuit Rating Code)	B 300
	maximum rated operational voltage	300 V AC
	maximum continuous thermal current at B 300	5 A
	maximum making/breaking apparent power at B 300	3600/360 VA
	general purpose rating	250 V AC - 4 A
Mechanical lifetime	30 x 10 ⁶ switching cycles	
Electrical lifetime	at AC12, 230 V AC, 4 A	0.1 x 10 ⁶ switching cycles
Maximum fuse rating to achieve short-circuit protection	n/c contact	10 A fast-acting
	n/o contact	10 A fast-acting
General data		
Dimensions	see "dimensional drawings"	
Duty cycle	100 %	
Mounting	DIN rail (IEC/EN 60715)	
Mounting position	any	
Degree of protection	housing / terminals	IP50 / IP20
Electrical connection		
Connecting capacity	fine strand with wire end ferrule	2 x 1.5 mm ² (2 x 16 AWG)
	fine strand without wire end ferrule	2 x 0.75-1.5 mm ² (2 x 18-16 AWG)
	rigid	2 x 1-1.5 mm ² (2 x 18-16 AWG)
Stripping length	2 x 0.75-1.5 mm ² (2 x 18-16 AWG)	
Tightening torque	0.6-0.8 Nm (5.31-7.08 lb.in)	
Environmental data		
Ambient temperature ranges	Operation	-20...+60 °C
	Storage	-40...+85 °C
Damp heat	IEC/EN 60068-2-30	40 °C, 93 % RH, 4 days
Vibration withstand	IEC/EN 60062-2-6	10-57 Hz: 0.075 mm; 57-150 Hz: 1 g

Thermistor motor protection relays

Technical data - CM-MSE























Type		CM-MSE
Isolation data		
Rated insulation voltage U_i	supply, measuring / output circuit	250 V
Rated impulse withstand voltage U_{imp}	between all isolated circuits	4 kV / 1.2 - 50 μ s
Pollution degree		3
Overvoltage category		III
Standards / Directives		
Standards		IEC/EN 60947-5-1, IEC/EN 60947-8
Low Voltage Directive		2014/35/EU
EMC Directive		2014/30/EU
RoHS Directive		2011/65/EU
Electromagnetic compatibility		
Interference immunity to		IEC/EN 61000-6-2, IEC/EN 60947-8
electrostatic discharge	IEC/EN 61000-4-2	Level 3, 6 kV contact discharge, 8 kV air discharge
radiated, radio-frequency, electromagnetic field	IEC/EN 61000-4-3	Level 3, 10 V/m (1 GHz), 3 V/m (2 GHz), 1 V/m (2.7 GHz)
electrical fast transient /burst	IEC/EN 61000-4-4	Level 3, 2 kV / 5 kHz
surge	IEC/EN 61000-4-5	Level 3, installation class 3, supply circuit and measuring circuit 1 kV L-L, 2 kV L-N
conducted disturbances, induced by radio-frequency fields	IEC/EN 61000-4-6	Level 3, 0.15-80 MHz, 10 V, 80 % AM (1kHz)
Interference emission		IEC/EN 61000-6-3
high-frequency radiated	IEC/CISPR 22, EN 55022	Class B
high-frequency conducted	IEC/CISPR 22, EN 55022	Class B

Thermistor motor protection relays

Technical data

LEDs, status information and fault messages

CM-MSS

Operational state	U: green LED	F: red LED	R: yellow LED
Absence of control supply voltage	OFF	OFF	OFF
Internal fault ²⁾	OFF		
Internal fault ²⁾			
Control supply voltage not within the tolerance range			OFF
Short circuit			OFF
Interrupted wire			OFF
Measuring circuit 2: Overtemperature			OFF
Measuring circuit 1: Overtemperature			OFF
Fault rectified but not confirmed		- ¹⁾	
Test function		OFF	OFF
Change of configuration not confirmed		OFF	
No fault		OFF	

1) Depending on the fault with the highest priority

2) Restart the device. If after restart the same fault is indicated, replace the device.

Thermistor motor protection relays

Technical diagrams

Connection diagrams

CM-MSS.11x, CM-MSS.21x

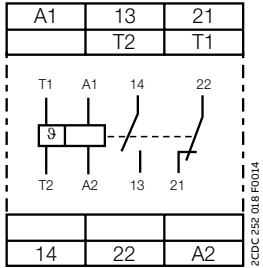

A1 – A2	Control supply voltage
13 – 14	n/o contact
21 – 22	n/c contact
T1 – T2	Measuring circuit

CM-MSS.12x

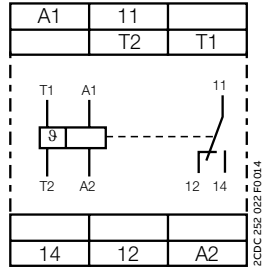

A1 – A2	Control supply voltage
11 – 12/14	c/o contact
T1 – T2	Measuring circuit

CM-MSS.13x

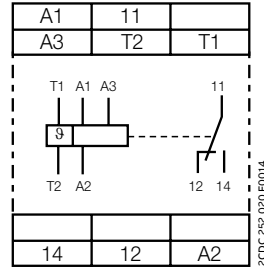

A1 – A2	Control supply voltage 220-240 V AC
A2 – A3	Control supply voltage 110-130 V AC
11 – 12/14	c/o contact
T1 – T2	Measuring circuit

CM-MSS.31x

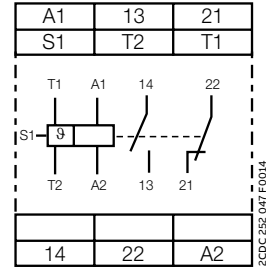

A1 – A2	Control supply voltage
13 – 14	n/o contact
21 – 22	n/c contact
S1 – T2	Automatic reset (jumpered)
T1 – T2	Measuring circuit

CM-MSS.22x, CM-MSS.32x, CM-MSS.41x

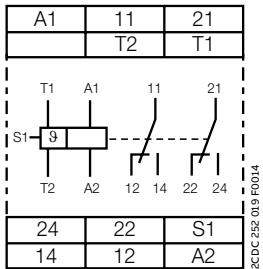

A1 – A2	Control supply voltage 24 V AC/DC
11 – 12/14	1st c/o (SPDT) contact
21 – 22/24	2nd c/o (SPDT) contact
S1 – T2	Automatic reset (jumpered)
T1 – T2	Measuring circuit

CM-MSS.23x, CM-MSS.33x

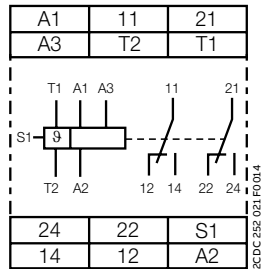

A1 – A2	Control supply voltage 220-240 V AC
A2 – A3	Control supply voltage 110-130 V AC
11 – 12/14	1st c/o (SPDT) contact
21 – 22/24	2nd c/o (SPDT) contact
S1 – T2	Automatic reset (jumpered)
T1 – T2	Measuring circuit

CM-MSS.51x

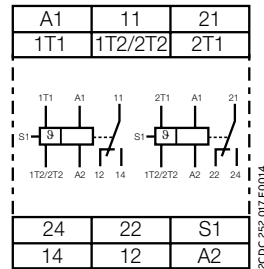

A1 – A2	Control supply voltage 220-240 V AC
11 – 12/14	1st c/o (SPDT) contact
21 – 22/24	2nd c/o (SPDT) contact
S1 – 1T2/2T2	Automatic reset (jumpered)
1T1 – 1T2/2T2	Measuring circuit 1
2T1 – 1T2/2T2	Measuring circuit 2

CM-MSE

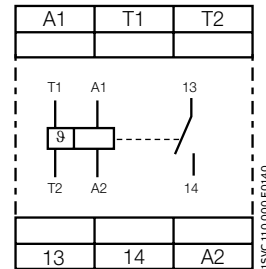

A1 – A2	Control supply voltage 24 V AC
T1-T2	Sensor circuit
13-14	Output contact - Closed circuit principle

Thermistor motor protection relays

Technical diagrams

Circuit diagrams

CM-MSS.11x, CM-MSS.21x

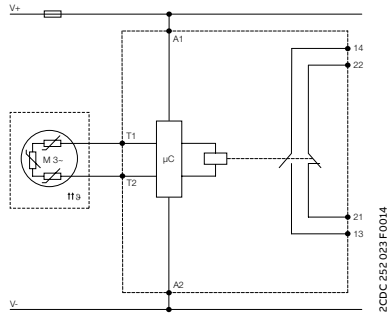

CM-MSS.12x

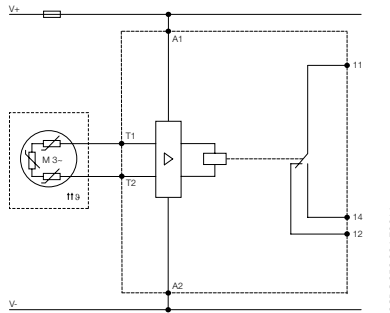

CM-MSS.13x

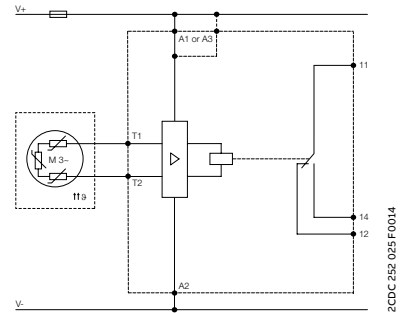

CM-MSS.22x

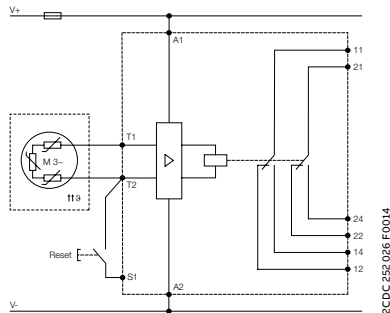

CM-MSS.23x

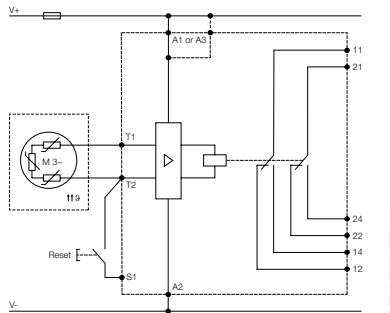

CM-MSS.31x

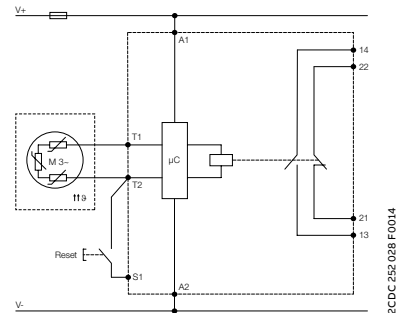

CM-MSS.32x, CM-MSS.41x

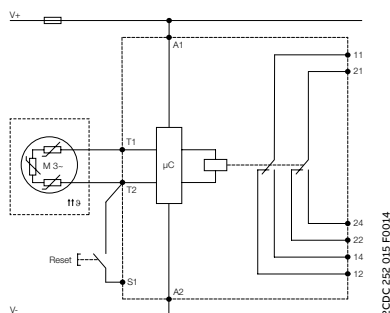

CM-MSS.33x

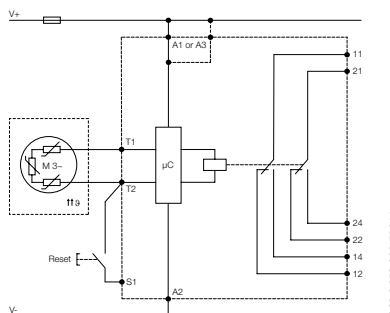

CM-MSS.51x

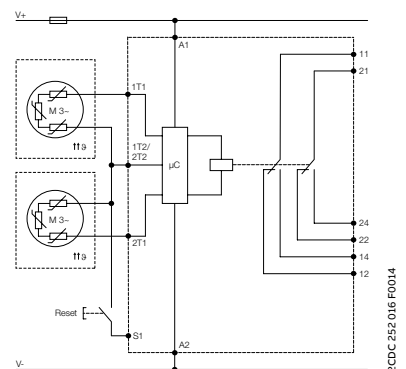

CM-MSE

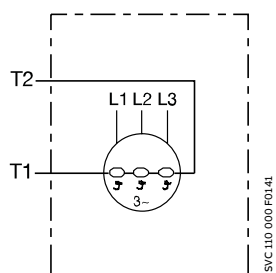



Temperature monitoring relays with potentiometer

Table of contents

204	Benefits and advantages
205	Applications
207	Operating controls
208	Selection table
209	Ordering details
210	Configuration and setup
212	Technical data
215	Technical diagrams
216	Function diagrams

Temperature monitoring relays with potentiometer

Benefits and advantages



The temperature monitoring relays of the CM-TCS range are able to measure temperatures of solids, liquids and gaseous media using PT100 sensors. Over-temperature and undertemperature monitoring, as well as open- or closed-circuit principle is configurable for all devices. As soon as the temperature falls below or exceeds the set threshold value, the output relays change their positions and the front-face LED's display the current status.

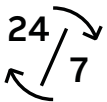

Continuous operation

By using temperature monitoring relays, both the downtime and the commissioning time can be reduced. The relay is continuously monitoring the sensor circuit to detect short-circuit or interrupted wire faults. The high accuracy of the measuring input leads to a fast detection of exceeding threshold values. In case of fault, maintenance effort is reduced and time saved.



Reliable in harsh conditions

All relays work reliably in environments with low temperatures down to -40 °C. Additionally, the housing fulfills the UL 94 V-0 flammability standard requirements. Together with the vibration resistant push-in terminals, the relay is not only reliable no matter the environment temperature but is also durable to shock and vibration. Save time as retightening is no longer needed and enhance the reliability and safety not only for the equipment.



Easy installation

Like all devices from the measuring and monitoring portfolio, the CM-TCS relays are easily configurable via front facing potentiometers. Easy threshold configuration without calculation is accomplished by direct reading scales. For further configuration options, additional settings can be made via dip-switches, offering the flexibility to configure, for example, the working principle of the relays and the output configuration. The device can be set up before installation in the application and easy adjustments during the process are possible.

Temperature monitoring relays with potentiometer Applications

The temperature monitoring relays CM-TCS monitor overtemperature, undertemperature, or temperatures between two threshold values (window monitoring) with a PT100 sensor.

As soon as the temperature falls below or exceeds the threshold value, the output relays change their positions according to the configured functionality.

The current status is displayed by front-faced LEDs. Regardless of the selected configuration, the device is monitoring its measuring circuit for interrupted wires or short-circuits.

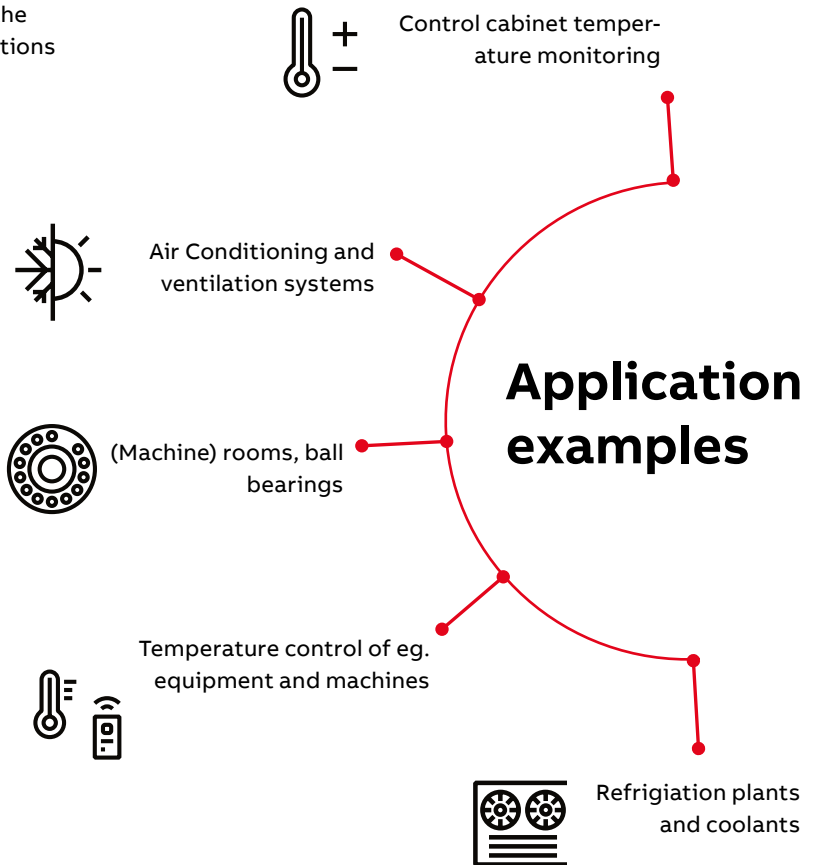



Temperature monitoring relays with potentiometer

Operating controls



Push-in and screw terminals



Measuring input: PT100



Adjustment of the threshold value
 - 50 ... + 50 °C
 0 ... + 100 °C
 0 ... + 200 °C

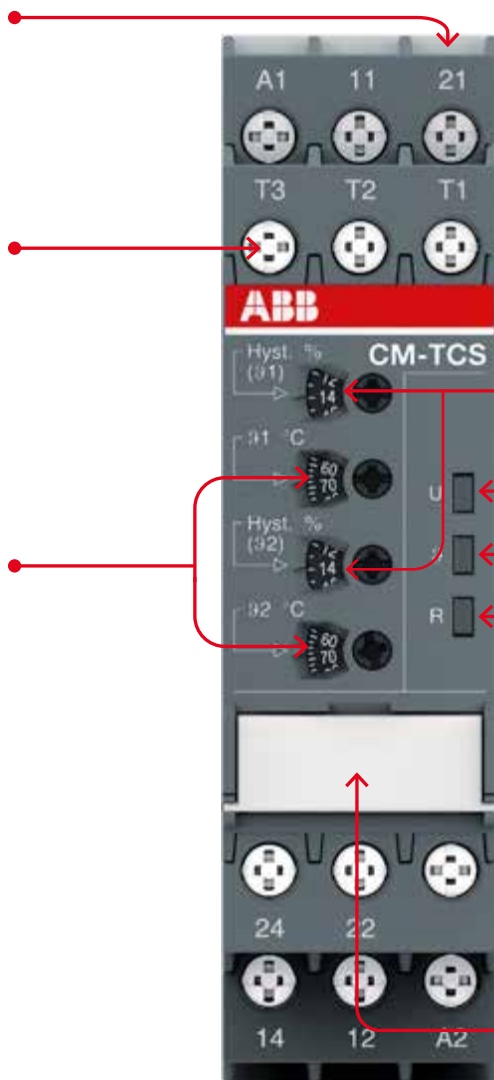

Adjustment of the hysteresis for threshold value 2 - 20 %



Indication of operational states
 U: green LED – status indication of control supply voltage
 9: red LED – fault message, state of measuring input
 R: yellow LED – status indication of the output relays



DIP switch functions / marker label

- Overtemperature monitoring
- Undertemperature monitoring
- Temperature window monitoring activated
- Temperature window monitoring de-activated
- Closed-circuit principle
- Open-circuit principle
- 2 x 1 c/o (SPDT) contact
- 1 x 2 c/o (SPDT) contacts

Temperature monitoring relays with potentiometer

Selection table

Type	Order number	1SVR 730 740 R9100	1SVR 740 740 R9100	1SVR 730 740 R0100	1SVR 740 740 R0100	1SVR 730 740 R9200	1SVR 740 740 R9200	1SVR 730 740 R0200	1SVR 740 740 R0200	1SVR 730 740 R9300	1SVR 740 740 R9300	1SVR 730 740 R0300	1SVR 740 740 R0300
CM-TCS.21S		■	■			■	■			■	■		
CM-TCS.21P				■	■			■	■			■	■
CM-TCS.11S													
CM-TCS.11P													
CM-TCS.22S													
CM-TCS.22P													
CM-TCS.12S													
CM-TCS.12P													
CM-TCS.23S										■	■	■	■
CM-TCS.23P													
CM-TCS.13S													
CM-TCS.13P													
Rated control supply voltage U_c													
24 V AC/DC		■	■			■	■			■	■		
24-240 V AC/DC				■	■			■	■			■	■
Sensor circuits (2 or 3 wire)													
Number of temperature sensors		1	1	1	1	1	1	1	1	1	1	1	1
Number of thresholds		2	2	2	2	2	2	2	2	2	2	2	2
Measuring temperature range													
-50...+50 °C		■	■	■	■								
0...+100 °C						■	■	■	■				
0...+200 °C										■	■	■	■
Monitoring function													
Overtemperature		■	■	■	■	■	■	■	■	■	■	■	■
Undertemperature		■	■	■	■	■	■	■	■	■	■	■	■
Window temperature		■	■	■	■	■	■	■	■	■	■	■	■
Operating principle													
Open or closed-circuit principle		■	■	■	■	■	■	■	■	■	■	■	■
Output contacts													
c/o		2	2	2	2	2	2	2	2	2	2	2	2



Temperature monitoring relays with potentiometer

Ordering details



CM-TCS

Description CM-TCS

The temperature monitoring relays CM-TCS are able to measure temperatures of solids, liquids and gaseous media using PT100 sensors. Overtemperature and undertemperature monitoring, as well as open- or closed-circuit principle, is configurable for all devices. As soon as the temperature falls below or exceeds the set threshold value, the output relays change their positions according to the configured functionality and the front-face LEDs display the current status.

Ordering details

Temperature monitoring relays CM-TCS

Rated control supply voltage	Measuring range	Temperature sensors	Type	Order code	Weight (1 pc) kg (lb)
24-240 V AC/DC	-50...+50 °C	PT100	CM-TCS.11S	1SVR730740R0100	0.151 (0.333)
			CM-TCS.11P	1SVR740740R0100	0.140 (0.309)
	0...+100 °C		CM-TCS.12S	1SVR730740R0200	0.151 (0.333)
	CM-TCS.12P		1SVR740740R0200	0.140 (0.309)	
	0...+200 °C		CM-TCS.13S	1SVR730740R0300	0.151 (0.333)
	CM-TCS.13P		1SVR740740R0300	0.140 (0.309)	
24 V AC/DC	-50...+50 °C	CM-TCS.21S	1SVR730740R9100	0.138 (0.304)	
		CM-TCS.21P	1SVR740740R9100	0.127 (0.280)	
	0...+100 °C	CM-TCS.22S	1SVR730740R9200	0.138 (0.304)	
	CM-TCS.22P	1SVR740740R9200	0.127 (0.280)		
	0...+200 °C	CM-TCS.23S	1SVR730740R9300	0.138 (0.304)	
	CM-TCS.23P	1SVR740740R9300	0.127 (0.280)		

S: screw connection
P: push-in connection



Temperature monitoring relays with potentiometer

Configuration and setup

DIP switches

Position	4	3	2	1
ON ↑				
OFF				

	ON	OFF (default)
DIP switch 1 Monitoring principle	Overtemperature monitoring If overtemperature monitoring is selected, the CM-TCS recognizes temperatures above the selected threshold and trips the output relay according to the selected operating principle.	Undertemperature monitoring If undertemperature monitoring is selected, the CM-TCS recognizes temperatures below the selected threshold and trips the output relay according to the selected operating principle.
DIP switch 2 Temperature window monitoring	Temperature window monitoring activated If temperature window monitoring is selected, the CM-TCS monitors over- and undertemperature. If temperature window monitoring is activated, DIP switch 1 is disabled.	Temperature window monitoring de-activated Temperature window monitoring is de-selected.
DIP switch 3 Operating principle of the output relays	Closed-circuit principle If closed-circuit principle is selected, the output relays are energized. They de-energize if a fault is occurring.	Open-circuit principle If open-circuit principle is selected, the output relays are deenergized. They energize if a fault is occurring.
DIP switch 4 2 x 1 c/o contact, 1 x 2 c/o contacts	2 x 1 c/o (SPDT) contact If operating principle 2 x 1 c/o contact is selected, the output relay R1 (11-12/14) reacts to threshold value ϑ_1 and the output relay R2 (21-22/24) reacts to threshold value ϑ_2 .	1 x 2 c/o (SPDT) contacts If operating principle 1 x 2 c/o contacts is selected, both output relays R1 (11-12/14) and R2 (21-22/24) react synchronously to one threshold value. Overtemperature monitoring: Settings of the threshold value ϑ_2 have no effect on the operation. Undertemperature monitoring: Settings of the threshold values ϑ_2 have no effect on the operation.

Temperature monitoring relays with potentiometer

Configuration and setup

Connection of resistance thermometer sensors

2-wire measurement

When using 2-wire temperature sensors, the sensor resistance and the wire resistance are added together. The resulting systematic errors must be taken into account when adjusting the tripping device. A jumper must be connected between the terminals T2 and T3. The following table can be used for PT100 sensors to determine the temperature errors caused by the line length. When using resistance sensors with two-wire connection a bridge must be inserted between terminals T2 and T3.

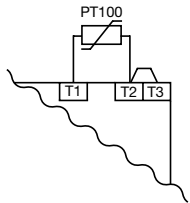

3-wire measurement

To minimize the influence of the wire resistance, a three-wire connection is usually used. By means of the additional wire, two measuring circuits are created. One of these two circuits is used for reference. This way, the tripping device can calculate and take into account the wire resistance automatically.

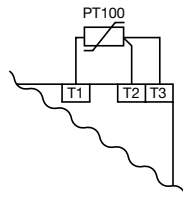

Temperature error

(depending on the line length and conductor cross section for PT100 sensors at an ambient temperature of 20 °C, in K)

Line length in m	Wire size mm ²			
	0.50	0.75	1	1.5
0	0.0	0.0	0.0	0.0
10	1.8	1.2	0.9	0.6
25	4.5	3.0	2.3	1.5
50	9.0	6.0	4.5	3.0
75	13.6	9.0	6.8	4.5
100	18.1	12.1	9.0	6.0
200	36.3	24.2	18.1	12.1
500	91.6	60.8	45.5	30.2

Error caused by the line

The error resulting from the line resistance amounts to approx. 2.5 Kelvin/Ohm. If the resistance of the line is not known and it is not possible to measure it, the error caused by the line can be estimated using the following table.

Temperature monitoring relays with potentiometer

Technical data

Type		CM-TCS.11/12/13	CM-TCS.21/22/23
Input circuit			
Rated control supply voltage U_s	A1-A2	24-240 V AC/DC	24 V AC/DC
Rated control supply voltage U_s tolerance		-15...+10 %	
Typical current / power / consumption	24 V DC	33 mA / 0.8 VA	18 mA / 0.45 VA
	115 V AC	12.5 mA / 1.5 VA	n/a
	230 V AC	13 mA / 2.9 VA	n/a
Rated frequency	AC	15-400 Hz	50/60 Hz
Frequency range	AC	13.5-440 Hz	45-65 Hz
Power failure buffering time	min.	20 ms	
Measuring circuit		T1, T2, T3	
Sensor type		PT100	
Connection of the sensor	2-wire	yes, jumper between T2-T3	
	3-wire	yes, use terminal T1, T2, T3	
Monitoring function		overtemperature, undertemperature or window monitoring	
Threshold values adjustable within the measuring range	CM-TCS.x1	-50...+50 °C	
	CM-TCS.x2	0...+100 °C	
	CM-TCS.x3	0...+200 °C	
Number of possible thresholds		2	
Tolerance of the adjusted threshold value		typ. ±5 % of the range end value	
Hysteresis related to the threshold value		2-20 % of threshold value, min. 1 °C	
Measuring principle		continuous current	
Typical current in the sensor circuit		0.8 mA	
Maximum current in sensor circuit		0.9 mA	
Interrupted wire detection		yes, indicated via LED status	
Short-circuit detection		yes, indicated via LED status	
Accuracy within the rated control supply voltage tolerance		< 0.2 °C / or < 0.01 %/K	
Accuracy within the temperature range		< 0.2 °C / or < 0.01 %/K	
Repeat accuracy (constant parameters)		< 0.2 % of full scale	
Maximum measuring cycle		320 ms	
Output circuit			
Kind of output		2 x 1 or 1 x 2 c/o (SPDT) contacts configurable	
Operating principle		open- or closed-circuit principle configurable (1)	
Contact material		AgNi alloy, Cd free	
Minimum switching voltage / Minimum switching current		24 V / 10 mA	
Maximum switching voltage / Maximum switching current		see 'Load limit curves'	
Rated operational voltage U_o and rated operational current I_o	AC-12 (resistive) 230 V	4 A	
	AC-15 (inductive) 230 V	3 A	
	DC-12 (resistive) 24 V	4 A	
	DC-13 (inductive) 24 V	2 A	
AC Rating (UL508)	utilization category	B 300 pilot duty; general purpose 250 V, 4 A, $\cos \varphi$ 0.75	
	maximum rated operational voltage	250 V AC	
	maximum continuous thermal current at B 300	4 A	
	maximum making/breaking apparent power at B 300	3600/360 VA	
Mechanical lifetime		30 x 10 ⁶ switching cycles	
Electrical lifetime (AC-12, 230 V, 4 A)		0.1 x 10 ⁶ switching cycles	
Maximum fuse rating to achieve short-circuit protection	n/c contact	6 A fast-acting	
	n/o contact	10 A fast-acting	
Conventional thermal current I_{th}		4 A	

⁽¹⁾ Closed-circuit principle: Output relay(s) de-energize(s) if measured value exceeds or falls below the adjusted threshold value

Temperature monitoring relays with potentiometer

Technical data

Type		CM-TCS.11/12/13	CM-TCS.21/22/23
General data			
Dimensions		see "dimensional drawings"	
Mounting		DIN rail (IEC/EN 60715), snap-on mounting without any tool	
Mounting position		any	
Degree of protection	enclosure / terminals	IP50 / IP20	
Ambient temperature range	operation	-40...+60 °C	
	storage /transport	-40...+85 °C	
Electrical connection			
Wire size		Screw connection technology	Easy Connect Technology (Push-in)
fine-strand without wire end ferrule	A1, A2, 11, 12, 14, 21, 22, 24	1 x 0.5-2.5 mm ² (1 x 20-14 AWG) 2 x 0.5-1.5 mm ² (2 x 20-16 AWG)	2 x 0.5-1.5 mm ² (2 x 20-16 AWG) connection with lever
	T1, T2, T3	1 x 0.2-2.5 mm ² (1 x 24-14 AWG) 2 x 0.2-1.5 mm ² (2 x 24-16 AWG)	2 x 0.2-1.5 mm ² (2 x 24-16 AWG) connection with lever
fine-strand with wire end ferrule	A1, A2, 11, 12, 14, 21, 22, 24	1 x 0.5-2.5 mm ² (1 x 20-14 AWG) 2 x 0.5-1.5 mm ² (2 x 20-16 AWG)	2 x 0.5-1.5 mm ² (2 x 20-16 AWG) connection: push-in
	T1, T2, T3	1 x 0.2-2.5 mm ² (1 x 24-14 AWG) 2 x 0.2-1.5 mm ² (2 x 24-16 AWG)	2 x 0.2-1.5 mm ² (2 x 24-16 AWG) insulated ferrule (DIN 46228-4-E): connection: push-in ferrule (DIN 46228-1-A): < 0.5 mm ² , connection with lever ≥ 0.5 mm ² , connection: push-in
rigid	A1, A2, 11, 12, 14, 21, 22, 24	1 x 0.5-4 mm ² (1 x 20-12 AWG) 2 x 0.5-2.5 mm ² (2 x 20-14 AWG)	2 x 0.5-1.5 mm ² (2 x 20-16 AWG) connection: push-in
	T1, T2, T3	1 x 0.2-4 mm ² (1 x 24-12 AWG) 2 x 0.2-2.5 mm ² (2 x 24-14 AWG)	2 x 0.2-1.5 mm ² (2 x 24-16 AWG) < 0.5 mm ² , connection with lever ≥ 0.5 mm ² , connection: push-in
Stripping length		8 mm (0.32 In)	
Tightening torque	< 0.5 mm ²	0.5 Nm (4.43 lb.In)	-
	≥ 0.5 mm ²	0.6 - 0.8 Nm (5.31 - 7.08 lb.In)	-
Standards / Directives			
Standards		IEC/EN 60255-27, IEC/EN 60947-5-1	
Low Voltage Directive		2014/35/EU	
EMC Directive		2014/30/EU	
RoHS Directive		2011/65/EU	
Environmental data			
Ambient temperature ranges	operation/storage/ transport	-40...+60 °C/-40...+85 °C/-40...+85 °C	
Climatic class	IEC/EN 60721-3-3	3K5 (no condensation, no ice formation)	
Damp heat, cyclic	IEC/EN 60068-2-30	6 x 24 h cycle, 55 °C, 95 % RH	
Vibration, sinusoidal		Class 2	
Shock		Class 2	
Isolation data			
Rated impulse withstand voltage U _{imp}	supply circuit / measuring circuit	4 kV	-
	supply circuit / output circuits	4 kV	
	measuring circuit / output circuits	4 kV	
	output circuit 1 / output circuit 2	4 kV	
Rated insulation voltage U _i	supply circuit / measuring circuit	300 V	-
	supply circuit / output circuits	300 V	
	measuring circuit / output circuits	300 V	
	output circuit 1 / output circuit 2	300 V	

Temperature monitoring relays with potentiometer

Technical data

Type		CM_TCS.11/12/13	CM-TCS.21/22/23
Basis insulation	supply circuit / measuring circuit	250 V AC / 300 V DC	-
	supply circuit / output circuits	250 V AC / 300 V DC	
	measuring circuit / output circuits	250 V AC / 300 V DC	
	output circuit 1 / output circuit 2	250 V AC / 300 V DC	
Protective separation (IEC/EN 61140)	supply circuit / measuring circuit	250 V AC / 250 V DC	-
	supply circuit / output circuits	250 V AC / 300 V DC	250 V AC / 250 V DC
	measuring circuit / output circuits	250 V AC / 300 V DC	250 V AC / 250 V DC
Pollution degree		3	
Overvoltage category		III	
Electromagnetic compatibility			
Interference immunity to		IEC/EN 61000-6-2	
electrostatic discharge	IEC/EN 61000-4-2	Level 3, 6 kV / 8 kV	
radiated, radio-frequency, electromagnetic field	IEC/EN 61000-4-3	Level 3, 10 V/m (1 GHz) / 3 V/m (2 GHz) / 1 V/m (2.7 GHz)	
electrical fast transient/burst	IEC/EN 61000-4-4	Level 3, 2 kV / 5 kHz	
surge	IEC/EN 61000-4-5	Level 3, installation class 3, supply circuit and measuring circuit 1 kV L-L, 2 kV L-earth	
conducted disturbances, induced by radio-frequency fields	IEC/EN 61000-4-6	Level 3, 10 V	
voltage dips, short interruptions and voltage variations	IEC/EN 61000-4-11	Class 3	
harmonics and interharmonics	IEC/EN 61000-4-13	Class 3	
Interference emission		IEC/EN 61000-6-3	
high-frequency radiated	IEC/CISPR 22, EN 55022	Class B	
high-frequency conducted	IEC/CISPR 22, EN 55022	Class B	

Temperature monitoring relays with potentiometer

Technical diagrams

Connection diagram

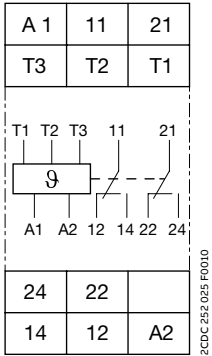

A1 – A2	Control supply voltage
11 – 12/14	Output relay R1
21 – 22/24	Output relay R2
T1, T2, T3	Measuring input, connection PT100

Dimensional drawing in mm and inches

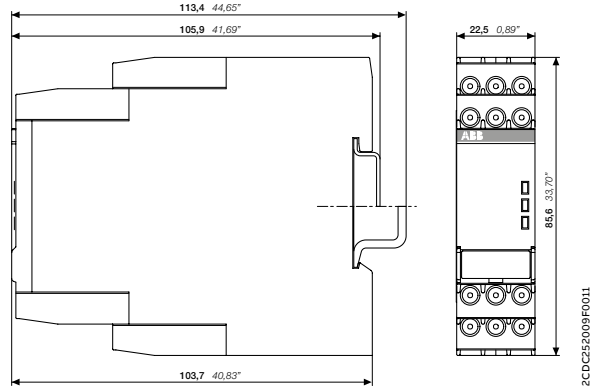

Electrical isolation

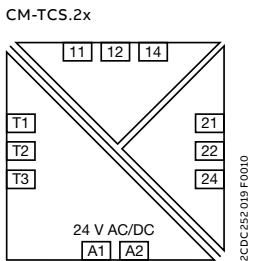

Electrical isolation

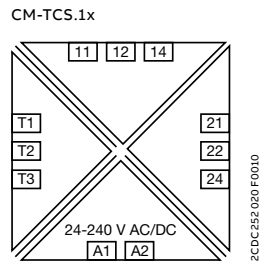

Protective separation acc. to IEC/EN 61140

Temperature monitoring relays with potentiometer

Function diagrams

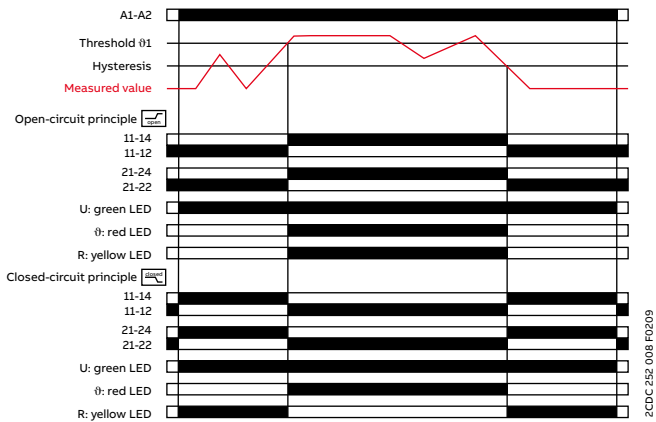

Overtemperature monitoring, 1 x 2 c/o contacts [1x2 c/o]

With this configuration, settings via ϑ2 have no influence on the operating function (ϑ2 disabled).

Open-circuit principle:

If the measured value is correct, the output relays remain de-energized when control supply voltage is applied. If the measured value exceeds the adjusted threshold value ϑ1, the output relays energize. If the measured value drops again below the adjusted threshold value ϑ1 minus the adjusted hysteresis, the output relays de-energize.

Closed-circuit principle:

The behavior is inverse to the one with open-circuit principle.

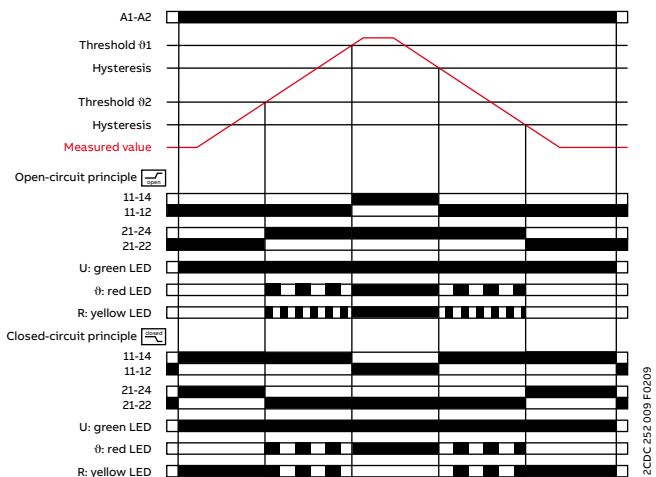

Overtemperature monitoring, 2 x 1 c/o contact [2x1 c/o]

Open-circuit principle:

If the measured value is correct, the output relays remain de-energized when control supply voltage is applied. If the measured value exceeds the adjusted threshold value ϑ2, output relay R2 (prewarning) energizes. If the measured value exceeds the adjusted threshold value ϑ1, output relay R1 (final switch-off) energizes.

If the measured value drops again below the adjusted threshold value ϑ1 minus the adjusted hysteresis, output relay R1 (final switch-off) de-energizes. If the measured value drops below the adjusted threshold value ϑ2 minus the adjusted hysteresis, output relay R2 (prewarning) de-energizes.

Closed-circuit principle:

The behavior is inverse to the one with open-circuit principle.

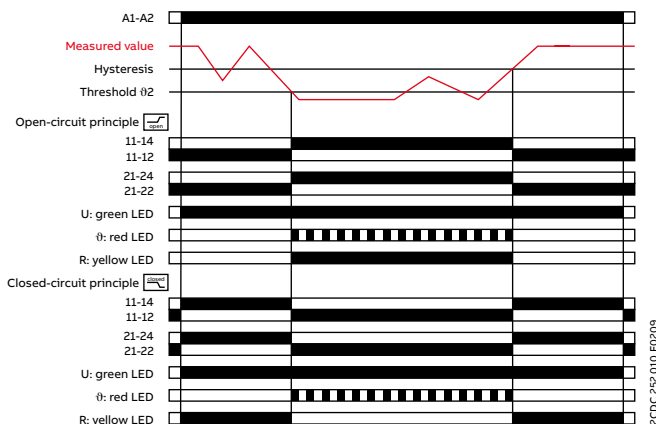

Undertemperature monitoring, 1 x 2 c/o contacts [1x2 c/o]

With this configuration, settings via ϑ1 have no influence on the operating function (ϑ1 disabled).

Open-circuit principle:

If the measured value is correct, the output relays remain de-energized when control supply voltage is applied. If the measured value drops below the adjusted threshold value ϑ2, the output relays energize. If the measured value exceeds again the adjusted threshold value ϑ2 plus the adjusted hysteresis, the output relays de-energize.

Closed-circuit principle:

The behavior is inverse to the one with open-circuit principle.

Temperature monitoring relays with potentiometer

Function diagrams

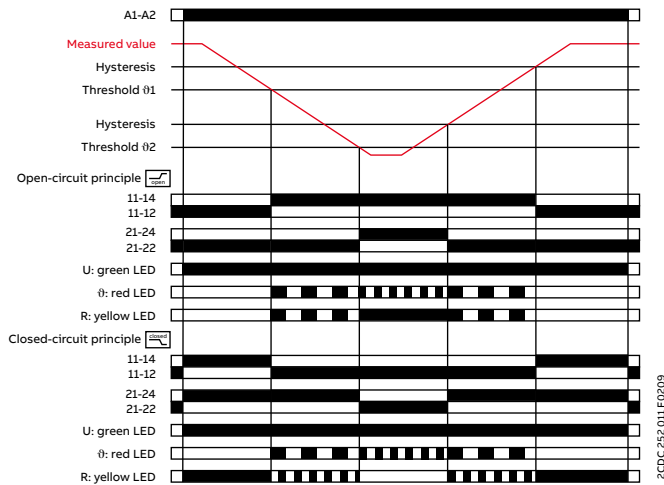

Open-circuit principle:
 If the measured value is correct, the output relays remain de-energized when control supply voltage is applied. If the measured value drops below the adjusted threshold value ϑ_1 , output relay R1 (prewarning) energizes. If the measured value drops below the adjusted threshold value ϑ_2 , output relay R2 (final switch-off) energizes. If the measured value exceeds again the adjusted threshold value ϑ_2 plus the adjusted hysteresis, output relay R2 (final switch-off) de-energizes. If the measured value exceeds the adjusted threshold value ϑ_1 plus the adjusted hysteresis, output relay R1 (prewarning) de-energizes.

Closed-circuit principle:
 The behavior is inverse to the one with open-circuit principle.

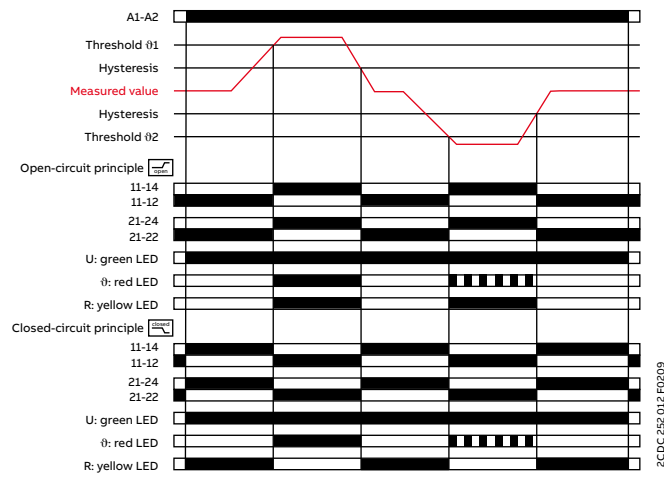

Open-circuit principle:
 If the measured value is correct, the output relays remain de-energized when control supply voltage is applied. If the measured value exceeds the adjusted threshold value ϑ_1 or drops below the adjusted threshold value ϑ_2 , the output relays energize. If the measured value drops again below the adjusted threshold value ϑ_1 minus the adjusted hysteresis or exceeds again the adjusted threshold value ϑ_2 plus the adjusted hysteresis, the output relays de-energize.

Closed-circuit principle:
 The behavior is inverse to the one with open-circuit principle.

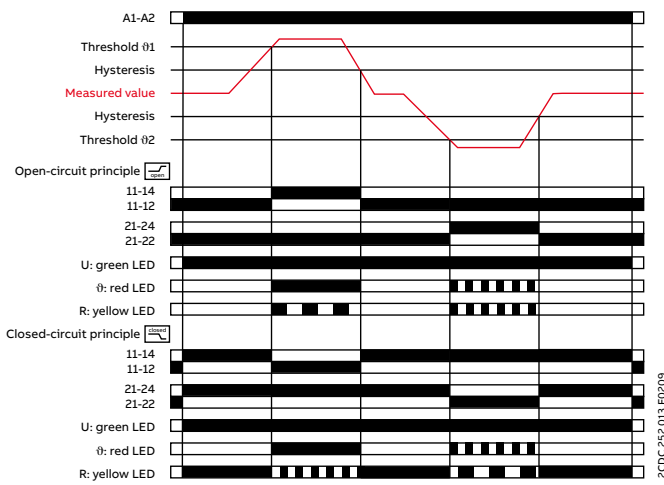

Open-circuit principle:
 If the measured value is correct, the output relays remain de-energized when control supply voltage is applied. If the measured value exceeds the adjusted threshold value ϑ_1 or drops below the adjusted threshold value ϑ_2 , output relay R1 ($> \vartheta_1$) or R2 ($< \vartheta_2$) respectively energizes. If the measured value drops again below the adjusted threshold value ϑ_1 minus the adjusted hysteresis or exceeds again the adjusted threshold value ϑ_2 plus the adjusted hysteresis, output relay R1 ($> \vartheta_1$) or R2 ($< \vartheta_2$) respectively de-energizes.

Closed-circuit principle:
 The behavior is inverse to the one with open-circuit principle.



Smart temperature monitoring relays

Table of contents

220	Features and benefits
225	Built-in connectivity
228	Applications
230	Selection table
231	Ordering details
232	Technical data
236	Technical diagrams

One look, one touch – one device

Features and benefits



Set up these innovative temperature monitoring relays exactly as you need, either via a back-lit LCD or smartphone app. Parametrization and configuration are just one touch away with the ABB EPiC app – even in a non-powered state – reducing installation time by 80%. And with just one relay covering a wide range of application, stocks can be reduced significantly, making ABB's Smart monitoring relays a true game changer.



Easy to install

One look - back-lit LCD for easy reading and parametrization

Everything you need at a glance: the LCD at the front of the relay shows the currently measured values and maintenance data. And with just one push, the symbol-based menu structure can be accessed via the push-rotate button. Simply set the thresholds and parameters with the help of an intuitive and future-ready interface.



Optimum interface

One touch - NFC parametrization via smartphone app

One touch is all that is needed for fast, easy and intuitive configuration with the ABB EPiC smartphone app. Simply touch the relay with your mobile phone: Parameter settings can be edited and stored in the app and then copied to different devices, even if they are not in the powered state. Available in a range of different languages, installation and configuration have never been so easy.



Continuous operation

One device - for thermal protection and condition monitoring

Smart temperature monitoring relays ensure that your application remains operational by detecting potential failures in advance. They protect the life of your assets by providing early detection of unacceptable temperature rises and the need for maintenance. The relay is configurable over a wide range of settings and can be adjusted flexibly. Set a pre-alarm and alarm thresholds according to application needs. Increase personal safety by monitoring temperature remotely with Modbus RTU or ABB Ability™ Energy and Asset Manager.

Smart temperature monitoring relays

Setup via display or smartphone app

CM-TCN temperature monitoring relays can measure temperatures of solids, liquids and gaseous media in up to three sensor circuits using various types of sensors.

One...



look to have the information needed

the display shows the measured values and relay status at a glance. The symbol-based menu structure and presets make parametrization simple.



touch for up to 80% faster setup

for easy parametrization and copying of settings between multiple devices via NFC with the ABB EPiC smartphone app – even if the relay is not powered.



device for thermal protection and condition monitoring

Just one relay to cover many different applications, monitor their condition, increase safety and ensure uptime.

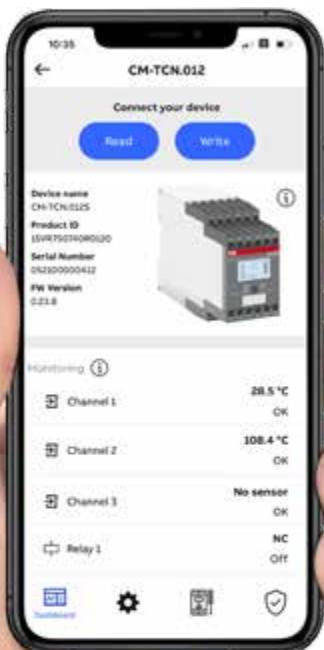

One look - back-lit LCD

Easy reading and setup with one push

Just one look is all it takes to see the status and measured values of the relay, easily navigate through the symbol-based menu and even configure the device with the new, back-lit LCD at the front of the relay.



Start screen

Know the status at one glance.



Symbol-based menu structure

Due to the symbol-based menu structure, there is no need for any translation, which helps avoid misunderstandings and dramatically increases efficiency in after sales support.



Pre- and user-defined settings

For frequently used applications, the device offers predefined settings to save installation time. Parameters can be individually set and saved in one of four user settings.



Push-rotate adjustment

Adjust the relay with a simple screw driver by pushing and rotating the potentiometer to navigate through the menu.



Back-lit LCD

The back-lit LCD at the front of the relay shows the currently measured values and maintenance data and makes setup easy.



Diagnostic data

Event history, operating hours counter, statistics and others are easily accessible from the menu



Password & parameter log

Improved security is achieved through the recorded password and parameter log.

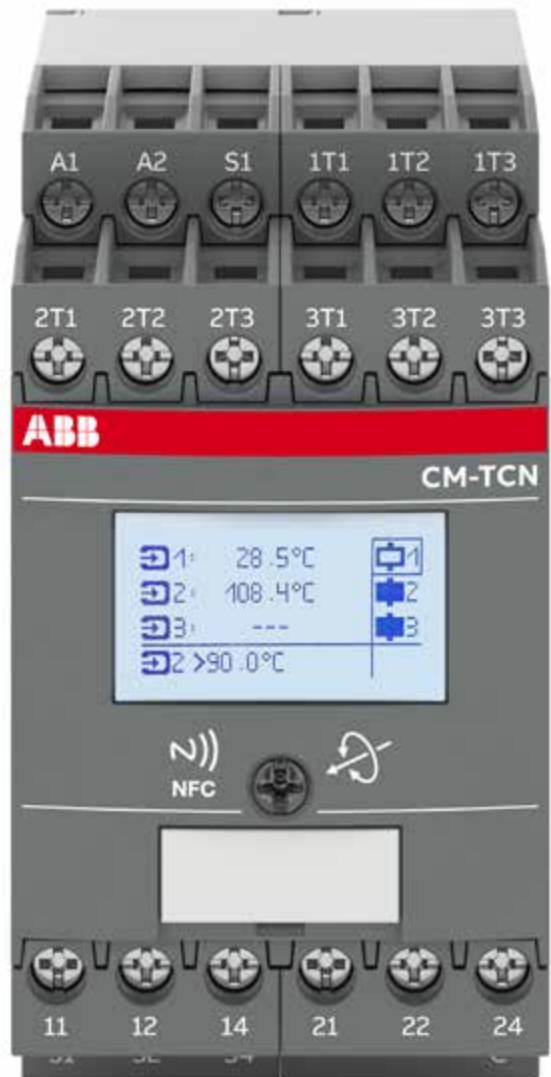

One touch - setup via smartphone app

Powerless configuration with NFC

Configuration and parametrization of temperature monitoring relays has never been simpler. One touch is all that is needed for fast, easy and intuitive configuration with the ABB EPiC mobile phone app.



Near Field Communication (NFC)

NFC is an international transmission standard based on radio-frequency identification technology for the contact-less exchange of data. This technology is already integrated into most electronic devices like tablets and smartphones and part of everyday life, e.g. for contactless payment.



ABB EPiC smartphone app

Electrification Products intuitive Configurator (EPiC) is a mobile application that makes it possible to configure and check the status of ABB low voltage products. The app is available for free - just download it and connect to your smart monitoring relays, circuit breakers and other devices.



Easy visualization

Monitor the status of the relay and read the measured values in the app.



Store and send parameters

Store a set of parameters in the app and distribute them globally and copy them to other devices.



Powerless adjustment

Parametrize and configure the relays even while not connected to a power supply, e.g. on office desks.



One touch setup

Handle the relays with just one touch- just hold the smartphone against the front of the relay.



Copy and paste functionality

Simply copy the settings from one device to another—with just one touch to the relay.



Event history

Examine the history of the device and recent events.

Built-in connectivity

Communication via embedded Modbus RTU

The smart temperature monitoring relay CM-TCN.012 supports the data transfer using the Modbus RTU communication protocol. The communication interface RS-485 is embedded in the relay and does not require installation of any accessories.



CM-TCN manual
Modbus communication map and information about the device configuration can be found in the CM-TCN user manual



The communication interface makes it possible to:



Read the temperature measurements, relays state and temperature sensors status.



Reset the history and settings (trip counter, event history, etc)



Access the condition monitoring data such as event history, operating hours counter, maintenance counter, statistics.



Read system information (serial number, firmware version)



Configure the smart monitoring relay remotely.

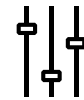

Control output relays and trigger them in case of the communication bus error



Client



Server 1



Server 2



Server N



Cloud integration with ABB Ability™

Real-time data monitoring and temperature trends

Providing full remote visibility of asset and electrical-system behavior, ABB Ability™ Energy and Asset Manager (EAM) provides insights that help you minimize costs, risks and maximize performance as well as safety across your operations.

The CM-TCN.012 smart monitoring relay is enabled in ABB Ability™ Energy and Asset Manager. Thus, allowing access to the real-time data monitoring and temperature trends from the cloud solution.

The data received from CM-TCN.012 is organized in plain widgets for the remote condition monitoring of assets such as a machine, motor, transformer or switchboard. The temperature trends can be compared between different measuring sensors giving you valuable insights about temperature behavior of your assets at the place of the sensors' installation.

Additionally, the customer can set up SMS or E-mail alerts to notify key personnel in case of the temperature relay tripping or sensors error. The periodic report with temperature values can also be scheduled.

CM-TCN.012 can be connected to the cloud-computing platform via Modbus RS-485 communication interface. The interface is embedded in the device and does not require any accessories.

The smart relay can share the data with the platform using an external solution with the ABB Ability™ Edge Industrial Gateway.

ABB Ability™ Energy and Asset Manager

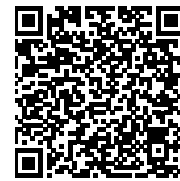

Example communication architecture

CM-TCN.12 ABB Ability™ enabled relay

ABB Ability™ Energy and Asset Manager is a state-of-the-art cloud solution that integrates energy and asset management in a single intuitive dashboard.

Architecture with ABB Ability™ Edge Industrial Gateway

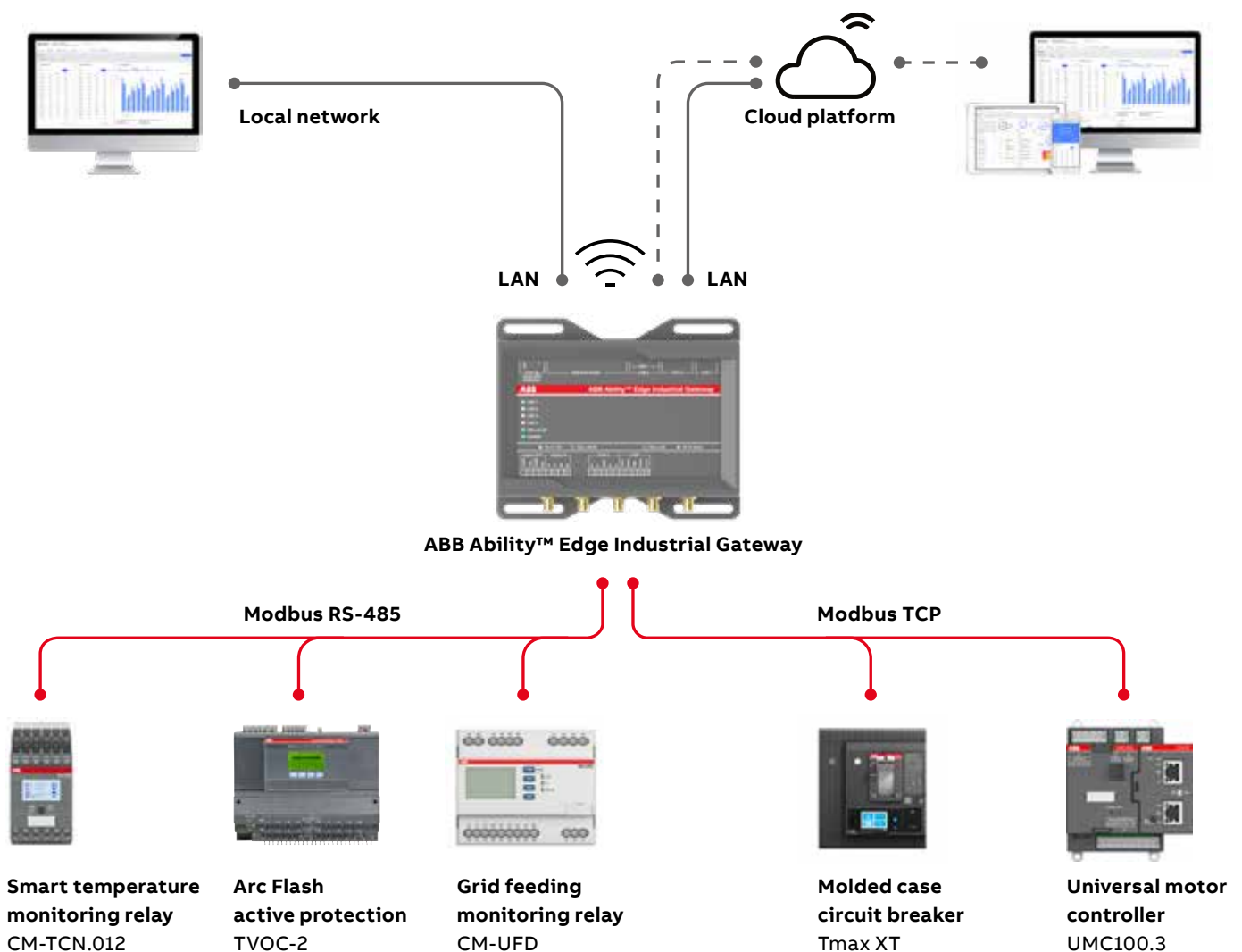

Integrate a range of devices like circuit breakers, motor controllers and the new CM-TCN.012 monitoring relay into the ABB Ability™ Energy and Asset Manager. It is a state-of-the-art cloud solution that integrates energy and

asset management in a single intuitive dashboard. Providing full remote visibility of asset and electrical-system behavior, ABB Ability™ Energy and Asset Manager (EAM) provides insights that help you minimize cost and risk

and maximize performance and safety across your operations.

Applications

Temperature monitoring relays are used in a wide array of applications. In conjunction with temperature sensors, such as PT100 or PTC sensors, they monitor motor temperature, control cabinet temperature and protect transformers from overheating.



Temperature sensor, e.g. PT100



Smart temperature monitoring relay



ABB EPiC smart-phone app



Operating controls



Push-in and screw terminals



3 measuring inputs
PT100, PT1000, PTC, NTC



Marker label



Connection terminals
Wide terminal spacing allows connection of wires:
2 x 1.5 mm² (2 x 16 AWG) with wire end ferrules or
2 x 2.5 mm² (2 x 14 AWG) without ferrules.

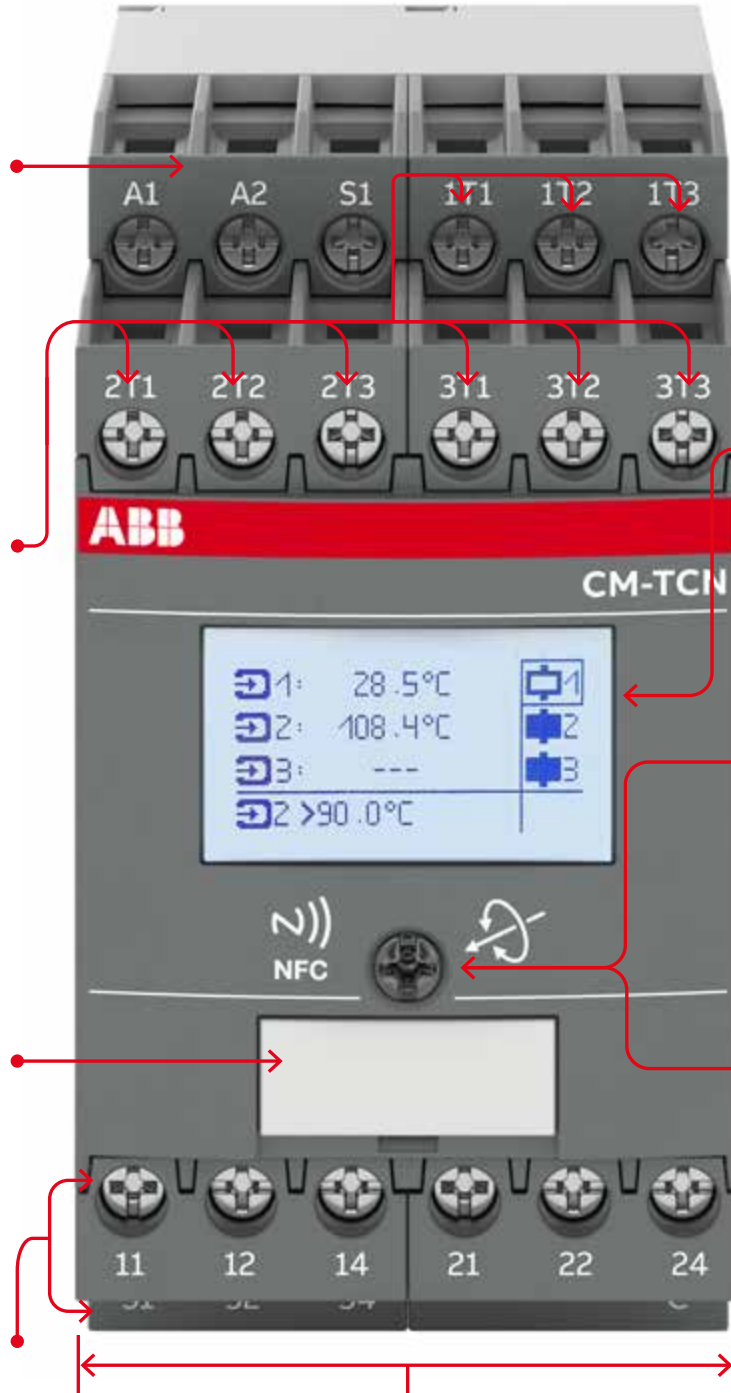

Back-lit LCD
Symbol-based menu structure



Push-rotate button
Intuitive operation with just one button



LED status indication
Red: Failure
Yellow: NFC ready for pairing
Green: Control supply voltage applied; no failure



Width 45 mm

Smart monitoring relays

Selection table

	Type	Order number				
	CM-TCN.011S	1SVR750740R0110				
	CM-TCN.011P	1SVR760740R0110				
	CM-TCN.012S	1SVR760740R0120				
	CM-TCN.012P	1SVR750740R0120				
Rated control supply voltage U_s						
24-240 V AC/DC	■*	■*	■	■		
Sensor circuits (2 or 3 wire)						
Number of temperature sensors	3	3	3	3		
Number of thresholds	9	9	9	9		
Sensor types						
PT100	■	■	■	■		
PT1000	■	■	■	■		
NTC	■	■	■	■		
PTC	■	■	■	■		
Bi-metal switch	■	■	■	■		
Measuring temperature range						
-200...+850 °C	■	■	■	■		
Interface						
Display	■	■	■	■		
NFC	■	■	■	■		
Modbus RTU			■	■		
Monitoring function						
Overtemperature	■	■	■	■		
Undertemperature	■	■	■	■		
Window temperature	■	■	■	■		
Temperature difference	■	■	■	■		
Operating principle						
Open or closed-circuit principle	■	■	■	■		
Output contacts						
c/o	3	3	3	3		

* CM-TCN.011: supply voltage 24-240 V AC/DC for revision G or later and supply voltage 24 V AC/DC for revision F or earlier.

Smart monitoring relays

Ordering details



CM-TCN

Description

The temperature monitoring relays CM-TCN are able to measure temperatures of solids, liquids and gaseous media within up to three sensor circuits using different types of sensors, such as PT100, PT1000, PTC or NTC within the same time. Different types of sensors, e.g. PT100 and PTC sensors, can be monitored simultaneously. The temperature is obtained by the sensors in the medium, evaluated by the device and monitored to determine whether it is within an operating range (range monitoring function) or has exceeded or fallen below a threshold. Depending on the parametrization, up to three output relays signalize the changes in the measuring circuits.

Smart temperature monitoring relays CM-TCN

Rated control supply voltage	Terminal type	Display & NFC	Modbus RTU	Temperature sensor	Width	Type	Order code	Weight (1 pc)
					mm			kg (lb)
24-240 V AC/DC*	Screw	yes	no	PT100, PTC, PT1000, NTC	45	CM-TCN.011S	1SVR750740R0110	0.293 (0.646)
	Push-in	yes	no			CM-TCN.011P	1SVR760740R0110	0.293 (0.646)
	Screw	yes	yes			CM-TCN.012S	1SVR750740R0120	0.299 (0.659)
	Push-in	yes	yes			CM-TCN.012P	1SVR760740R0120	0.299 (0.659)

* CM-TCN.011: supply voltage 24-240 V AC/DC for revision G or later and supply voltage 24 V AC/DC for revision F or earlier.

Accessories

Description	for type	Width	Type	Order code	Pkg qty	Weight (1 pc)
		mm				kg (lb)
Adapter for screw mounting	CM-N.S/P	45	ADP.02	1SVR440029R0100	1	36.7 (1.30)
Marker label	CM-S.S/P CM-N.S/P		MAR.01	1SVR366017R0100	10	0.19 (0.007)
Sealable transparent cover	CM-N.S/P	45	COV.12	1SVR750005R0100	1	7 (0.247)

Smart monitoring relays

Technical data





Data at Ta = 25 °C and rated values, unless otherwise indicated

Type		CM-TCN.011	CM-TCN.012
Input circuit		A1-A2	
Rated control supply voltage U _s		24-240 V AC/DC*	
Rated control supply voltage U _s tolerance		-15 ... +10 %	
Rated frequency	AC	50 - 60 Hz	
Frequency range	AC	45 - 66 Hz	
Typical current consumption	24 V AC/DC	typ. 30 mA / max. 40 mA	
	115 V AC	typ. 16 mA / max. 20 mA	
	230 V AC	typ. 13 mA / max. 15 mA	
Power failure buffering time		min. 20 ms	
Measuring circuits		xT1, xT2, xT3	
Sensor type		PT100, PT1000, PTC, NTC, bi-metal switch	
Connection of the sensor	2-wire	yes, jumper xT2 - xT3	
	3-wire	yes, use terminal xT1, xT2, xT3	
Interrupted wire detection		yes	
Short-circuit detection		yes	
Measuring ranges	PT100	-200 °C ... +850 °C / -328 °F ... +1562 °F	
	PT1000	-200 °C ... +850 °C / -328 °F ... +1562 °F	
	NTC	+80 °C ... +155 °C / +176 °F ... +311 °F	
	PTC	max. total resistance of connected resistors in cold state <750 Ohm	
Monitoring functions		undertemperature, overtemperature, window monitoring	
Measuring input range		-200 ... +850 °C / -328 ... +1562 °F	
Hysteresis related to the threshold values		1 ... 99.9 °C / 1.8 ... 179.8 °F	
Measuring principle		continuous current	
Typical current in the sensor circuit	PT100	0.5 mA	
	PT1000	0.5 mA	
Maximum current in sensor circuit		0.5 mA	
Measuring accuracy		± 0.5 K (-50 ... +200 °C / -58 ... +392 °F) ± 1 K (< -50 °C / -58 °F and > 200 °C / 392 °F)	
Accuracy within the rated control supply voltage tolerance		< 0.05 % full scale/1 V	
Accuracy within the temperature range		< 0.05 % full scale/1 K	
Repeat accuracy (constant parameters)		± 0.07 % full scale	
Maximum measuring cycle		< 2 s	
Maximum cable length		500 m / 1 mm ² (shielded cable)	
Control circuits			
Type of triggering		volt-free triggering	
Control function	S1	remote reset	
Maximum input current		< 1.5 mA	
Maximum no-load voltage at the control inputs		< 15 V	
Minimum control pulse length		150 ms	
Maximum cable length at the control inputs		100 m - 100 pF/m	

* CM-TCN.011: supply voltage 24-240 V AC/DC for revision G or later and supply voltage 24 V AC/DC for revision F or earlier.

Smart monitoring relays

Technical data

Type	CM-TCN.011	CM-TCN.012
Timing functions		
Power-on delay	2-999.9 s	
ON-delay R1, R2, R3 *	0-6553.5 s	
OFF-delay R1, R2, R3 *	0-6553.5 s	
Cyclic switching function	On time	1 min - 1 day
	cycle time	10 min - 1 year
Indication of operational states		
Control supply voltage applied	LED green	
Cyclic switching function running	LED orange	
Internal fault	LED red on	
Short circuit	LED red: 	
Wire break	LED red: 	
Overtemperature / Measurement value exceeds high limit	LED red: 	
Undertemperature / Measurement value exceeds low limit	LED red: 	
Parameter error	Orange and red LEDs alternate	
NFC pairing	LED orange: 	
For details see the message on the display		
Display		
Technology	LCD	
Backlight	on	press button
	off	switch-off delay adjustable, 10 s -1 h (default 10 s)
Resolution	128 x 64 pixel	
Display size	28 x 16 mm	
Operating controls		
Push-rotate button	Operable with screw driver: PZ1 DIN ISO 8764-1	
Near field communication (NFC)		
Standards	ISO/IEC 14443 Part 2+3 NFC Forum Type 2 tag compliant	
Communication interface		
Communication protocol	-	Modbus RTU
Physical interface	-	two-wire RS-485
Integrated termination resistors	-	no
Possible bus addresses	-	1 ... 247
Baud rates	-	1200, 2400, 4800, 9600, 19200, 38400, 57600, 115200 B/s
Typical response time	-	< 30 ms
Bus master supervision time / Timeout	-	adjustable 1 ... 255 s in steps of 1 s
Frame	-	8 data, Even, 1 stop 8 data, Odd, 1 stop 8 data, None, 2 stop 8 data, None, 1 stop

* If the selected ON-delay or OFF-delay is less than 2 s, the maximum measuring cycle should be taken into account.

Smart monitoring relays

Technical data

Type		CM-TCN.011	CM-TCN.012
Output circuits			
Kind of outputs	11-12/14	relay R1, c/o (SPDT) contact	
	21-22/24	relay R2, c/o (SPDT) contact	
	31-32/34	relay R3, c/o (SPDT) contact	
Operating principle	open- or closed circuit principle	configurable; default: closed-circuit principle*	
Contact material		AgNi alloy, Cd-free	
Maximum switching voltage / maximum switching current		see "Load limit curves"	
Rated operational voltage U_e and rated operational current I_e	AC-12 (resistive) at 230 V	4 A	
	AC-15 (inductive) at 230 V	3 A	
	DC-12 (resistive) at 24 V	4 A	
	DC-13 (inductive) at 24 V	2 A	
Mechanical lifetime		30 x 10 ⁶ switching cycles	
Electrical lifetime	at AC-12, 230 V AC, 4 A	0.1 x 10 ⁶ switching cycles	
Maximum fuse rating to achieve short-circuit protection	n/c contact	6 A fast-acting	
	n/o contact	10 A fast-acting	
Conventional thermal current I_{th}		4 A	
General data			
MTBF		on request	
Duty cycle		100 %	
Dimensions		see "Dimensional drawing"	
Mounting		DIN rail (IEC/EN 60715) TH 35-7.5 and TH 35-15, snap-on mounting without any tool	
Mounting position		any	
Minimum distance to other units	horizontal	not necessary	
Material of housing		UL 94 V-0	
Degree of protection	housing / terminals	IP50/IP20	
Electrical connection		CM-TCN.011S, CM-TCN.012S	CM-TCN.011P, CM-TCN.012P
Connecting capacity	fine-strand with/ without wire end ferrule	A1, A2, R1, R2, R3, S1, C	2x0.5-1.5 mm ² (2x18-16 AWG)
		xT1, xT2, xT3, A, B, C	2x0.2-1.5 mm ² (2x24-16 AWG)
	rigid	A1, A2, R1, R2, R3, S1, C	2x0.5-1.5 mm ² (2x20-16 AWG)
		xT1, xT2, xT3, A, B, C	2x0.2-1.5 mm ² (2x24-16 AWG)
Stripping length		8 mm (0.32 in)	
Tightening torque	< 0.5 mm ²	0.5 Nm (4.43 lb.in)	
	≥ 0.5 mm ²	0.6 - 0.8 Nm (7.08 lb.in)	

* Closed-circuit principle: Output relay de-energizes if a fault is occurring

Open-circuit principle: Output relay energizes if a fault is occurring

Smart monitoring relays

Technical data

Type	CM-TCN.011	CM-TCN.012
Environmental data		
Ambient temperature ranges	operation	-25 °C...+60 °C (-13...+140 °F)
	storage	-40 °C...+85 °C (-40...+185 °F)
Damp heat, cyclic	IEC/EN 60068-2-30	6 x 24 h cycle, 55 °C, 95 % RH
Climatic class	IEC/EN 60721-3-3	3K5 (no condensation, no ice formation)
Vibration, sinusoidal		class 1
Shock		class 1
Isolation data		
Rated impulse withstand voltage (U_{imp}) EN/IEC60664-1	supply circuit / measuring circuit and modbus / output circuits (relay)	6 kV
	output circuit 1 / output circuit 2 / output circuit 3	4 kV
Rated insulation voltage U_i Basic insulation	supply circuit / measuring circuit and modbus / output circuits (relay)	600 V
	output circuit 1 / output circuit 2 / output circuit 3	300 V
Protective separation IEC/EN 61140	supply circuit / measuring circuit and modbus / output circuits (relay)	300 V
	output circuit 1 / output circuit 2 / output circuit 3	150 V
Pollution degree		3
Overvoltage category		III
Standards/Directives		
Standards		IEC/EN 60947-5-1
Low Voltage Directive		2014/35/EU
EMC Directive		2014/30/EU
RoHS Directive		2011/65/EU incl. 2015/863/EU
WEEE Directive		2012/19/EU
RED Directive		2014/53/EU
Electromagnetic compatibility		
Interference immunity to		IEC/EN 60947-5-1
electrostatic discharge	IEC/EN 61000-4-2	level 2, 4 kV contact discharge, 8 kV air discharge
radiated, radio-frequency, electromagnetic field	IEC/EN 61000-4-3	level 3, 10 V/m; 2.7 GHz
electrical fast transient / burst	IEC/EN 61000-4-4	level 3 / 2 kV, 5 kHz
surge	IEC/EN 61000-4-5	supply circuit: level 3; L-L 1 kV, L-PE 2 kV relay circuit: level 3; L-PE 2 kV measuring circuit, remote S1: level 2; L-PE 1 kV
conducted disturbances, induced by radio-frequency fields	IEC/EN 61000-4-6	level 3, 10 V
voltage dips, short interruptions and voltage variations	IEC/EN 61000-4-11	class 3
Interference emission		IEC/EN 60947-5-1
high-frequency radiated		fulfilled (environment B)
high-frequency conducted		fulfilled (environment A)

Smart monitoring relays

Technical diagrams

Dimensional drawings in mm and inches

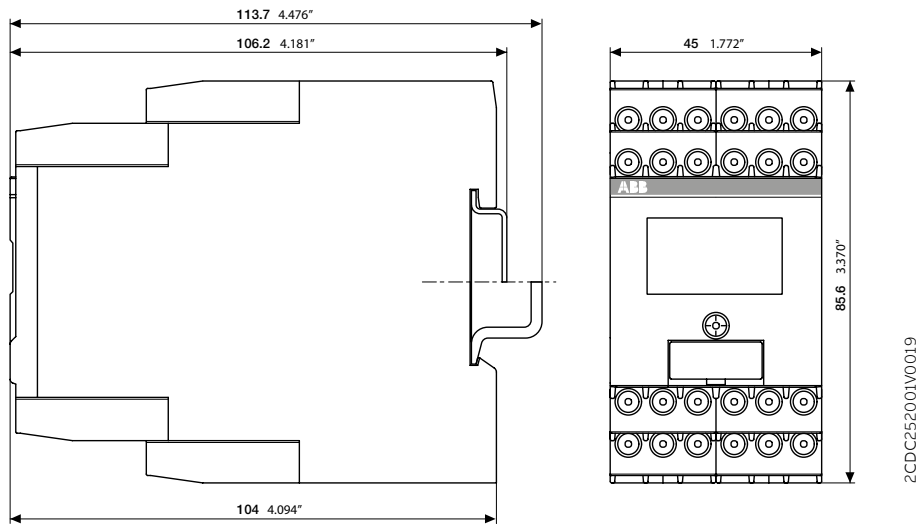

CM-TCN.011

Load limit curves

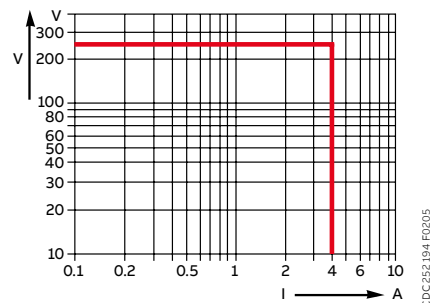

AC load (resistive)

2CDC252.194 F0205

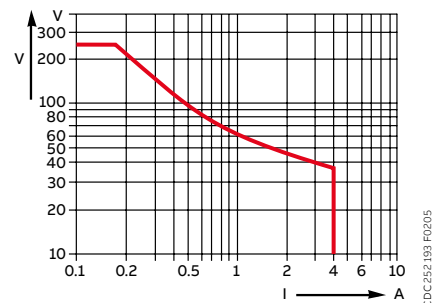

DC load (resistive)

2CDC252.193 F0205

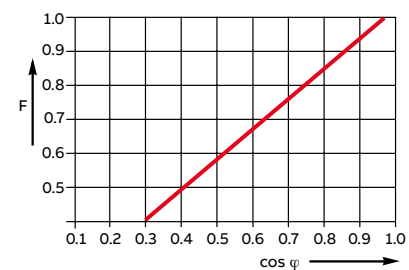

Derating factor F for inductive AC load

2CDC252.198 F0205

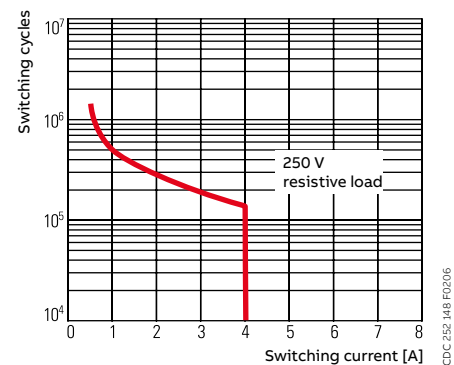

Contact lifetime

2CDC252.148 F0206



Liquid level monitoring relays

Table of contents

240	Benefits and advantages
242	Applications
246	Operating controls
248	Selection table
249	Ordering details
250	Technical data
256	Function diagrams
257	Technical diagrams

Liquid level monitoring relays

Benefits and advantages



ABB's liquid level monitoring relays are the ideal solution to regulate and control liquid levels and ratios of mixtures of conductive fluids. The assortment includes single- or multifunctional devices which can be used for overflow protection, dry-running protection of pumps, filling and draining applications as well as max. and min. level alarming.



Global availability

The liquid level monitoring relays are designed to provide a wide supply voltage range, making global differences irrelevant. Additionally, the CM-ENS range meets a broad range of standards and requirements. Together with ABB's global support and sales network, using CM-ENS gives customers the confidence of worldwide sourcing – no matter where they build, install or operate their equipment.



Reliable in harsh conditions

High immunity against electromagnetic disturbances is ensured due to advanced measuring technology. Additionally, the housing fulfills the UL 94 V-0 flammability standard requirements. Together with the vibration resistant push-in terminals, the relay is not only reliable no matter the environment temperature but is also durable to shock and vibration. Save time as re-tightening is no longer needed and enhance the reliability and safety not only for the equipment.



Improve installation efficiency

Like all devices from the measuring and monitoring portfolio, the CM-ENS relays are easily configurable via front facing potentiometers. Easy threshold configuration without calculation is accomplished by direct reading scales. The device can be set up before installation in the application and easy adjustments during the process are possible.

Liquid level monitoring relays

Benefits and advantages



Operating principle

Liquid level control relays CM-ENS are designed to monitor levels of conductive liquids and media and is used, for example, for liquid level control in pump systems. The measuring principle is based on the resistance change sensed by single-pole electrodes. To avoid electrolytic phenomena, an AC current runs across the probes.

A selector switch on the front panel allows selection of the required function and the sensitivity range.



Suitability

Suitable for		Not suitable for	
spring water	acids, bases	chemically pure water	ethylene glycol
drinking water	liquid fertilizers	fuel	concentrated alcohol
sea water	milk, beer, coffee	oils	paraffin
sewage	non-concentrated alcohol	explosive areas (liquid gas)	lacquers



Characteristics

CM-ENS.1x

- Control of one or two liquid levels (min/max)
- Fill or drain function
- Adjustable response sensitivity 5-100 kΩ

CM-ENS.2x

- Control of one or two liquid levels (min/max)
- Fill (UP) or Drain (DOWN), adjustable via front-face potentiometer
- Adjustable response sensitivity 0.1-1000 kΩ

CM-ENS.31

- Control of one or two liquid levels (min/max)
- Fill (UP) or Drain (DOWN), adjustable via front-face potentiometer
- Adjustable response sensitivity 0.1-1000 kΩ
- Selectable ON- or OFF-delay
- 2 c/o (SPDT) contacts

All CM-ENS devices

- Devices with wide rated control supply voltage 24-240 V AC/DC
- Cascadable
- High EMC immunity
- 3 LEDs for the indication of operational states
- Screw connection technology or Easy Connect Technology
- Housing material for highest fire protection classification UL 94 V-0
- Tool-free mounting and demounting on DIN rail
- 22.5 mm (0.89 in) width

Liquid level monitoring relays

Applications

Liquid level monitoring relays work in conjunction with, for example, suspension electrodes, and can be used either for direct liquid level control or also for cascading devices, as well as operation modes with several electrodes, or control of two liquid levels are possible.



Suspension
electrode



Liquid level monitoring relays

Applications

Cascading of several devices

With the CM-ENS it is possible to use two devices in one tank. This enables the possibility to realize a pre-warning with additional electrodes. In this way, two additional alarm outputs for exceeding or dropping below the normal level can be implemented in addition to the filling levels MAX and MIN. In addition, a reserve pump can be connected to the additional device.

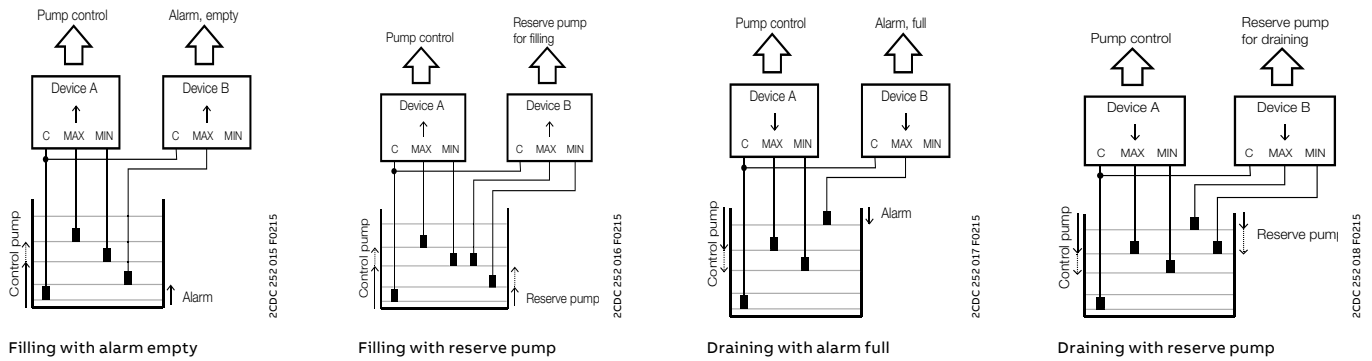

Operating mode with three electrodes

The CM-ENS measures the electrical resistance of the liquid between two immersion electrodes and a reference electrode.

For CM-ENS.1x only: If the relay is connected to the rated control supply voltage, the output relay changes its switching state as soon as the liquid level reaches the MAX-electrode, while the minimum sensor is submerged. The relay returns to the original state as soon as the minimum sensor is no longer in contact with the monitored medium.

For CM-ENS.2x and CM-ENS.31 only: The function fill (Λ) or drain (∇) can be selected via a front-face potentiometer. If the fill function is selected, the output relay is energized until the MAX-electrode becomes wet. Then it is de-energized and not re-energized until the MIN-electrode becomes dry. If the drain function is selected, the output relay energizes as soon as the MAX-electrode becomes wet. It remains energized until the liquid level has dropped below the MIN-electrode.

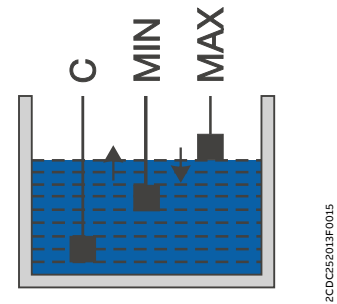

Operation mode with three electrodes

Operation mode with two electrodes

If only one level should be controlled, only the MAX-electrode shall be connected at the CM-ENS.

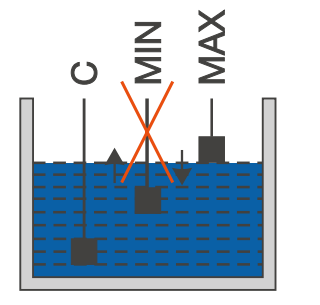

Operation mode with two electrodes

Liquid level monitoring relays

Applications

Control of two liquid levels via liquid level monitoring relay CM-ENS

In combination with suspension electrodes CM-HC or CM-HCT (suitable for drinking water).

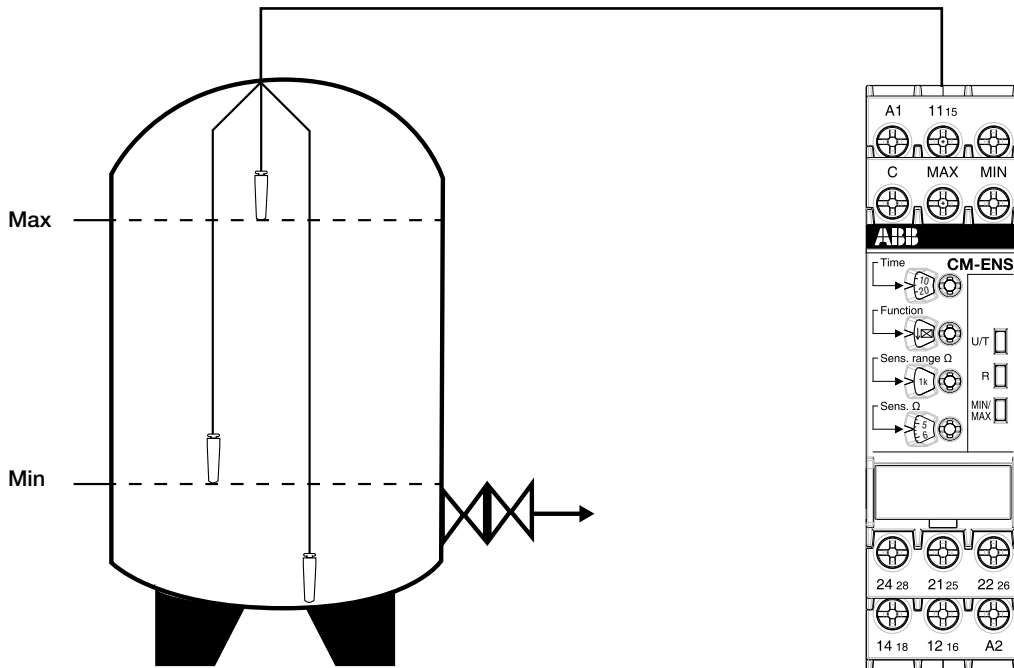

Liquid level monitoring relays

Applications

Liquid overflow monitoring in the twin pump system using liquid level monitoring relay CM-ENS and alternating time relay CT-PAC.

In combination with the compact support CM-KH-3 and 3 bar electrodes CM-SE.

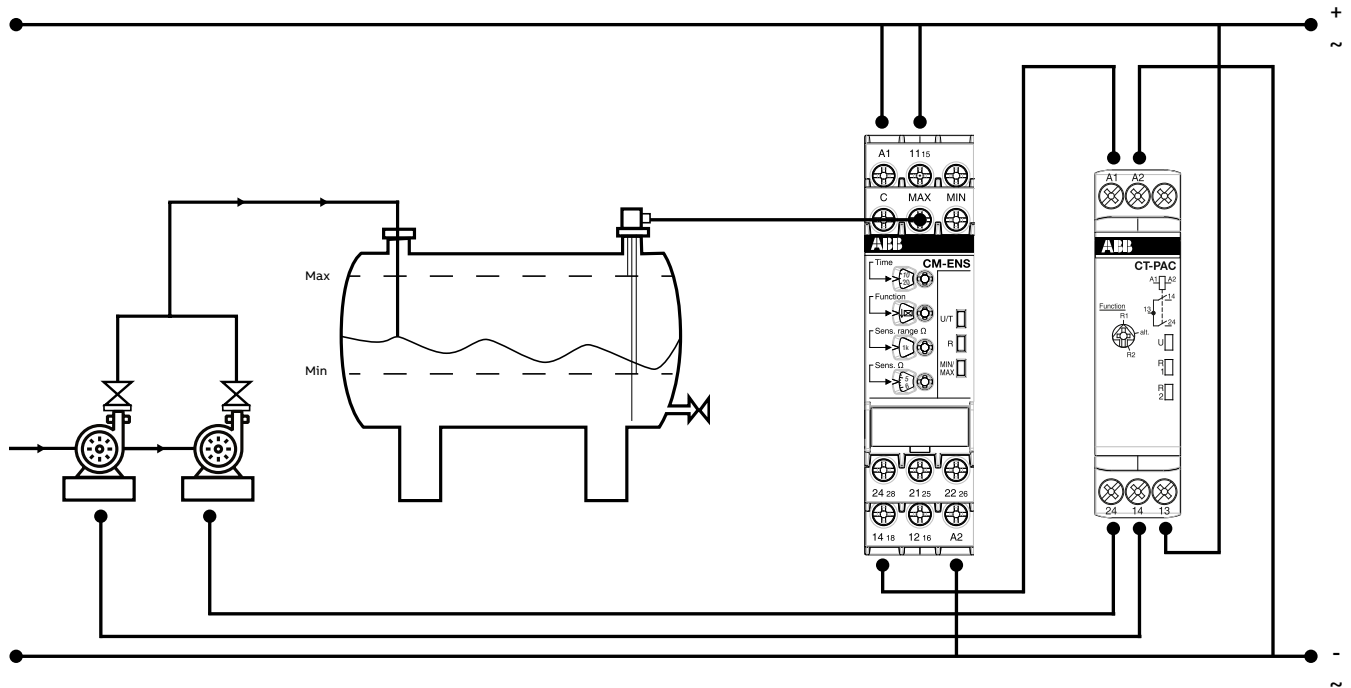

Liquid level monitoring relays

Operating controls

CM-ENS.1x

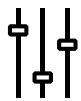

Adjustment of the response sensitivity



Marker label

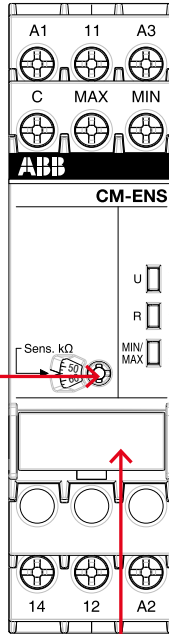

Indication of operational states with LEDs

- U: green LED - Status indication of control supply voltage
- control supply voltage applied
- R: yellow LED - Status indication of the output relays
- energized
- MIN/MAX: yellow LED - Status indication of the electrodes
- MIN and MAX wet
- MIN wet

CM-ENS.2x

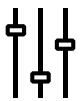

Adjustment of the function

- ↑ Fill
- ↓ Drain

Adjustment of the response sensitivity range

Adjustment of the response sensitivity



Marker label

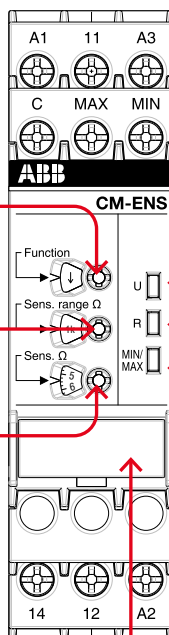

Indication of operational states with LEDs

- U: green LED - Status indication of control supply voltage
- control supply voltage applied
- R: yellow LED - Status indication of the output relays
- energized
- MIN/MAX: yellow LED - Status indication of the electrodes
- MIN and MAX wet
- MIN wet

Liquid level monitoring relays

Operating controls

CM-ENS.31

Adjustment of the time delay



Adjustment of the function

- ↑ ☒ ON-delayed Fill
- ↓ ☒ ON-delayed Drain
- ↑ ■ OFF-delayed Fill
- ↓ ■ OFF-delayed Drain

Adjustment of the response sensitivity range

Adjustment of the response sensitivity



Marker label

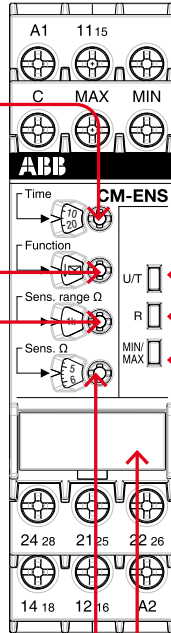

Indication of operational states with LEDs

- U: green LED - Status indication of control supply voltage
- ☐ control supply voltage applied
- ▭ time delay is running
- R: yellow LED - Status indication of the output relays
- ☐ energized
- MIN/MAX: yellow LED - Status indication of the electrodes
- ☐ MIN and MAX wet
- ▭ MIN wet

Liquid level monitoring relays

Selection table

	Type	Order code	1	2	3	4	5	6	7	8	9	10	11	12	13	14	15	16	
	CM-ENE MIN	1SVR 550 855 R9500																	
	CM-ENE MIN	1SVR 550 850 R9500	■																
	CM-ENE MIN	1SVR 550 851 R9500		■															
	CM-ENE MAX	1SVR 550 855 R9400			■														
	CM-ENE MAX	1SVR 550 850 R9400				■													
	CM-ENE MAX	1SVR 550 851 R9400					■												
	CM-ENS.11S	1SVR 730 850 R0100						■	■										
	CM-ENS.11P	1SVR 740 850 R0100								■	■								
	CM-ENS.13S	1SVR 730 850 R2100									■	■							
	CM-ENS.13P	1SVR 740 850 R2100										■	■						
	CM-ENS.21S	1SVR 730 850 R0200											■	■					
	CM-ENS.21P	1SVR 740 850 R0200												■	■				
	CM-ENS.23S	1SVR 730 850 R2200													■	■			
	CM-ENS.23P	1SVR 740 850 R2200														■	■		
	CM-ENS.31S	1SVR 730 850 R0300															■	■	
	CM-ENS.31P	1SVR 740 850 R0300																■	■
Rated control supply voltage Us																			
24-240 V AC/DC										■	■							■	■
24 V AC			■																
110-130 V AC				■								■	■					■	■
220-240 V AC					■							■	■					■	■
Sensor circuit																			
Number of electrodes (including ground reference)			2	2	2	2	2	2	3	3	3	3	3	3	3	3	3	3	3
Response sensitivity range																			
0-100 kΩ			■	■	■	■	■	■											
5-100 kΩ									adj	adj	adj	adj							
0.1-1000 kΩ													adj	adj	adj	adj	adj	adj	adj
Monitoring function																			
Dry running protection			■	■	■				■	■	■	■	■	■	■	■	■	■	■
Overflow protection						■	■	■	■	■	■	■	■	■	■	■	■	■	■
Liquid level control					■	■	■	■	■	■	■	■	■	■	■	■	■	■	■
Operating principle																			
Open-circuit principle			■	■	■				■	■	■	■							
Closed-circuit principle						■	■	■											
Open- or closed-circuit principle													sel	sel	sel	sel	sel	sel	
Adjustable ON-/OFF-delay																			
0.1-10 s																		■	■
Output contacts																			
n/o			1	1	1	1	1	1											
c/o (SPDT)									1	1	1	1	1	1	1	1	1	2	2
Connection type																			
Push-in terminals										■		■		■		■		■	
Double-chamber cage connection terminals								■			■		■		■		■		
Screw			■	■	■	■	■	■											

adj: adjustable
sel: selectable

Liquid level monitoring relays

Ordering details



1SVR550851R9500

CM-ENE MIN



2DCD251004V0015

CM-ENS.3x



1SVR508180R0100

CT-PAC.22

Description

The liquid level monitoring relays CM-ENS and CM-ENE monitors and controls the liquid level and ratios of mixtures of conductive fluids. It is used for filling and draining applications, to protect pumps against dry-running, to protect tanks against overflow, and for signalization of the status of the monitored liquid level.

Ordering details

Characteristics	Type	Order code	Weight (1 pc) kg (lb)
See selection table	CM-ENE MIN	1SVR550855R9500	0.15 (0.33)
		1SVR550850R9500	0.15 (0.33)
		1SVR550851R9500	0.15 (0.33)
	CM-ENE MAX	1SVR550855R9400	0.15 (0.33)
		1SVR550850R9400	0.15 (0.33)
		1SVR550851R9400	0.15 (0.33)
	CM-ENS.11S	1SVR730850R0100	0.124 (0.273)
	CM-ENS.11P	1SVR730850R2100	0.117 (0.258)
	CM-ENS.13S	1SVR740850R0100	0.153 (0.337)
	CM-ENS.13P	1SVR740850R2100	0.145 (0.320)
	CM-ENS.21S	1SVR730850R0200	0.125 (0.276)
	CM-ENS.21P	1SVR740850R0200	0.117 (0.258)
	CM-ENS.23S	1SVR730850R2200	0.154 (0.340)
	CM-ENS.23P	1SVR740850R2200	0.147 (0.324)
	CM-ENS.31S	1SVR730850R0300	0.143 (0.315)
CM-ENS.31P	1SVR740850R0300	0.134 (0.295)	

Description

The alternating relay CT-PAC is designed to evenly use the electromechanical resource of a twin pump, dual compressors and generators. The alternating relay has two normally open contacts, which are closed alternately each time the control supply voltage is applied to terminals A1-A2.

A front-face rotary switch allows to select among three functions:

- R1 – each power cycle contact 13-14 closes
- R2 – each power cycle contact 13-24 closes
- alt. (default) – output contacts close alternately each power cycle

Ordering details

Rated control supply voltage	Type	Order code	Weight (1 pc) kg (lb)
24-240 V AC/ 24-48 V DC	CT-PAC.22	1SVR508180R0100	0.059 (0.130)

The technical data can be found in the time relays chapter.

Liquid level monitoring relays

Technical data

Type		CM-ENE MIN	CM-ENE MAX
Supply circuit			
Rated control supply voltage U_s - power consumption	A1-A2	24 V AC, approx. 1.5 VA	
	A1-A2	110-130 V AC, approx. 1.2 VA	
	A1-A2	220-240 V AC, approx. 1.4 VA	
Rated control supply voltage U_s tolerance		-15...+15 %	
Rated frequency		50-60 Hz	
Measuring circuit		MIN-C, MAX-C	
Monitoring function		dry-running protection	overflow protection
Response sensitivity		0-100 k Ω , not adjustable	
Maximum electrode voltage		30 V AC	
Maximum electrode current		1.5 mA	
Electrode supply line	max. cable capacity	3 nF	
	max. cable length	30 m	
Timing circuit			
Tripping delay		fixed approx. 200 ms	
Indication of operational states			
Output relay energized		R: yellow LED	
Output circuits		13-14	
Kind of output		1 n/o contact	
Operational principle ¹⁾		open-circuit principle ¹⁾	closed-circuit principle ¹⁾
Rated operational voltage U_e (IEC/EN 60947-1)		250 V	
Minimum switching voltage / minimum switching current		- / -	
Maximum switching voltage		250 V	
Rated operational voltage U_e and rated operational current I_e	AC-12 (resistive) 230 V	4 A	
	AC-15 (inductive) 230 V	3 A	
	DC-12 (resistive) 24 V	4 A	
	DC-13 (inductive) 24 V	2 A	
AC rating (UL 508)	Utilization category (Control Circuit Rating Code)	B 300	
	max. rated operational voltage	300 V AC	
	max. continuous thermal current at B 300	5 A	
	max. making/breaking apparent power at B 300	3600/360 VA	
Mechanical lifetime		30 x 10 ⁶ switching cycles	
Electrical lifetime (AC-12, 230 V, 4 A)		0.3 x 10 ⁶ switching cycles	
Max. fuse rating to achieve short-circuit protection	n/c contact	-	
	n/o contact	10 A fast-acting	
General data			
Duty cycle		100 %	
Dimensions		see dimensional drawings	
Mounting		DIN rail (IEC/EN 60715)	
Mounting position		any	
Degree of protection	enclosure / terminals	IP50 / IP20	
Ambient temperature range	operation / storage	-20...+60 °C / -40...+85 °C	
Electrical connection			
Wire size	fine-strand with wire-end ferrule	2 x 0.75-1.5 mm ² (2 x 18-16 AWG)	
	fine-strand without wire-end ferrule	2 x 1-1.5 mm ² (2 x 18-16 AWG)	
	rigid	2 x 0.75-1.5 mm ² (2 x 18-16 AWG)	
Stripping length		10 mm (0.39 inch)	
Tightening torque		0.6-0.8 Nm	

Liquid level monitoring relays

Technical data

Type	CM-ENE MIN	CM-ENE MAX
Standards / Directives		
Standard	IEC/EN 60947-5-1	
Low Voltage Directive	2014/35/EU	
EMC Directive	2014/35/EU	
RoHS Directive	2011/65/EU	
Electromagnetic compatibility		
Interference immunity to	EN 61000-6-2, EN 61000-6-4	
Electrostatic discharge	IEC/EN 61000-4-2	level 3 (6 kV / 8 kV)
Radiated, radio-frequency, electromagnetic field	IEC/EN 61000-4-3	level 3 (10 V/m)
Electrical fast transient / burst	IEC/EN 61000-4-4	level 3 (2 kV / 5 kHz)
Surge	IEC/EN 61000-4-5	level 4 (2 kV L-L)
Conducted disturbances, induced by radio-frequency fields	IEC/EN 61000-4-6	level 3 (10 V)
Interference emission		
high-frequency radiated	IEC/CISPR 22, EN 55022	class B
high-frequency conducted	IEC/CISPR 22, EN 55022	class B
Environmental data		
Ambient temperature ranges	operation/storage	-20...+60 °C / -40...+85 °C
Damp heat	IEC/EN 60068-2-30	40 °C, 93 % RH, 4 days
Vibration withstand	IEC/EN 60068-2-6	10-57 Hz: 0.075 mm; 57-150 Hz: 1 g
Isolation data		
Rat. insulation volt. betw. supply, measuring & output circuit	250 V	
Rated impulse withstand voltage U_{imp} between all isolated circuits	4 kV / 1.2-50 μ s	
Pollution category	3	
Overvoltage category	III	

1) Open-circuit principle: Output relay energizes if the measured value exceeds/drops below the adjusted threshold.

Closed-circuit principle: Output relay de-energizes if the measured value exceeds/drops below the adjusted threshold.

Liquid level monitoring relays

Technical data

Type	CM-ENS.1x	CM-ENS.2x	CM-ENS.31				
Supply circuit							
Rated control supply voltage U_s	CM-ENS.11, CM-ENS.21, CM-ENS.31: A1-A2	24-240 V AC/DC					
	CM-ENS.13, CM-ENS.23: A1-A2	220-240 V AC					
	CM-ENS.13, CM-ENS.23: A3-A2	110-130 V AC					
Rated control supply voltage U_s tolerance	-15...+10 %						
Rated frequency	50-60 Hz						
Frequency range	47-63 Hz						
Typical current / power consumption	24 V AC	25 mA / 0.6 W	25 mA / 0.6 W				
	110-130 V AC	20 mA / 2.6 VA	20 mA / 2.6 VA				
	220-240 V AC	8.5 mA / 2.1 VA	8.5 mA / 2.1 VA				
	24-240 V AC/DC	11 mA / 2.6 VA	11 mA / 2.6 VA				
Power failure buffering time	min.	20 ms					
Start-up time t_s	Range 5-100 k Ω	max. 1.3 s	-				
	Range 0.1-1 k Ω	-	max. 900 ms				
	Range 1-10 k Ω	-	max. 900 ms				
	Range 10-100 k Ω	-	max. 1.3 s				
	Range 100-1000 k Ω	-	max. 6.3 s				
Measuring circuit							
MAX-MIN-C							
Sensor type	electrode						
Monitoring function	fill or drain	fill or drain, selectable					
Measuring principle	conductivity measurement						
Number of electrodes	3						
Response sensitivity	adjustable: 5-100 k Ω	adjustable: 0.1-1000 k Ω					
Maximum electrode voltage	6 V AC						
Maximum electrode current	1 mA		2 mA				
	max cable capacity	max cable length	max cable capacity				
Electrode supply line	Range 5-100 k Ω	10 nF	100 m	-	-	-	-
	Range 0.1-1 k Ω	-	-	200 nF	1000 m	200 nF	1000 m
	Range 1-10 k Ω	-	-	200 nF	1000 m	200 nF	1000 m
	Range 10-100 k Ω	-	-	20 nF	100 m	20 nF	100 m
	Range 100-1000 k Ω	-	-	4 nF	20 m	4 nF	20 m
Max. measuring cycle	Range 5-100 k Ω	1000 ms		-		-	
	Range 0.1-1 k Ω	-		700 ms		-	
	Range 1-10 k Ω	-		700 ms		-	
	Range 10-100 k Ω	-		1.1 s		-	
Range 100-1000 k Ω	-		5 s		-		
Timing circuit							
Time delay	-		0.1-30 s, adjustable, ON- or OFF-delay				
Indication of operational states							
Control supply voltage	U: green LED						
Output relay energized	R: Yellow LED						
Electrode / alarm status	MAX/MIN: Yellow LED						

Liquid level monitoring relays

Technical data

Type	CM-ENS.1x	CM-ENS.2x	CM-ENS.31
Output circuits			
Kind of output	11 ₁₅ -12 ₁₆ /14 ₁₈	relay, 1 c/o (SPDT) contact	relay, 1st c/o (SPDT) contact
	21 ₁₅ -22 ₁₆ /24 ₁₈	-	relay, 2nd c/o (SPDT) contact
Operational principle	open-circuit principle	open- or closed-circuit principle (selectable)	
Contact material	AgNi alloy, Cd free		
Minimum switching voltage / minimum switching current	12 V / 10 mA		
Maximum switching voltage / Maximum switching current	see data sheets		
Rated operational voltage U _e and rated operational current I _e (IEC/EN 60947-5-1)	AC-12 (resistive) 230 V	4 A	
	AC-15 (inductive) 230 V	3 A	
	DC-12 (resistive) 24 V	4 A	
	DC-13 (inductive) 24 V	2 A	
AC rating (UL 508)	Utilization category (Control Circuit Rating Code)	B 300, pilot duty general purpose 250 V, 4 A, cos φ 0.75	
	max. rated operational voltage	300 V AC	
	max. continuous thermal current at B 300	5 A	
	max. making/breaking apparent power at B 300	3600/360 VA	
Mechanical lifetime	10 x 10 ⁶ switching cycles		
Electrical lifetime (AC-12, 230 V, 4 A)	0.1 x 10 ⁶ switching cycles		
Max. fuse rating to achieve short-circuit protection	n/c / n/o contact	6 A / 10 A fast-acting	10 A / 10 A fast-acting
Conventional thermal current I _{th}	4 A		

Liquid level monitoring relays

Technical data

Type		CM-ENS.1x	CM-ENS.2x	CM-ENS.31
General data				
MTBF		on request		
Duty cycle		100 %		
Dimensions		see dimensional drawings		
Weight		see ordering details		
Mounting		DIN rail (IEC/EN 60715), snap-on mounting without any tool		
Mounting position		any		
Minimum distance to other units		CM-ENS.x1: not necessary CM-ENS.x3: 10 mm if contact current > 2 A		
Degree of protection	housing / terminals	IP50 / IP20		
Material of housing		UL 94 V-0		
Electrical connection				
		Screw connection technology		Easy Connect Technology (push-in)
Wire size	fine-strand with(out) wire end ferrule	1 x 0.5-2.5 mm ² (1 x 18-14 AWG)		2 x 0.5-1.5 mm ² (2 x 18-16 AWG)
		2 x 0.5-1.5 mm ² (2 x 18-16 AWG)		
	rigid	1 x 0.5-4 mm ² (1 x 20-12 AWG)		2 x 0.5-1.5 mm ² (2 x 20-16 AWG)
		2 x 0.5-2.5 mm ² (2 x 20-14 AWG)		
Stripping length		8 mm (0.32 in)		
Tightening torque		0.6 - 0.8 Nm (7.08 lb.in)		-
Standards / Directives				
Standard		IEC/EN 60255-27, IEC/EN 60947-5-1		
Low Voltage Directive		2014/35/EU		
RoHS Directive		2014/30/EU		
EMC Directive		2011/65/EU		
Environmental data				
Ambient temperature ranges	operation	-25...+60 °C		
	storage	-40...+85 °C		
Damp heat, cyclic (IEC/EN 60068-2-30)		6 x 24 h cycle, 55 °C, 95 % RH		
Climatic category (IEC/EN 60721-3-3)		3K5 (no condensation, no ice formation)		
Vibration, sinusoidal (IEC/EN 60255-21-1)		class 2		
Shock (IEC/EN 60255-21-2)		class 2		
Isolation data				
Rated impulse withstand voltage U _{imp}	supply circuit / measuring circuit	4 kV		
	supply circuit / output circuits	4 kV		
	measuring circuit / output circuits	4 kV		
	output circuit 1 / output circuit 2	4 kV		
Pollution degree (IEC/EN 60664-1)		3		
Overvoltage category (IEC/EN 60664-1)		III		
Rated insulation voltage U _i	supply circuit / measuring circuit	300 V		
	supply circuit / output circuits	300 V		
	measuring circuit / output circuits	300 V		
	output circuit 1 / output circuit 2	300 V		
Basic insulation	supply circuit / measuring circuit	250 V AC / 300 V DC		
	supply circuit / output circuits	250 V AC / 300 V DC		
	measuring circuit / output circuits	250 V AC / 300 V DC		
	output circuit 1 / output circuit 2	250 V AC / 300 V DC		

Liquid level monitoring relays

Technical data

Type		CM-ENS.1x	CM-ENS.2x	CM-ENS.31
Protective separation (IEC/EN 61140)	supply circuit / measuring circuit	250 V AC / 300 V DC		
	supply circuit / output circuits	250 V AC / 300 V DC		
	measuring circuit / output circuits	250 V AC / 300 V DC		
Pollution degree		3		
Overvoltage category		III		
Electromagnetic compatibility				
Interference immunity to		EN 61000-6-1, EN60255-26		
electrostatic discharge	IEC/EN 61000-4-2	level 3 (6 kV / 8 kV)		
radiated, radio-frequency, electromagnetic field	IEC/EN 61000-4-3	level 3 (10 V/m)		
electrical fast transient / burst	IEC/EN 61000-4-4	level 3, 2 kV / 5 kHz		
surge	IEC/EN 61000-4-5	level 3, installation class 3, supply circuit and measuring circuit 1 kV L-L, 2 kV L-earth		
conducted disturbances, induced by radio- frequency fields	IEC/EN 61000-4-6	level 3, 10 V		
voltage dips, short interruptions and voltage variations	IEC/EN 61000-4-11	class 3		
Interference emission		IEC/EN 61000-6-3, IEC/EN 61000-6-4		
high-frequency radiated	IEC/CISPR 22, EN 55022	class B		
high-frequency conducted	IEC/CISPR 22, EN 55022	class B		

Liquid level monitoring relays

Function diagrams

CM-ENS

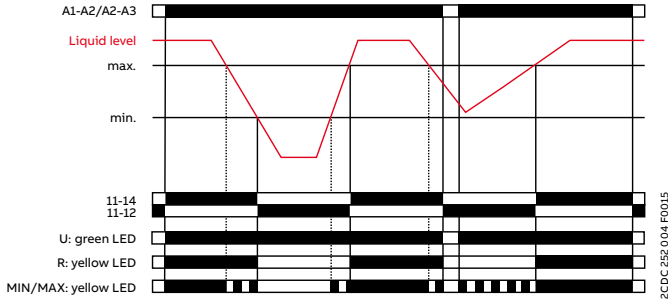

Drain: CM-ENS.1x, CM-ENS.2x

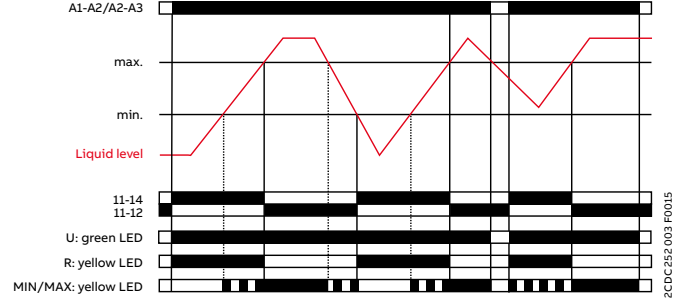

Fill: CM-ENS.2x

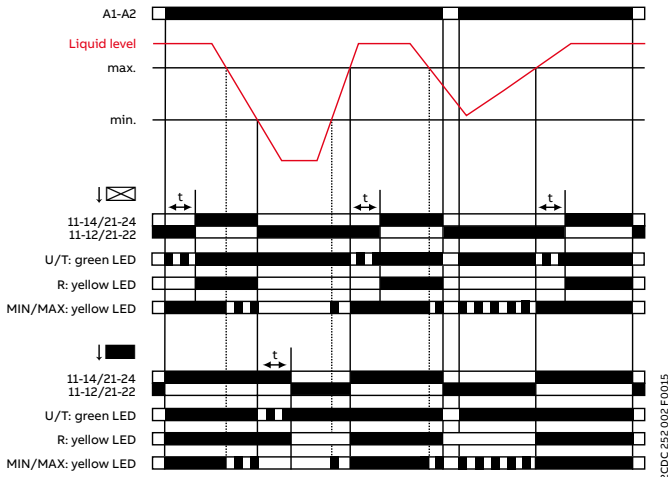

Drain: CM-ENS.31

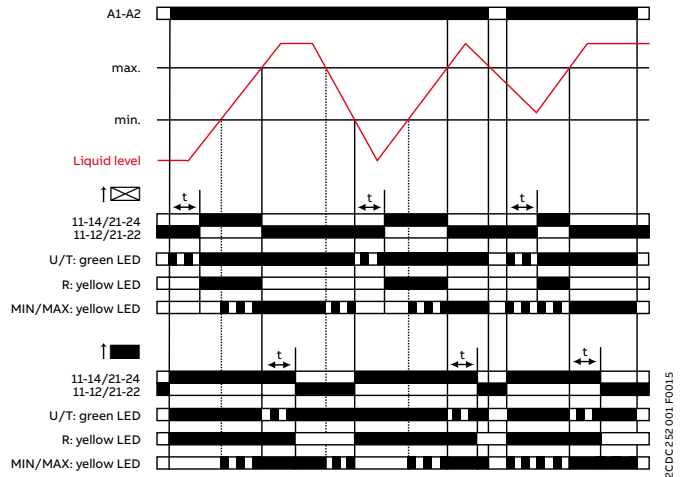

Fill: CM-ENS.31

CM-ENE MIN

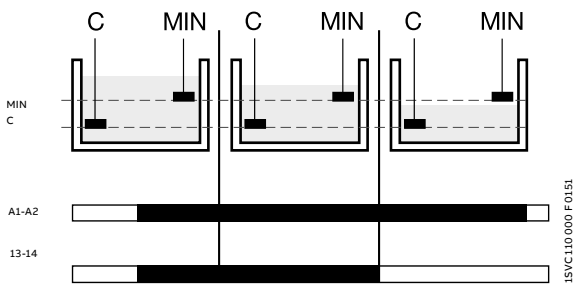

CM-ENE MAX

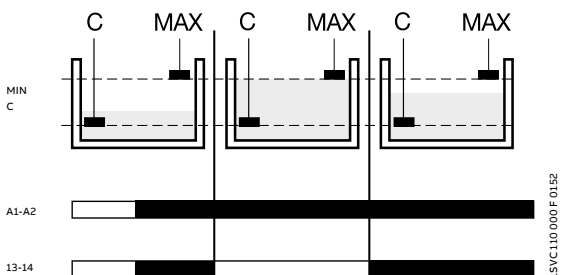

The liquid level relays CM-ENE MIN and CM-ENE MAX are used to monitor levels of conductive liquids, for example, in pump control systems for dry-running or overflow monitoring.

The measuring principle is based on the occurring resistance change when moistening single-pole electrodes. The single-pole electrodes (see also section Accessories) are connected to the terminals C and MIN or MAX.

If the supply voltage is applied to A1-A2 and the electrodes are wet, the output relay of the CM-ENE MIN is energized and the output relay of the CM-ENE MAX is de-energized.

The output relay of the CM-ENE MIN de-energizes if the electrodes are no longer wet. The output relay of the CM-ENE MAX energizes if the electrodes are no longer wet.

Liquid level monitoring relays

Technical diagrams

Connection diagrams

CM-ENS.11x, CM-ENS.21x

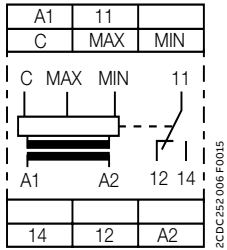

A1-A2	Control supply voltage
11-12/14	1 c/o (SPDT) contact
C	Reference electrode
MAX	Maximum level electrode
MIN	Minimum level electrode

CM-ENS.13x, CM-ENS.23x

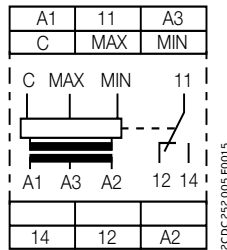

A1-A2	Control supply voltage 220-240 V AC
A3-A2	Control supply voltage 110-130 V AC
11-12/14	1 c/o (SPDT) contact
C	Reference electrode
MAX	Maximum level electrode
MIN	Minimum level electrode

CM-ENS.31x

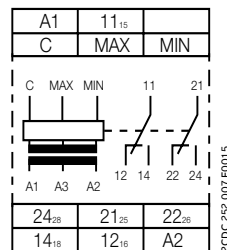

A1-A2	Control supply voltage
11 ₁₅ -12 ₁₆ /14 ₁₈	1 c/o (SPDT) contact
21 ₂₅ -22 ₂₆ /24 ₂₈	2nd c/o (SPDT) contact
C	Reference electrode
MAX	Maximum level electrode
MIN	Minimum level electrode

CM-ENE MIN

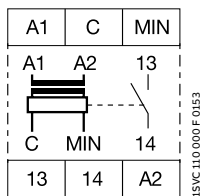

A1-A2	Rated control supply voltage
C	Reference electrode
MIN	Minimum level
13-14	Output contact -open-circuit principle

CM-ENE MAX

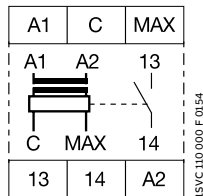

A1-A2	Rated control supply voltage
C	Reference electrode
MIN	Maximum level
13-14	Output contact -open-circuit principle

Liquid level monitoring relays

Technical diagrams

Connection diagrams

CM-ENS.1x

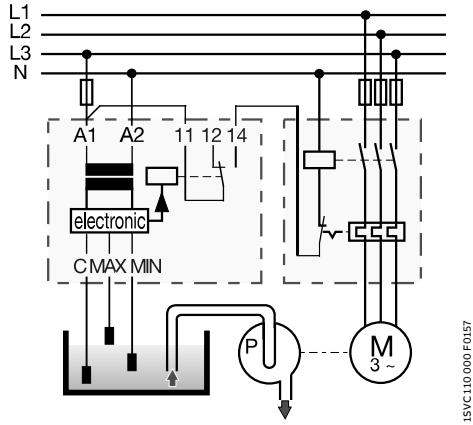

Liquid level control - drain

CM-ENS.2x, CM-ENS.31x

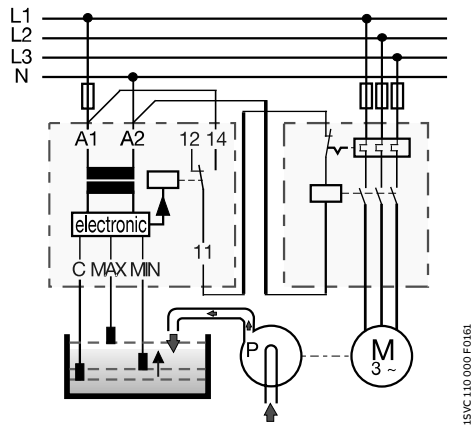

Liquid level control - fill - selected function "↑" (UP)

CM-ENS.2x, CM-ENS.31x

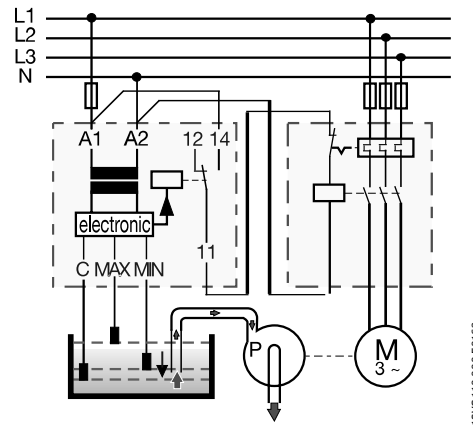

Liquid level control - drain - selected function "↓" (Down)

Liquid level monitoring relays

Technical diagrams

Load limit curves

CM-S (22.5 mm), CM-E (22.5 mm)

AC load (resistive)

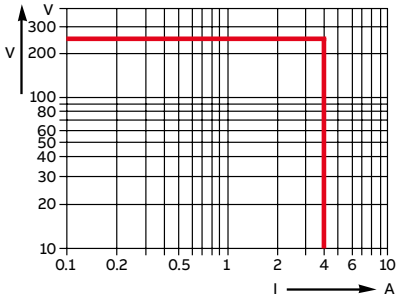

2CDC 252.194 F0205

DC load (resistive)

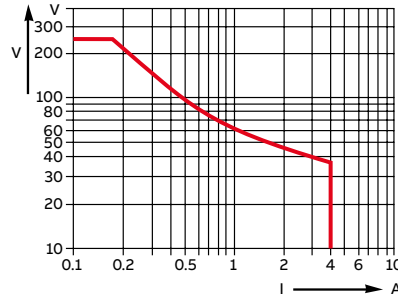

2CDC 252.193 F0205

Derating factor F for inductive AC load

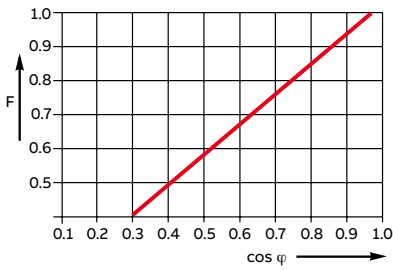

2CDC 252.198 F0205

Contact lifetime

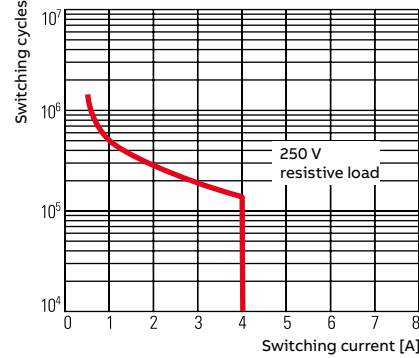

2CDC 252.148 F0206

Dimensional drawing

Dimensions in mm and inches

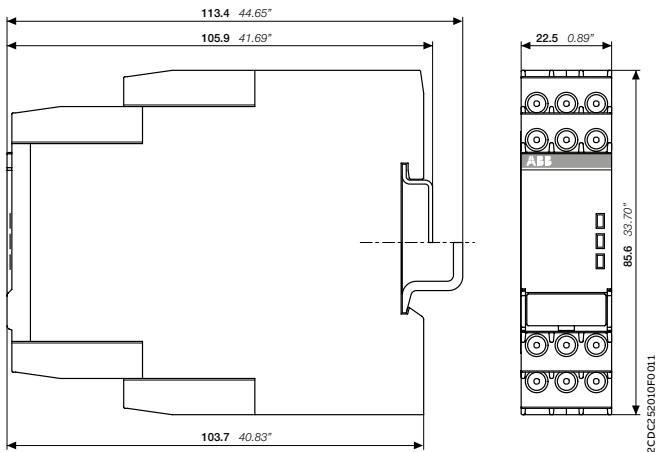

2CDC252010F0011

CM-xxS
1SVR730xxxxxx, 1SVR740xxxxxx



Accessories

Table of contents

262	Ordering details
264	Technical diagrams

Accessories

Ordering details

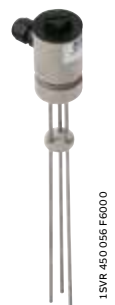

1SVR 450 056 F6000

Bar electrode



1SVC 110 000 F9478

Suspension electrode

Ordering details

Accessories

Description	For type	Width in mm	for devices	Type	Order code	Pkg qty	Weight (1 pc) g (oz)
Adapter for screw mounting	CM-S CM-S.S/P	22.5		ADP.01	1SVR430029R0100	1	18.4 (0.65)
	CM-N CM-N.S/P	45		ADP.02	1SVR440029R0100	1	36.7 (1.30)
Marker label	CM-S, CM-N CM-S.S/P CM-N.S/P		without DIP switches	MAR.01	1SVR366017R0100	10	0.19 (0.007)
	CM-S, CM-N		with DIP switches	MAR.02	1SVR430043R0000	10	0.13 (0.005)
	CM-S.S/P CM-N.S/P		with DIP switches	MAR.12	1SVR730006R0000	10	0.152 (0.335)
Sealable transparent cover	CM-S	22.5		COV.01	1SVR430005R0100	1	5.2 (0.18)
	CM-N	45		COV.02	1SVR440005R0100	1	7.7 (0.27)
	CM-S.S/P	22.5		COV.11	1SVR730005R0100	1	4.0 (0.129)
	CM-N.S/P	45		COV.12	1SVR750005R0100	1	7 (0.247)

Bar electrodes

Description	Material no.	Type	Order code	Weight (1 pc) kg (lb)
Compact support for 3 bar electrodes		CM-KH-3	1SVR450056R6000	0.06 (0.132)
Distance plate for 3 bar electrodes	-	CM-AH-3	1SVR450056R7000	0.06 (0.132)
Counter nut for 1" thread		CM-GM-1	1SVR450056R8000	0.06 (0.132)
Length: 300 mm	1.4301	CM-SE-300	1SVR450056R0000	0.08 (0.176)
Length: 600 mm	1.4301	CM-SE-600	1SVR450056R0100	0.08 (0.176)
Length: 1000 mm	1.4301	CM-SE-1000	1SVR450056R0200	0.08 (0.176)

Suspension electrodes

Description	Connec- tion	Material no.	Type	Order code	Weight (1 pc) kg (lb)
CM-HE suspension electrode high-alloy steel, material no. 1.4104 (according to EN 10088-1)	Screw	1.4104	CM-HE	1SVR402902R0000	0.074 (0.163)
CM-HC suspension electrode high-alloy steel, material no. 1.4104 (according to EN 10088-1)	Crimp	1.4104	CM-HC	1SVR402902R1000	0.09 (0.198)
CM-HCT suspension electrode suitable for drink water high-alloy steel, material no. 1.4301 (according to EN 10088-1)	Crimp	1.4301	CM-HCT	1SVR402902R2000	0.09 (0.198)



For further details, please see the instruction sheet.

Accessories

Ordering details



CM-CT

2CDC251.002 F0005

Plug-in current transformers CM-CT

- Without primary conductor though with foot angle, insulating protective cap and bar fastening screws
- Primary / rated current from 50 A to 600 A
- Secondary current of 1 A or 5 A
- Class 1

Ordering details

Rated primary current	Secondary current	Burden class	Type	Order code	Weight (1 pc) g (oz)
50 A	1 A	1 VA / 1	CM-CT 50/1	1SVR450116R1000	0.31 (0.683)
75 A		1.5 VA / 1	CM-CT 75/1	1SVR450116R1100	0.31 (0.683)
100 A		2.5 VA / 1	CM-CT 100/1	1SVR450116R1200	0.276 (0.608)
150 A		2.5 VA / 1	CM-CT 150/1	1SVR450116R1300	0.32 (0.705)
200 A		2.5 VA / 1	CM-CT 200/1	1SVR450116R1400	0.222 (0.489)
300 A		5 VA / 1	CM-CT 300/1	1SVR450117R1100	0.29 (0.639)
400 A		5 VA / 1	CM-CT 400/1	1SVR450117R1200	0.27 (0.595)
500 A		5 VA / 1	CM-CT 500/1	1SVR450117R1300	0.29 (0.639)
600 A		5 VA / 1	CM-CT 600/1	1SVR450117R1400	0.24 (0.529)
50 A		5 A	1 VA / 1	CM-CT 50/5	1SVR450116R5000
75 A	1.5 VA / 1		CM-CT 75/5	1SVR450116R5100	0.31 (0.683)
100 A	2.5 VA / 1		CM-CT 100/5	1SVR450116R5200	0.31 (0.683)
150 A	2.5 VA / 1		CM-CT 150/5	1SVR450116R5300	0.28 (0.617)
200 A	5 VA / 1		CM-CT 200/5	1SVR450116R5400	0.29 (0.639)
300 A	5 VA / 1		CM-CT 300/5	1SVR450117R5100	0.252 (0.556)
400 A	5 VA / 1		CM-CT 400/5	1SVR450117R5200	0.26 (0.573)
500 A	5 VA / 1		CM-CT 500/5	1SVR450117R5300	0.208 (0.459)
600 A	5 VA / 1		CM-CT 600/5	1SVR450117R5400	0.21 (0.463)



CM-CT with mounted accessories

2CDC251.003 F0005



CM-CT-A mounted on DIN rail

2CDC251.159 F0006

Accessories

Description	Type	Order code	Weight (1 pc) g (oz)
Snap-on fastener for DIN rail mounting of CM-CT	CM-CT A	1SVR450118R1000	0.009 (0.02)

Accessories

Technical diagrams

Operating principle / circuit diagram

CM-CT

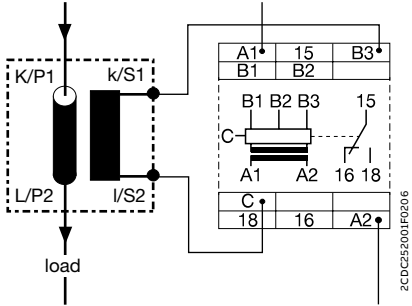

Dimensional drawings in mm and inches

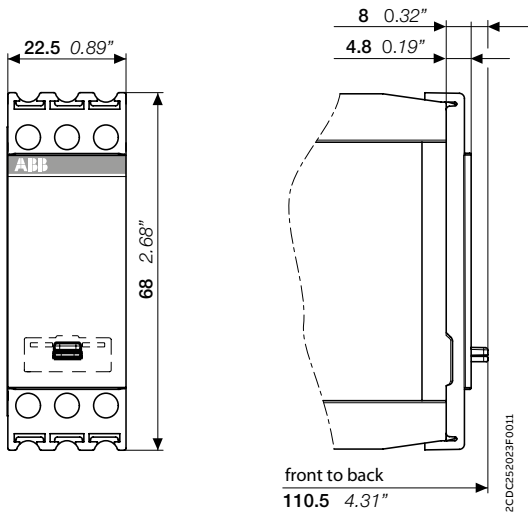

Sealable cover COV:11

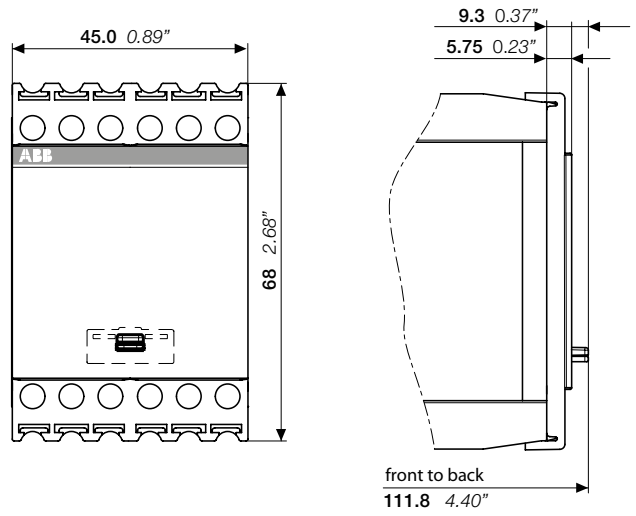

Sealable cover COV:12

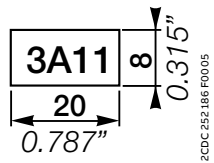

MAR.01

Accessories

Technical diagrams

Dimensional drawings

in mm and inches

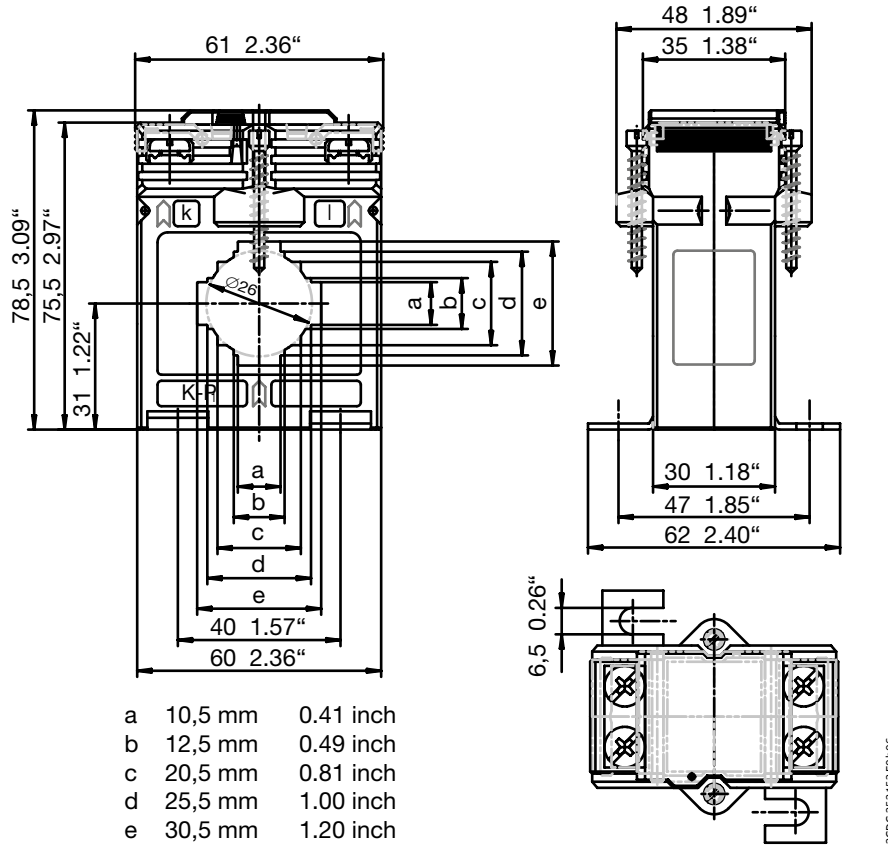

CM-CT

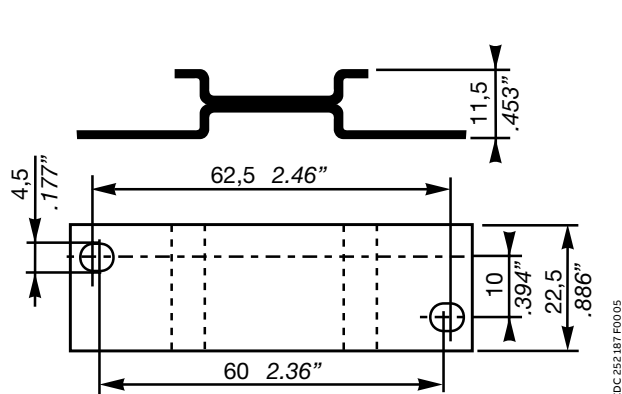

ADP.01

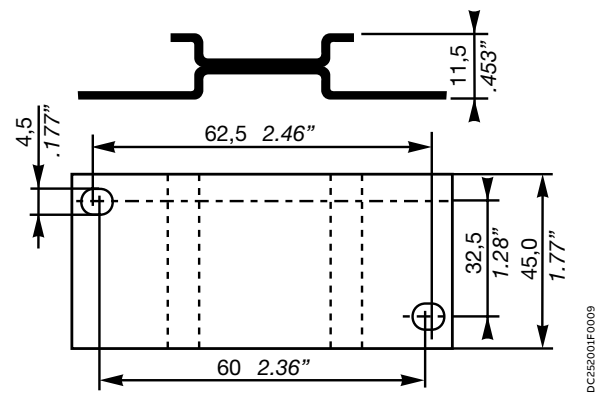

ADP.02



Power supplies

Table of contents

268	Overview
270	Selection table
275	Power supplies for industrial applications
277	CP-E range
297	CP-T range
311	CP-S.1 range
329	CP-C.1 range
353	Power supplies for building applications
354	CP-D range
367	CP-B range
379	Redundancy units
389	Electronic protection devices EPD24

Primary switch mode power supplies

Overview

Modern power supply units are a vital component in energy management and automation technology. As your global partner in these areas, ABB pays the utmost attention to the resulting requirements. Innovation is the key to ABB's power supply product program.

Power supplies for industrial applications



CP-E range: economy range

The CP-E range offers enhanced functionality while the number of different types has been considerably reduced. Now all power supply units can be operated at an ambient temperature of up to +70 °C. The CP-E range 24 V devices over 18 W offer an output/contact for monitoring of the output voltage and remote diagnosis. Optimized for worldwide applications, the CP-E power supplies can be supplied within a wide range of AC or DC voltages. The output voltage is continuously adjustable, ensuring optimal adaptation to the application, e.g. compensating the voltage drop caused by a long line length. For decoupling of parallel connected power supplies below or equal to 56 V, redundancy modules are available in order to achieve true redundancy.



CP-T range: three-phase range

The CP-T range of three-phase power supply units perfectly complements ABB's existing power supply offering in terms of design and functionality, giving you more advanced options for your three-phase applications. Solid state output for function monitoring and remote diagnostics is available. The range is to be used in 340 - 575 V AC or 480 - 820 V DC supply systems. Its continuously adjustable output voltage ensures optimal adaptation to the application, e.g. compensating the voltage drop caused by a long line length.



CP-S.1 range: high-efficiency range

CP-S.1 power supplies: high efficiency and reliability delivered in a compact footprint. Designed for a huge variety of applications, including machine building segments, this advanced range boosts an integrated 150 % power reserve for five seconds and operates at an efficiency of up to 94 %. With overheat protection, active power factor correction, a broad certified AC and DC input range and extensive worldwide approvals including marine, the all-new CP-S.1 power supplies are a preferred choice for multiple industrial applications.

Primary switch mode power supplies

Overview

Power supplies for industrial applications



CP-C.1 range: high-performance range

The CP-C.1 power supplies are ABB's high-performance and most advanced range. With excellent efficiency, high reliability and innovative functionality, the CP-C.1 range is ready to take on the most demanding industrial applications. These power supplies have a 150 % integrated power reserve and operate at an efficiency of up to 94 %. They are equipped with overheat protection and active power factor correction. Combined with a broad AC and DC input range and extensive worldwide approvals, the CP-C.1 power supplies are the preferred choice for professional DC applications. Giving the power to control.



CP-B range: short time buffers

ABB offers an innovative and completely maintenance-free product range for buffering the 24 V DC supply in case of interrupted mains on the primary side of the switch mode power supply.

- Ultra cap based buffer modules for short time UPS systems
- Rated input voltage 24 V DC
- Rated currents 3 A, 10 A and 20 A
- 10 A buffer module with increased capacity to buffer up to 9 min (10 % load)
- LEDs for status indication
- Higher than 90 % efficiency
- Signaling and status outputs
- Buffering times at 100 % load current from 13 s to 50 s (depending on device)

Power supplies for building applications



CP-D range: distribution panel design

The CP-D range of power supply units in MDRC design (modular DIN rail components) fits into all domestic installation and distribution panels. With their width of only 18 to 90 mm, the CP-D range switch mode power supplies are ideally suited for installation in distribution panels. The range is optimized for worldwide applications: The CP-D power supplies can be supplied with 90-264 V AC or 120-375 V DC. The continuously adjustable output voltage (CP-D > 10 W) ensures optimal adaption to the application, e.g. compensating the voltage drop caused by a long line length. An additional redundancy unit CP-D RU to establish true redundancy is available.



For certifications and approvals, please refer to the download section on the product web pages.

Primary switch mode power supplies

Selection table - Single-phase

		Order number																		
		1SVR427033R3000	1SVR427032R1000	1SVR427035R1000	1SVR427030R0000	1SVR427031R0000	1SVR427032R0000	1SVR427034R0000	1SVR427035R0000	1SVR427036R0000	1SVR427030R2000	1SVR427031R2000	1SVR427034R0000	1SVR427035R2000	1SVR427041R1000	1SVR427043R1200	1SVR427041R0000	1SVR427043R0100	1SVR427044R0200	1SVR427045R0400
		Single-phase																		
		CP-E									CP-D									
Rated output voltage	5 V DC	■																		
	12 V DC		■	■											■	■				
	24 V DC				■	■	■	■	■	■						■	■	■	■	■
	48 V DC										■	■	■	■						
Rated output current	0.42 A																			
	0.625 A									■							■			
	0.75 A				■															
	0.83 A														■					
	1.25 A					■														
	1.3 A																	■		
	2.1 A															■				
	2.5 A		■																■	
	3 A	■																	■	
	4.2 A																			■
	5 A								■							■				
	10 A			■						■							■			
20 A										■										
40 A																				
Rated output power	10 W														■		■			
	15 W	■																		
	18 W				■															
	25 W															■				
	30 W		■			■					■						■			
	60 W						■					■						■		
	72 W																		■	
	100 W																			■
	120 W			■				■												
240 W								■					■							
480 W									■					■						
960 W																				
Rated input voltage	100-240 V AC	■	■		■	■	■			■	■			■	■	■	■	■	■	■
	110-240 V AC																			
	115/230 V AC auto select			■				■	■			■								
	115-230 V AC									■				■						
DC input voltage range	90-300 V DC																			
	90-375 V DC		■			■	■				■	■								
	100-250 V DC																			
	110-250 V DC																			
	120-375 V DC	■			■						■				■	■	■	■	■	■
	210-375 V DC			■				■	■					■						
Features	Power reserve design																			
	Adjustable output voltage	■	■	■	■	■	■	■	■	■	■	■	■	■	■	■	■	■	■	■
	Integrated input fuse	■	■	■	■	■	■	■	■	■	■	■	■	■	■	■	■	■	■	■
	Short-circuit stable	■	■	■	■	■	■	■	■	■	■	■	■	■	■	■	■	■	■	■
	Fold-forward behavior (U/I)		■	■		■	■	■	■	■	■	■	■	■		■		■	■	■
	Fold-back behavior (hiccup)	■			■										■		■			
	Power factor correction			pas			pas	pas	act			pas	act							
	Signalling contact					■	■	■	■	■										
	Extended temp. range		■	■		■	■	■	■	■	■	■	■	■	■	■	■	■	■	■
	Parallel connection	■	■	3	■	■	■	3	3	3	■	■	3	3						
	Serial connection	■	■	2	■	■	■	2	2	2	■	■	2	2	■	■	■	■	■	■
	Coated PCBA																			

pas = passive, act = active

Primary switch mode power supplies

Selection table - Three-phase

		Order number	1SVR427054R0000	1SVR427055R0000	1SVR427056R0000	1SVR427057R0000	1SVR427054R2000	1SVR427055R2000	1SVR427056R2000
		Three-phase							
		CP-T							
Rated output voltage	24 V DC	■	■	■	■				
	48 V DC						■	■	■
Rated output current	5 A	■					■		
	10 A		■					■	
	20 A			■					■
	40 A				■				
Rated output power	120 W	■							
	240 W		■				■		
	480 W			■				■	
	960 W				■				■
Rated input voltage	3 x 400-500 V AC	■	■	■	■	■	■	■	■
DC input voltage range	480-820 V DC	■	■	■	■	■	■	■	■
Features	Adjustable output voltage	■	■	■	■	■	■	■	■
	Integrated input fuse	■	■	■	■	■	■	■	■
	Short-circuit stable	■	■	■	■	■	■	■	■
	Fold forward behavior (U/I)	■	■	■			■	■	
	Fold back behavior (hiccup)	■	■	■	■	■	■	■	■
	Extended temp. range	■	■	■	■	■	■	■	■
	Signalling contact	■	■	■	■				
	Parallel connection		2	2	2	2	2	2	2
	Serial connection		2	2	2	2	2	2	2





Power supplies for industrial applications

Table of contents

277	CP-E range
297	CP-T range
311	CP-S.1 range
329	CP-C.1 range



CP-E range

Table of contents

278	Benefits and advantages
280	Operating controls
281	Applications
282	Ordering details
283	Technical data
293	Technical diagrams

CP-E range

Benefits and advantages



ABB's CP-E range offers enhanced functionality and a simpler, more rational selection process. All power supply units can be operated at an ambient temperature of up to +70 °C (158 °F).



Affordable range

Products with exactly the functions you require.
Designed for best possible price-performance ratio.



Global availability

The product can be used in any installations in the world. Giving you the confidence of worldwide sourcing – no matter where you build, install or operate your equipment.



Speed up your projects

Data available for common planning software: Less engineering time required.

CP-E range

Benefits and advantages



Characteristics

- Output voltages 5 V, 12 V, 24 V, 48 V DC
- Adjustable output voltages
- Output currents 0.625 A / 0.75 A / 1.25 A / 2.5 A / 3 A / 5 A / 10 A / 20 A
- Power range 15 W, 18 W, 30 W, 60 W, 120 W, 240 W, 480 W
- High efficiency, up to 90 %
- Low power dissipation and low heating
- Free convection cooling (no forced cooling with ventilators)
- Open-circuit, overload and short-circuit stable
- Integrated input fuse
- U/I characteristic curve on devices > 18 W (fold-forward behavior at overload – no switch-off)
- Redundancy units offering true redundancy
- LED(s) for status indication
- Signalling output/contact for output voltage OK
 - Transistor on 24 V devices > 18 W and < 120 W
 - Solid-state on 24 V devices \geq 120 W
- Various approvals and marks



Main benefits

Signalling output / contact

The CP-E range 24 V devices > 18 W offer an output/contact for monitoring of the output voltage and remote diagnosis.

Wide range input

Optimized for worldwide applications: The CP-E power supplies can be supplied with a wide range of AC or DC voltages.

Adjustable output voltage

A continuously adjustable output voltage ensures optimal adaptation to the application, e.g. compensating the voltage drop caused by a long line length.

Redundancy units

For decoupling of parallelized power supply units \leq 40 A. Thus, true redundancy can be achieved.

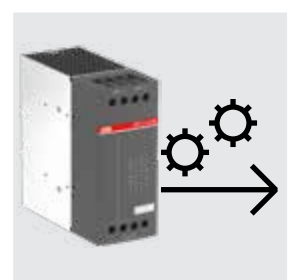

CP-E range

Operating controls

OUTPUT Adjust:
Potentiometer -
adjustment of
output voltage

Single/parallel:
Sliding switch -
adjustment of
single or parallel
operation

**OUTPUT
L+, L+, L-, L-:**
Terminals - output
5 V / 12 V / 24 V /
48 V

13-14:
Terminals -
signalling contact
(or solid-state)

**Indication of
operational states:**
OUTPUT OK:
green LED - output
voltage OK
OUTPUT LOW:
red LED - output
voltage too low

Circuit diagram

INPUT L, N, PE:
terminals - input
90-132 V AC, 180-265 V AC / 210-375 V DC
90-264 V AC / 120-375 V DC
85-264 V AC / 90-375 V DC



CP-E range Applications



Tooling
machines



Packaging
industry



Food
industry



Textile
industry



Printing
industry



Electro-
mobility



CP-E range

Ordering details



2CDC 271 017 F0006

CP-E 5/3.0



2CDC 271 013 F0006

CP-E 12/2.5



2CDC 271 028 F0008

CP-E 48/5.0



2CDC 271 027 F0008

CP-E 24/20.0

Description

This range offers types with output voltages from 5 V DC to 48 V DC at output currents of 0.625 A to 20 A. With their high thermal efficiency of up to 90 %, these power supplies have very low power and heat dissipation and can be operated without forced cooling. The functionality has been enhanced while the number of different types has been considerably reduced.

Of course, all power supplies of the CP-E range are approved in accordance with all relevant international standards.

Ordering details - CP-E < 100 W

Input voltage range	Rated output voltage / current	Type	Order code	Weight (1 pc.) kg (lb)
90-264 V AC / 120-375 V DC	5 V DC / 3 A	CP-E 5/3.0	1SVR427033R3000	0.15 (0.33)
85-264 V AC / 90-375 V DC	12 V DC / 2.5 A	CP-E 12/2.5	1SVR427032R1000	0.29 (0.64)
90-132 V AC, 180-264 V AC / 210-375 V DC	12 V DC / 10 A	CP-E 12/10.0	1SVR427035R1000	1.00 (2.20)
90-264 V AC / 120-375 V DC	24 V DC / 0.75 A	CP-E 24/0.75	1SVR427030R0000	0.15 (0.33)
85-264 V AC / 90-375 V DC	24 V DC / 1.25 A	CP-E 24/1.25	1SVR427031R0000	0.29 (0.64)
85-264 V AC / 90-375 V DC	24 V DC / 2.5 A	CP-E 24/2.5	1SVR427032R0000	0.36 (0.79)





Ordering details - CP-E ≥ 120 W

Input voltage range	Rated output voltage / current	Type	Order code	Weight (1 pc.) kg (lb)
90-132 V AC, 180-264 V AC / 210-375 V DC	24 V DC / 5 A	CP-E 24/5.0	1SVR427034R0000	1.00 (2.20)
90-132 V AC, 180-264 V AC / 210-375 V DC	24 V DC / 10 A	CP-E 24/10.0	1SVR427035R0000	1.36 (3.01)
90-264 V AC / 120-375 V DC	24 V DC / 20 A	CP-E 24/20.0	1SVR427036R0000	1.90 (4.18)
85-264 V AC / 90-375 V DC	48 V DC / 0.625 A	CP-E 48/0.62	1SVR427030R2000	0.29 (0.64)
85-264 V AC / 90-375 V DC	48 V DC / 1.25 A	CP-E 48/1.25	1SVR427031R2000	0.36 (0.79)
90-132 V AC, 180-264 V AC / 210-375 V DC	48 V DC / 5 A	CP-E 48/5.0	1SVR427034R2000	1.36 (3.01)
90-264 V AC / 120-375 V DC	48 V DC / 10 A	CP-E 48/10.0	1SVR427035R2000	1.90 (4.19)

CP-E range

Technical data

Data at $T_a = 25\text{ °C}$, $U_{in} = 230\text{ V AC}$ and rated values, unless otherwise indicated

Type		CP-E 5/3.0	CP-E 12/2.5	CP-E 12/10.0
Input circuit		L, N		
Rated input voltage U_{in}		100-240 V AC		115 / 230 V AC auto select
Input voltage range		90-264 V AC / 120-375 V DC	85-264 V AC / 90-375 V DC	90-132 V AC, 180-264 V AC / 210-375 V DC
Frequency range AC		47-63 Hz		
Typical input current	at 115 V AC	335 mA	560 mA	2.2 A
	at 230 V AC	210 mA	330 mA	0.83 A
Typical power consumption		19.8 W	35.9 W	143 W
Inrush current	at 115 V AC	15 A	20 A	24 A
	at 230 V AC	30 A	40 A	48 A
Discharge current	input / output	0.25 mA		
	input / PE	3.5 mA		
Power failure buffering time	at 115 V AC	min. 20 ms	min. 20 ms	min. 25 ms
	at 230 V AC	min. 75 ms	min. 30 ms	min. 30 ms
Internal input fuse		2 A slow-acting / 250 V AC		3.15 A slow-acting / 250 V AC
Power factor correction (PFC)		no		yes, passive, 0.7
Indication of operational states				
Output voltage	green LED	OK:  : output voltage OK	OUTPUT OK:  : output voltage OK	OUTPUT OK:  : output voltage OK
	red LED	LOW:  : output voltage too low	-	OUTPUT LOW:  : output voltage too low
Output circuit		L+, L-	L+, L+, L-, L-	
Rated output voltage		5 V DC	12 V DC	
Tolerance of the output voltage		0...+1 %		
Adjustment range of the output voltage		4.5-5.75 V DC	12-14 V DC	11.4-14.5 V DC
Rated output power		15 W	30 W	120 W
Rated output current I_r	$T_a \leq 60\text{ °C}$	3.0 A	2.5 A	10 A
Derating of the output current	$60\text{ °C} < T_a \leq 70\text{ °C}$	2.5 %/°C		2.5 %/°C
Maximum deviation with	load change statical	±2 %	±0.5 %	±1 % (single mode) ±5 % (parallel mode)
	change of output voltage within the input voltage range	±1 %	±0.5 %	±0.5 %
Recovery time T_R		< 2 ms		
Starting time after applying the supply voltage	at I_r	max. 1 s		
	with 3500 μF	-	max. 2 s	-
	with 7000 μF	max. 1.5 s	-	max. 1.5 s
Rise time	at rated load	max. 150 ms		
	with 3500 μF	-	max. 500 ms	-
	with 7000 μF	max. 500 ms	-	max. 500 ms
Fall time		max. 150 ms		
Residual ripple and switching peaks	BW = 20 MHz	50 mV		
Parallel connection		yes, to enable redundancy		configurable, to increase power, up to 3 devices, min. 0.1 I_r - max. 0.9 I_r
Series connection		yes, to increase voltage		yes, to increase voltage, max. 2 devices
Resistance to reverse feed		1 s - max. 7.5 V DC	1 s - max. 18 V DC	max. 18 V DC
Output circuit - No-load, overload and short-circuit behavior				
Characteristic curve of output		hiccup-mode	U/I characteristic curve	
Short-circuit protection		continuous short-circuit proof		
Short-circuit behavior		Hiccup-mode	continuation with output power limiting	
Overload protection		output power limiting		
No-load protection		continuous no-load stability		
Starting of capacitive loads		7000 μF	3500 μF	7000 μF

CP-E range

Technical data

Data at $T_a = 25\text{ °C}$, $U_{in} = 230\text{ V AC}$ and rated values, unless otherwise indicated

Type		CP-E 5/3.0	CP-E 12/2.5	CP-E 12/10.0
General data				
Power loss		typ. 5 W	typ. 5.6 W	typ. 24 W
Efficiency		typ. 75 %	typ. 84 %	typ. 84 %
Duty cycle		100 %		
Dimensions		see "Dimensional drawings"		
Material of housing		plastic		metal
Mounting		DIN rail (IEC/EN 60715), snap-on mounting without any tool		
Mounting position		horizontal		
Minimum distance to other units	horizontal / vertical	25 mm / 25 mm (0.98 in / 0.98 in)		
Degree of protection	housing / terminals	IP20 / IP20		
Protection class		I		
Electrical connection - input circuit / output circuit				
Connecting capacity	fine-strand with wire end ferrule			0.2-4 mm ² (24-11 AWG)
	fine-strand without wire end ferrule	0.2-2.5 mm ² (24-14 AWG)		0.2-6 mm ² (24-10 AWG)
	rigid			
Stripping length		6 mm (0.24 in)		8 mm (0.31 in)
Tightening torque	input / output	0.6 Nm (5 lb.in)		1.0 Nm (9 lb.in) / 0.62 Nm (5.5 lb.in)
Environmental data				
Ambient temperature range	operation	-20...+70 °C	-40...+70 °C	-35...+70 °C
	rated load	-20...+60 °C	-40...+60 °C	-35...+60 °C
	storage	-20...+85 °C	-40...+85 °C	-40...+85 °C
Damp heat		95 RH, % without condensation		
Vibration (sinusoidal) (IEC/EN 60068-2-6)		10-500 Hz, 2 G, along X, Y, Z each axis, 60 min. for each axis		
Shock (half-sine) (IEC/EN 60068-2-27)		15 G, 11 ms, 3 axes, 6 faces, 3 times for each face		
Isolation data				
Rated insulation voltage U_i	input circuit / output circuit	3 kV AC		
	input / PE	1.5 kV AC		
	output / PE	0.5 kV AC; 0.71 kV DC		
Pollution degree		2		
Overvoltage category		II		
Standards / Directives				
Standards		IEC/EN62368-1		
Low Voltage Directive		2014/35/EU		
EMC Directive		2014/30/EU		
RoHS Directive		2011/65/EU		
Protective low voltage		SELV (IEC60950-1)		
Electromagnetic compatibility				
Interference immunity to		IEC/EN 61000-6-2		
electrostatic discharge	IEC/EN 61000-4-2	level 4 (air discharge 15 kV / contact discharge 8 kV)		
radiated, radio-frequency, electromagnetic field	IEC/EN 61000-4-3	level 3 (10 V/m)		
electrical fast transient/burst	IEC/EN 61000-4-4	level 4 (4 kV / 2,5 kHz)	level 4 (4 kV / 5 kHz)	
surge	IEC/EN 61000-4-5	L-L level 3 (2 kV) / L-PE level 4 (4 kV)		
conducted disturbances, induced by radio-frequency fields	IEC/EN 61000-4-6	level 3 (10 V)		
power frequency magnetic fields	IEC/EN 61000-4-8	level 4 (30 A/m)		
voltage dips, short interruptions and voltage variations	IEC/EN 61000-4-11	dip: >95 % 10 ms / >30 % 500 ms interruptions: >95 % 5000 ms		
Interference emission		IEC/EN 61000-6-3		
high-frequency radiated		class B		
high-frequency conducted		class B		
limits for harmonic current emissions	IEC/EN 61000-3-2	class D	class A	class D

CP-E range

Technical data

Data at $T_a = 25\text{ °C}$, $U_{in} = 230\text{ V AC}$ and rated values, unless otherwise indicated

Type		CP-E 24/0.75	CP-E 24/1.25	CP-E 24/2.5
Input circuit		L, N		
Rated input voltage U_{in}		100-240 V AC		
Input voltage range		90-264 V AC / 120-375 V DC	85-264 V AC / 90-375 V DC	
Frequency range AC		47-63 Hz		
Typical input current	at 115 V AC	335 mA	560 mA	1060 mA
	at 230 V AC	210 mA	330 mA	590 mA
Typical power consumption		22.8 W	36.7 W	69.2 W
Inrush current	at 115 V AC	15 A	20 A (max. 3 ms)	30 A
	at 230 V AC	30 A	40 A (max. 3 ms)	60 A
Discharge current	input / output	0.25 mA		
	input / PE	3.5 mA		
Power failure buffering time	at 115 V AC	min. 20 ms	min. 20 ms	
	at 230 V AC	min. 75 ms	min. 30 ms	
Internal input fuse		2 A slow-acting / 250 V AC		
Power factor correction (PFC)		no		
Indication of operational states				
Output voltage	green LED	OK: : output voltage OK	OUTPUT OK: : output voltage OK	
	red LED	LOW: : output voltage too low	-	-
Output circuit		L+,L-	L+, L+, L-, L-	
Rated output voltage		24 V DC		
Tolerance of the output voltage		0 ... +1 %		
Adjustment range of the output voltage		21.6-28.8 V DC	24-28 V DC	
Rated output power		18 W	30 W	60 W
Rated output current I_r	$T_a \leq 60\text{ °C}$	0.75 A	1.25 A	2.5 A
Derating of the output current	$60\text{ °C} < T_a \leq 70\text{ °C}$	2.5 %/°C		
Signalling output for output voltage OK	DC OK	-	transistor	
Maximum deviation with	load change statical	±2 %	±0.5 %	
	change of output voltage within the input voltage range	±1 %	±0.5 %	
Recovery time T_R		< 2 ms		
Starting time after applying the supply voltage	at I_r	max. 1 s		
	with 3500 µF	-	max. 2 s	-
	with 7000 µF	max. 1.5 s	-	max. 1.5 s
Rise time	at rated load	max. 150 ms		
	with 3500 µF	-	max. 500 ms	-
	with 7000 µF	max. 500 ms	-	max. 500 ms
Fall time		max. 150 ms		
Residual ripple and switching peaks	BW = 20 MHz	50 mV		
Parallel connection		yes, to enable redundancy		
Series connection		yes, to increase voltage		
Resistance to reverse feed		1 s - max. 35 V DC		
Output circuit - No-load, overload and short-circuit behavior				
Characteristic curve of output		hiccup-mode	U/I characteristic curve	
Short-circuit protection		continuous short-circuit proof		
Short-circuit behavior		hiccup-mode	continuation with output power limiting	
Overload protection		output power limiting		
No-load protection		continuous no-load stability		
Starting of capacitive loads		7000 µF	3500 µF	7000 µF

CP-E range

Technical data



Data at $T_a = 25\text{ °C}$, $U_{in} = 230\text{ V AC}$ and rated values, unless otherwise indicated

Type		CP-E 24/0.75	CP-E 24/1.25	CP-E 24/2.5
General data				
Power loss		typ. 4.45 W	typ. 5.5 W	typ. 8.8 W
Efficiency		typ. 77 %	typ. 86 %	typ. 89 %
Duty cycle		100 %		
Dimensions		see "Dimensional drawings"		
Material of housing		plastic		
Mounting		DIN rail (IEC/EN 60715), snap-on mounting without any tool		
Mounting position		horizontal		
Minimum distance to other units	horizontal / vertical	25 mm / 25 mm (0.98 in / 0.98 in)		
Degree of protection	housing / terminals	IP20 / IP20		
Protection class		I		
Electrical connection - input circuit / output circuit				
Connecting capacity	fine-strand with wire end ferrule	0.2-2.5 mm ² (24-14 AWG)		
	fine-strand without wire end ferrule			
	rigid			
Stripping length		6 mm (0.24 in)		
Tightening torque	input / output	0.6 Nm (5 lb.in)		
Environmental data				
Ambient temperature range	operation	-20...+70 °C	-40...+70 °C	
	rated load	-20...+60 °C	-40...+60 °C	
	storage	-20...+85 °C	-40...+85 °C	
Damp heat (cyclic) (IEC/EN 60068-2-30)		95 % RH, without condensation		
Vibration (sinusoidal) (IEC/EN 60068-2-6)		10-500 Hz, 2 G, along X, Y, Z each axis, 60 min. for each axis		
Shock (half-sine) (IEC/EN 60068-2-27)		15 G, 11 ms, 3 axes, 6 faces, 3 times for each face		
Isolation data				
Rated insulation voltage U_i	input circuit / output circuit	3 kV AC		
	input / PE	1.5 kV AC		
	output / PE	0.5 kV AC; 0.71 kV DC		
Pollution degree		2		
Overvoltage category		II		
Standards / Directives				
Standards		IEC/EN62368-1		
Low Voltage Directive		2014/35/EU		
EMC Directive		2014/30/EU		
RoHS Directive		2011/65/EU		
Protective low voltage		SELV (IEC60950-1)		
Electromagnetic compatibility				
Interference immunity to		IEC/EN 61000-6-2		
electrostatic discharge	IEC/EN 61000-4-2	level 4 (air discharge 15 kV / contact discharge 8 kV)		
radiated, radio-frequency, electromagnetic field	IEC/EN 61000-4-3	level 3 (10 V/m)		
electrical fast transient/burst	IEC/EN 61000-4-4	level 4 (4 kV / 2.5 kHz)	level 4 (4 kV / 5 kHz)	
surge	IEC/EN 61000-4-5	L-L level 3 (2 kV) / L-PE level 4 (4 kV)		
conducted disturbances, induced by radio-frequency fields	IEC/EN 61000-4-6	level 3 (10 V)		
power frequency magnetic fields	IEC/EN 61000-4-8	level 4 (30 A/m)		
voltage dips, short interruptions and voltage variations	IEC/EN 61000-4-11	dip: >95 % 10 ms / >30 % 500 ms, interruptions: >95 % 5000 ms		
Interference emission		IEC/EN 61000-6-3		
high-frequency radiated		class B		
high-frequency conducted		class B		
limits for harmonic current emissions	IEC/EN 61000-3-2	class D	class A	

CP-E range

Technical data

Data at $T_a = 25\text{ °C}$, $U_{in} = 230\text{ V AC}$ and rated values, unless otherwise indicated

Type		CP-E 24/5.0	CP-E 24/10.0	CP-E 24/20.0
Input circuit		L, N		
Rated input voltage U_{in}		115 / 230 V AC auto select		115-230 V AC
Input voltage range		90-132 V AC, 180-264 V AC / 210-375 V DC	90-132 V AC, 180-264 V AC / 210-375 V DC	90-264 V AC, 120-375 V DC
Frequency range AC		47-63 Hz		
Typical input current	at 115 V AC	2.2 A	4.0 A	4.9 A
	at 230 V AC	0.83 A	1.55 A	2.5 A
Typical power consumption		140 W	270 W	539 W
Inrush current	at 115 V AC	24 A (max. 5 ms)	30 A (max. 5 ms)	25 A (max. 5 ms)
	at 230 V AC	48 A (max. 5 ms)	60 A (max. 5 ms)	50 A (max. 5 ms)
Discharge current	input / output	0.25 mA		
	input / PE	3.5 mA		
Power failure buffering time	at 115 V AC	min. 25 ms		
	at 230 V AC	min. 30 ms		
Internal input fuse		3.15 A slow-acting / 250 V AC	6.3 A slow-acting / 250 V AC	10 A slow-acting / 250 V AC
Power factor correction (PFC)		yes, passive, 0.7	yes, passive, 0.75	yes, active 115 V AC: 0.99 230 V AC: 0.97
Indication of operational states				
Output voltage	green LED	OUTPUT OK:  : output voltage OK		
	red LED	OUTPUT LOW:  : output voltage too low		
Output circuit		L+, L+, L-, L-		
Rated output voltage		24 V DC		
Tolerance of the output voltage		0...+1 %		
Adjustment range of the output voltage		22.5-28.5 V DC		
Rated output power		120 W	240 W	480 W
Rated output current I_o	$T_a \leq 60\text{ °C}$	5 A	10 A	-
	$T_a \leq 55\text{ °C}$	-	-	20 A
Derating of the output current	$60\text{ °C} < T_a \leq 70\text{ °C}$	2.5 %/°C		-
	$55\text{ °C} < T_a \leq 70\text{ °C}$	-	-	2.5 %/°C
Signalling contact for output voltage OK	13-14	solid-state (max. 60 V DC, 0.3 A)		
Minimum fuse rating to achieve short-circuit protection	13-14	$\geq 60\text{ V DC}$, $\leq 0.3\text{ A}$ fast-acting		
Maximum deviation with	load change statical	$\pm 1\%$ (single mode), $\pm 5\%$ (parallel mode)		
	change of output voltage within the input voltage range	$\pm 0.5\%$		
Recovery time T_R		< 2 ms		
Starting time after applying the supply voltage	at I_o	max. 1 s	2.5 s (at -40 °C / 90 V AC starting time >2.5 s has to be expected)	max. 1 s
	with 3500 μF	max. 1.5 s	-	-
	with 7000 μF	-	2.5 s	max. 1.5 s
Rise time	at rated load	max. 150 ms		
	with 3500 μF	max. 500 ms	-	-
	with 7000 μF	-	max. 500 ms	-
Fall time		max. 150 ms		
Residual ripple and switching peaks	BW = 20 MHz	50 mV	100 mV	
Parallel connection		configurable, to increase power, up to 3 devices, min. $0.1 I_f$ - max. $0.9 I_f$		
Series connection		yes, to increase voltage, max. 2 devices		
Resistance to reverse feed		max. 35 V DC		

CP-E range

Technical data

Data at $T_a = 25\text{ °C}$, $U_{in} = 230\text{ V AC}$ and rated values, unless otherwise indicated

Type	CP-E 24/5.0	CP-E 24/10.0	CP-E 24/20.0	
Output circuit - No-load, overload and short-circuit behavior				
Characteristic curve of output	U/I characteristic curve			
Short-circuit protection	continuous short-circuit proof			
Short-circuit behavior	continuation with output power limiting			
Overload protection	output power limiting			
No-load protection	continuous no-load stability			
Starting of capacitive loads	3500 μF	7000 μF		
General data				
Power loss	typ. 20 W	typ. 35 W	typ. 63 W	
Efficiency	typ. 86 %	typ. 89 %	typ. 89 %	
Duty cycle	100 %			
Dimensions	see "Dimensional drawings"			
Material of housing	metal			
Mounting	DIN rail (IEC/EN 60715), snap-on mounting without any tool			
Mounting position	horizontal			
Minimum distance to other units	horizontal / vertical	25 mm / 25 mm (0.98 in / 0.98 in)		
Degree of protection	housing / terminals	IP20 / IP20		
Protection class	I			
Electrical connection - input circuit / output circuit				
Connecting capacity	fine-strand with wire end ferrule	0.2-4 mm ² (24-11 AWG)		
	fine-strand without wire end ferrule	0.2-6 mm ² (24-10 AWG)		
	rigid			
Stripping length	8 mm (0.31 in)			
Tightening torque	input / output	1.0 Nm (9 lb.in) / 0.62 Nm (5.5 lb.in)		
Environmental data				
Ambient temperature range	operation	-35...+70 °C	-40...+70 °C	
	rated load	-35...+60 °C	-40...+60 °C	-40...+55 °C
	storage	-40...+85 °C	-40...+85 °C	
Damp heat (cyclic) (IEC/EN 60068-2-30)	95 % RH, without condensation			
Vibration (sinusoidal) (IEC/EN 60068-2-6)	10-500 Hz, 2 G, along X, Y, Z each axis, 60 min. for each axis			
Shock (half-sine) (IEC/EN 60068-2-27)	15 G, 11 ms, 3 axes, 6 faces, 3 times for each face			
Isolation data				
Rated insulation voltage U_i	input circuit / output circuit	3 kV AC		
	input / PE	1.5 kV AC		
	output / PE	0.5 kV AC; 0.71 kV DC		
	signalling contact / PE	0.5 kV DC		
Pollution degree	2			
Overvoltage category	II			
Standards / Directives				
Standards	IEC/EN 62368-1			
Low Voltage Directive	2014/35/EU			
EMC Directive	2014/30/EU			
RoHS Directive	2011/65/EU			
Protective low voltage	SELV (IEC60950-1)			

CP-E range

Technical data



Data at $T_a = 25\text{ °C}$, $U_{in} = 230\text{ V AC}$ and rated values, unless otherwise indicated

Type		CP-E 24/5.0	CP-E 24/10.0	CP-E 24/20.0
Electromagnetic compatibility				
Interference immunity to		IEC/EN 61000-6-2		
electrostatic discharge	IEC/EN 61000-4-2	level 4 (air discharge 15 kV / contact discharge 8 kV)		
radiated, radio-frequency, electromagnetic field	IEC/EN 61000-4-3	level 3 (10 V/m)		
electrical fast transient/burst	IEC/EN 61000-4-4	level 4 (4 kV / 5 kHz)	level 4 (4 kV / 2.5 kHz)	
surge	IEC/EN 61000-4-5	L-L level 3 (2 kV) / L-PE level 4 (4 kV)		
conducted disturbances, induced by radio-frequency fields	IEC/EN 61000-4-6	level 3 (10 V)		
power frequency magnetic fields	IEC/EN 61000-4-8	level 4 (30 A/m)		
voltage dips, short interruptions and voltage variations	IEC/EN 61000-4-11	dip: >95 % 10 ms / >30 % 500 ms interruptions: >95 % 5000 ms		
Interference emission		IEC/EN 61000-6-3		
high-frequency radiated		class B		
high-frequency conducted		class B		
limits for harmonic current emissions	IEC/EN 61000-3-2	class D		

CP-E range

Technical data

Data at $T_a = 25\text{ °C}$, $U_{in} = 230\text{ V AC}$ and rated values, unless otherwise indicated

Type	CP-E 48/0.62	CP-E 48/1.25	CP-E 48/5.0	CP-E 48/10.0
Input circuit	L, N			
Rated input voltage U_{in}	100-240 V AC		115 / 230 V AC auto select	115-230 V AC
Input voltage range	85-264 V AC / 90-375 V DC		90-132 V AC, 180-264 V AC / 210-375 V DC	90-264 V AC, 120-375 V DC
Frequency range AC	47-63 Hz			
Typical input current	at 115 V AC	560 mA	1060 mA	4.0 A
	at 230 V AC	330 mA	590 mA	1.55 A
Typical power consumption		35.7 W	69.0 W	267 W
Inrush current	at 115 V AC	20 A	30 A	30 A (max. 5 ms)
	at 230 V AC	40 A	60 A	60 A (max. 5 ms)
Discharge current	input / output	0.25 mA		
	input / PE	3.5 mA		
Power failure buffering time	at 115 V AC	min. 20 ms		min. 25 ms
	at 230 V AC	min. 30 ms		min. 25 ms
Internal input fuse	2 A slow-acting / 250 V AC		6.3 A slow-acting / 250 V AC	10 A slow-acting / 250 V AC
Power factor correction (PFC)	no		yes, passive, 0.7	yes, active 115 V AC: 0.99 230 V AC: 0.97
Indication of operational states				
Output voltage	green LED	OUTPUT OK:  : output voltage OK		
	red LED	-	-	OUTPUT LOW:  : output voltage too low
Output circuit	L+, L+, L-, L-			
Rated output voltage	48 V DC			
Tolerance of the output voltage	0...+1 %			
Adjustment range of the output voltage	48-55 V DC		47-56 V DC	
Rated output power	30 W	60 W	240 W	480 W
Rated output current I_r	$T_a \leq 60\text{ °C}$	0.625 A	1.25 A	5 A
	$T_a \leq 55\text{ °C}$	-	-	10 A
Derating of the output current	$60\text{ °C} < T_a \leq 70\text{ °C}$	2.5 %/°C		
	$55\text{ °C} < T_a \leq 70\text{ °C}$	-	-	2.5 %/°C
Signalling output for output voltage OK	DC OK	-	-	-
Maximum deviation with	load change statical	$\pm 0.5\%$		$\pm 1\%$ (single mode) $\pm 5\%$ (parallel mode)
	change of output voltage within the input voltage range	$\pm 0.5\%$		$\pm 0.5\%$
Recovery time T_r	< 2 ms			
Starting time after applying the supply voltage	at I_r	max. 1 s		
	with 3500 μF	max. 2 s	-	-
	with 7000 μF	-	max. 1.5 s	max. 1.5 s
Rise time	at rated load	max. 150 ms		
	with 3500 μF	max. 500 ms	-	-
	with 7000 μF	-	max. 500 ms	max. 500 ms
Fall time	max. 150 ms			
Residual ripple and switching peaks	BW = 20 MHz	50 mV		100 mV
Parallel connection	yes, to enable redundancy		configurable, to increase power, up to 3 devices, min. 0.1 I_r - max. 0.9 I_r	
Series connection	yes, to increase voltage		yes, to increase voltage, max. 2 devices	
Resistance to reverse feed	1 s - max. 63 V DC			

CP-E range

Technical data

Data at $T_a = 25\text{ °C}$, $U_{in} = 230\text{ V AC}$ and rated values, unless otherwise indicated

Type	CP-E 48/0.62	CP-E 48/1.25	CP-E 48/5.0	CP-E 48/10.0
Output circuit - No-load, overload and short-circuit behavior				
Characteristic curve of output	U/I characteristic curve			
Short-circuit protection	continuous short-circuit proof			
Short-circuit behavior	continuation with output power limiting			
Overload protection	output power limiting			
No-load protection	continuous no-load stability			
Starting of capacitive loads	3500 μF	7000 μF	unlimited	7000 μF
General data				
Power loss	typ. 4.9 W	typ. 7.8 W	typ. 32 W	typ. 60 W
Efficiency	typ. 86 %	typ. 89 %	typ. 90 %	
Duty cycle	100 %			
Dimensions	see "Dimensional drawings"			
Material of housing	plastic		metal	
Mounting	DIN rail (IEC/EN 60715), snap-on mounting without any tool			
Mounting position	horizontal			
Minimum distance to other units	horizontal / vertical	25 mm / 25 mm (0.98 in / 0.98 in)		
Degree of protection	housing / terminals	IP/20 / IP20		
Protection class	I			
Electrical connection - input circuit / output circuit				
Connecting capacity	fine-strand with wire end ferrule	0.2-2.5 mm ² (24-14 AWG)		0.2-4 mm ² (24-11 AWG)
	fine-strand without wire end ferrule			0.2-6 mm ² (24-10 AWG)
	rigid			
Stripping length		6 mm (0.24 in)	8 mm (0.31 in)	
Tightening torque	input / output	0.6 Nm (5 lb.in)		1.0 Nm (9 lb.in) / 0.62 Nm (5.5 lb.in)
Environmental data				
Ambient temperature range	operation	-40...+70 °C		
	rated load	-40...+60 °C		-40...+55 °C
	storage	-40...+85 °C		
Damp heat (cyclic) (IEC/EN 60068-2-30)	95 % RH, without condensation			
Vibration (sinusoidal) (IEC/EN 60068-2-6)	10-500 Hz, 2 G, along X, Y, Z each axis, 60 min. for each axis			
Shock (half-sine) (IEC/EN 60068-2-27)	15 G, 11 ms, 3 axes, 6 faces, 3 times for each face			
Isolation data				
Rated insulation voltage U_i	input circuit / output circuit	3 kV AC		
	input / PE	1.5 kV AC		
	output / PE	0.5 kV AC; 0.71 kV DC		
Pollution degree	2			
Overvoltage category	II			
Standards / Directives				
Standards	IEC/EN 62368-1			
Low Voltage Directive	2014/35/EU			
EMC Directive	2014/30/EU			
RoHS Directive	2011/65/EU			
Protective low voltage	SELV (IEC60950-1)			

CP-E range

Technical data

Data at $T_a = 25\text{ °C}$, $U_{in} = 230\text{ V AC}$ and rated values, unless otherwise indicated

Type	CP-E 48/0.62	CP-E 48/1.25	CP-E 48/5.0	CP-E 48/10.0
Electromagnetic compatibility				
Interference immunity to	IEC/EN 61000-6-2			
electrostatic discharge	IEC/EN 61000-4-2	level 4 (air discharge 15 kV / contact discharge 8 kV)		
radiated, radio-frequency, electromagnetic field	IEC/EN 61000-4-3	level 3 (10 V/m)		
electrical fast transient/burst	IEC/EN 61000-4-4	level 4 (4 kV / 5 kHz)	level 4 (4 kV / 2.5 kHz)	
surge	IEC/EN 61000-4-5	L-L level 3 (2 kV) / L-PE level 4 (4 kV)		
conducted disturbances, induced by radio-frequency fields	IEC/EN 61000-4-6	level 3 (10 V/m)		
power frequency magnetic fields	IEC/EN 61000-4-8	level 4 (30 A/m)		
voltage dips, short interruptions and voltage variations	IEC/EN 61000-4-11	dip: >95 % 10 ms / >30 % 500 ms, interruptions: >95 % 5000 ms		
Interference emission	IEC/EN 61000-6-3			
high-frequency radiated	class B			
high-frequency conducted	class B			
limits for harmonic current emissions	IEC/EN 61000-3-2	class A	class D	

CP-E range

Technical diagrams

Output curve at $T_a = 25^\circ\text{C}$

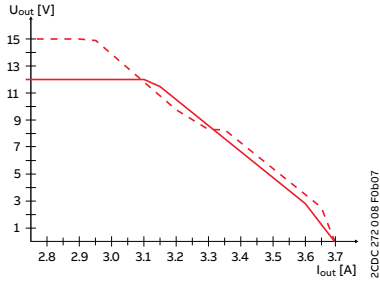

CP-E 12/2.5

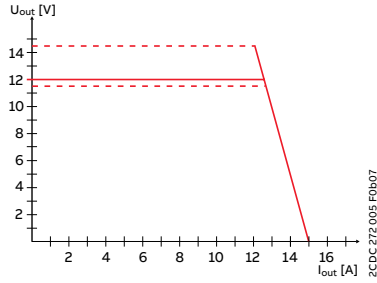

CP-E 12/10.0

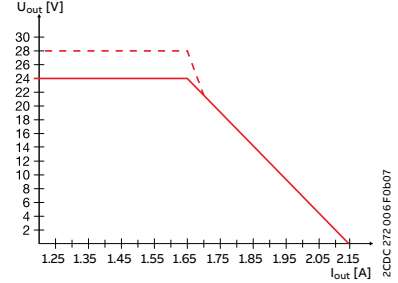

CP-E 24/1.25

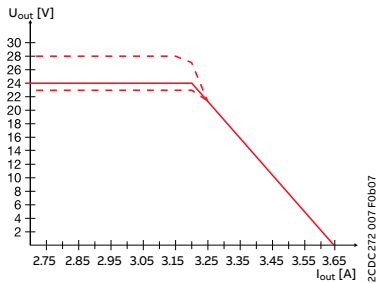

CP-E 24/2.5

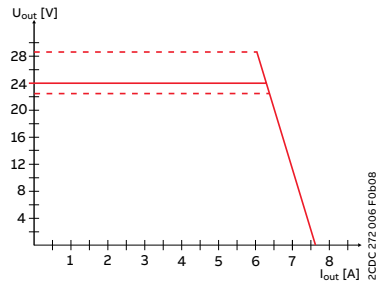

CP-E 24/5.0

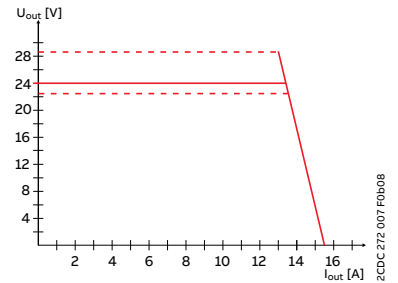

CP-E 24/10.0

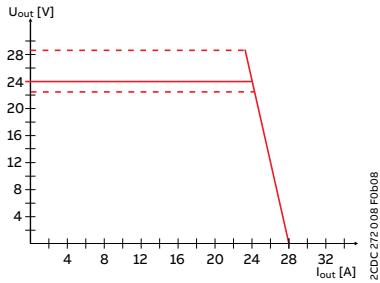

CP-E 24/20.0

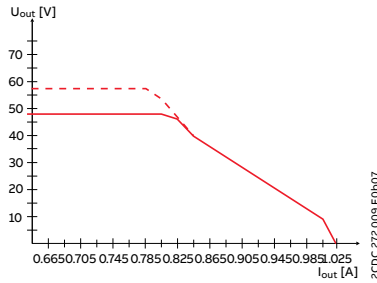

CP-E 48/0.62

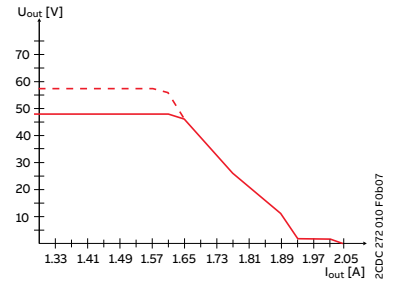

CP-E 48/1.25

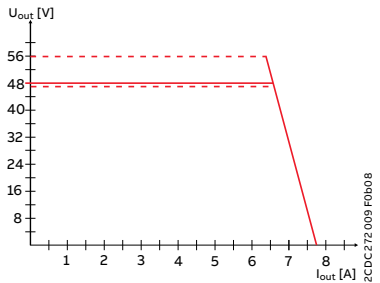

CP-E 48/5.0

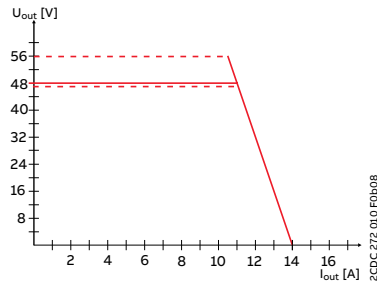

CP-E 48/10.0

CP-E range

Technical diagrams

Temperature behavior

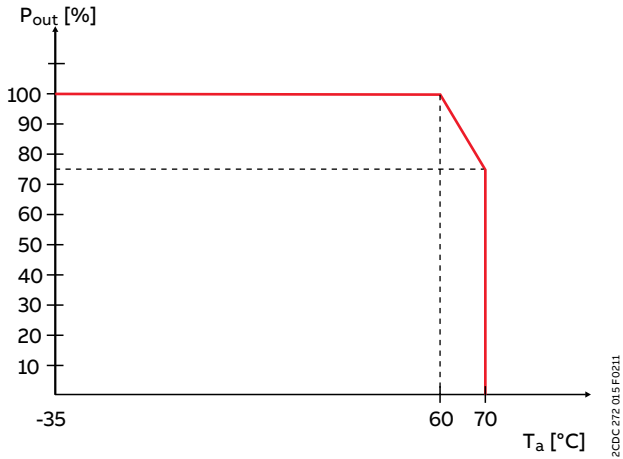

CP-E 12/10.0, CP-E 24/5.0

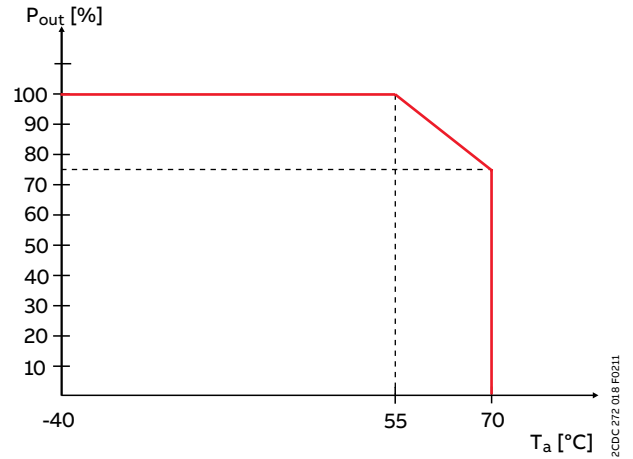

CP-E 24/20.0, CP-E 48/10.0

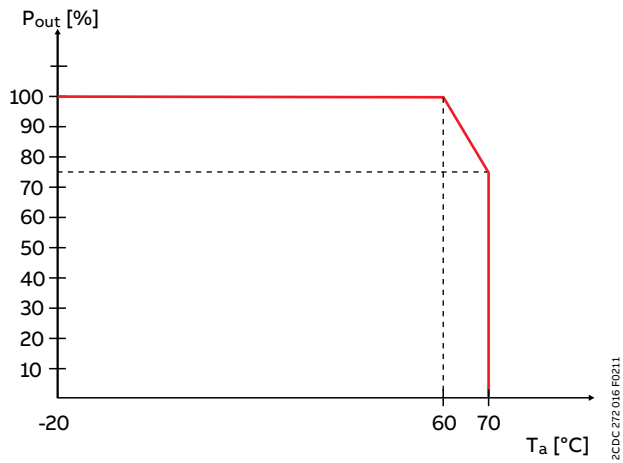

CP-E 5/3.0, CP-E 24/0.75

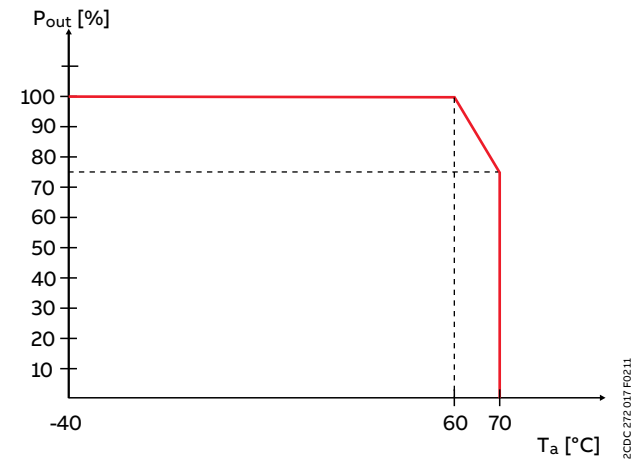

CP-E 12/2.5, CP-E 24/1.25, CP-E 48/0.62,
CP-E 24/2.5, CP-E 48/1.25, CP-E 24/10.0, CP-E 48/5.0

CP-E range

Technical diagrams

Wiring instructions

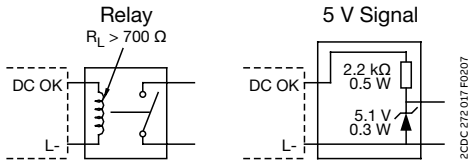

CP-E 24/1.25, CP-E 24/2.5

Dimensional drawings

Dimensions in mm and inches

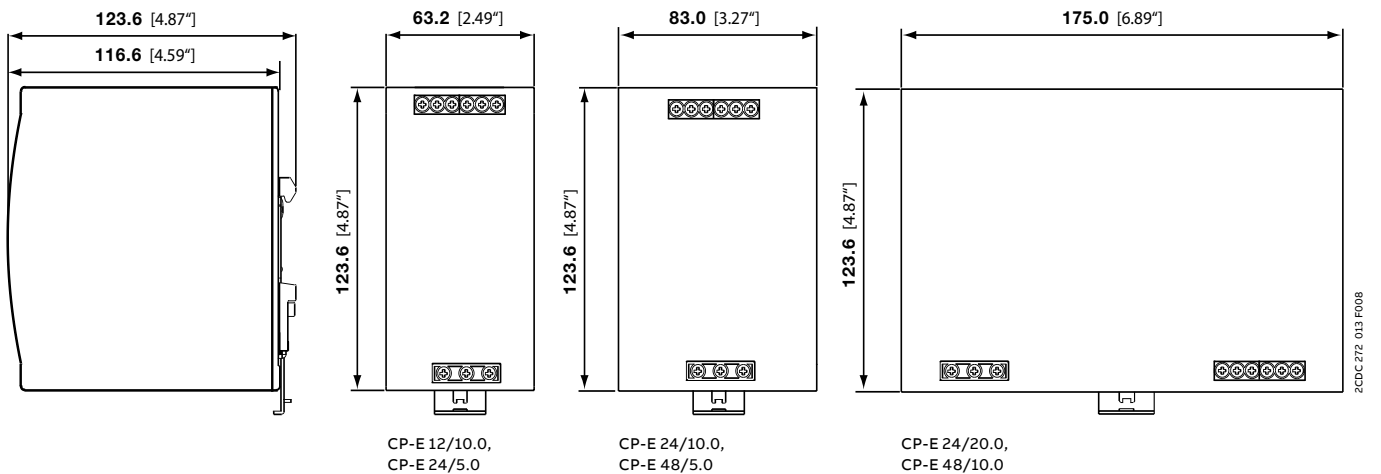
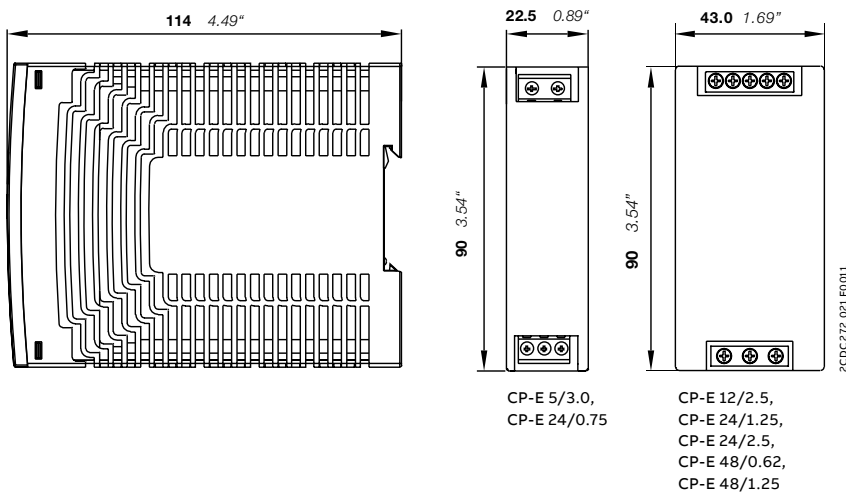



CP-T range

Table of contents

298	Benefits and advantages
300	Operating controls
301	Applications
302	Ordering details
303	Technical data
307	Technical diagrams

CP-T range

Benefits and advantages



ABB's CP-T range of three-phase power supply units perfectly complements our existing power supply offering in terms of design and functionality, giving you more advanced options for your three-phase applications.



Affordable range

Products with exactly the functions you require. Designed for best price-performance ratio.



Global availability

The product can be used in any installation in the world. Giving you the confidence of world-wide sourcing – no matter where you build, install or operate your equipment.



Speed up your projects

Data available for common planning software: Less engineering time required

CP-T range

Benefits and advantages



Characteristics

- Rated output voltages 24 V, 48 V DC
- Output voltage adjustable via front-facing rotary potentiometer "OUTPUT Adjust"
- Rated output currents 5 A, 10 A, 20 A, 40 A
- Rated output powers 120 W, 240 W, 480 W, 960 W
- Three-phase operation (see derating note)
- Two-phase operation (25 % derating possible, see derating note)
- Supply range 3 x 400–500 V AC (3 x 340-575 V AC, 480-820 V DC)
- Typical efficiency of 93 %
- Low power dissipation and low heating
- Free convection cooling (no forced cooling with ventilators)
- Ambient temperature range during operation -40...+70 °C ¹⁾
- Open-circuit, overload and short-circuit stable
- Integrated input fuse
- Redundancy unit CP-C.1-A-RU (-C) offering true redundancy, available as accessory
- LEDs for status indication
- Signalling contact "13-14" (solid-state) for output voltage OK on 24 V devices
- Various approvals and marks

¹⁾ 480 W variants: -30...+70°C



Main benefits

Signalling output

Some devices of the CP-T series offer a solid-state output for function monitoring and remote diagnostics.

Wide input range

Optimized for worldwide applications: The CP-T power supplies can be used in 340 - 575 V AC or 480 - 820 V DC supply systems.

Adjustable output voltage

The CP-T range features a continuously adjustable output voltage. Thus, they can be optimally adapted to the applications, e.g. compensating the voltage drop caused by a long line length.



CP-T range

Operating controls

Indication of operational states

- OUTPUT OK:
green LED -
output voltage OK
- OUTPUT LOW:
red LED -
output voltage
too low

Circuit diagram



INPUT L1, L2, L3, PE:
Terminals - input
340-575 V AC /
480-820 V DC

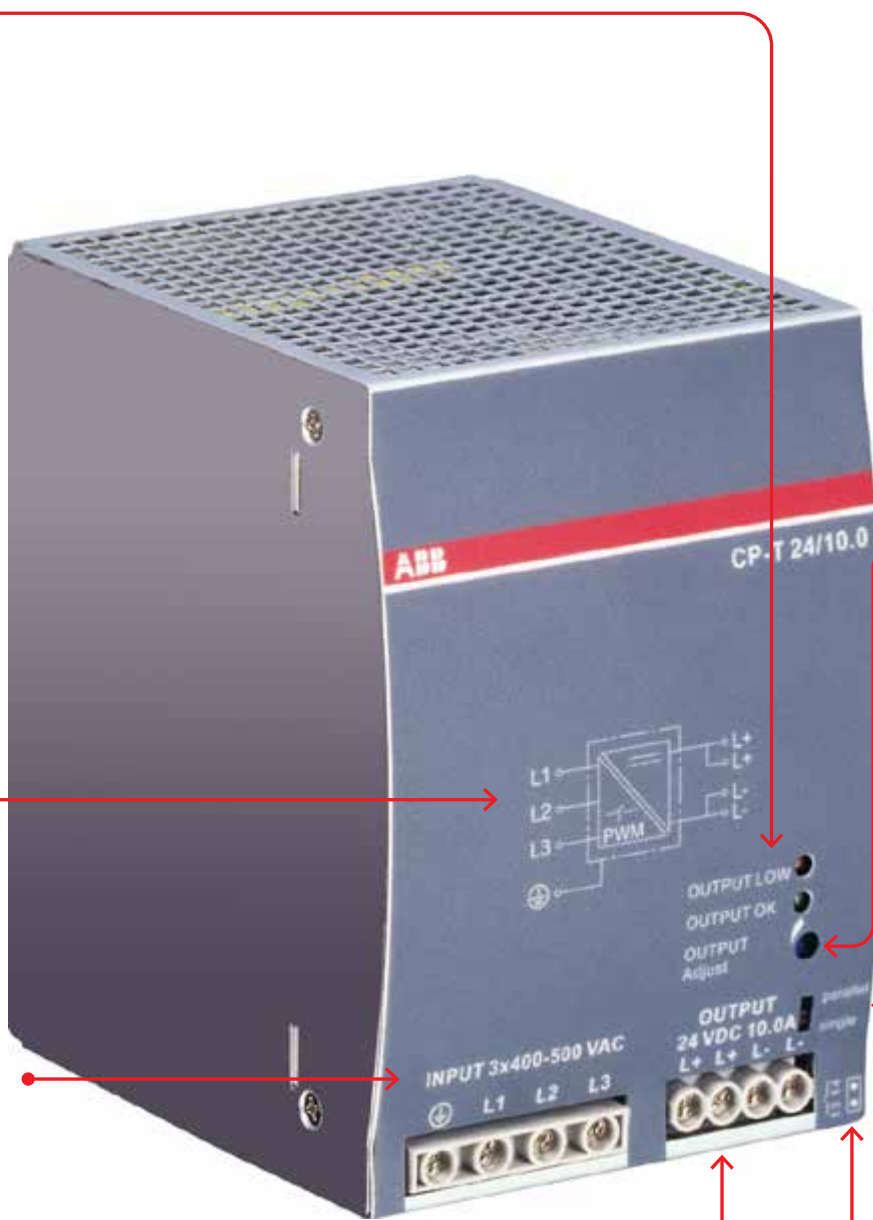

OUTPUT Adjust:
Potentiometer -
adjustment of
output voltage
22.5...28.5V DC

Single/parallel:
Sliding switch -
adjustment of
single or parallel
operation

OUTPUT L+, L+, L-, L-:
Terminals - output
24 V DC, 48 V DC

13-14:
**Terminals - signalling
contact**
A solid-state output
indicates the error-free
operation of the
output voltage



Tunnel drilling machines



Quality power management systems



Floor conveyors

CP-T range

Ordering details



2CDC271.043.50009

CP-T 24/5.0



2CDC271.045.50009

CP-T 24/10.0, CP-T 48/5.0



2CDC271.047.50009

CP-T 24/20.0, CP-T 48/10.0

Description

In terms of design and functionality, the CP-T range perfectly supplements the existing products and extends the range appropriately. The devices can be supplied with a three-phase voltage as well as with two-phase mains. Here, ABB offers power supply units with 24 V DC and 48 V DC outputs with 5 A, 10 A, 20 A and 40 A and efficiency of up to 93 %.

As in the case of all products, they are designed for an ambient temperature of up to 70 °C. All products can be supplied within an AC supply voltage range between 340 to 575 V AC and a DC supply voltage range between 480 to 820 V DC.

Ordering details

Input voltage range	Rated output voltage / current	Type	Order code	Weight (1 pc.) kg (lb)
340-575 V AC / 480-820 V DC	24 V DC / 5 A	CP-T 24/5.0	1SVR427054R0000	0.80 (1.77)
340-575 V AC / 480-820 V DC	24 V DC / 10 A	CP-T 24/10.0	1SVR427055R0000	1.05 (2.31)
340-575 V AC / 480-820 V DC	24 V DC / 20 A	CP-T 24/20.0	1SVR427056R0000	1.75 (3.86)
340-575 V AC / 480-820 V DC	24 V DC / 40 A	CP-T 24/40.0	1SVR427057R0000	3.20 (7.05)
340-575 V AC / 480-820 V DC	48 V DC / 5 A	CP-T 48/5.0	1SVR427054R2000	1.05 (2.31)
340-575 V AC / 480-820 V DC	48 V DC / 10 A	CP-T 48/10.0	1SVR427055R2000	1.75 (3.86)
340-575 V AC / 480-820 V DC	48 V DC / 20 A	CP-T 48/20.0	1SVR427056R2000	3.40 (7.50)

CP-T range

Technical data

Data at $T_a = 25\text{ °C}$, $U_{in} = 3 \times 400\text{ V AC}$ and rated values, unless otherwise indicated

Type	CP-T 24/5.0	CP-T 24/10.0	CP-T 24/20.0	CP-T 24/40.0
Input circuit	L1, L2, L3			
Rated input voltage U_{in}	3 x 400-500 V AC			
Input voltage range	340-575 V AC 480-820 V DC			
Frequency range AC	47-63 Hz			
Typical input current	0.36 A	0.65 A	1.1 A	1.72 A
Typical power consumption	135 W	270 W	538 W	1058 W
Inrush current	typ. 10 A		20 A	
Power failure buffering time	min. 20 ms			min. 15 ms
Internal input fuse	per phase 2 A / 600 V AC		T 3.15 A / 500 V AC	T 5 A / 500 V AC
Recommended backup fuse	3 pole miniature circuit breaker ABB Type S203			
Power factor correction (PFC)	yes, passive			
Discharge current	towards PE		< 3.5 mA	
	input / output		< 0.25 mA	
Indication of operational states				
Output voltage	OUTPUT OK: green LED	output voltage OK when the output voltage > 75 % of the rated output voltage		
	OUTPUT LOW: red LED	output voltage too low when the output voltage < 70 % of the rated output voltage		
Output circuit	L+, L+, L-, L-			
Rated output voltage	24 V DC			
Tolerance of the output voltage	0...+1 %			
Adjustment range of the output voltage	22.5-28.5 V DC			
Rated output power	120 W	240 W	480 W	960 W
Rated output current I_r	$T_a \leq 60\text{ °C}$ 5 A		10 A	20 A
Derating of the output current	$60\text{ °C} < T_a \leq 70\text{ °C}$ 2.5 %/°C		3.5 %/°C	
Signalling contact for output voltage OK	13-14	solid-state (max. 60 V DC, 0.3 A)		
	Threshold	17.6-19.4 V		
	Insulation voltage	500 V DC		
Minimum fuse rating to achieve short-circuit protection	13-14	$\geq 60\text{ V DC}$, $\leq 0.3\text{ A}$ fast-acting		
Maximum deviation with load change statical	$\pm 1\%$		$\pm 1\%$ (single mode)	
	-		$\pm 5\%$ (parallel mode)	
	change of output voltage within the input voltage range		$\pm 0.5\%$	
Recovery time T_A	at nominal load		< 2 ms	
Starting time after applying the supply voltage	at I_r		max. 1 s	
	with 3500 μF		max. 1.5 s	
Rise time	at nominal load		max. 150 ms	
	with 3500 μF		max. 500 ms	
Fall time	max. 150 ms			
Residual ripple and switching peaks	BW = 20 MHz		100 mV	
Parallel connection	not supported	configurable, to increase power, up to 2 devices, min. 0.1 I_r - max 0.9 I_r		to increase power, up to 2 devices, min. 0.1 I_r - max. 0.9 I_r , use active current balancing
Series connection	not supported	yes, to increase voltage, max. 2 devices		
Resistance to reverse feed	approx. 35 V			
Output circuit - No-load, overload and short-circuit behavior				
Characteristic curve of output	combined U/I characteristic curve and hiccup mode		U/I- or hiccup-mode adjustable	hiccup / fold back behavior
Short-circuit protection	continuous short-circuit proof			
Short-circuit behavior	current limiting			
Overload protection	hiccup mode			
No-load protection	continuous no-load stability			
Overtemperature protection	yes, automatic recovery after temperature went down			
Starting of capacitive loads	3500 μF	7000 μF	7000 μF	7000 μF

CP-T range

Technical data

Data at $T_a = 25\text{ °C}$, $U_{in} = 3 \times 400\text{ V AC}$ and rated values, unless otherwise indicated

Type		CP-T 24/5.0	CP-T 24/10.0	CP-T 24/20.0	CP-T 24/40.0
General data					
Efficiency		typ. 89 %	typ. 90 %		typ. 92 %
Duty cycle		100 %			
Dimensions		see "Dimensional drawings"			
Material of housing		metal			
Mounting		DIN rail (IEC/EN 60715), snap-on mounting without any tool			
Mounting position		horizontal			
Minimum distance to other units	horizontal / vertical	25 mm / 25 mm (0.98 in / 0.98 in)			
Degree of protection	housing / terminals	IP20 / IP20			
Protection class		I			
Electrical connection - input circuit / output circuit / signalling circuit					
Connecting capacity	fine-strand with wire end ferrule	0.2-4 mm ² (24-11 AWG)			
	fine-strand without wire end ferrule	0.2-6 mm ² (24-10 AWG)			
	rigid	0.2-6 mm ² (24-10 AWG)			
Stripping length		8 mm (0.31 in)			
Tightening torque	input / output	1 Nm (9 lb.in) / 0.6 Nm (5.5 lb.in)			1 Nm (9 lb.in) / 1.8 Nm (15.6 lb.in)
Environmental data					
Ambient temperature range	operation	-40...+70 °C		-30...+70 °C	-40...+70 °C
	rated load	-40...+60 °C		-30...+60 °C	-40...+60 °C
	storage	-40...+85 °C			
Altitude during operation	IEC/EN 60068-2-13	max. 5000 m			
Damp heat (cyclic) (IEC/EN 60068-2-30)		95 % without condensation			
Vibration (sinusoidal) (IEC/EN 60068-2-6)		10-500 Hz, 2G, each along X, Y, Z axes 60 min / cycle			
Shock (half-sine) (IEC/EN 60068-2-27)		15 g, 11 ms, 3 axes, 6 faces, 3 times for each face			
Isolation data					
Rated insulation voltage U_i	input circuit / output circuit	3 kV AC			
	input / PE	1.5 kV AC			
	output / PE	0.5 kV AC; 0.71 kV DC			
	signalling output / PE	0.5 kV DC			
Pollution degree		2			
Standards / Directives					
Standards		IEC/EN 62368-1			
Low Voltage Directive		2014/35/EU			
EMC Directive		2014/30/EU			
RoHS Directive		2011/65/EU			
Protective low voltage		SELV (IEC60950-1)			
Electromagnetic compatibility					
Interference immunity to		IEC/EN 61000-6-2			
electrostatic discharge	IEC/EN 61000-4-2	level 4 (air discharge 15 kV / contact discharge 8 kV)			
radiated, radio-frequency, electromagnetic field	IEC/EN 61000-4-3	level 3 (10 V/m)			
electrical fast transient/burst	IEC/EN 61000-4-4	level 4 (4 kV / 2.5 kHz)	level 4 (4 kV / 5 kHz)		
surge	IEC/EN 61000-4-5	L-L level 3 (2 kV) / L-PE level 4 (4 kV)			
conducted disturbances, induced by radio-frequency fields	IEC/EN 61000-4-6	level 3 (10 V)			
power frequency magnetic fields	IEC/EN 61000-4-8	level 4 (30 A/m)			
voltage dips, short interruptions and voltage variations	IEC/EN 61000-4-11	dips: >95 % 0.5 ms / >30 % 0.5 ms, interruptions: >95 % 250 ms			
Interference emission		IEC/EN 61000-6-3			
high-frequency radiated		class B			
high-frequency conducted		class B			
limits for harmonic current emissions	IEC/EN 61000-3-2	class A			

CP-T range

Technical data

Data at $T_a = 25\text{ °C}$, $U_{in} = 3 \times 400\text{ V AC}$ and rated values, unless otherwise indicated

Type	CP-T 48/5.0	CP-T 48/10.0	CP-T 48/20.0
Input circuit	L1, L2, L3		
Rated input voltage U_{in}	3 x 400-500 V AC		
Input voltage range	340-575 V AC 480-820 V DC		
Frequency range AC	47-63 Hz		
Typical input current	0.65 A	1.1 A	1.72 A
Typical power consumption	264 W	535 W	1050 W
Inrush current	typ. 20 A		30 A
Power failure buffering time	min. 20 ms		min. 15 ms
Internal input fuse	per phase 2 A / 600 V AC	T 3.15 A / 500 V AC	T 5 A / 500 V AC
Power factor correction (PFC)	yes, passive		
Discharge current	towards PE	< 3.5 mA	
	input / output	< 0.25 mA	
Indication of operational states			
Output voltage	OUTPUT OK: green LED	output voltage OK when the output voltage > 75 % of the rated output voltage	
	OUTPUT LOW: red LED	output voltage too low when the output voltage < 70 % of the rated output voltage	
Output circuit	L+, L+, L-, L-		
Rated output voltage	48 V DC		
Tolerance of the output voltage	0...+1 %		
Adjustment range of the output voltage	47-56 V DC		
Rated output power	240 W	480 W	960 W
Rated output current I_r	$T_a \leq 60\text{ °C}$ 5 A	10 A	20 A
Derating of the output current	$60\text{ °C} < T_a \leq 70\text{ °C}$	2.5 %/°C	
Maximum deviation with	load change statical	$\pm 1\%$ (single mode) $\pm 5\%$ (parallel mode)	
	change of output voltage within the input voltage range	$\pm 0.5\%$	
Recovery time T_A	at rated load	< 2 ms	
Starting time after applying the supply voltage	at I_r	max. 1 s	
	with 7000 μF	max. 1.5 s	
Rise time	at rated load	max. 150 ms	
	with 7000 μF	max. 500 ms	
Fall time		max. 150 ms	
Residual ripple and switching peaks	BW = 20 MHz	100 mV	80 mV
Parallel connection		configurable, to increase power, up to 2 devices, min. 0.1 I_r - max 0.9 I_r	to increase power, up to 2 devices, min. 0.1 I_r - max. 0.9 I_r , use active current balancing
Series connection		yes, to increase voltage, max. 2 devices	
Resistance to reverse feed		approx. 35 V	approx. 63 V
		approx. 63 V	approx. 63 V
Output circuit - No-load, overload and short-circuit behavior			
Characteristic curve of output	combined U/I and hiccup mode	U/I or hiccup mode, configurable	hiccup mode / fold back behavior
Short-circuit protection	continuous short-circuit proof		
Short-circuit behavior	current limiting		
Overload protection	hiccup mode		
No-load protection	continuous no-load stability		
Over temperature protection	yes, automatic recovery after temperature went down		
Starting of capacitive loads	7000 μF		

CP-T range

Technical data

Data at $T_a = 25\text{ °C}$, $U_{in} = 3 \times 400\text{ V AC}$ and rated values, unless otherwise indicated

Type		CP-T 48/5.0	CP-T 48/10.0	CP-T 48/20.0
General data				
Efficiency		typ. 91 %		typ. 93 %
Duty cycle		100%		
Dimensions		see "Dimensional drawings"		
Material of housing		Metal		
Mounting		DIN rail (IEC/EN 60715), snap-on mounting without any tool		
Mounting position		horizontal		
Minimum distance to other units	horizontal / vertical	25 mm / 25 mm (0.98 in / 0.98 in)		
Degree of protection	housing / terminals	IP20 / IP20		
Protection class		I		
Electrical connection - input circuit / output circuit				
Connecting capacity	fine-strand with wire end ferrule	0.2-4 mm ² (24-11 AWG)		0.2-4 mm ² (24-11 AWG) / 0.5-10 mm ² (20-8 AWG)
		0.2-6 mm ² (24-10 AWG)		
		rigid		
Stripping length		8 mm (0.31 in)		
Tightening torque	input / output	1 Nm (9 lb.in) / 0.6 Nm (5.5 lb.in)		1 Nm (9 lb.in) / 1.8 Nm (15.6 lb.in)
Environmental data				
Ambient temperature range	operation	-40...+70 °C	-30...+70 °C	-40...+70 °C
	rated load	-40...+60 °C	-30...+60 °C	-40...+60 °C
	storage	-40...+85 °C	-40...+85 °C	-40...+85 °C
Altitude during operation	IEC/EN 60068-2-13	max. 5000 m		
Damp heat (cyclic) (IEC/EN 60068-2-30)		95 % without condensation		
Vibration (sinusoidal) (IEC/EN 60068-2-6)		10-500 Hz, 2G, each along X, Y, Z axes 6 min / cycle		
Shock (half-sine) (IEC/EN 60068-2-27)		15G, 11 ms, 3 axes, 6 Faces, 3 times for each face		
Isolation data				
Rated insulation voltage U_i	input circuit / output circuit	3 kV AC		
	input / PE	1.5 kV AC		
	output / PE	0.5 kV AC; 0.71 kV DC		
Pollution degree		2		
Standards / Directives				
Standards		IEC/EN 62368-1		
Low Voltage Directive		2014/35/EU		
EMC Directive		2014/30/EU		
RoHS Directive		2011/65/EU		
Protective low voltage		SELV (IEC60950-1)		
Electromagnetic compatibility				
Interference immunity to		IEC/EN 61000-6-2		
electrostatic discharge	IEC/EN 61000-4-2	level 4 (air discharge 15 kV / contact discharge 8 kV)		
radiated, radio-frequency, electromagnetic field	IEC/EN 61000-4-3	level 3 (10 V/m)		
electrical fast transient/burst	IEC/EN 61000-4-4	level 4 (4 kV / 5 kHz)		
surge	IEC/EN 61000-4-5	L-L level 3 (2 kV) / L-PE level 4 (4 kV)		
conducted disturbances, induced by radio-frequency fields	IEC/EN 61000-4-6	level 3 (10 V)		
power frequency magnetic fields	IEC/EN 61000-4-8	level 4 (30 A/m)		
voltage dips, short interruptions and voltage variations	IEC/EN 61000-4-11	dips: >95 % 0.5 ms / >30 % 0.5 ms interruptions: >95 % 250 ms		
Interference emission		IEC/EN 61000-6-3		
high-frequency radiated		class B		
high-frequency conducted		class B		
limits for harmonic current emissions	IEC/EN 61000-3-2	class A		

CP-T range

Technical diagrams

Output curves at $T_a = 25^\circ\text{C}$

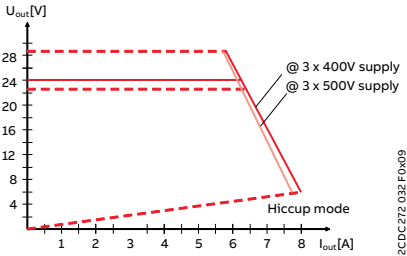

CP-T 24/5.0

2CDC272.032.F0x09

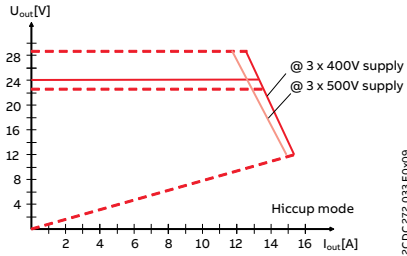

CP-T 24/10.0

2CDC272.033.F0x09

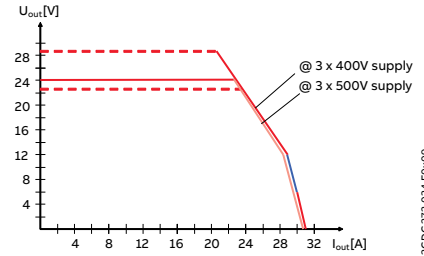

CP-T 24/20.0 U/I curve

2CDC272.034.F0x09

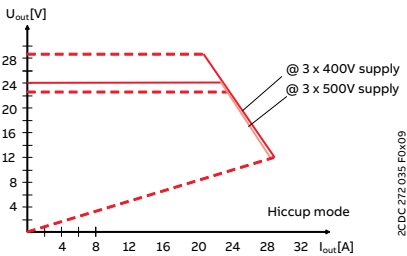

CP-T 24/20.0 Hiccup mode

2CDC272.035.F0x09

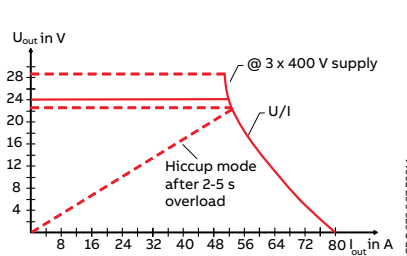

CP-T 24/40.0

2CDC272.027.F0211

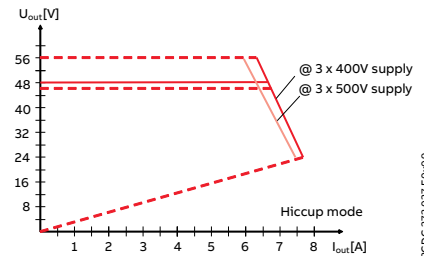

CP-T 48/5.0

2CDC272.037.F0x09

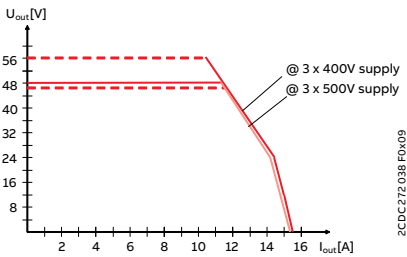

CP-T 48/10.0 U/I curve

2CDC272.038.F0x09

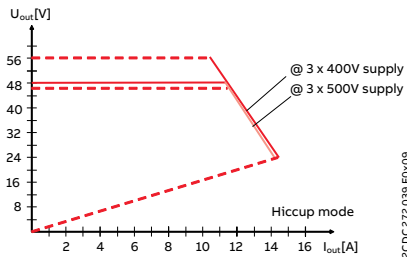

CP-T 48/10.0 Hiccup mode

2CDC272.039.F0x09

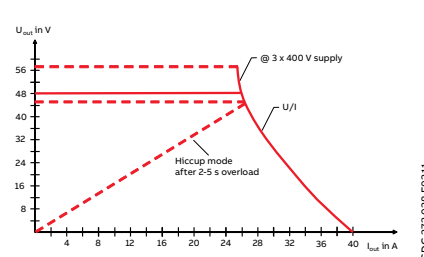

CP-T 48/20.0

2CDC272.038.F0211

Temperature curves at rated load

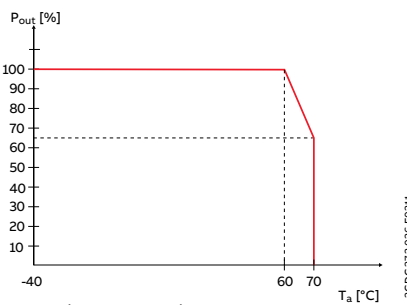

CP-T 24/40.0, CP-T 48/20.0

2CDC272.026.F0211

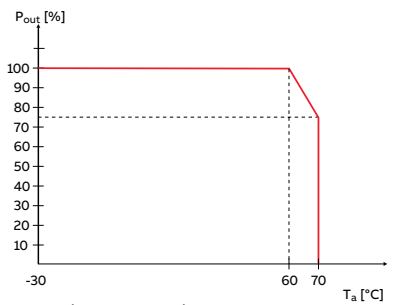

CP-T 24/20.0, CP-T 48/10.0

2CDC272.030.F0211

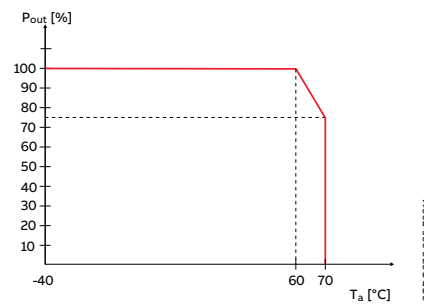

CP-T 24/5.0, CP-T 24/10.0, CP-T 48/5.0

2CDC272.025.F0211

CP-T range

Technical diagrams

Dimensional drawings

Dimensions in mm and inches

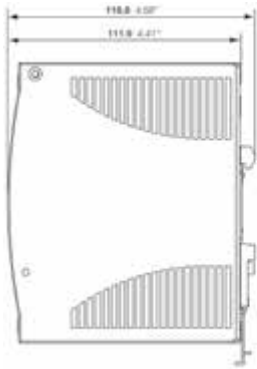

CP-T 24/5.0

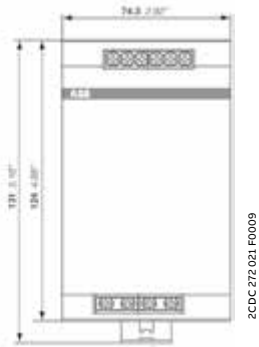

2CDC 272 021 F0009

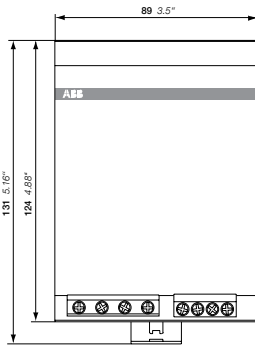

2CDC 272 022 F0009

CP-T 24/10.0, CP-T 48/5.0

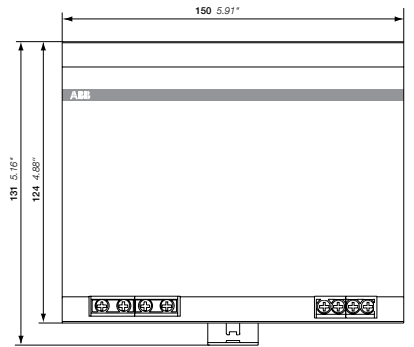

2CDC 272 023 F0009

CP-T 24/20.0, CP-T 48/10.0

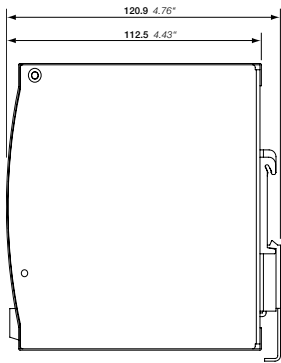

CP-T 24/40.0, CP-T 48/20.0

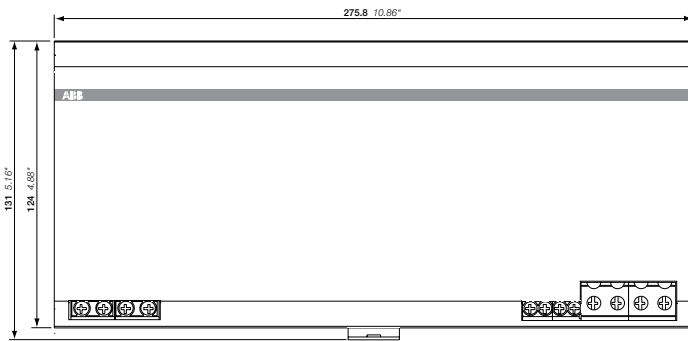

2CDC 272 011 F0016





CP-S.1 range

Table of contents

312	Benefits and advantages
314	Operating controls
316	Characteristics
318	Application example
318	Softstarter and Safety ^{*)}
319	Food & beverage ^{*)}
320	Ordering details
321	Technical data
325	Technical diagrams

CP-S.1 power supply range

Benefits and advantages



CP-S.1 power supplies: high efficiency and reliability delivered in a compact footprint. Designed for a huge variety of applications, including machine building segments, this advanced range boosts an integrated 150 % power reserve for five seconds and operates at an efficiency of up to 94 %. With overheat protection, active power factor correction, a broad certified AC and DC input range and extensive worldwide approvals including marine, the all-new CP-S.1 power supplies are a preferred choice for multiple industrial applications.

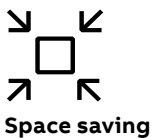

Outstanding power to space ratio

In comparison to other power supply ranges on the market, ABB's CP-S.1 range achieves space savings up to 50 %. Together with the high-efficiency and reduced power losses features, CP-S.1 is a space and cost saving solution for applications where size matters.

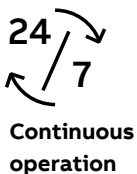

System reliability

The power reserve functionality provides additional power of starting heavy loads. CP-S.1 offers 150 % of the nominal current for five seconds to start e.g. heavy loads reliably. Together with ABB's redundancy modules CP-C.1-A-RU as well as buffer modules CP-B range - buffering the load in case of power losses on grid side - increase the availability and finally the system reliability further. Coated PCBA completes CP-S.1 range offering for OEM machine builders.



Global availability

CP-S.1 range can be used in multiple installations in the world. A certified wide AC and DC input voltage range as well as a variety of approvals incl. marine, giving you the confidence of world-wide sourcing – no matter where you build, install or operate your equipment.

CP-S.1 power supply range

CO₂ reduction



CP-S.1 power supplies operate at an astonishing efficiency of up to 94%. By increasing the efficiency by just 2 %, 1,4 tons of CO₂ can be saved over the lifetime of ten years of a 40 A power supply at nominal load. This corresponds to the CO₂ emissions of 167.000 numbers of smartphone charges.

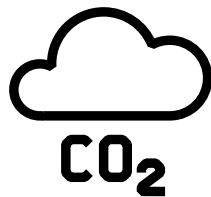

1400
kilograms of CO₂
reduction over the
lifetime

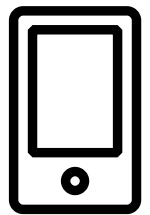

>160,000
Smartphones
charged



Main benefits

Complete offering

A complete 24 V DC offering from 3 A up to 40 A in metal enclosure suits perfectly to OEM machine building requirements.

Small footprint

CP-S.1 power supplies can save the valuable installation space of the control cabinet due to compact design and high efficiency.

Robust design

Coated PCBA and marine certification enable CP-S.1 power supplies being the perfect match for e.g. Wind, Solar, Marine applications.

Redundancy units

True redundancy could be achieved by using the optional redundancy unit CP-C.1-A-RU.

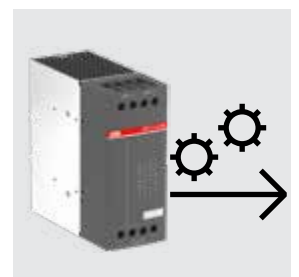

CP-S.1 power supplies

Operating controls

OUTPUT L+, L-:
Output terminals
24 V DC

OUTPUT Adjust:
Rotary potentiometer - Adjustment of
output voltage
24-28 V DC

Circuit diagram



**Additional L(-)
terminal for e.g.
grounding**

13-14: Relay output
Relay output to
signal 'Output OK'

**OUTPUT OK: green
LED for indication of
24 V DC**

- on: output voltage
>92% of adjusted
voltage
- flashes: output
voltage <90% of
adjusted voltage

INPUT L(+), N(-), PE*:
Input terminals
100 - 240 V AC /
100 - 250 V DC

—
CP-S.1 power supplies not only take up less space in the control cabinet, but also help reduce environmental impact.



CP-S.1 power supplies

Characteristics



Characteristics

- Rated supply voltage range from 100-240 V AC / 100-250 V DC
- Rated output voltage 24 V DC
- Rated output current of 3.0 A, 5.0 A, 10.0 A, 20.0 A and 40.0 A
- High efficiency of up to 94 %
- Power reserve design of 150 % for 5 s
- Output voltage adjustable via front-face rotary potentiometer "OUTPUT Adjust", 24-28 V
- Low power dissipation and low heating
- Free convection cooling (no forced cooling)
- Coated PCBAs
- Open-circuit, overload and short-circuit protection
- Integrated input fuse
- DC OK - signaling output "13-14" (relay)
- CP-C.1-A-RU redundancy unit offers true redundancy, available as accessory
- Various approvals and marks



Thanks to their small footprint and high efficiency, CP-S.1 power supplies are versatile and with their wide application range, they can be found everywhere, including the ones listed below.



Robotics



Material handling



Packaging



EV charging



Food & Beverage



Genset/UPS



Marine



Renewables

CP-S.1 power supplies

Application example Softstarter and Safety^{*)}

A sawmill or lumber mill is a facility where logs are processed into lumber. Modern sawmills use a motorized saw to cut logs lengthwise to make long pieces, and crosswise to determine length according to standard or custom sizes (dimension lumber). The "portable" sawmill is of simple operation. The log lies flat on a steel bed, and the motorized saw cuts the log horizontally along the length of the bed by the operator manually pushing the saw. The simplest type of sawmill consists of a chainsaw and a custom-made jig ("Alaskan sawmill"), with similar horizontal operation. Energy management is a point of great interest.

Application example: Softstarter and Safety (SIL3/PLe, motor power/starting: <15 kW)

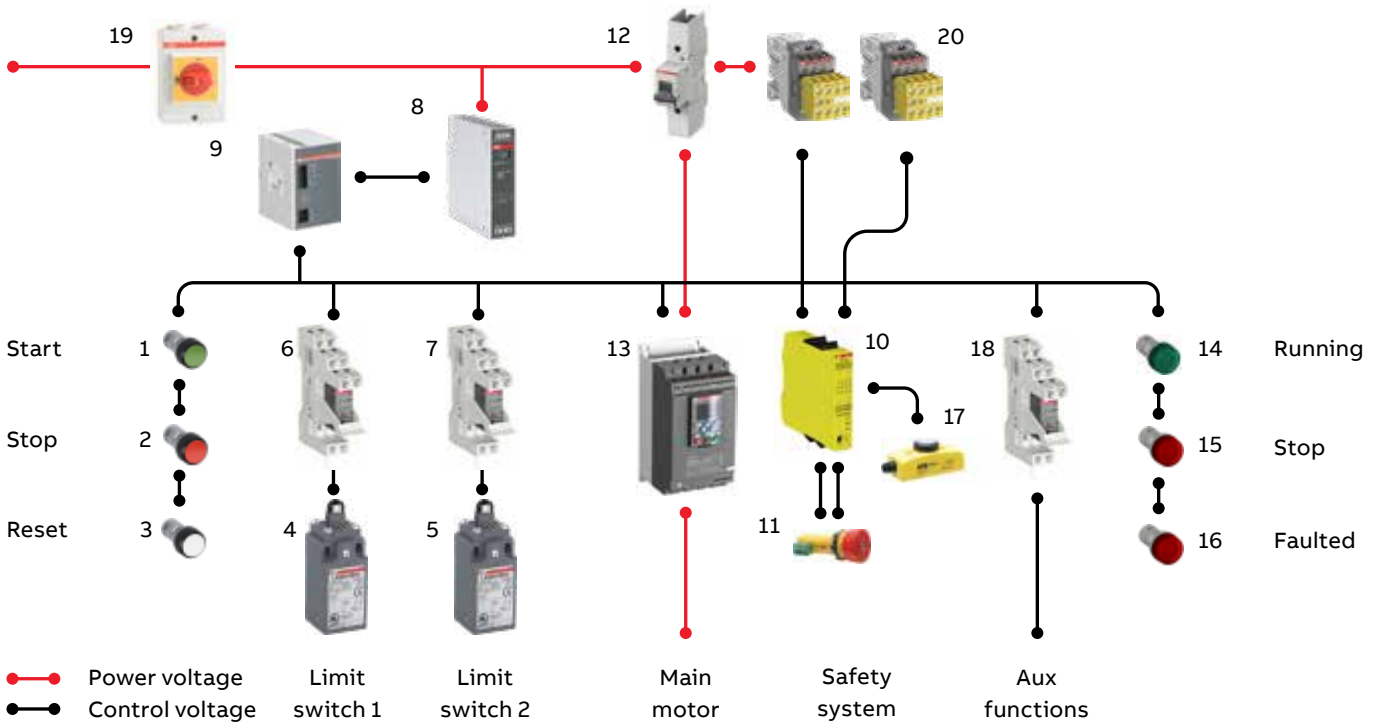

#	Order code	Description
1	1SFA619100R1012	Pushbutton CP1-10G-10
2	1SFA619100R1041	Pushbutton CP1-10R-01
3	1SFA619100R1015	Pushbutton CP1-10W-10
4	1SBV010510R1211	Limit switch 30 mm wide, 1 ISO M 16x1.5 cable entry on the bottom, plain plastic plunger actuator and 1 N.O. + 1 N.C. snap action (Zb type) contacts
5	1SBV010510R1211	Limit switch 30 mm wide, 1 ISO M 16x1.5 cable entry on the bottom, plain plastic plunger actuator and 1 N.O. + 1 N.C. snap action (Zb type) contacts
6	1SVR405600R1000	Pluggable interface relay CR-P024DC1 1c/o, A1-A2 = 24 V DC, 250 V/16 A with socket
7	1SVR405600R1000	Pluggable interface relay CR-P024DC1 1c/o, A1-A2 = 24 V DC, 250 V/16 A with socket
8	1SVR320661R1000	Power supply CP-S.1 24/10.0, In: 100-240 V AC, 100 - 250 V DC, Out: 24 V DC
9	1SVR427060R1000	Buffer module CP-B 24/10.0, 24 V DC / 10 A, energy storage 13.700 Ws
10	2TLA010050R0000	Sentry safety relay SSR10 24 V
11	2TLA030054R0100	Emergency stop INCA 1
12	2CCS861002R0064	High-performance miniature circuit breaker S801S-C6-R
13	1SFA898103R7000	Softstarter PSTX30-600-70
14	1SFA619403R5022	Pilot light CL2-502G 24 V AC/DC
15	1SFA619403R5021	Pilot light CL2-502R 24 V AC/DC
16	1SFA619403R5021	Pilot light CL2-502R 24 V AC/DC
17	2TLA030053R0000	Reset button Smile 11 RA
18	1SVR405600R1000	Pluggable interface relay CR-P024DC1 1 c/o, A1-A2 = 24 V DC, 250 V/16 A with socket
19	1SCA022399R6590	Safety switch OTP16KA3M
20	1SBL176082R3022	2x Contactor AFS16Z-30-22-30 24 V DC

^{*)} Disclaimer: This bill of material shows one possible combination of devices. It should not be used in real projects without taking technical and other guidelines into account. Please select the size of devices including power supplies according to the specific requirements of the application.

CP-S.1 power supplies

Application example food & beverage^{*)}

The term mixer refers to containers which are filled with liquids and / or solids and then rotate to mix the contents. Mixers are used extensively not only in the food and beverage sector but also in many other applications like chemicals and road construction. In many mixers, heating and/or cooling may also be required. Subjected to application requirements, mixer control systems are working independently or connected to PLCs /DCS. Safety and F&B standards are very important for mixers.

Application example: Mixers (motor power/starting: 3 kW / direct-online starter (DOL))

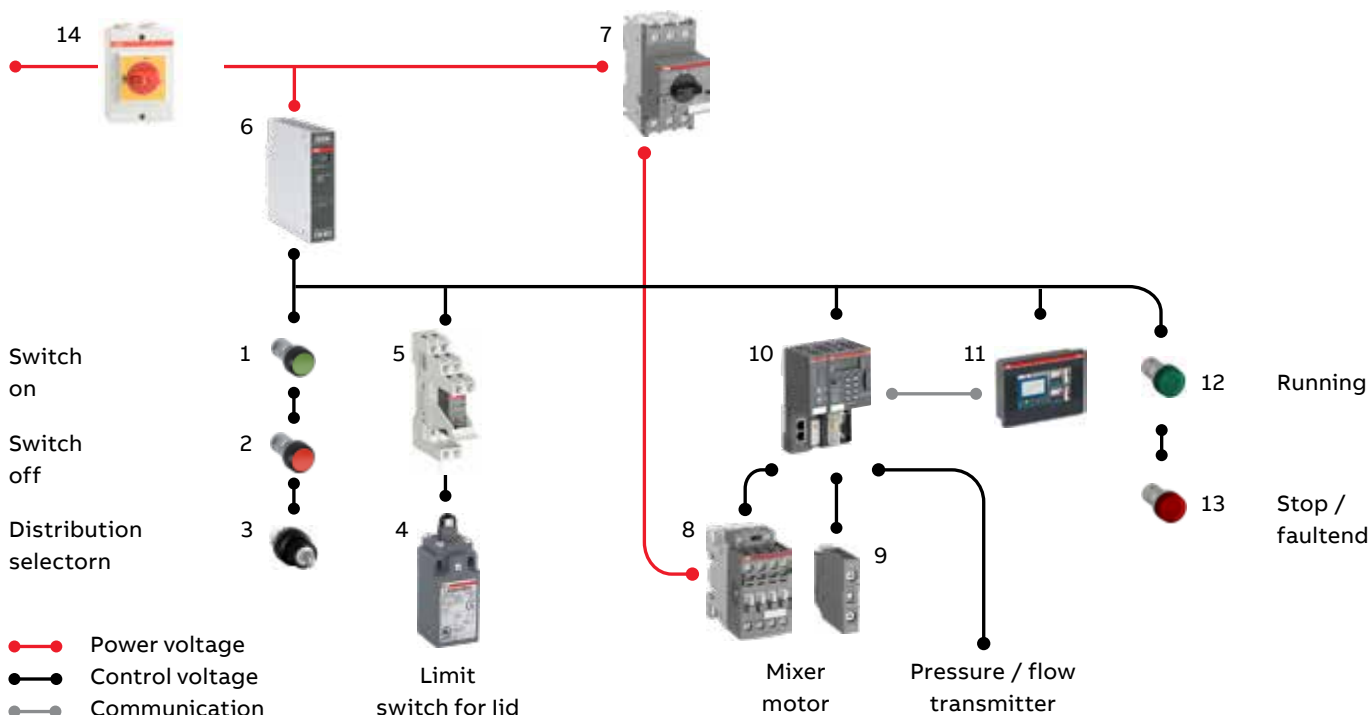

#	Order code	Description
1	1SFA619100R1012	Pushbutton CP1-10G-10
2	1SFA619100R1041	Pushbutton CP1-10R-01
3	1SFA611284R1001	Selector switch M3SSK2-101
4	1SBV010310R1211	30 mm wide, 1 ISO M16 x 1.5 cable entry on the bottom, plain plastic plunger actuator and 1 N.O + 1 N.C snap action (Zb type) contacts
5	1SVR405600R1000	Pluggable interface relay CR-P024DC1 1c/o, A1-A2=24 V DC, 250 V/16 A with socket
6	1SVR320361R1000	Power supply CP-S.1 24/10.0 In: 100-240 V AC Out: 24 V DC/10.0 A
7	1SAM350000R1010	Manual Motor Starter MS132-10
8	1SBL237001R1100	Contacteur AF26-30-00-11, 24-60 V 50/60 Hz 20-60 V DC
9	1SBN010110R1010	Auxiliary contact block CA4-10
10	1SAP111100R0270	Scalable PLC AC500, CPU PM592-ETH with PROFINET IO CM579-PNIO
11	1SAP504100R0001	CP604 Control Panel 4.3" TFT touch screen
12	1SFA619403R5022	Pilot light CL2-502G 24 V AC/DC
13	1SFA619403R5021	Pilot light CL2-502R 24 V AC/DC
14	1SCA022399R6590	Safety switch OTP16KA3M

^{*)} Disclaimer: This bill of material shows one possible combination of devices. It should not be used in real projects without taking technical and other guidelines into account. Please select the size of devices including power supplies according to the specific requirements of the application.

CP-S.1 power supplies

Ordering details



2CDC271001V0002L_CP-S1_3A

CP-S.1 24/3.0



2CDC271004V0002L_CP-S1_20A

CP-S.1 24/20.0



2CDC271001V0008

CP-C.1-A-RU

Description

ABB's new generation of CP-S.1 power supplies for machine building applications deliver high efficiency, high reliability and a minimized footprint. This advanced range of power supplies has an integrated 150 % power reserve functionality for up to 5 s and operate at an efficiency of up to 94 %. They come equipped with overheat protection and active power factor correction*, combined with a broad AC and DC input voltage range and extensive worldwide approvals. Make the all-new CP-S.1 power supplies your preferred choice for professional DC applications. UL listing as well as marine approvals complete the assortment offering.

CP-S.1 power supplies have a rated output voltage of 24 V DC that is adjustable via a front-face rotary potentiometer "OUTPUT Adjust". The power supplies are available with rated output currents of 3.0 A, 5.0 A, 10 A, 20 A and 40 A. The rated output power ranges from 72 - 960 W and the rated supply voltage range from 100-240 V AC / 100-250 V DC. The typical efficiency is up to 94 % with low power dissipation and low heating. CP-S.1 power supplies have free convection cooling (no forced cooling with ventilators) and operate at an ambient temperature range from -25...+60 °C without derating (+70 °C with derating). They feature an open-circuit and are overload and short-circuit stable as well as an integrated input fuse.

Additionally, true redundancy for critical applications can be achieved with the optional redundancy units CP-C.1-A-RU which is available as an accessory. One LED on the front of the power supplies indicates the status and a transistor DC OK - signalling output "13-14".

Ordering details

Description	Rated input voltage	Rated output voltage	Rated output current	Output power	Order code
CP-S.1 24/3.0	100-240 V AC, 100-250 V DC	24 V DC	3.0 A	72 W	1SVR320361R1000
CP-S.1 24/5.0			5.0 A	120 W	1SVR320561R1000
CP-S.1 24/10.0			10.0 A	240 W	1SVR320661R1000
CP-S.1 24/20.0			20.0 A	480 W	1SVR320761R1000
CP-S.1 24/40.0			40.0 A	960 W	1SVR320861R1000
CP-C.1-A-RU	10 - 56 V DC	12 - 48 V DC	2 x 20 A or 1 x 40 A	-	1SVR360060R1001

*) Not equipped with 72 W variant (3A).

*) Not equipped with 72 W variant (3A).

CP-S.1 power supplies

Technical data

Data at $T_a = 25\text{ °C}$ and rated values ($U_{in} = 230\text{ V AC}$), unless otherwise indicated

Type		CP-S.1 24/3.0	CP-S.1 24/5.0	CP-S.1 24/10.0	CP-S.1 24/20.0	CP-S.1 24/40.0	
Input circuit - Supply circuit (L(+), N(-))							
Rated input voltage U_{in}		100 - 240 V AC, 100 - 250 V DC				110 - 240 V AC, 110 - 250 V DC	
Input voltage range		85 - 264 V AC / 90 - 277 V DC				99 - 264 V AC / 99 - 277 V DC	
Input current range at rated output power	100 - 240 V AC	0.95 - 1.46 A	0.67 - 1.45 A	1.25 - 2.8 A	2.55 - 5.8 A	5.0 - 11.5 A	
	100 - 250 V DC	0.35 - 1.0 A	0.58 - 1.63 A	1.12 - 3.15 A	2.28 - 6.4 A	4.48 - 13.5 A	
Typical input current	at 115 V AC	1.52 A	1.24 A	2.45 A	4.85 A	9.5 A	
	at 230 V AC	0.95 A	0.67 A	1.25 A	2.55 A	5.0 A	
Max. power consumption	at 230 V AC	82 W	132 W	258 W	517 W	1,022 W	
Rated frequency		DC, 50 / 60 Hz					
Frequency range	AC	45 - 65 Hz					
Inrush current limiting, cold state		$\leq 11\text{ A}$	$\leq 11\text{ A}$	$\leq 11\text{ A}$	$\leq 12.8\text{ A}$	$\leq 19\text{ A}$	
Let-through energy I^2t , cold state	at 230 V AC	$< 1.5\text{ A}^2\text{s}$	$< 1.2\text{ A}^2\text{s}$	$< 1.7\text{ A}^2\text{s}$	$< 3\text{ A}^2\text{s}$	$< 5\text{ A}^2\text{s}$	
Discharge current towards PE		$< 3.5\text{ mA}$					
Hold-up time	at 115 V AC	$> 10\text{ ms}$	$> 20\text{ ms}$	$> 15\text{ ms}$	$> 15\text{ ms}$	$> 20\text{ ms}$	
	at 230 V AC	$> 20\text{ ms}$	$> 30\text{ ms}$	$> 20\text{ ms}$	$> 20\text{ ms}$	$> 20\text{ ms}$	
Internal input fuse		Yes					
Recommended backup fuse for wire protection at 1.5 mm^2		1 pole miniature circuit breaker ABB type S 200 (for USA/CAN: use appropriate branch circuit 20 A fuse acc. to regional and national regulation)					
	characteristic	B or C					
	max. rating	16 A					
Power Factor Correction (PFC)		no	yes, active				
Transient over-voltage protection		yes, varistor					
User interface - Indication of operational states							
Output voltage	LED 'OUTPUT OK'	Green	$\geq 92\%$ of adjusted U_{out}				
	LED 'OUTPUT OK'	Flash	$< 90\%$ of adjusted U_{out}				
Output circuits - power output (L+, L-)							
Rated output voltage		24 V DC					
Tolerance of the output voltage		$\pm 1\%$					
Adjustment range of the output voltage		24...28 V DC					
Rated output power		72 W	120 W	240 W	480 W	960 W	
Rated output current I_r	$-25\text{ °C} \leq T_a \leq 60\text{ °C}$	3 A	5 A	10 A	20 A	-	
	$-25\text{ °C} \leq T_a \leq 55\text{ °C}$	-	-	-	-	40 A	
Power reserve current	$-25\text{ °C} \leq T_a \leq 60\text{ °C}$	4.5 A (5 s)	7.5 A (5 s)	15 A (5 s)	30 A (5 s)	60 A (5 s) / $-25\text{ °C} \leq T_a \leq 55\text{ °C}$	
Short-circuit current limiting		$< 5.2\text{ A}$	$< 8.62\text{ A}$	$< 17.25\text{ A}$	$< 34.5\text{ A}$	$< 70\text{ A}$	
Derating of the output current	$60\text{ °C} \leq T_a \leq 70\text{ °C}$	2.5 % / K				-	
	$55\text{ °C} \leq T_a \leq 70\text{ °C}$	-				2 % / K	
Deviation width of output voltage	Load effect/ load regulation	static load change: 25 - 100 %	$< 1\%$	$< 1\%$	$< 1\%$	$< 1\%$	$< 1\%$
		Transient response of voltage to load current changes	dynamic load change: $< 3\%$	dynamic load change: $< 3\%$	dynamic load change: $< 3\%$	dynamic load change: $< 5\%$	dynamic load change: $< 3\%$
	Change of input voltage	recovery time T_R	$< 1\text{ ms}$	$< 1\text{ ms}$	$< 1\text{ ms}$	$< 1\text{ ms}$	$< 1\text{ ms}$
		within the rated input voltage	$< 0.5\%$	$< 0.5\%$	$< 0.5\%$	$< 0.5\%$	$< 0.5\%$
Starting time after applying the supply voltage		$< 1,500\text{ ms}$	$< 1,500\text{ ms}$	$< 1,500\text{ ms}$	$< 1,500\text{ ms}$	$< 1,500\text{ ms}$	
Residual ripple and switching peaks	BW = 20 MHz	$< 75\text{ mV}_{pp}$, class A					
Parallel connection		yes, up to 3					
Series connection		yes, 2					

CP-S.1 power supplies

Technical data

Type	CP-S.1 24/3.0	CP-S.1 24/5.0	CP-S.1 24/10.0	CP-S.1 24/20.0	CP-S.1 24/40.0	
No-load, overload and short-circuit behavior						
Characteristic curve of output	U/I characteristic curve			U/I characteristic curve combined with foldback behavior		
Short-circuit protection	continuous short-circuit stability					
Short-circuit behavior	current limiting					
Resistance to reverse feed	≤ 35 V DC					
Overvoltage protection	yes, < 35 V					
Overload protection	constant current limitation					
Overtemperature protection	protection by switch off in case of overtemperature (thermal)					
No-load protection	continuous no-load stability					
Starting of capacitive loads	Yes					
Signaling outputs - OUTPUT OK signaling output						
Type of output	13 - 14	relay, n/o contact				
ON (contact closed)		≥ 92 % of adjusted U _{out}				
OFF (contact open)		< 90 % of adjusted U _{out}				
Contact ratings	max. switching voltage / current	30 V AC - 0.5 A / 24 V DC - 1 A (resistive load)				
	min. switching voltage / current	5 V DC / 1 mA				
General data						
Efficiency	at rated load	> 89 %	> 90 %	> 93 %	> 93 %	> 94 %
Power losses	at rated load	< 10 W	< 12 W	< 18 W	< 37 W	< 62 W
	at 50 % of rated load	< 6.5 W	< 9.5 W	< 14 W	< 24 W	< 45 W
	at no load	< 2.8 W	< 3.5 W	< 5 W	< 6 W	< 6.5 W
Duty time		100 %				
MTBF	acc. to MIL 217 HDBK GB 25	on request				
Dimensions (W x H x D)		see dimensional drawings				
Material of housing	cover	zinc-coated sheet-steel				
	housing shell	aluminium				
	front	plastic, PC GE8B35, V0				
Mounting		DIN rail (IEC/EN 60715), snap-on mounting				
Mounting position		position 1 (standard orientation); other mounting positions possible with derating / deratings are available on demand				
Minimum distance to other units	horizontal	30 mm				
	vertical	50 mm				
Degree of protection (IEC/EN 60529)	housing / terminals	IP20 / IP20				
Protection class (IEC/EN 61140)		I				
Electrical connection						
Connecting capacity	rigid	0.5-2.5 mm ² (20-14 AWG)	0.5-4.0 mm ² (20-12 AWG)	0.5-4.0 mm ² (20-12 AWG)	0.5-4.0 mm ² (20-12 AWG)	0.5-10.0 mm ² (20-8 AWG)
	fine-strand with(out) wire end ferrule	0.5-2.5 mm ² (26-14 AWG)	0.5-4.0 mm ² (20-12 AWG)	0.5-4.0 mm ² (20-12 AWG)	0.5-4.0 mm ² (20-12 AWG)	0.5-10.0 mm ² (20-8 AWG)
Stripping length		9 mm	9 mm	9 mm	9 mm	10 mm
Tightening torque		0.5 Nm 4.43 lb.in	0.5 Nm 4.43 lb.in	0.5 Nm 4.43 lb.in	0.5 Nm 4.43 lb.in	1.47 Nm 13.0 lb.in
Recommended screw driver		PH0 / Ø 3.5 x 0.6 mm	PH1 / Ø 4.0 x 0.8 mm	PH1 / Ø 4.0 x 0.8 mm	PH1 / Ø 4.0 x 0.8 mm	PH2 / Ø 5.5 x 1.0 mm

CP-S.1 power supplies

Technical data

Type	CP-S.1 24/3.0	CP-S.1 24/5.0	CP-S.1 24/10.0	CP-S.1 24/20.0	CP-S.1 24/40.0
Output circuits (L+, L+, L-, L-)					
Stripping length	9 mm	9 mm	9 mm	9 mm	10 mm
Tightening torque	0.5 Nm 4.43 lb.in	1.13 Nm 10 lb.in	1.13 Nm 10 lb.in	1.13 Nm 10 lb.in	1.47 Nm 13.0 lb.in
Recommended screw driver	PH0 / Ø 3.5 x 0.6 mm	PH1 / Ø 4.0 x 0.8 mm	PH1 / Ø 4.0 x 0.8 mm	PH1 / Ø 4.0 x 0.8 mm	PH2 / Ø 5.5 x 1.0 mm
Signalling output (13-14)					
Connecting capacity	rigid	0.15 - 0.8 mm ² (26 - 18 AWG)			
	fine-strand with(out) wire end ferrule	0.15 - 0.8 mm ² (26 - 18 AWG)			
Stripping length	7 mm				
Connection terminals	push-in				
Environmental data					
Ambient temperature range	operation	-25...+70 °C (-13... +158 °F)			
	rated output power	-25...+60 °C (-13... +140 °F)			-25...+55 °C (-13... +131 °F)
	storage	-40...+85 °C (-40... +185 °F)			
	transportation	-40...+85 °C (-40... +185 °F)			
Climatic class (IEC/EN 60721-3-1)	storage	1K2			
Climatic class (IEC/EN 60721-3-2)	transportation	2K2			
Climatic class (IEC/EN 60721-3-3)	operation	3K3			
Damp heat, cyclic (IEC/EN 60068-2-30)	test Db: 55 °C, 2 cycles				
Vibration (IEC/EN 60068-2-6)	test Fc: 10-58 Hz, amplitude ±0.15 mm, 58-150 Hz, 2 g, 10 sweep cycles each axis				
Shock, half-sine (IEC/EN 60068-2-27)	test Ea: 30 g, 6 ms, 3 pulses each axis; bump 20 g, 11 ms, 100 pulses each axis				
Location classes (according DNV)	temperature: B / humidity: B / vibration: A / enclosure: A				
Coated PCBA	yes				
Isolation data					
Rated impulse withstand voltage U _{imp} (IEC/EN 62477-1)	input circuit / output circuit	4 kV (1.2/50 µs)			
	input circuit / PE	4 kV (1.2/50 µs)			
	input circuit / relay contact	4 kV (1.2/50 µs)			
	output circuit / relay contact	0.8 kV (1.2/50 µs)			
	relay contact / PE	0.8 kV (1.2/50 µs)			
	output circuit / PE	0.8 kV (1.2/50 µs)			
Rated insulation voltage U _i (IEC/EN 62477-1)	input circuit / output circuit	300 V			
	input circuit / PE	300 V			
	input circuit / relay contact	300 V			
	output circuit / relay contact	50 V			
	relay contact / PE	50 V			
	output circuit / PE	50 V			
Overvoltage category (IEC/EN 62477-1)	< 2000 m	III			
	2000...5000 m	II			
Overvoltage category (IEC/EN 61010-1/IEC/ EN 61010-2-201)	< 2000 m	II			
	2000 ...5000 m	II			
Pollution degree	2				
Protective separation IEC/EN 61010-1, 61010-2-201	input circuit / output circuit	yes			
	input circuit / relay output	yes			

CP-S.1 power supplies

Technical data

Type	CP-S.1 24/3.0	CP-S.1 24/5.0	CP-S.1 24/10.0	CP-S.1 24/20.0	CP-S.1 24/40.0
Standards / Directives					
Low Voltage Directive	2014/35/EU, IEC/EN 61204				
EMC directive	2014/30/EU				
RoHS directive	2011/65/EU incl. 2015/863/EU				
WEEE directive	2012/19/EU				
Electrical safety	IEC/EN 61010-1. IEC/EN 61010-2-201				
Process control equipment	UL 61010-1, UL 61010-2-201/ CAN/CSA C22.2 No. 61010-1-12, CAN/CSA-IEC 61010-2-201:18				
Protective extra low voltage	PELV_IEC/EN 61010-2-201				
Safety extra low voltage	SELV_IEC/EN 61010-2-201				
Limitation of harmonic line currents	IEC/EN 61010-2-201				
Electromagnetic compatibility					
Low-voltage power supplies, d.c. output – Part 3: Electromagnetic compatibility (EMC)	IEC/EN 61204-3				
Interference immunity to	IEC/EN 61000-6-2				
electrostatic discharge (ESD)	IEC/EN 61000-4-2	contact discharge air discharge, level 4, 8 kV / 15 kV (criterion A)			
radiated, radio-frequency, electromagnetic field	IEC/EN 61000-4-3	80 to 1000 MHz, 10 V/m (criterion A), 1.4 to 6 GHz, 3 V/m (criterion A)			
electrical fast transient / burst	IEC/EN 61000-4-4	level 4, 4 kV / 2 kV (criterion A)			
surge	IEC/EN 61000-4-5	level 4, L/N 3 kV (criterion A); level 4, L, N / PE 4 kV (criterion A)			
conducted disturbances, induced by radio-frequency fields	IEC/EN 61000-4-6	level 3, 10 V (criterion A)			
voltage dips, short interruptions and voltage variations	IEC/EN 61000-4-11	class 3			
harmonics and interharmonics	IEC/EN 61000-4-13	class 3 (criterion A)			
conducted, common mode disturbances in the frequency range 0 Hz to 150 kHz	IEC/EN 61000-4-1	level 3, 10 V			
Interference emission	IEC/EN 61000-6-3; IEC/EN 61000-6-4				
limits for harmonic current emissions	IEC/EN 61000-3-2	class A			
limitation of voltage changes etc.	IEC/EN 61000-3-3	compliant			
Electromagnetic compatibility of multimedia equipment - Emission requirements	IEC/CISPR 32, EN 55032	class B			
industrial scientific and medical (ISM) radio-frequency equipment electromagnetic disturbance characteristics limits and methods of measurement	EC/CISPR 11, EN 55011 EN 50204	class B			
Voltage sags	SEMI F47-0706	passed			
Federal Communications Commission	FCC15	compliant			
EMC according DNV	DNV-CG-0339	all locations including bridge and open deck class B			
Weight	550 g	690 g	830 g	1.355 g	2.490 g

CP-S.1 power supplies

Technical diagrams

Wiring instructions

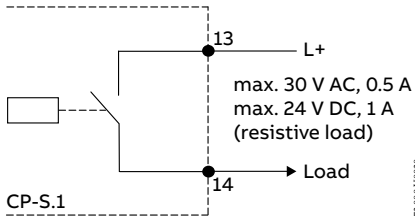

OUTPUT OK, relay output
 Rated voltage limits of the signaling output relay:
 Acc. UL 61010-1: 30 V RMS, 42.4 V peak, 60 V DC

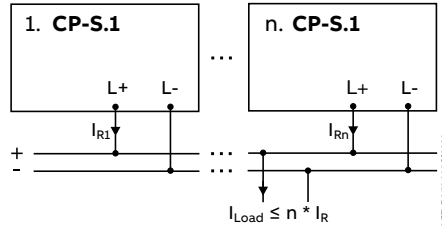

Parallel operation, increased power ($n \leq 3$)

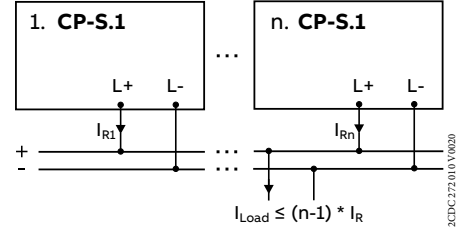

Parallel operation, redundancy ($n \leq 3$)

U/I characteristic curves of output at $T_a = 25^\circ\text{C}$

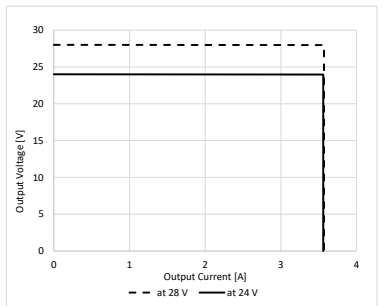

CP-S.1 24/3.0

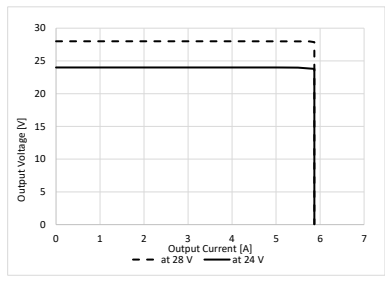

CP-S.1 24/5.0

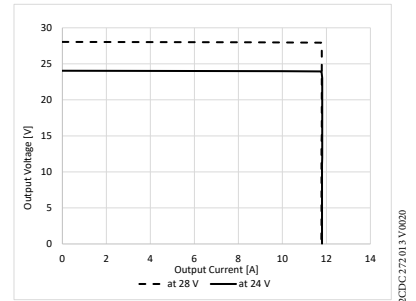

CP-S.1 24/10.0

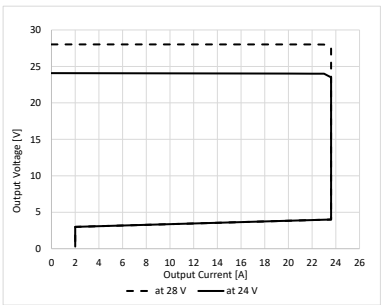

CP-S.1 24/20.0

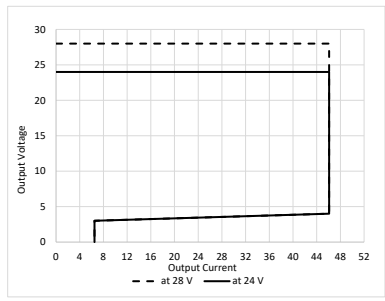

CP-S.1 24/40.0

CP-S.1 power supplies

Technical diagrams

Mounting and dismounting

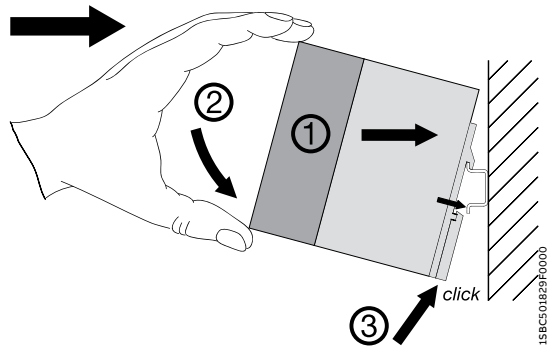

Mounting

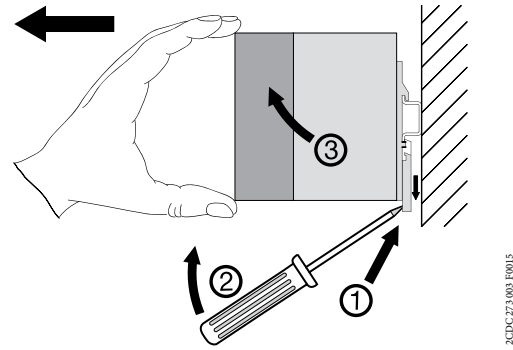

Dismounting

Characteristic curves of temperature $U_{out} = 24\text{ V DC}$

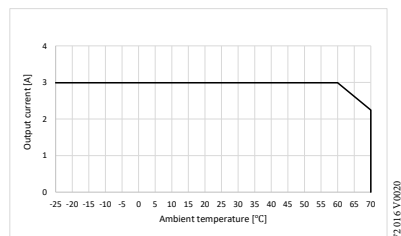

CP-S.1 24/3.0

2CDC272016 V0020

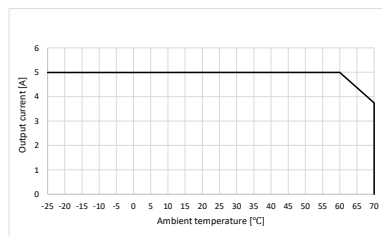

CP-S.1 24/5.0

2CDC272017 V0020

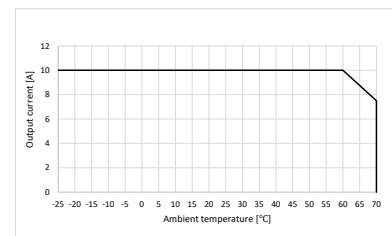

CP-S.1 24/10.0

2CDC272018 V0020

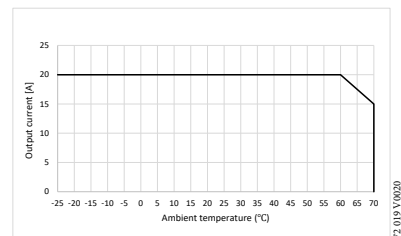

CP-S.1 24/20.0

2CDC272019 V0020

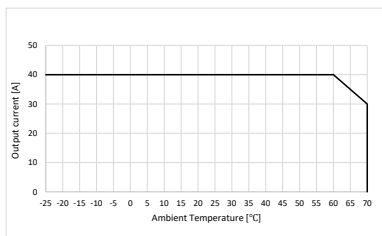

CP-S.1 24/40.0

2CDC272020 V0020

CP-S.1 power supplies

Technical diagrams

Dimensional drawings

in mm and inches

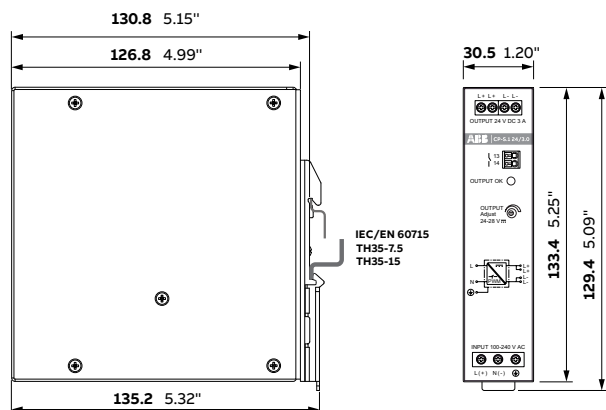

CP-S.124/3.0

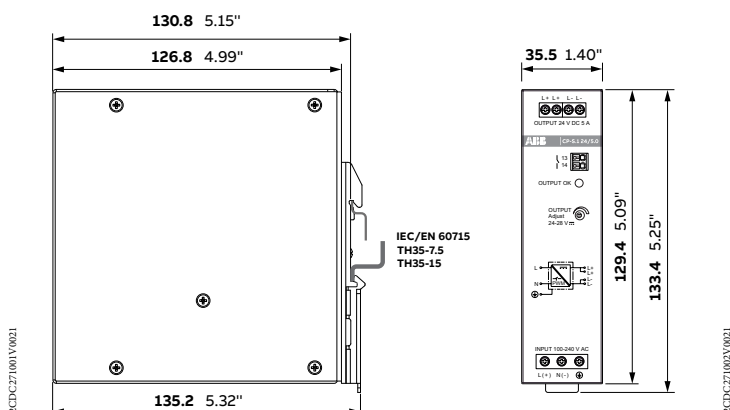

CP-S.124/5.0

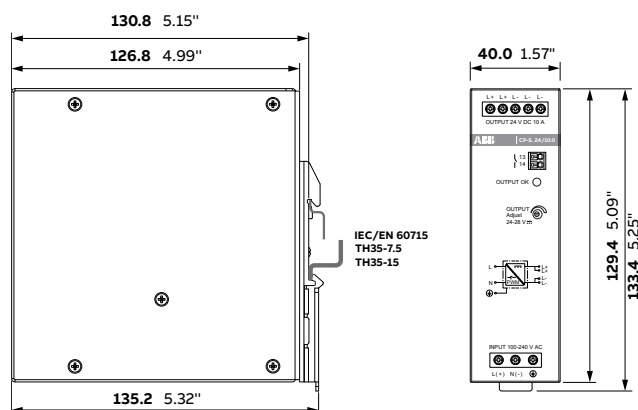

CP-S.124/10.0

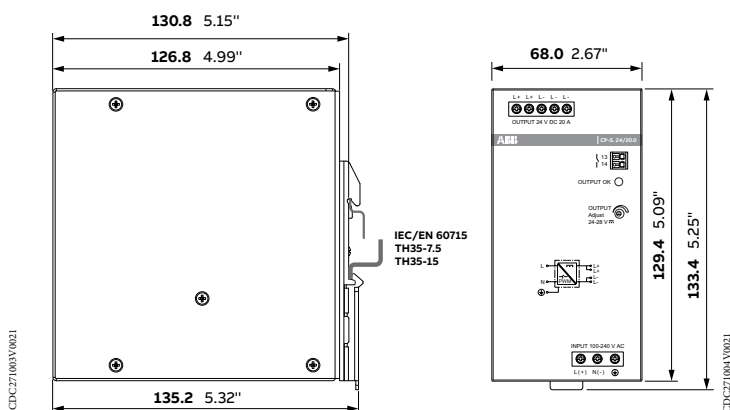

CP-S.124/20.0

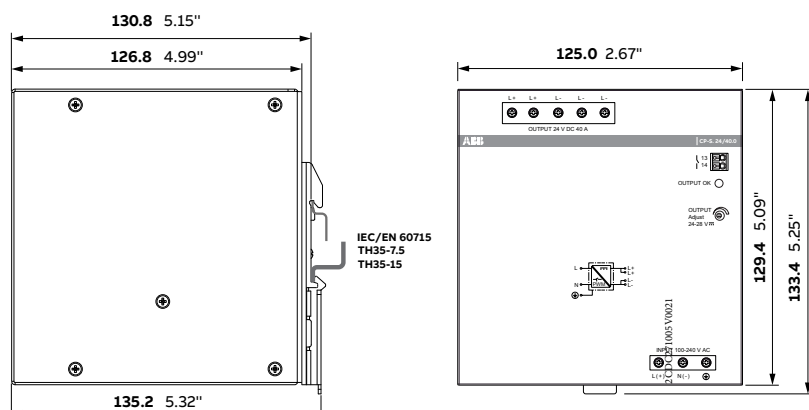

CP-S.124/40.0



CP-C.1 range

Table of contents

330	Benefits and advantages
332	Operating controls
333	Applications
334	Ordering details
335	Technical data
347	Technical diagrams

CP-C.1 range

Benefits and advantages



The high-performance CP-C.1 power supplies are ABB's most advanced range. With excellent efficiency, high reliability and innovative functionality, it is ready to take on the most demanding of industrial applications. These power supplies have a 150 % integrated power reserve, operate at an efficiency of up to 94 % and are equipped with overheat protection and active power factor correction. Combined with a broad AC and DC input range and extensive worldwide approvals, CP-C.1 power supplies are the preferred choice for professional DC applications. ATEX and IECEx approvals are available for the use in hazardous areas.



Continuous operation

- Power reserve design to allow performance with up to 150 % more current
- Redundancy setup of the application possible to allow parallel operation
- Long lifetime
- High peak currents for switching on capacitive loads are supported



Project cost reduction

- Up to 94 % efficiency saves money for energy during operation
- Less need for external cooling in the cabinet
- Small size to reduce space needed in panel



Reliable in harsh conditions

- Extended ambient temperature range during operation -40...+70 °C with coated PCBA version
- IECEx/ATEX approvals for hazardous locations available
- High MTBF values

CP-C.1 range

Benefits and advantages



Characteristics

- Rated output voltage 24 V DC
- Power reserve design delivers up to 150 % at $T_a \leq 40 \text{ }^\circ\text{C}$
- Output voltage adjustable via front-facing rotary potentiometer "OUTPUT Adjust", 22.5-28.5 V
- High efficiency of up to 94 %
- Low power dissipation and low heating
- Free convection cooling (no forced cooling)
- Devices with coated PCBAs for harsh environments and with extended temperature range
- Open-circuit, overload and short-circuit stable
- Integrated input fuse
- OUTPUT OK - signaling output "13-14" (relay), Power reserve signaling output " $I > I_r$ " (transistor)
- Redundancy unit offers true redundancy, available as accessory
- Various approvals and marks



Main benefits

The primary switch mode power supply CP-C.1 has a wide range of certified AC and DC input voltages. Furthermore, the CP-C.1 is equipped with capacitors that ensure a hold-up time of at least 50 ms. This enables worldwide usage and permits safe operation in fluctuating networks and battery-powered applications.

With their robust metallic housing and the reliable construction, CP-C.1 power supplies are suitable for applications in industrial environments. The CP-C.1-C units have coated PCBAs, which enables their use in harsh industrial environments. The power reserve of up to 150 % enables trouble-free starting of heavy loads eliminating the need for an oversized power supply.

Signaling output

To communicate the status of the power supply, the CP-C.1 is equipped with a relay output to signal OUTPUT OK as well as a transistor output $I > I_r$ to indicate when the power reserve is active. These signals can be used for communication with a higher level control system, e.g. a PLC.

Depending on the logic of the higher level control system, an appropriate action is initiated by forwarding the signal. The receptor of this signal could be a contactor, a signal tower, or an interface relay.

CP-C.1 range

Operating controls

13-14: Relay output to signal 'Output OK'

$I > I_R$: Power reserve transistor output to signal 'Power reserve is active'

OUTPUT L+, L-: Output terminals 24 V DC

Indication of operational states
OUTPUT OK: Green LED
POWER RESERVE $I > I_R$: Yellow LED

Side mounting screw holes for DIN rail adapter / lateral mounting

OUTPUT Adjust: Rotary potentiometer - Adjustment of output voltage 22.5-28.5 V DC

Circuit diagram

INPUT L(+), N(-), PE: Input terminals 85-264 V AC / 90 - 300 V DC

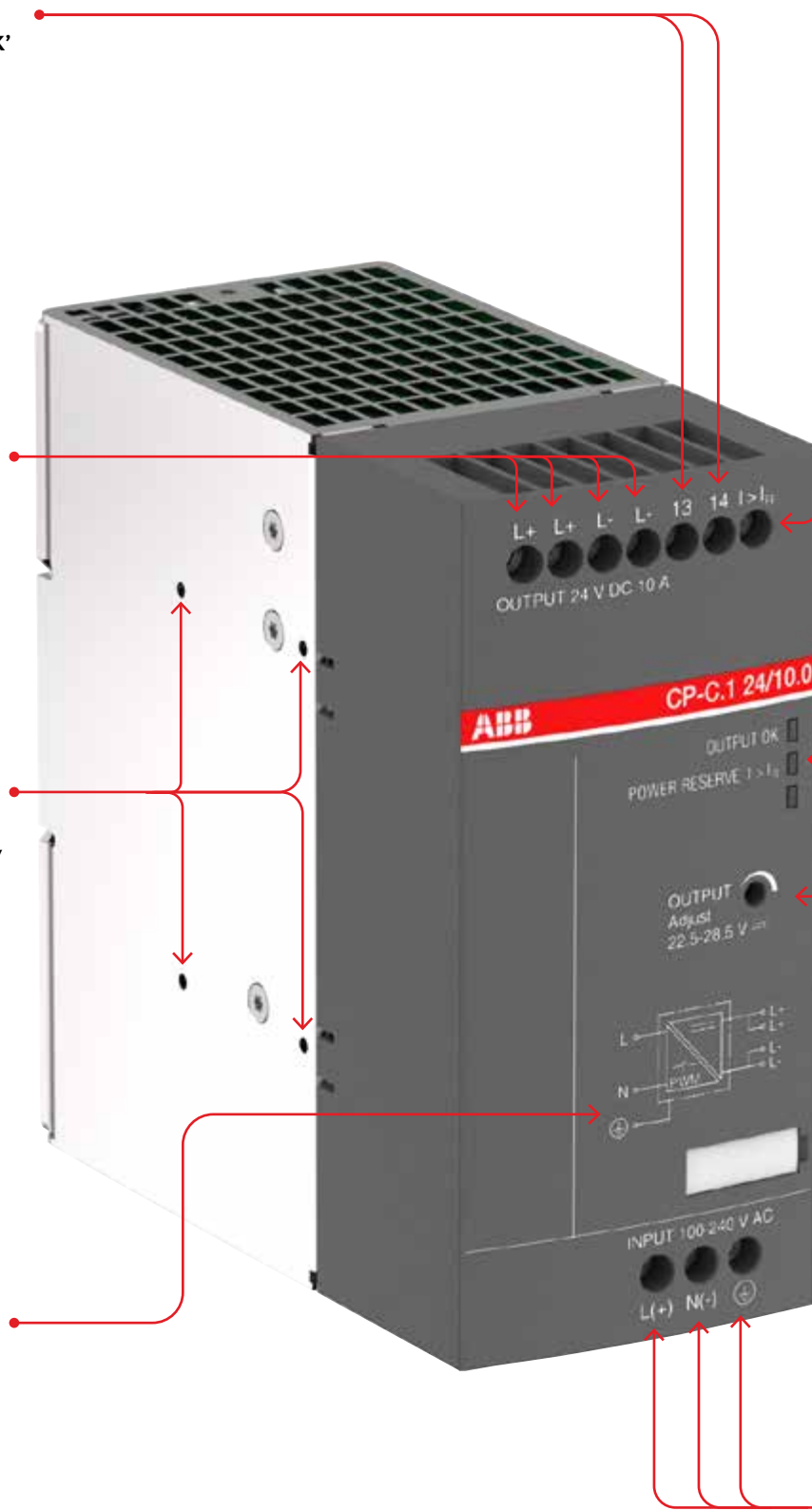

CP-C.1 range

Applications



Application

The primary switch mode power supply CP-C.1 has a wide range of AC and DC input voltages. Furthermore, the CP-C.1 is equipped with capacitors that ensure a hold-up time of at least 50 ms. This enables worldwide usage and permits safe operation in fluctuating networks and battery-powered applications. With their robust metallic housing and reliable construction, CP-C.1 power supplies are suitable for applications in industrial environments. The CP-C.1-C units have coated PCBAs, which enables their use in the harshest of industrial environments. usage in even harsh industrial environments. The power reserve of up to 150 % enables trouble-free starting of heavy loads eliminating the need for an oversized power supply.



Adjustable output voltage

The CP-C.1 range power supplies feature a continuously adjustable output voltage of 22.5 to 28.5 V DC. Thus, they can be optimally adapted to the applications, e.g. compensating the voltage drop caused by a long line length.



Signaling output

To communicate the status of the power supply, the CP-C.1 is equipped with a relay output to signal OUTPUT OK as well as a transistor output $I > I_R$ to indicate when the power reserve is active. These signals can be used for communication with a higher level control system, e.g. a PLC.



Power reserve

The primary switch mode power supply CP-C.1 is equipped with a power reserve functionality to handle the start-up of particularly heavy loads (e.g. of a capacitive load or a motor). To ensure that heavy loads are started up, the CP-C.1 delivers additionally up to 150 % of the rated output current to secure the operation of the application. This status is displayed by the yellow LED labelled POWER RESERVE $I > I_R$.

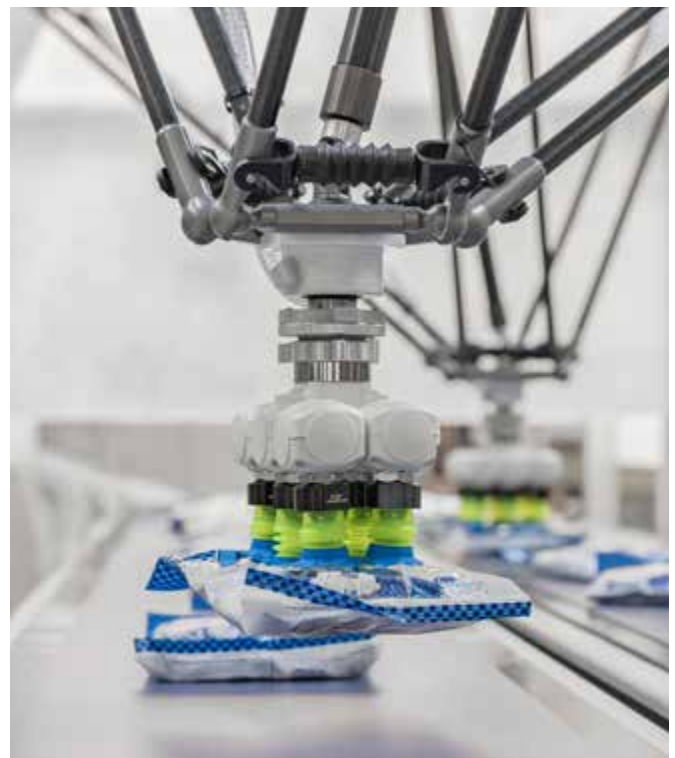

CP-C.1 range

Ordering details



2CDC271009 F007

CP-C.1 24/5.0
CP-C.1 24/5.0-C



2CDC271010 V007

CP-C.1 24/10.0
CP-C.1 24/10.0-C



2CDC271011 V007

CP-C.1 24/20.0
CP-C.1 24/20.0-C



CP-C.1 24/5.0-L



CP-C.1 24/10.0-L

Description

High-performance CP-C.1 power supplies are ABB's most advanced range. With excellent efficiency, high reliability, and innovative functionality, it is ready to take on the most demanding industrial applications. These power supplies have up to 50 % integrated power reserve and operate at an efficiency of up to 94 %. They are equipped with overheat protection and active power factor correction. Combined with a broad AC and DC input range and extensive worldwide approvals, the CP-C.1 power supplies are the preferred choice for professional DC applications.

Ordering details - CP-C.1

Input voltage range	Rated output voltage / current	PCBA	Color	Type	Order code	Weight (1 pc.) kg (lb)
85-264 V AC, 90-300 V DC	24 V DC / 5 A	uncoated	dark grey	CP-C.1 24/5.0	1SVR360563R1001	0.87 (1.92)
	24 V DC / 10 A			CP-C.1 24/10.0	1SVR360663R1001	1.21 (2.67)
	24 V DC / 20 A			CP-C.1 24/20.0	1SVR360763R1001	1.70 (3.75)
	24 V DC / 5 A	coated		CP-C.1 24/5.0-C	1SVR360563R2001	0.87 (1.92)
	24 V DC / 10 A			CP-C.1 24/10.0-C	1SVR360663R2001	1.24 (2.73)
	24 V DC / 20 A			CP-C.1 24/20.0-C	1SVR360763R2001	1.72 (3.79)
85-264 V AC, 90-300 V DC	24 V DC / 5 A	uncoated	light grey	CP-C.1 24/5.0-L	1SVR361563R1001	0.87 (1.92)
	24 V DC / 10 A			CP-C.1 24/10.0-L	1SVR361663R1001	1.21 (2.67)
	24 V DC / 20 A			CP-C.1 24/20.0-L	1SVR361763R1001	1.70 (3.75)

CP-C.1 range

Technical data

Data at $T_a = 25\text{ °C}$, $U_{in} = 230\text{ V AC}$ and rated values, unless otherwise indicated

Type	CP-C.1 24/5.0, CP-C.1 24/5.0-L		CP-C.1 24/5.0-C
Input circuit - Supply circuit			
		L (+), N (-)	
Rated input voltage U_{in}		100-240 V AC, 100-270 V DC	
Input voltage range		85-264 V AC, 90-300 V DC	
Input current range at rated output power	100-240 V AC	0.6-1.4 A	
	100-270 V DC	0.5-1.6 A	
Typical input current	at 115 V AC	1.1 A	
	at 230 V AC	0.6 A	
Typical power consumption	at 230 V AC	132 W	
Rated frequency		DC, 50/60 Hz	
Frequency range	AC	45-65 Hz	
Inrush current, cold state		< 8 A	
Let-through energy I^2t , cold state	at 230 V AC	< 1 A ² s	
Discharge current towards PE		< 3.5 mA	
Hold-up time	at 115 V AC	min. 50 ms	
	at 230 V AC	min. 50 ms	
Internal input fuse		T4.0 A, not exchangeable	
Recommended backup fuse for wire protection at 1.5 mm ²		1 pole miniature circuit breaker ABB type S 200 For USA/CAN: Use appropriate branch circuit 20 A fuse acc. regional and national regulations.	
	characteristic	B or C	
	max. rating	16 A	
Power factor correction (PFC)		yes, active	
Transient overvoltage protection		yes, varistor	
User interface			
Indication of operational states			
Output voltage	LED 'OUTPUT OK' (green)	ON	≥ 92 % of adjusted U_{out}
		flashing	< 90 % of adjusted U_{out}
Power reserve	LED 'I > I _R ' (yellow)	OFF	$I \leq I_R$
		ON	$I > I_R$
Output circuit - Power output			
		L+, L-	
Rated output voltage		24 V DC	
Tolerance of the output voltage		± 1 %	
Adjustment range of the output voltage		22.5-28.5 V DC	
Rated output power		120 W	
Rated output current I_R	- 25 °C ≤ T_a ≤ 60 °C	5.0 A	-
	- 40 °C ≤ T_a ≤ 60 °C	-	5.0 A
Reserve output current	- 25 °C ≤ T_a ≤ 40 °C	7.5 A continuously	-
	- 40 °C ≤ T_a ≤ 40 °C	-	7.5 A continuously
Short-circuit current limiting		7.6 A	
Derating of the output current	60 °C < T_a ≤ 70 °C	2.5 %/°C	
Deviation width of output voltage	static output voltage deviation 25-100 %	< 1 %	
		dynamical 0-100 %	
	change of input voltage within the rated input voltage	< 0.1 %	
Recovery time T_A		< 1 ms	
Starting time after applying the supply voltage		< 500 ms	
Residual ripple and switching peaks	BW = 20 MHz	< 120 mV _{pp} , class A	
Parallel connection		yes, up to 5 devices, to enable redundancy and to increase power, current not symmetrical	
Series connection		yes, max. 2 devices to increase voltage	

CP-C.1 range

Technical data

Type	CP-C.1 24/5.0, CP-C.1 24/5.0-L	CP-C.1 24/5.0-C
No-load, overload and short-circuit behavior		
Characteristic curve of output	U/I characteristic curve with power reserve	
Short-circuit protection	continuous short-circuit stability	
Short-circuit behavior	current limiting	
Resistance to reverse feed	≤ 35 V DC	
Overload protection	constant current limitation	
Overtemperature protection	protection by switch off in case of overtemperature (thermal protection), automatic restart	
No-load protection	continuous no-load stability	
Starting of capacitive loads	yes	
Signaling outputs		
OUTPUT OK signaling output		
Type of output	13-14	relay, n/o contact
ON (contact closed)		≥ 92 % of adjusted U_{out}
OFF (contact open)		< 90 % of adjusted U_{out}
Contact ratings	max. switching voltage / current	30 V AC - 0.5 A / 24 V DC - 1 A (resistive load)
	min. switching voltage / current	5 V DC / 1 mA
POWER RESERVE signaling output		
Type of output	$I > I_R$	transistor, short-circuit proof
Active / ON (closed)		$I > I_R$
Inactive / OFF (open)		$I \leq I_R$
Ratings	voltage/current	24 V DC / ≤ 20 mA
General data		
Efficiency	at rated output power	up to 93 %
Power loss	at rated output power	12 W
	at 50% of rated output power	8 W
	at no load	< 3.6 W
Duty cycle		100 %
MTBF	acc. to MIL 217 HDBK	on request
Dimensions		see "Dimensional drawings"
Material of housing	cover	zinc-coated sheet-steel
	housing shell	aluminium
	front	plastic, PA6, V-0
Mounting		DIN rail (IEC/EN 60715), snap-on mounting
Mounting position		see "Mounting positions" in the data sheet
Minimum distance to other units	horizontal	25 mm (0.98 in)
	vertical	25 mm (0.98 in)
Degree of protection (IEC/EN 60529)	housing / terminals	IP20 / IP20
Protection class (IEC/EN 61140)		I
Electrical connection		
Input circuits (L(+), N(-), PE)		
Connecting capacity	rigid	0.5-4.0 mm ² (20-10 AWG)
	fine-strand with(out) wire end ferrule	0.5-2.5 mm ² (20-12 AWG)
Stripping length		8 mm (0.315 in)
Tightening torque		0.5 Nm (4.4 lb.in)
Recommended screw driver		PH1 / Ø 4.0 x 0.8 mm
Output circuits (L+, L+, L-, L-)		
Connecting capacity	rigid	0.5-4.0 mm ² (20-10 AWG)
	fine-strand with(out) wire end ferrule	0.5-2.5 mm ² (20-12 AWG)
Stripping length		8 mm (0.315 in)
Tightening torque		0.5 Nm (4.4 lb.in)
Recommended screw driver		PH1 / Ø 4.0 x 0.8 mm

CP-C.1 range

Technical data

Type		CP-C.1 24/5.0, CP-C.1 24/5.0-L	CP-C.1 24/5.0-C
Signaling output (13-14, I > IR)			
Connecting capacity	rigid	0.5-4.0 mm ² (20-10 AWG)	
	fine-strand with(out) wire end ferrule	0.5-2.5 mm ² (20-12 AWG)	
Stripping length		8 mm (0.315 in)	
Tightening torque		0.5 Nm (4.4 lb.in)	
Recommended screw driver		PH1 / Ø 4.0 x 0.8 mm	
Maximum cable length (applicable for I>IR)		30 m	
Environmental data			
Ambient temperature range	operation	-25...+70 °C (-13... +158 °F)	-40...+70 °C (-40...+158 °F)
	rated output power	-25...+60 °C (-13... +140 °F)	-40...+60 °C (-40...+140 °F)
	storage	-40...+85 °C (-40...+185 °F)	
	transportation	-40...+85 °C (-40...+185 °F)	
Climatic class (IEC/EN 60721-3-1)	storage	1K2	
Climatic class (IEC/EN 60721-3-2)	transportation	2K2	
Climatic class (IEC/EN 60721-3-3)	operation	3K3	
Damp heat, cyclic (IEC/EN 60068-2-30)		test Db: 55 °C, 2 cycles	
Vibration (IEC/EN 60068-2-6)		test Fc: 10-58 Hz, amplitude ±0.15 mm, 58-150 Hz, 2 g, 10 sweep cycles each axis	
Shock, half-sine (IEC/EN 60068-2-27)		test Ea: 30 g, 6 ms, 3 pulses each axis; bump 20 g, 11 ms, 100 pulses each axis	
Coated PCBA		no	yes
Gaseous corrosive environment withstand test (IEC/EN 60068-2-60)		-	testing method: 4 testing period: 21 days ambient conditions: 25 °C, 75 % r.h. air/volume change rate per hour: 3-6 sample not energized during exposure gas concentrations acc. ISA-S71.04.2013 Harsh Group A, G3 IEC 60721-3.3 acc. 3C2/3C3 - H ₂ S ≥ 100 ± 10 ppb - SO ₂ /SO ₃ ≥ 300 ± 20 ppb - Cl ₂ ≥ 100 ± 10 ppb - NO _x ≥ 1250 ± 20 ppb
Isolation data			
Rated impulse withstand voltage U _{imp} (EN62477-1)	input circuit / output circuit	4 kV (1.2/50 μs)	
	input circuit / PE	4 kV (1.2/50 μs)	
	input circuit / relay contact	4 kV (1.2/50 μs)	
	output circuit / relay contact	0.5 kV (1.2/50 μs)	
	relay contact / PE	0.5 kV (1.2/50 μs)	
	output circuit / PE	0.5 kV (1.2/50 μs)	
	System voltage (EN 62477-1)	input circuit / output circuit	300 V
input circuit / PE		300 V	
input circuit / relay contact		300 V	
output circuit / relay contact		50 V	
relay contact / PE		50 V	
output circuit / PE		50 V	
Overvoltage category (IEC/EN 62477-1)	< 2000 m	III	
	2000...5000 m	II	
Overvoltage category (IEC/EN 61010-1)	< 2000 m	II	
Pollution degree		2	
Protective separation (IEC/EN 61010-1, 61010-2-201 and IEC60950-1)	input circuit / output circuit	yes	
	input circuit / relay contact	yes	

CP-C.1 range

Technical data

Type	CP-C.1 24/5.0, CP-C.1 24/5.0-L CP-C.1 24/5.0-C	
Standards / Directives		
Standards	IEC/EN 61204	
Low Voltage Directive	2014/35/EU	
EMC Directive	2014/30/EU	
ATEX Directive	-	2014/34/EU
RoHS Directive	2011/65/EU	
Electrical safety	IEC/EN 61010-1, IEC/EN 61010-2-201 and IEC/EN 60950-1	
Process control equipment	UL 61010-1, UL 61010-2-201 / CAN/CSA C22.2 No. 61010-1-12, CAN/CSA-IEC 61010-2-201:18	
Protective extra low voltage	PELV (IEC/EN 61010-2-201)	
Safety extra low voltage	SELV (IEC/EN 61010-2-201, IEC60950-1)	
Limitation of harmonic line currents	IEC/EN 61000-3-2	
Electromagnetic compatibility		
Low-voltage power supplies, d.c. output – Part 3: Electromagnetic compatibility (EMC)	IEC/EN 61204-3	
Interference immunity to	IEC/EN 61000-6-2	
electrostatic discharge (ESD)	IEC/EN 61000-4-2	level 4, 8 kV / 15 kV (criterion A)
radiated, radio-frequency, electromagnetic field	IEC/EN 61000-4-3	level 3, 10 V/m (criterion A)
electrical fast transient / burst	IEC/EN 61000-4-4	level 4, 4 kV / 2 kV (criterion A)
surge	IEC/EN 61000-4-5	level 4, L/N 2 kV (criterion A) level 4, L,N/PE 4 kV (criterion A)
conducted disturbances, induced by radio-frequency fields	IEC/EN 61000-4-6	level 3, 10 V (criterion A)
voltage dips, short interruptions and voltage variations	IEC/EN 61000-4-11	class 3
harmonics and interharmonics	IEC/EN 61000-4-13	class 3 (criterion A)
conducted, common mode disturbances in the frequency range 0 Hz to 150 kHz	IEC/EN 61000-4-16	level 3, 10 V
Interference emission	IEC/EN 61000-6-3	
limits for harmonic current emissions	IEC/EN 61000-3-2	class A
limitation of voltage changes etc.	IEC/EN 61000-3-3	compliant
Electromagnetic compatibility of multimedia equipment - Emission requirements	IEC/CISPR 32, EN 55032	class B
Industrial scientific and medical (ISM) radio-frequency equipment electromagnetic disturbance characteristics limits and methods of measurement	IEC/CISPR 11, EN 55011	class B
Voltage sags	SEMI F47	passed
Federal Communications Commission	FCC15	compliant

CP-C.1 range

Technical data

Data at $T_a = 25\text{ °C}$, $U_{in} = 230\text{ V AC}$ and rated values, unless otherwise indicated

Type	CP-C.1 24/10.0, CP-C.1 24/10.0-L		CP-C.1 24/10.0-C
Input circuit - Supply circuit			
		L (+), N (-)	
Rated input voltage U_{in}		100-240 V AC, 100 - 270 V DC	
Input voltage range		85-264 V AC, 90-300 V DC	
Input current range and output power	100-240 V AC	1.2-2.7 A	
	100-270 V DC	0.9-3.1 A	
Typical input current	at 115 V AC	2.3 A	
	at 230 V AC	1.2 A	
Typical power consumption	at 230 V AC	256 W	
Rated frequency		DC, 50/60 Hz	
Frequency range	AC	45-65 Hz	
Inrush current, cold state		< 11 A	
Let-through energy I^2t , cold state	at 230 V AC	< 1,5 A ² s	
Discharge current towards PE		< 3.5 mA	
Hold-up time	at 115 V AC	min. 40 ms	
	at 230 V AC	min. 40 ms	
Internal input fuse		T6.3 A, not exchangeable	
Recommended backup fuse for wire protection at 1.5 mm ²		1 pole miniature circuit breaker ABB type S 200 For USA/CAN: Use appropriate branch circuit 20 A fuse acc. regional and national regulations.	
	characteristic	B or C	
	max. rating	16 A	
Power factor correction (PFC)		yes, active	
Transient overvoltage protection		yes, varistor	
User interface			
Indication of operational states			
Output voltage	LED 'OUTPUT OK' (green)	ON	$\geq 92\%$ of adjusted U_{out}
		flashing	< 90 % of adjusted U_{out}
Power reserve	LED 'I > I _R ' (yellow)	OFF	$I \leq I_R$
		ON	$I > I_R$
Output circuit - Power output			
		L+, L-	
Rated output voltage		24 V DC	
Tolerance of the output voltage		$\pm 1\%$	
Adjustment range of the output voltage		22.5-28.5 V DC	
Rated output power		240 W	
Rated output current I_R	$-25\text{ °C} \leq T_a \leq 60\text{ °C}$	10.0 A	-
	$-40\text{ °C} \leq T_a \leq 60\text{ °C}$	-	10.0 A
Reserve output current	$-25\text{ °C} \leq T_a \leq 40\text{ °C}$	15.0 A continuously	-
	$-40\text{ °C} \leq T_a \leq 60\text{ °C}$	-	15.0 A continuously
Short-circuit current limiting		15.5 A	15.5 A
Derating of the output current	$60\text{ °C} < T_a \leq 70\text{ °C}$	2.5 %/°C	2.5 %/°C
Deviation width of output voltage	static output voltage deviation 25-100 %	< 1%	
		dynamic 0-100 % < 5 %	
	change of input voltage within the rated input voltage	< 0.1 %	
Recovery time T_A		< 1 ms	
Starting time after applying the supply voltage		< 500 ms	
Residual ripple and switching peaks	BW = 20 MHz	< 120 mV _{pp} , class A	
Parallel connection		yes, up to 5 devices, to enable redundancy and to increase power, current not symmetrical	
Series connection		yes, max. 2 devices to increase voltage	

CP-C.1 range

Technical data

Type	CP-C.1 24/10.0, CP-C.1 24/10.0-L	CP-C.1 24/10.0-C
No-load, overload and short-circuit behavior		
Characteristic curve of output	U/I characteristic curve with power reserve	
Short-circuit protection	continuous short-circuit stability	
Short-circuit behavior	current limiting	
Resistance to reverse feed	≤ 35 V DC	
Overload protection	constant current limitation	
Overtemperature protection	protection by switch off in case of overtemperature (thermal protection), automatic restart	
No-load protection	continuous no-load stability	
Starting of capacitive loads	yes	
Signaling outputs		
OUTPUT OK signaling output		
Type of output	13-14	relay, n/o contact
ON (contact closed)	≥ 92 % of adjusted U_{out}	
OFF (contact open)	< 90 % of adjusted U_{out}	
Contact ratings	max. switching voltage / current	30 V AC - 0.5 A / 24 V DC - 1 A (resistive load)
	min. switching voltage / current	5 V DC / 1 mA
POWER RESERVE signaling output		
Type of output	$I > I_R$	transistor, short-circuit proof
Active / ON (closed)	$I > I_R$	
Inactive / OFF (open)	$I \leq I_R$	
Ratings	voltage/current	24 V DC / ≤ 20 mA
General data		
Efficiency	at rated output power	up to 94 %
Power loss	at rated output power	16 W
	at 50% of rated output power	12 W
	at no load	< 3.6 W
Duty cycle	100 %	
MTBF	acc. to MIL 217 HDBK	on request
Dimensions	see "Dimensional drawings"	
Material of housing	cover	zinc-coated sheet-steel
	housing shell	aluminium
	front	plastic, PA6, V-0
Mounting	DIN rail (IEC/EN 60715), snap-on mounting	
Mounting position	see "Mounting positions" in the data sheet	
Minimum distance to other units	horizontal	25 mm (0.98 in)
	vertical	25 mm (0.98 in)
Degree of protection (IEC/EN 60529)	housing / terminals	IP20 / IP20
Protection class (IEC/EN 61140)	I	
Electrical connection		
Input circuits (L(+), N(-), PE)		
Connecting capacity	rigid	0.5-4.0 mm ² (20-10 AWG)
	fine-strand with(out) wire end ferrule	0.5-2.5 mm ² (20-12 AWG)
Stripping length	8 mm (0.315 in)	
Tightening torque	0.5 Nm (4.4 lb.in)	
Recommended screw driver	PH1 / Ø 4.0 x 0.8 mm	
Output circuits (L+, L+, L-, L-)		
Connecting capacity	rigid	0.5-4.0 mm ² (20-10 AWG)
	fine-strand with(out) wire end ferrule	0.5-2.5 mm ² (20-12 AWG)
Stripping length	8 mm (0.315 in)	
Tightening torque	0.5 Nm (4.4 lb.in)	
Recommended screw driver	PH1 / Ø 4.0 x 0.8 mm	

CP-C.1 range

Technical data

Type	CP-C.1 24/10.0, CP-C.1 24/10.0-L	CP-C.1 24/10.0-C
Signaling output (I3-I4, I > IR)		
Connecting capacity	rigid	0.5-4.0 mm ² (20-10 AWG)
	fine-strand with(out) wire end ferrule	0.5-2.5 mm ² (20-12 AWG)
Stripping length	8 mm (0.315 in)	
Tightening torque	0.5 Nm (4.4 lb.in)	
Recommended screw driver	PH1 / Ø 4.0 x 0.8 mm	
Maximum cable length (applicable for I>I _R)	30 m	
Environmental data		
Ambient temperature range	operation	-25...+70 °C (-13...+158 °F)
	rated output power	-25...+60 °C (-13...+140 °F)
	storage	-40...+85 °C (-40...+185 °F)
	transportation	-40...+85 °C (-40...+185 °F)
Climatic class (IEC/EN 60721-3-1)	storage	1K2
Climatic class (IEC/EN 60721-3-2)	transportation	2K2
Climatic class (IEC/EN 60721-3-3)	operation	3K3
Damp heat, cyclic (IEC/EN 60068-2-30)	test Db: 55 °C, 2 cycles	
Vibration (IEC/EN 60068-2-6)	test Fc: 10-58 Hz, amplitude ±0.15 mm, 58-150 Hz, 2 g, 10 sweep cycles each axis	
Shock, half-sine (IEC/EN 60068-2-27)	test Ea: 30 g, 6 ms, 3 pulses each axis; bump 20 g, 11 ms, 100 pulses each axis	
Coated PCBA	no	yes
Gaseous corrosive environment withstand test (IEC/EN 60068-2-60)	-	testing method: 4 testing period: 21 days ambient conditions: 25 °C, 75 % r.h. air/volume change rate per hour: 3-6 sample not energized during exposure gas concentrations acc. ISA-S71.04.2013 Harsh Group A, G3 IEC 60721-3.3 acc. 3C2/3C3 - H ₂ S ≥ 100 ± 10 ppb - SO ₂ /SO ₃ ≥ 300 ± 20 ppb - Cl ₂ ≥ 100 ± 10 ppb - NO _x ≥ 1250 ± 20 ppb
Isolation data		
Rated impulse withstand voltage U _{imp} (EN62477-1)	input circuit / output circuit	4 kV (1.2/50 μs)
	input circuit / PE	4 kV (1.2/50 μs)
	input circuit / relay contact	4 kV (1.2/50 μs)
	output circuit / relay contact	0.5 kV (1.2/50 μs)
	relay contact / PE	0.5 kV (1.2/50 μs)
	output circuit / PE	0.5 kV (1.2/50 μs)
System voltage (EN62477-1)	input circuit / output circuit	300 V
	input circuit / PE	300 V
	input circuit / relay contact	300 V
	output circuit / relay contact	50 V
	relay contact / PE	50 V
	output circuit / PE	50 V
Overvoltage category (IEC/EN62477-1)	< 2000 m	III
	2000...5000 m	II
Overvoltage category (IEC/EN61010-1)	< 2000 m	II
Pollution degree	2	
Protective separation (IEC/EN 61010-1, IEC/EN 61010-2-201 and IEC60950-1)	input circuit / output circuit	yes
	input circuit / relay contact	yes

CP-C.1 range

Technical data

Type	CP-C.1 24/10.0, CP-C.1 24/10.0-L	CP-C.1 24/10.0-C
Standards / Directives		
Standards	IEC/EN 61204	
Low Voltage Directive	2014/35/EU	
EMC Directive	2014/30/EU	
ATEX Directive	-	2014/34/EU
RoHS Directive	2011/65/EU	
Electrical safety	IEC/EN 61010-1, IEC/EN 61010-2-201 and IEC60950-1	
Process control equipment	UL 61010-1, UL 61010-2-201 / CAN/CSA C22.2 No. 61010-1-12, CAN/CSA-IEC 61010-2-201:18	
Protective extra low voltage	PELV (IEC/EN61010-2-201)	
Safety extra low voltage	SELV (IEC/EN 61010-2-201, IEC60950-1)	
Limitation of harmonic line currents	IEC/EN 61000-3-2	
Electromagnetic compatibility		
Low-voltage power supplies, d.c. output – Part 3: Electromagnetic compatibility (EMC)	IEC/EN 61204-3	
Interference immunity to	IEC/EN 61000-6-2	
electrostatic discharge (ESD)	IEC/EN 61000-4-2	level 4, 8 kV / 15 kV (criterion A)
radiated, radio-frequency, electromagnetic field	IEC/EN 61000-4-3	level 3, 10 V/m (criterion A)
electrical fast transient / burst	IEC/EN 61000-4-4	level 4, 4 kV / 2 kV (criterion A)
surge	IEC/EN 61000-4-5	level 4, L/N 2 kV (criterion A) level 4, L,N/PE 4 kV (criterion A)
conducted disturbances, induced by radio-frequency fields	IEC/EN 61000-4-6	level 3, 10 V (criterion A)
voltage dips, short interruptions and voltage variations	IEC/EN 61000-4-11	class 3
harmonics and interharmonics	IEC/EN 61000-4-13	class 3 (Criterion A)
conducted, common mode disturbances in the frequency range 0 Hz to 150 kHz	IEC/EN 61000-4-16	level 3, 10 V
Interference emission	IEC/EN 61000-6-3	
limits for harmonic current emissions	IEC/EN 61000-3-2	class A
limitation of voltage changes etc.	IEC/EN 61000-3-3	compliant
Electromagnetic compatibility of multimedia equipment - Emission requirements	IEC/CISPR 32, EN 55032	class B
Industrial scientific and medical (ISM) radio-frequency equipment electromagnetic disturbance characteristics limits and methods of measurement	IEC/CISPR 11, EN 55011	class B
Voltage sags	SEMI F47	passed
Federal Communications Commission	FCC15	compliant

CP-C.1 range

Technical data

Data at $T_a = 25\text{ °C}$, $U_{in} = 230\text{ V AC}$ and rated values, unless otherwise indicated

Type	CP-C.1 24/20.0, CP-C.1 24/20.0-L		CP-C.1 24/20.0-C
Input circuit - Supply circuit			
		L (+), N (-)	
Rated input voltage U_{in}		100-240 V AC, 100-270 V DC	
Input voltage range		85-264 V AC, 90-300 V DC	
Input current voltage and rated output power	100-240 V AC	2.3-5.3 A	
	100-270 V DC	1.5-5.9 A	
Typical input current	at 115 V AC	4.6 A	
	at 230 V AC	2.3 A	
Typical power consumption	at 230 V AC	508 W	
Rated frequency		DC, 50/60 Hz	
Frequency range	AC	45-65 Hz	
Inrush current, cold state		< 11 A	
Let-through energy I^2t , cold state	at 230 V AC	< 3 A ² s	
Discharge current towards PE		< 3.5 mA	
Hold-up time	at 115 V AC	min. 40 ms	
	at 230 V AC	min. 40 ms	
Internal input fuse		T12 A, not exchangeable	
Recommended backup fuse for wire protection at 1.5 mm ²		1 pole miniature circuit breaker ABB type S 200 For USA/CAN: Use appropriate branch circuit 20 A fuse acc. regional and national regulations.	
	characteristic	B or C	
	max. rating	16 A	
Power factor correction (PFC)		yes, active	
Transient overvoltage protection		yes, varistor	
User interface			
Indication of operational states			
Output voltage	LED 'OUTPUT OK' (green)	ON	≥ 92 % of adjusted U_{out}
		flashing	< 90 % of adjusted U_{out}
Power reserve	LED ' $I > I_R$ ' (yellow)	OFF	$I \leq I_R$
		ON	$I > I_R$
Output circuit - Power output			
		L+, L-	
Rated output voltage		24 V DC	
Tolerance of the output voltage		± 1 %	
Adjustment range of the output voltage		22.5-28.5 V DC	
Rated output power		480 W	
Rated output current I_R	$-25\text{ °C} \leq T_a \leq 60\text{ °C}$	20 A	-
	$-40\text{ °C} \leq T_a \leq 60\text{ °C}$	-	20 A
Reserve output current	$-25\text{ °C} \leq T_a \leq 40\text{ °C}$	26.0 A continuously	-
	$-40\text{ °C} \leq T_a \leq 60\text{ °C}$	-	26.0 A continuously
Short-circuit current limiting		27.7 A	
Derating of the output current	$60\text{ °C} < T_a \leq 70\text{ °C}$	2.5 %/°C	
Deviation width of output voltage	static output voltage deviation 25-100 %	< 1 %	
		dynamical 0-100 %	
		change of input voltage within the rated input voltage	
Recovery time T_A		< 1 ms	
Starting time after applying the supply voltage		< 500 ms	
Residual ripple and switching peaks	BW = 20 MHz	< 120 mV _{pp} , class A	
Parallel connection		yes, up to 5 devices, to enable redundancy and to increase power, current not symmetrical	
Series connection		yes, max. 2 devices to increase voltage	

CP-C.1 range

Technical data

Type	CP-C.1 24/20.0, CP-C.1 24/20.0-L		CP-C.1 24/20.0-C
No-load, overload and short-circuit behavior			
Characteristic curve of output	U/I characteristic curve with power reserve		
Short-circuit protection	continuous short-circuit stability		
Short-circuit behavior	current limiting		
Resistance to reverse feed	≤ 35 V DC		
Overload protection	constant current limitation		
Overtemperature protection	protection by switch off in case of overtemperature (thermal protection), automatic restart		
No-load protection	continuous no-load stability		
Starting of capacitive loads	yes		
Signaling outputs			
OUTPUT OK signaling output			
Type of output	13-14	relay, n/o contact	
ON (contact closed)	≥ 92 % of adjusted U_{out}		
OFF (contact open)	< 90 % of adjusted U_{out}		
Contact ratings	max. switching voltage / current	30 V AC - 0.5 A / 24 V DC - 1 A (resistive load)	
	min. switching voltage / current	5 V DC / 1 mA	
POWER RESERVE signaling output			
Type of output	$I > I_R$	transistor, short-circuit proof	
Active / ON (closed)	$I > I_R$		
Inactive / OFF (open)	$I \leq I_R$		
Ratings	voltage/current	24 V DC / ≤ 20 mA	
General data			
Efficiency	at rated output power	up to 94 %	
Power loss	at rated output power	28 W	
	at 50 % of rated output power	17 W	
	at no load	< 3.6 W	
Duty cycle	100 %		
MTBF	acc. to MIL 217 HDBK	on request	
Dimensions	see "Dimensional drawings"		
Material of housing	cover	zinc-coated sheet-steel	
	housing shell	aluminium	
	front	plastic, PA6, V-0	
Mounting	DIN rail (IEC/EN 60715), snap-on mounting		
Mounting position	see "Mounting positions" in the data sheet		
Minimum distance to other units	horizontal	25 mm (0.98 in)	
	vertical	25 mm (0.98 in)	
Degree of protection (IEC/EN 60529)	housing / terminals	IP20 / IP20	
Protection class (IEC/EN 61140)	I		
Electrical connection			
Input circuits (L(+), N(-), PE)			
Connecting capacity	rigid	0.5-4.0 mm ² (20-10 AWG)	
	fine-strand with(out) wire end ferrule	0.5-2.5 mm ² (20-12 AWG)	
Stripping length	8 mm (0.315 in)		
Tightening torque	0.5 Nm (4.4 lb.in)		
Recommended screw driver	PH1 / Ø 4.0 x 0.8 mm		

CP-C.1 range

Technical data

Type	CP-C.1 24/20.0, CP-C.1 24/20.0-L		CP-C.1 24/20.0-C
Output circuits (L+, L+, L-, L-)			
Connecting capacity	rigid	2.5-16.0 mm ² (12-6 AWG)	
	fine-strand with(out) wire end ferrule	2.5-10 mm ² (12-8 AWG)	
Stripping length	10 mm (0.394 in)		
Tightening torque	1.2 Nm (10.5 lb-in)		
Recommended screw driver	PH1 / Ø 4.0 x 0.8 mm		
Signaling output (13-14, I > IR)			
Connecting capacity	rigid	0.5-4.0 mm ² (20-10 AWG)	
	fine-strand with(out) wire end ferrule	0.5-2.5 mm ² (20-12 AWG)	
Stripping length	8 mm (0.315 in)		
Tightening torque	0.5 Nm (4.4 lb.in)		
Recommended screw driver	PH1 / Ø 4.0 x 0.8 mm		
Maximum cable length (applicable for I>I _R)	30 m		
Environmental data			
Ambient temperature range	operation	-25...+70 °C (-13...+158 °F)	-40...+70 °C (-40...+158 °F)
	rated output power	-25...+60 °C (-13...+140 °F)	-40...+60 °C (-40...+140 °F)
	storage	-40...+85 °C (-40...+185 °F)	
	transportation	-40...+85 °C (-40...+185 °F)	
Climatic class (IEC/EN 60721-3-1)	storage	1K2	
Climatic class (IEC/EN 60721-3-2)	transportation	2K2	
Climatic class (IEC/EN 60721-3-3)	operation	3K3	
Damp heat, cyclic (IEC/EN 60068-2-30)	test Db: 55 °C, 2 cycles		
Vibration (IEC/EN 60068-2-6)	test Fc: 10-58 Hz, amplitude ±0.15 mm, 58-150 Hz, 2 g, 10 sweep cycles each axis		
Shock, half-sine (IEC/EN 60068-2-27)	test Ea: 30 g, 6 ms, 3 pulses each axis; bump 20 g, 11 ms, 100 pulses each axis		
Coated PCBA	no	yes	
Gaseous corrosive environment withstand test (IEC/EN 60068-2-60)	-	testing method: 4 testing period: 21 days ambient conditions: 25 °C, 75 % r.h. air/volume change rate per hour: 3-6 sample not energized during exposure gas concentrations acc. ISA-S71.04.2013 Harsh Group A, G3 IEC 60721-3.3 acc. 3C2/3C3 - H ₂ S ≥ 100 ± 10 ppb - SO ₂ /SO ₃ ≥ 300 ± 20 ppb - Cl ₂ ≥ 100 ± 10 ppb - NO _x ≥ 1250 ± 20 ppb	

CP-C.1 range

Technical data

Type	CP-C.1 24/20.0, CP-C.1 24/20.0-L CP-C.1 24/20.0-C	
Isolation data		
Rated impulse withstand voltage U_{imp} (EN62477-1)	input circuit / output circuit	4 kV (1.2/50 μ s)
	input circuit / PE	4 kV (1.2/50 μ s)
	input circuit / relay contact	4 kV (1.2/50 μ s)
	output circuit / relay contact	0.5 kV (1.2/50 μ s)
	relay contact / PE	0.5 kV (1.2/50 μ s)
	output circuit / PE	0.5 kV (1.2/50 μ s)
System voltage (EN62477-1)	input circuit / output circuit	300 V
	input circuit / PE	300 V
	input circuit / relay contact	300 V
	output circuit / relay contact	50 V
	relay contact / PE	50 V
	output circuit / PE	50 V
Overvoltage category (EN62477-1)	< 2000 m	III
	2000...5000 m	II
Overvoltage category (IEC/EN61010-1)	< 2000 m	II
Pollution degree		2
Protective separation IEC/EN61010-1, IEC/EN61010-2-201 and IEC60950-1)	input circuit / output circuit	yes
	input circuit / relay contact	yes
Standards / Directives		
Standards	IEC/EN 61204	
Low Voltage Directive	2014/35/EU	
EMC Directive	2014/30/EU	
ATEX Directive	-	2014/34/EU
RoHS Directive	2011/65/EU	
Electrical safety	IEC / EN 61010-1, IEC / EN 61010-2-201 and IEC60950-1	
Process control equipment	UL 61010-1, UL 61010-2-201 / CAN/CSA C22.2 No. 61010-1-12, CAN/CSA-IEC 61010-2-201:18	
Protective extra low voltage	PELV (IEC/EN 61010-2-201)	
Safety extra low voltage	SELV (IEC/EN 61010-2-201 and IEC60950-1)	
Limitation of harmonic line currents	IEC/EN 61000-3-2	
Electromagnetic compatibility		
Low-voltage power supplies, d.c. output – Part 3: Electromagnetic compatibility (EMC)	IEC/EN 61204-3	
Interference immunity to	IEC/EN 61000-6-2	
electrostatic discharge (ESD)	IEC/EN 61000-4-2	level 4, 8 kV / 15 kV (criterion A)
radiated, radio-frequency, electromagnetic field	IEC/EN 61000-4-3	level 3, 10 V/m (criterion A)
electrical fast transient / burst	IEC/EN 61000-4-4	level 4, 4 kV / 2 kV (criterion A)
surge	IEC/EN 61000-4-5	level 4, L/N 2 kV (criterion A) level 4, L,N/PE 4 kV (criterion A)
conducted disturbances, induced by radio-frequency fields	IEC/EN 61000-4-6	level 3, 10 V (criterion A)
voltage dips, short interruptions and voltage variations	IEC/EN 61000-4-11	class 3
harmonics and interharmonics	IEC/EN 61000-4-13	class 3 (Criterion A)
conducted, common mode disturbances in the frequency range 0 Hz to 150 kHz	IEC/EN 61000-4-16	level 3, 10 V
Interference emission	IEC/EN 61000-6-3	
limits for harmonic current emissions	IEC/EN 61000-3-2	class A
limitation of voltage changes etc.	IEC/EN 61000-3-3	compliant
Electromagnetic compatibility of multimedia equipment - Emission requirements	IEC/CISPR 32, EN 55032	class B
Industrial scientific and medical (ISM) radio-frequency equipment electromagnetic disturbance characteristics limits and methods of measurement	IEC/CISPR 11, EN 55011	class B
Voltage sags	SEMI F47	passed
Federal Communications Commission	FCC15	compliant

CP-C.1 range

Technical diagrams

CP-C.1 24/5.0, CP-C.1 24/5.0-L and CP-C.1 24/5.0-C

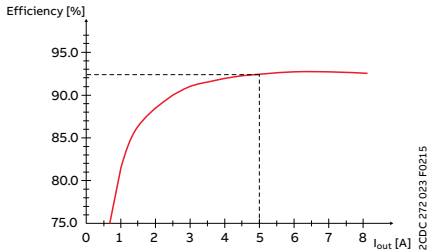

Typical efficiency over output current

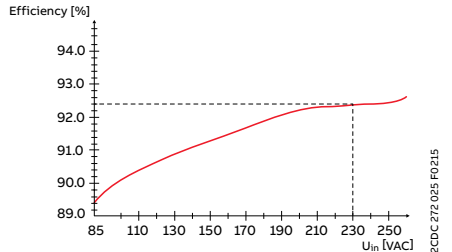

Typical efficiency over AC input voltage

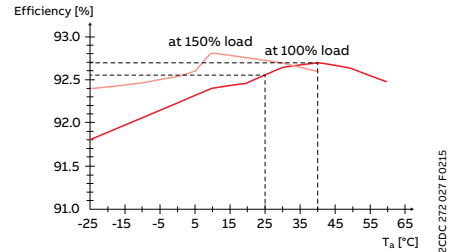

Typical efficiency over ambient temperature

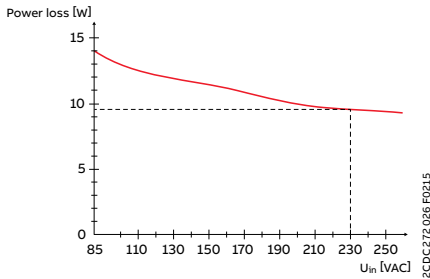

Typical power loss over AC input voltage

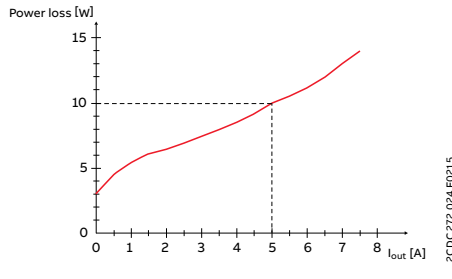

Typical power loss over output current

CP-C.1 24/10.0, CP-C.1 24/10.0-L and CP-C.1 24/10.0-C

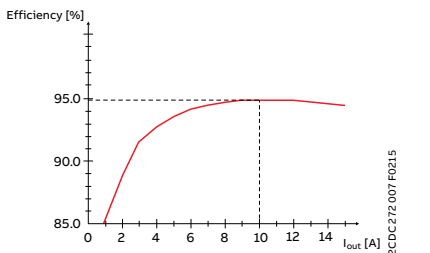

Typical efficiency over output current

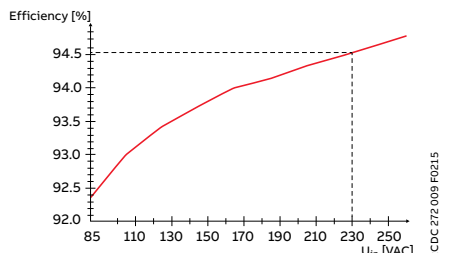

Typical efficiency over AC input voltage

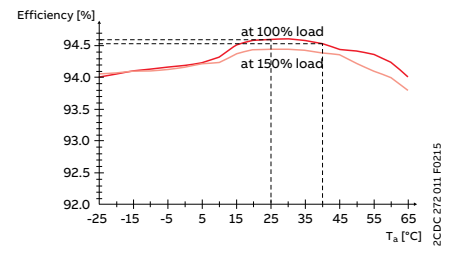

Typical efficiency over ambient temperature

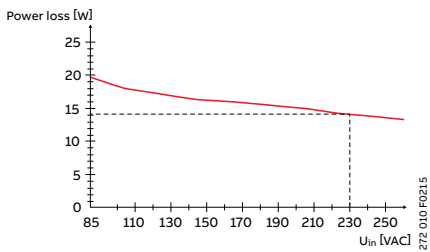

Typical power loss over AC input voltage

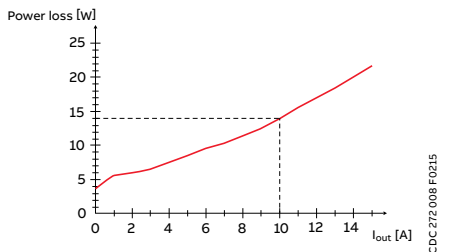

Typical power loss over output current

CP-C.1 range

Technical diagrams

CP-C.1 24/20.0, CP-C.1 24/20.0-L and CP-C.1 24/20.0-C

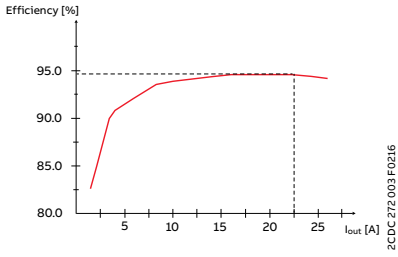

Typical efficiency over output current

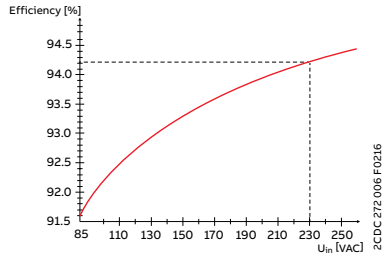

Typical efficiency over AC input voltage

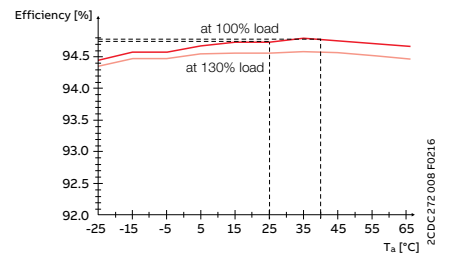

Typical efficiency over ambient temperature

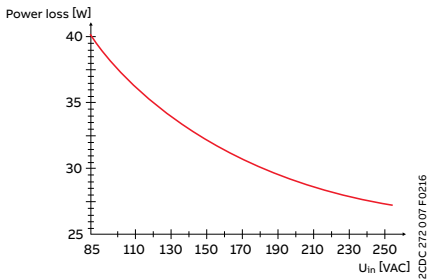

Typical power loss over AC input voltage

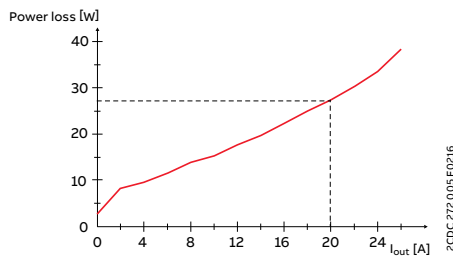

Typical power loss over output current

CP-C.1 range

Technical diagrams

Characteristic curve of output at $T_a = 25^\circ\text{C}$

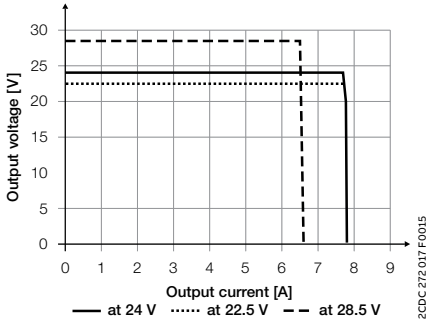

CP-C.1 24/5.0, CP-C.1 24/5.0-L
CP-C.1 24/5.0-C

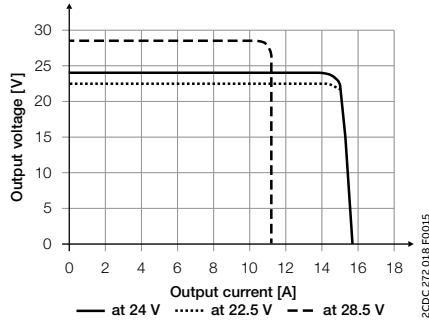

CP-C.1 24/10.0, CP-C.1 24/10.0-L
CP-C.1 24/10.0-C

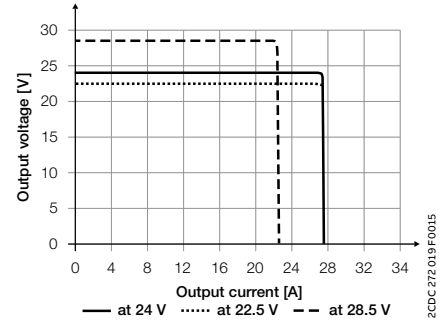

CP-C.1 24/20.0, CP-C.1 24/20.0-L
CP-C.1 24/20.0-C

Characteristic curve of temperature at $U_{out} = 24\text{ V}$

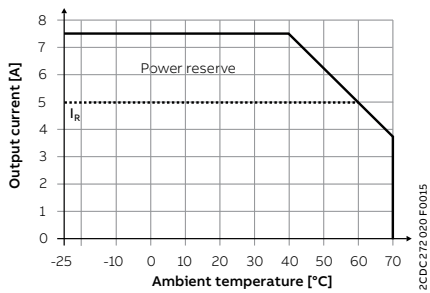

CP-C.1 24/5.0, CP-C.1 24/5.0-L

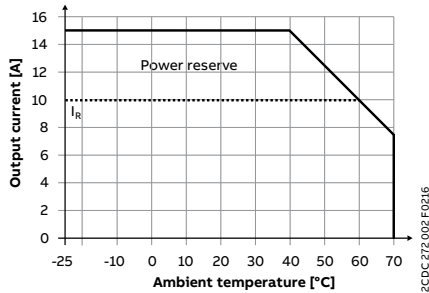

CP-C.1 24/10.0, CP-C.1 24/10.0-L

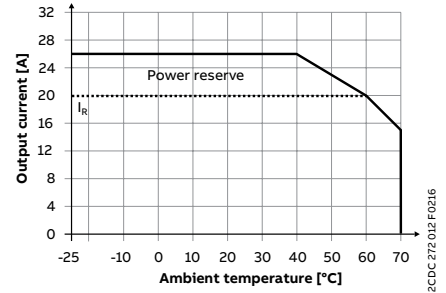

CP-C.1 24/20.0, CP-C.1 24/20.0-L

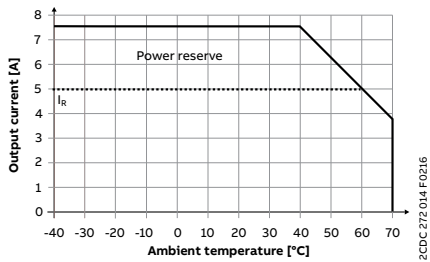

CP-C.1 24/5.0-C

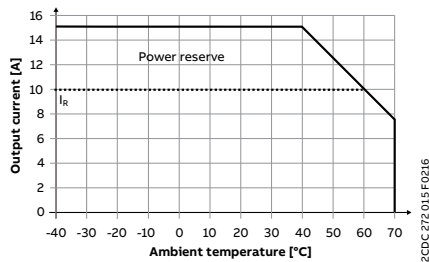

CP-C.1 24/10.0-C

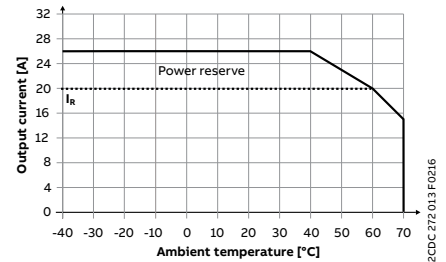

CP-C.1 24/20.0-C

CP-C.1 range

Technical diagrams

Dimensional drawings

Dimensions in mm and inches

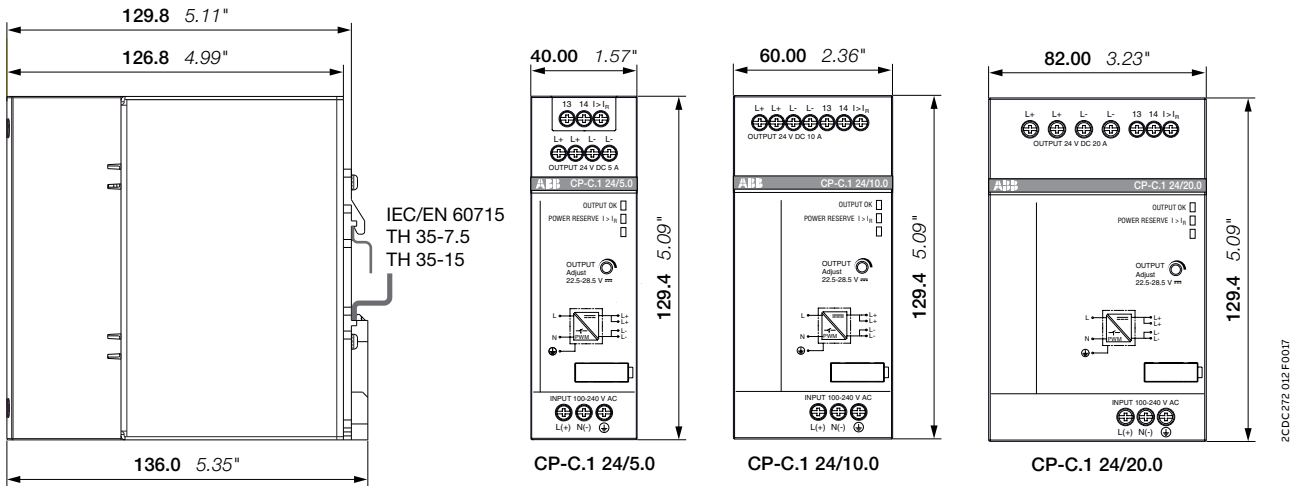





Power supplies for building applications

Table of contents

354	CP-D range
354	Benefits and advantages
356	Operation controls
357	Applications
358	Ordering details
359	Technical data
363	Technical diagrams

CP-D range

Benefits and advantages



Thanks to its compact modular housing, the CP-D range is ideal for building applications and installation. For maximum flexibility in operation, six different versions are available, from 10 W up to 100 W. Their wide input voltage range allows their use in global applications.



Easy to install

The CP-D range is easy to adjust and ideally suited for installation in distribution panels due to its width being only 18 to 90 mm.



Global availability

The product can be used in any installation in the world. Giving you the confidence of worldwide sourcing – no matter where you build, install or operate your equipment.



Speed up your projects

Data available for common planning software: Less engineering time required.

CP-D range

Benefits and advantages



Characteristics

- Output voltages 12 V, 24 V DC
- Adjustable output voltages (devices > 10 W)
- Output currents 0.42 A / 0.83 A / 1.3 A / 2.1 A / 2.5 A / 4.2 A
- Power range 10 W, 25 W, 30 W, 60 W, 100 W
- Wide range input 100-240 V AC (90-264 V AC, 120-375 V DC)
- High efficiency of up to 89 %
- Low power dissipation and low heating
- Free convection cooling (no forced cooling with ventilators)
- Ambient temperature range during operation -40...+70 °C
- Open-circuit, overload and short-circuit stable
- Integrated input fuse
- LEDs for status indication
- Light-grey housing in RAL 7035
- Various approvals and marks



Main benefits

Adjustable output voltage

The CP-D range types > 10 W feature a continuously adjustable output voltage. Thus, they can be optimally adapted to the application, for example compensating the voltage drop caused by a long line length.

Wide range input

Optimized for world-wide applications: The CP-D power supplies can be supplied with 90-264 V AC or 120-375 V DC.

Width and structural form

With their width being only 18 to 90 mm, the CP-D range switch mode power supplies are ideally suited for installation in distribution panels.

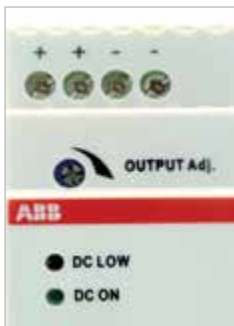

CP-D range

Operation controls

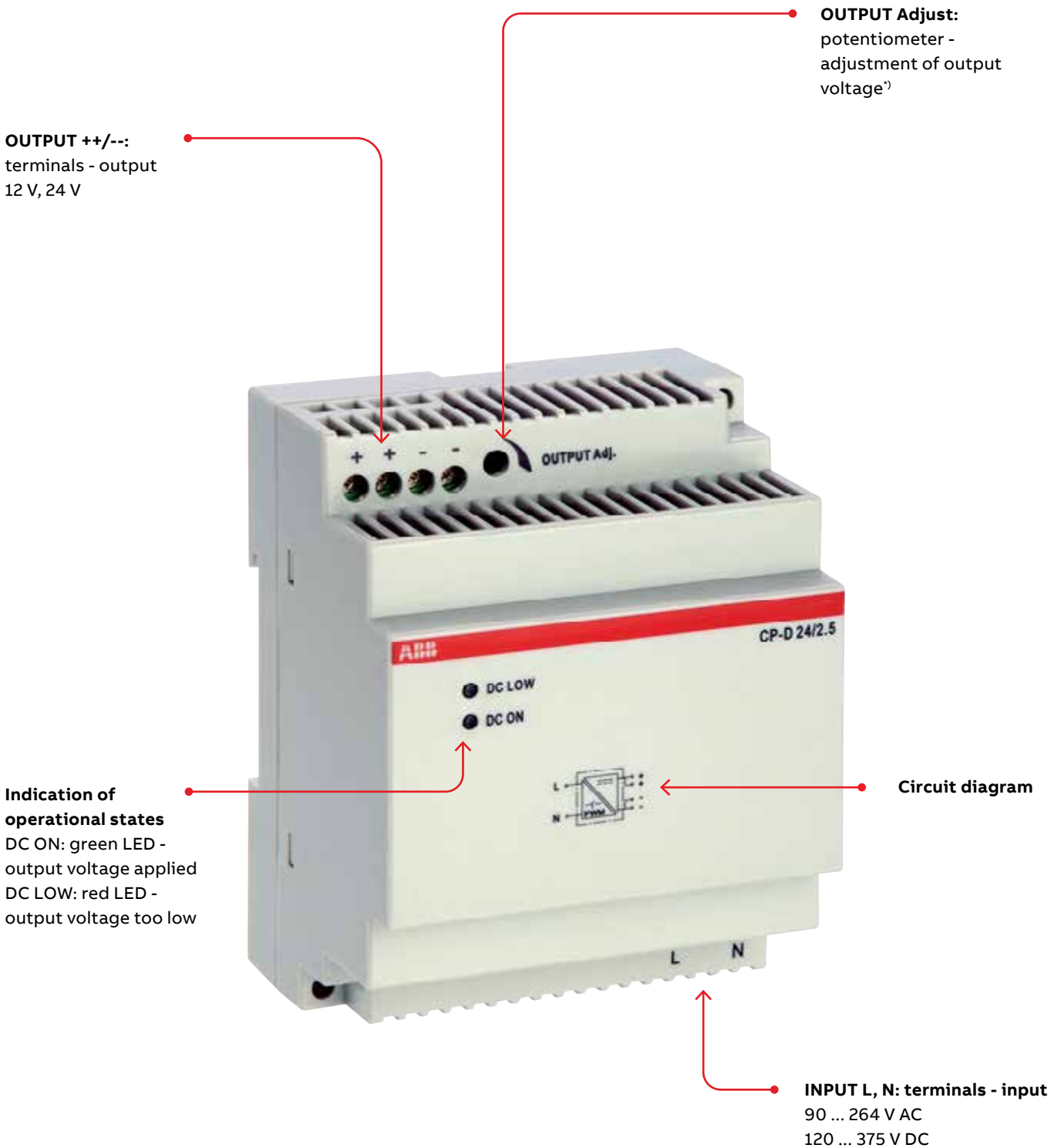

^{*)} only for devices > 10 W. 12 V version: 12...14 V DC, 24 V version: 24 ... 28 V DC.

CP-D range Applications



Emergency
lighting



Communication



Escalators



Elevators



LED
lighting

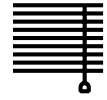

Venetian blind
drives



CP-D range

Ordering details



2CDC 271 024 F0007

CP-D 12/0.83, CP-D 24/0.42



2CDC 271 025 F0007

CP-D 12/2.1, CP-D 24/1.3



2CDC 271 028 F0007

CP-D 24/2.5

Description

The CP-D range of modular power supply units in MDRC design (modular DIN rail components) is ideally suited for installation in distribution panels. This range offers devices with output voltages of 12 V DC and 24 V DC at output currents of 0.42 A to 4.2 A. Thanks to their high thermal efficiency, these power supplies have very low power and heat dissipation and can be operated without forced cooling. All power supply units in the CP-D range are approved according to all relevant international standards.



Ordering details

Input voltage range	Rated output voltage / current	Type	Order code	Weight (1 pc.) kg (lb)
90-264 V AC/ 120-375 V DC	12 V DC / 0.83 A	CP-D 12/0.83	1SVR427041R1000	0.06 (0.13)
90-264 V AC/ 120-375 V DC	12 V DC / 2.1 A	CP-D 12/2.1	1SVR427043R1200	0.19 (0.41)
90-264 V AC/ 120-375 V DC	24 V DC / 0.42 A	CP-D 24/0.42	1SVR427041R0000	0.06 (0.13)
90-264 V AC/ 120-375 V DC	24 V DC / 1.3 A	CP-D 24/1.3	1SVR427043R0100	0.19 (0.41)
90-264 V AC/ 120-375 V DC	24 V DC / 2.5 A	CP-D 24/2.5	1SVR427044R0200	0.25 (0.56)
90-264 V AC/ 120-375 V DC	24 V DC / 4.2 A	CP-D 24/4.2	1SVR427045R0400	0.32 (0.71)

CP-D range

Technical data

Data at $T_a = 25\text{ °C}$, $U_{in} = 230\text{ V AC}$ and rated values, unless otherwise indicated

Type	CP-D 12/0.83	CP-D 12/2.1
Input circuit - supply circuit	L, N	
Rated input voltage U_{in}	100-240 V AC	
Input voltage range	90-264 V AC / 120-375 V DC	
Frequency range AC	47-63 Hz	
Typical input current / typical power consumption	at 115 V AC 200 mA / 12.68 W	502 mA / 31.14 W
	at 230 V AC 128.3 mA / 13.01 W	277 mA / 31.2 W
Inrush current	at 115 / 230 V AC 16 A / 32 A	
Power failure buffering time	min. 30 ms	
Internal input fuse	1 A slow-acting / 250 V AC	2 A slow-acting / 250 V AC
Power factor correction (PFC)	no	
Indication of operational states		
Output voltage	DC ON: green LED  : output voltage applied	
	DC LOW: red LED  : output voltage too low	
Output circuit	+, -	++, --
Rated output voltage	12 V DC	
Tolerance of the output voltage	±1 %	
Adjustment range of the output voltage	-	12-14 V DC
Rated output power	10 W	25 W
Rated output current I_r	$T_a \leq 60\text{ °C}$ 0.83 A	2.1 A
Derating of the output current	$60\text{ °C} < T_a \leq 70\text{ °C}$ 2.5 %/°C	
Maximum load change statical	max. 1 %	
deviation change of output voltage within the input voltage range with	max. 1 %	
Recover time T_A	< 1 ms	
Starting time after applying the supply voltage	at I_r 1000 ms	
Rise time	at rated load typ. 1 ms	
Residual ripple and switching peaks	BW = 20 MHz 50 mV	
Parallel connection	yes, using CP-D RU	
Series connection	yes, to increase voltage	
Resistance to reverse feed	18 V / 1 s	
Output circuit - No-load, overload and short-circuit behavior		
Characteristic curve of output	hiccup-mode	U/I characteristic curve
Short-circuit protection	continuous short-circuit stability	
Short-circuit behavior	continuation with output power limiting	
Current limiting at short circuit	typ. 1.4 A	typ. 5.9 A
Overload protection	output power limiting	
Overvoltage protection	15-16.5 V DC	
No-load protection	continuous no-load stability	
Starting of capacitive loads	unlimited	
General data		
Efficiency	typ. 78 %	typ. 82 %
Duty cycle	100 %	
Dimensions	see "Dimensional drawings"	
Material of housing	plastic	
Mounting	DIN rail (IEC/EN 60715), snap-on mounting without any tool	
Mounting position	horizontal	
Minimum distance to other units	horizontal / vertical	25 mm / 25 mm (0.98 in / 0.98 in)
Degree of protection	housing / terminals	IP20 / IP20
Protection class	II	

CP-D range

Technical data

Data at $T_a = 25\text{ °C}$, $U_{in} = 230\text{ V AC}$ and rated values, unless otherwise indicated

Type		CP-D 12/0.83	CP-D 12/2.1
Electrical connection - Input circuit / Output circuit			
Connecting capacity	fine-strand with wire end ferrule	0.2-1.5 mm ² (24-16 AWG)	0.2-2.5 mm ² (24-14 AWG)
	rigid	0.2-2.5 mm ² (26-12 AWG)	0.2-2.5 mm ² (24-12 AWG)
Stripping length		4-5 mm (0.16-0.2 in)	7 mm (0.28 in)
Tightening torque		0.6 Nm (5 lb.in)	0.7 Nm (6 lb.in)
Environmental data			
Ambient temperature range	operation	-40...+70 °C (-40...+158 °F)	
	rated load	-40...+60 °C (-40...+131 °F)	
	storage	-40...+85 °C (-40...+185 °F)	
Altitude during operation	IEC/EN 60068-2-13	max. 4850 m	
Damp heat (cyclic) (IEC/EN 60068-2-30)		4 x 24 cycles, 40 °C, 95 % RH	
Vibration (sinusoidal) (IEC/EN 60068-2-6)		50 m/s ² , 10 Hz - 2 kHz	
Shock (half-sine) (IEC/EN 60068-2-27)		40 m/s ² , 22 ms	
Isolation data			
Rated insulation voltage U_i	input circuit / output circuit	3 kV AC	
Pollution degree		2	
Overvoltage category		II	
Standards / Directives			
Standards		IEC/EN 62368-1	
Low Voltage Directive		2014/35/EU	
EMC Directive		2014/30/EU	
RoHS Directive		2011/65/EU	
Protective low voltage		SELV (IEC 60950-1)	
Electromagnetic compatibility			
Interference immunity to		IEC/EN 61000-6-2	
electrostatic discharge	IEC/EN 61000-4-2	level 4 (4 kV / 8 kV)	level 4 (4 kV / 15 kV)
radiated, radio-frequency, electromagnetic field	IEC/EN 61000-4-3	level 3 (10 V/m)	
electrical fast transient/burst	IEC/EN 61000-4-4	level 4 (4 kV)	
surge	IEC/EN 61000-4-5	level 3 (2 kV L-L)	
conducted disturbances, induced by radio-frequency fields	IEC/EN 61000-4-6	level 3 (10 V)	
Interference emission		IEC/EN 61000-6-3	
high-frequency radiated		class B	
high-frequency conducted		class B	

CP-D range

Technical data

Data at $T_a = 25\text{ }^\circ\text{C}$, $U_{in} = 230\text{ V AC}$ and rated values, unless otherwise indicated

Type	CP-D 24/0.42	CP-D 24/1.3	CP-D 24/2.5	CP-D 24/4.2
Input circuit - supply circuit	L, N			
Rated input voltage U_{in}	100-240 V AC			
Input voltage range	90-264 V AC / 120-375 V DC			
Frequency range AC	47-63 Hz			
Typical input current / typical power consumption	at 115 V AC 184 mA / 11.62 W	600 mA / 37.92 W	1120 mA / 69.3 W	1800 mA / 117.3 W
	at 230 V AC 120.6 mA / 12 W	344 mA / 38.16 W	660 mA / 70.1 W	900 mA / 114.4 W
Inrush current	at 115 / 230 V AC max. 16 A / 32 A max. 25 A / 50 A max. 30 A / 60 A			
Power failure buffering time	min. 30 ms		min. 60 ms	
Internal input fuse	1 A slow-acting / 250 V AC	2 A slow-acting / 250 V AC		3.15 A slow- acting / 250 V AC
Power factor correction (PFC)	no			
Indication of operational states				
Output voltage	DC ON: green LED	[]: output voltage applied		
	DC LOW: red LED	[]: output voltage too low		
Output circuit	+, -		++, --	
Rated output voltage	24 V DC			
Tolerance of the output voltage	±1 %			
Adjustment range of the output voltage	-	24-28 V DC		
Rated output power	10 W	30 W	60 W	100 W
Rated output current I_r	$T_a \leq 60\text{ }^\circ\text{C}$: 0.42 A	$T_a \leq 60\text{ }^\circ\text{C}$: 1.3 A	$T_a \leq 55\text{ }^\circ\text{C}$: 2.5 A	$T_a \leq 60\text{ }^\circ\text{C}$: 4.2 A
Derating of the output current	$60\text{ }^\circ\text{C} < T_a \leq 70\text{ }^\circ\text{C}$: 2.5 %/ $^\circ\text{C}$	$60\text{ }^\circ\text{C} < T_a \leq 70\text{ }^\circ\text{C}$: 2.5 %/ $^\circ\text{C}$	$55\text{ }^\circ\text{C} < T_a \leq 70\text{ }^\circ\text{C}$: 2.5 %/ $^\circ\text{C}$	$60\text{ }^\circ\text{C} < T_a \leq 70\text{ }^\circ\text{C}$: 2.5 %/ $^\circ\text{C}$
Maximum load change statical deviation with change of output voltage within the input voltage range	max. 1 %			
Recover time T_A	< 1 ms			
Starting time after applying the supply voltage	at I_r 1000 ms			
Rise time	at rated load typ. 1 ms			
Residual ripple and switching peaks	BW = 20 MHz 50 mV			
Parallel connection	yes, using CP-D RU			
Series connection	yes, to increase voltage			
Resistance to reverse feed	35 V / 1 s			
Output circuit - No-load, overload and short-circuit behavior				
Characteristic curve of output	hiccup-mode	U/I characteristic curve		
Short-circuit protection	continuous short-circuit stability			
Short-circuit behavior	continuation with output power limiting			
Current limiting at short circuit	typ. 0.78 A	typ. 4.2 A	typ. 6.05 A	typ. 11.5 A
Overload protection	output power limiting			
Overvoltage protection	30-33 V DC			
No-load protection	continuous no-load stability			
Starting of capacitive loads	unlimited			
General data				
Efficiency	typ. 80 %	typ. 83 %	typ. 86 %	typ. 89 %
Duty cycle	100 %			
Dimensions	see "Dimensional drawings"			
Material of housing	plastic			
Mounting	DIN rail (IEC/EN 60715), snap-on mounting without any tool			
Mounting position	horizontal			
Minimum distance to other units	horizontal / vertical	25 mm / 25 mm (0.98 in / 0.98 in)		
Degree of protection	housing / terminals	IP20 / IP20		
Protection class	II			

CP-D range

Technical data

Data at $T_a = 25\text{ °C}$, $U_{in} = 230\text{ V AC}$ and rated values, unless otherwise indicated

Type		CP-D 24/0.42	CP-D 24/1.3	CP-D 24/2.5	CP-D 24/4.2
Electrical connection - Input circuit / Output circuit					
Connecting capacity	fine-strand with wire end ferrule	0.2-1.5 mm ² (24-16 AWG)	0.2-2.5 mm ² (24-14 AWG)		
	rigid	0.2-2.5 mm ² (26-12 AWG)	0.2-2.5 mm ² (24-12 AWG)		
Stripping length		4-5 mm (0.16-0.2 in)		7 mm (0.28 in)	
Tightening torque		0.6 Nm (5 lb.in)		0.7 Nm (6 lb.in)	
Environmental data					
Ambient temperature range	operation	-40...+70 °C			
	rated load	-40...+60 °C		-40...+55 °C	-40...+60 °C
	storage	-40...+85 °C			
Altitude during operation	IEC/EN 60068-2-13	max. 4850 m			
Damp heat (cyclic) (IEC/EN 60068-2-30)		4 x 24 cycles, 40 °C, 95 % RH			
Vibration (sinusoidal) (IEC/EN 60068-2-6)		50 m/s ² , 10 Hz - 2 kHz			
Shock (half-sine) (IEC/EN 60068-2-27)		40 m/s ² , 22 ms			
Isolation data					
Rated insulation voltage U_i	input circuit / output circuit	3 kV AC		4 kV AC	3 kV AC
Pollution degree		2			
Overvoltage category		II			
Standards / Directives					
Standards		IEC/EN 62368-1			
Low Voltage Directive		2014/35/EU			
EMC Directive		2014/30/EU			
RoHS Directive		2011/65/EU			
Protective low voltage		SELV (IEC 60950-1)			
Electromagnetic compatibility					
Interference immunity to		IEC/EN 61000-6-2			
electrostatic discharge	IEC/EN 61000-4-2	level 4 (4 kV / 8 kV)	level 4 (4 kV / 15 kV)		level 4 (4 kV / 8 kV)
		radiated, radio-frequency, electromagnetic field	IEC/EN 61000-4-3	level 3 (10 V/m)	
electrical fast transient/burst	IEC/EN 61000-4-4	level 4 (4 kV)			
surge	IEC/EN 61000-4-5	level 3 (2 kV L-L)			
conducted disturbances, induced by radio-frequency fields	IEC/EN 61000-4-6	level 3 (10 V)			
Interference emission		IEC/EN 61000-6-3			
high-frequency radiated		class B			
high-frequency conducted		class B			

CP-D range

Technical diagrams

Characteristic curve of output at $T_a = 25^\circ\text{C}$

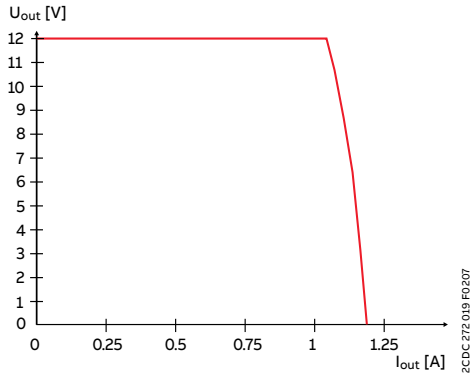

CP-D 12/0.83

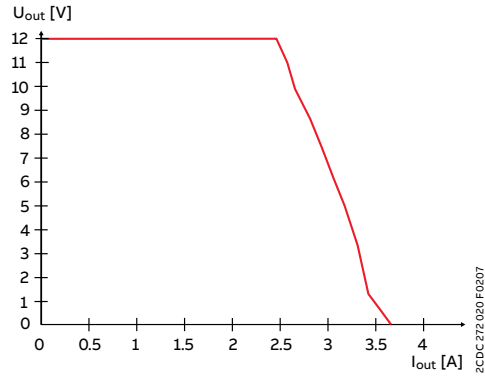

CP-D 12/2.1

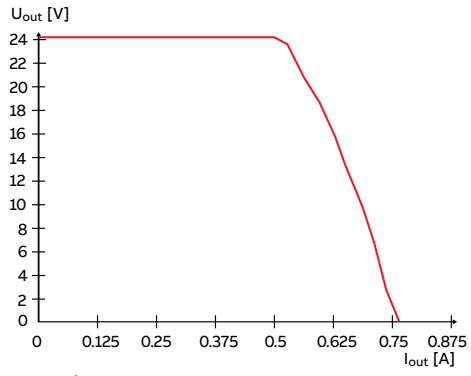

CP-D 24/0.42

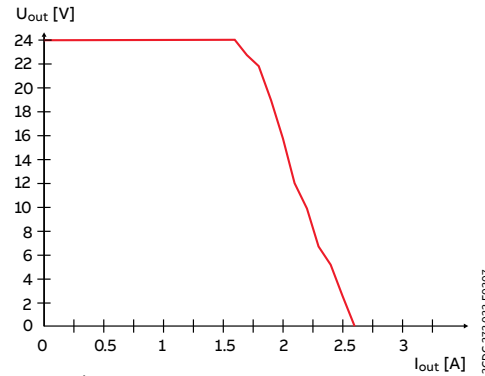

CP-D 24/1.3

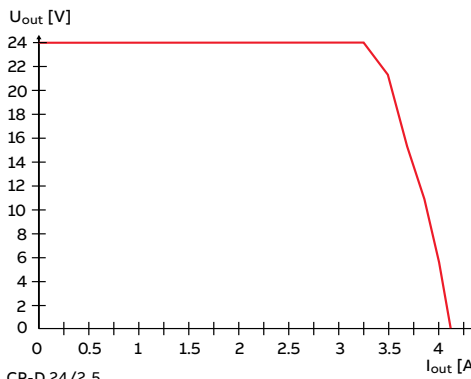

CP-D 24/2.5

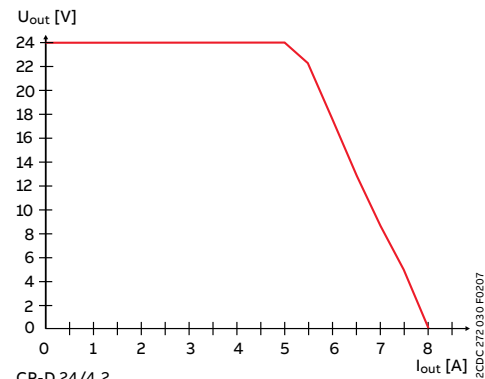

CP-D 24/4.2

Characteristic curve of temperature at rated output voltage

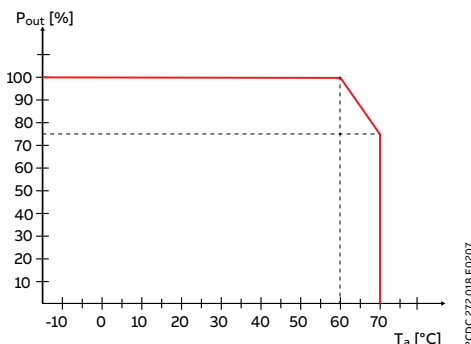

CP-D except CP-D 24/2.5

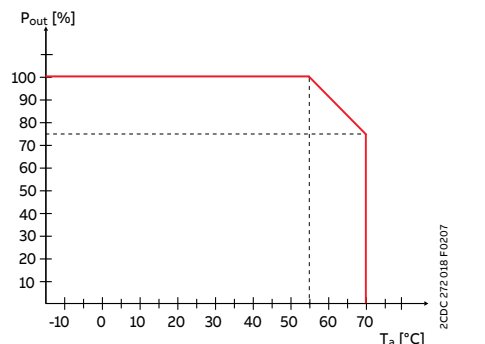

CP-D 24/2.5

CP-D range

Technical diagrams

Dimensional drawings

Dimensions in mm and inches

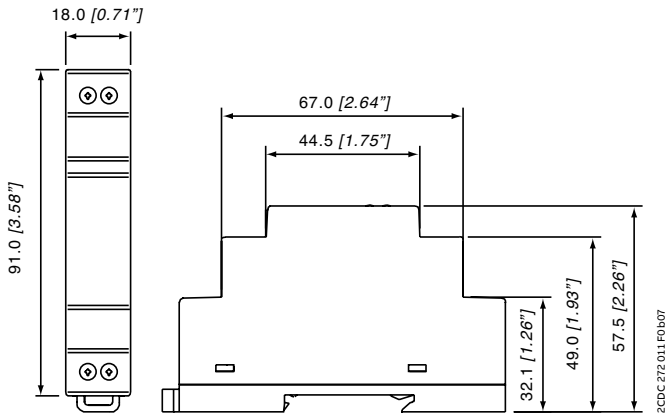

CP-D 12/0.83, CP-D 24/0.42

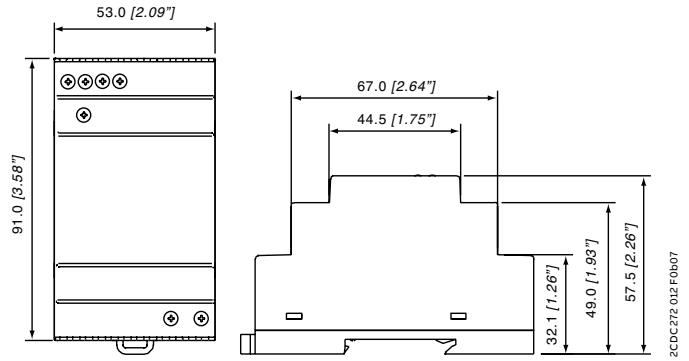

CP-D 12/2.1, CP-D 24/1.3

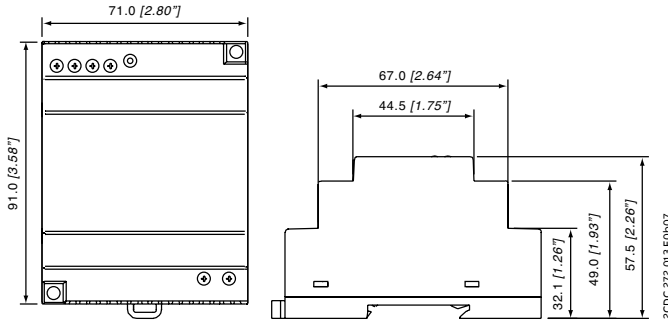

CP-D 24/2.5

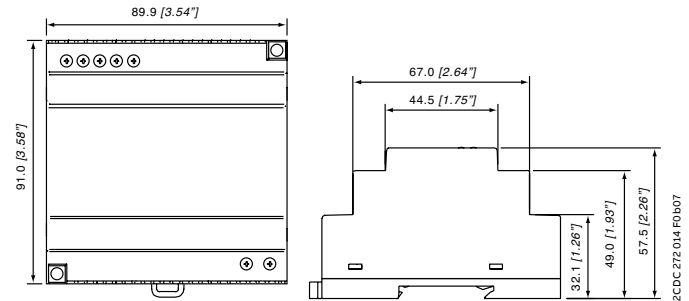

CP-D 24/4.2



CP-B range

Table of contents

368	Benefits and advantages
370	Operation controls
371	Applications
372	Ordering details
373	Technical data
375	Technical diagrams

CP-B range

Benefits and advantages



ABB's ultra-capacitor based CP-B buffer modules serve to ensure a short-term uninterrupted power supply system with a voltage of 24 V DC by buffering the load in case of power loss.

The buffer modules feature a technology for storing energy: the use of ultra-capacitors obviates the need for maintenance and exempts deep discharge in comparison to batteries.



**Continuous
operation**

- Buffering 24 V DC supply of up to 572 s
- Maintenance-free, ultra-capacitor technology
- Temperature resistant
- No discharge
- Small footprint

CP-B range

Benefits and advantages

Power supply systems have to be highly reliable in most areas of energy management and automation technology. Often, batteries are used for supporting the supply system in case of mains failures. Batteries have limited lifetimes depending on environmental parameters and have to be maintained regularly, which causes extra work and costs.

Using the ultra-capacitor technology, ABB offers an innovative and completely maintenance-free new product for buffering the 24 V DC supply in case of interrupted mains on the primary side of the switch mode power supply.

The CP-B range is an ultra-capacitor buffer energy storage system for power supply units which ensures a short term uninterrupted power supply system. In case of power loss, the energy stored in the capacitor guarantees that the load is continually provided for up to several hundred seconds depending on the load current.



Characteristics

- 3 buffer modules for buffering 24 V DC:
 - CP-B 24/3.0 (3 A / 1 kWh¹⁾)
 - CP-B 24/10.0 (10 A / 13.7 kWh¹⁾)
 - CP-B 24/20.0 (20 A / 8 kWh¹⁾)
- LEDs for status indication
- Relay contacts for status messaging
- Very high backup times (e.g. with CP-B 24/10.0 up to 9 minutes and 30 s minutes at 1 A load current)
- Short charging times
- High efficiency, higher than 95 %
- Wide temperature range
- DIN rail mountable, compact housing
- Extended temperature range -40...60 °C

¹⁾ internal energy buffer

		CP-B 24/3.0	CP-B 24/10.0	CP-B 24/20.0
Order code		1SVR427060R0300	1SVR427060R1000	1SVR427060R2000
Rated input voltage		24 V DC	24 V DC	24 V DC
Rated current		3 A DC	10 A DC	20 A DC
Energy storage (min.)		1.000 Ws	13.700 Ws	8.000 Ws
Typical charging time at load current	100 %	65 s	134 s	135 s
	0 %	56 s	82 s	62 s
Typical buffering time ¹⁾ at load current	100 %	13 s	50 s	15 s
	50 %	28 s	115 s	30 s
	25 %	66 s	246 s	60 s
	10 %	148 s	572 s	150 s

¹⁾ buffering time $\approx \frac{\text{energy storage} \times 0.9}{\text{current} \times \text{output voltage}}$

CP-B range

Operation controls



Input terminals
 SHUT-DOWN+,
 SHUT-DOWN-:
 Input signal terminals
 INPUT OK,
 BUFFER STATUS,
 FAILURE:
 Signalling contact –
 terminals
 L+_{IN}, L-_{IN}: Input voltage
 terminals

Indication of operational states
 OPERATION:
 Buffer module in operation
 (standby or buffering)
 INPUT OK:
 Input voltage applied
 BUFFER STATUS, FAILURE:
 details see table 'LEDs,
 status information and fault
 messages' in data sheet

Output terminals
 L+_{OUT}, L-_{OUT}, L-_{OUT}:
 Output voltage
 terminals

CP-B range Applications

Example of application

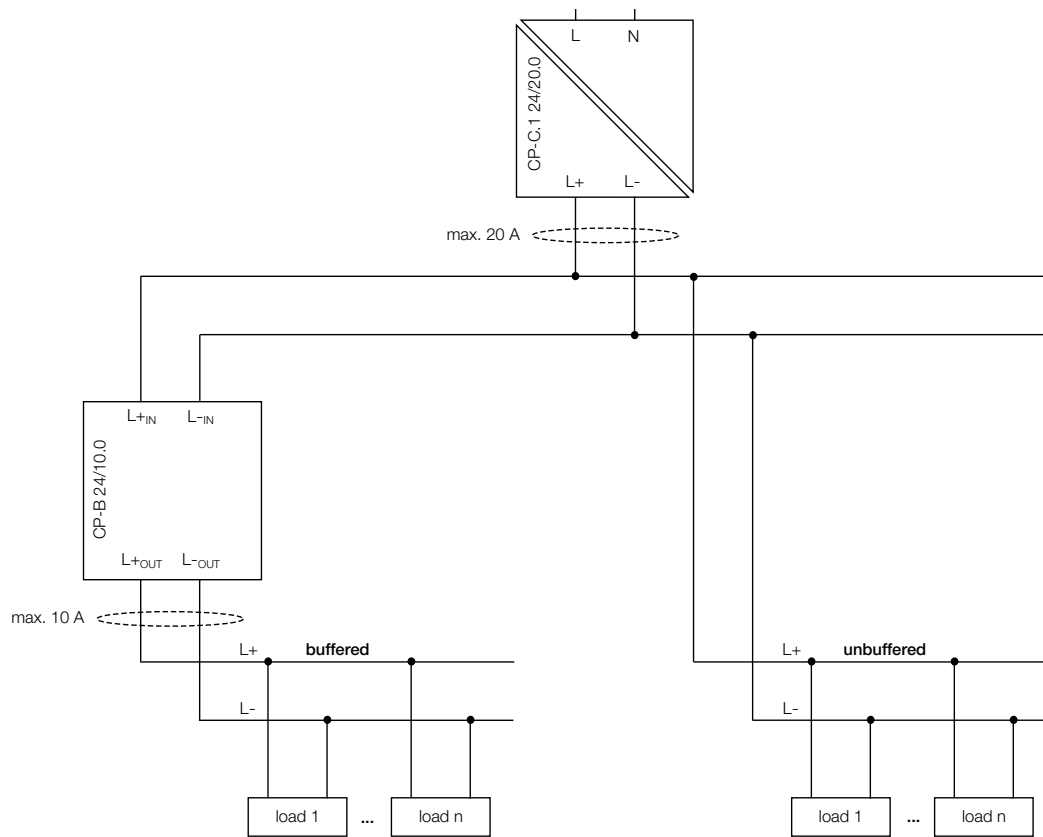

CP-B range

Ordering details



2CDC 271 004 S0010

CP-B 24/3.0



2CDC 271 002 S0010

CP-B 24/10.0



2CDC 271 003 S0010

CP-B 24/20.0

Description

Ultra capacitor based buffer units of the CP-B range offer the highest reliability also in harsh environments. Thanks to their ultra-cap based technology, the units are maintenance free, there will be no deep discharge and these products offer a very wide operational ambient temperature range. CP-B range buffer units are an excellent solution for avoiding voltage drops in solar applications, for example.

Ordering details

Rated input voltage	Rated current	Type	Order code	Weight (1 pc.) kg (lb)
24 V DC	3 A DC	CP-B 24/3.0	1SVR427060R0300	0.59 (1.31)
	10 A DC	CP-B 24/10.0	1SVR427060R1000	2.10 (4.63)
	20 A DC	CP-B 24/20.0	1SVR427060R2000	2.20 (4.85)

CP-B range

Technical data

Type		CP-B 24/3.0	CP-B 24/10.0	CP-B 24/20.0
Input circuit - Supply circuit		L_{IN} L_{-IN}		
Rated input voltage U _{in}		24 V DC		
Input voltage range		23.7-26.4 V DC	23.9-27 V DC	23.4-29 V DC
Minimum charging potential		23.7 V DC	23.9 V DC	23.4 V DC
Rated input current		3 A DC	10 A DC	20 A DC
Inrush current limiting		50 A / 1 ms	35 A / 2 ms	35 A / 2 ms
Transient overvoltage protection		suppressor diode	varistor / suppressor diode	varistor / suppressor diode
Internal input fuse (apparatus protection, not accessible)		4 A slow acting	15 A (FK2)	30 A (FK2)
Internal fuse capacitors circuit (not accessible)			25 A (FK2)	
Kind of input	SHUT-DOWN	-	control input	control input
	rated voltage	-	24 V DC	24 V DC
	voltage range	-	6-45 V DC	6-45 V DC
Output circuit		L_{OUT} L_{-OUT} L_{-OUT}		
Rated output power		69 W	240 W	480 W
Rated output voltage U _{out}		24 V DC		
Output voltage (buffer mode)		23.0 V DC	23.2 V DC	23.2 V DC
Tolerance of the output voltage		+2...-10 %		
Rated output current I _r	T _a ≤ 60 °C	3 A DC	10 A DC	20 A DC
Peak output current (fully loaded capacitors required)	T _a ≤ 60 °C	6 A DC (min. 1.5 s)	20 A DC (10 A power supply + 10 A CP-B, min. 1.5 s)	40 A DC (min. 1.5 s)
Control of limiting current		-	10.3 A DC ±0.1A	-
Shut-down if limiting current is exceeded		-	after 1.5 s	-
Short-circuit protection (only via external fuse)		no continuous short-circuit stability		
Internal output fuse (not accessible)		-	15 A (FK2)	-
Required external fuse		3.15 A slow acting	10 A slow acting	25 A slow acting
Current limiting at output circuit		-	1.05...1.2 × I _r	-
Breaking capacity of output circuit	t = 2.5 ms	-	24 V DC, 10 A	-
Power failure buffering time ¹⁾		load-dependent, min. 13 s at 100 % load	load-dependent, min. 50 s at 100 % load	load-dependent, min. 15 s at 100 % load
Overload protection		thermal protection		
Kind of output	INPUT OK	n/o contact		
	BUFFER STATUS	-	n/o contact	
	FAILURE	-	c/o contact	
Contact material		Ag + Au-clad		
Minimum switching voltage / Minimum switching current		5 V DC / 1 mA		
Maximum switching voltage / Maximum switching current		50 V AC / 1.0 A, 30 V DC / 0.5 A		
Mechanical lifetime		5 × 10 ⁶ switching cycles		
Electrical lifetime		0.1 × 10 ⁶ switching cycles		
Maximum fuse rating to achieve short-circuit protection	n/o or n/c contact	1.0 A AC / 0.5 A DC		

CP-B range

Technical data

Type		CP-B 24/3.0	CP-B 24/10.0	CP-B 24/20.0
General data				
Maximum internal power consumption		7 W	20 W	40 W
Power consumption with unloaded output		0.75 W	3 W	1.6 W
Energy storage (min.)		1000 Ws	13700 Ws	8000 Ws
Typical charging time at 24.5 V DC	100 %	65 s	134 s	135 s
	0 %	56 s	82 s	62 s
	Typical buffering time at load current ¹⁾	100 %	13 s	50 s
Typical buffering time at load current ¹⁾	50 %	28 s	115 s	30 s
	25 %	66 s	246 s	60 s
	10 %	148 s	572 s	150 s
	Efficiency	> 95 %		
Dimensions	see "Dimensional drawings"			
Material	cover / housing shell	steel sheet powdered		
Mounting		DIN rail (IEC/EN 60715), snap-on mounting		
Mounting position		horizontal		
Minimum distance to other units	horizontal	not necessary		
	vertical	40 mm (1.58 in)		80 mm (3.15 in)
Pollution degree		2		
Degree of protection	housing / terminal	IP20		
Protection class (IEC/EN 61140)		III SELV / PELV (condition: power supply fulfills class III)		
Electrical connection - Input circuit / Output circuit		pull spring terminals	pull spring terminals	pluggable screw type terminals
Connecting capacity	fine-strand with(out) wire end ferrule	0.08-1.0 mm ² (28-18 AWG)	0.08-1.5 mm ² (28-16 AWG)	0.2-4.0 mm ² (24-12 AWG)
	rigid	0.08-1.5 mm ² (28-16 AWG)	0.08-4.0 mm ² (28-12 AWG)	0.2-6.0 mm ² (24-10 AWG)
Stripping length		6.0 mm (0.24 in)		7.0 mm (0.28 in)
Signaling circuit				
Connecting capacity	fine-strand with(out) wire end ferrule	0.08-1.0 mm ² (28-18 AWG)		0.14-1.0 mm ² (26-16 AWG)
	rigid	0.08-1.5 mm ² (28-16 AWG)		0.14-1.5 mm ² (28-16 AWG)
Stripping length		6.0 mm (0.24 in)		7.0 mm (0.28 in)
Environmental data				
Ambient temperature	operation	-40...+60 °C		
	storage	-40...+60 °C		
Standards / Directives				
Standards		IEC/EN 62368-1, IEC/EN 61010-1, IEC/EN 62040-2		
Low Voltage Directive		2014/35/EU		
EMC Directive		2014/30/EU		
RoHS Directive		2011/65/EU		
Electromagnetic compatibility				
Interference immunity to		IEC/EN 61000-6-2		
electrostatic discharge	IEC/EN 61000-4-2	level 3, 6 kV / 8 kV		
radiated, radio-frequency, electromagnetic field	IEC/EN 61000-4-3	level 3, 10 V/m (27-1000 MHz) / level 2, 3 V/m (1400-2700 MHz)		
electrical fast transient/burst	IEC/EN 61000-4-4	level 3, 2(1) kV / 5 kHz		
surge	IEC/EN 61000-4-5	level 1, 0.5 kV		
conducted disturbances, induced by radio-frequency fields	IEC/EN 61000-4-6	level 3, 10 V (150 kHz-80 MHz)		
voltage dips, short interruptions and voltage variations	IEC/EN 61000-4-11	buffered by ultra-capacitors		
Interference emission		EN 61000-6-4		
high-frequency radiated	DIN EN 55011	B/C1		
high-frequency conducted	DIN EN 55011	B/C1		

¹⁾ buffering time $\approx \frac{\text{energy storage} \times 0.9}{\text{current} \times \text{output voltage}}$

CP-B range

Technical diagrams

Characteristic curve of the temperature at rated load

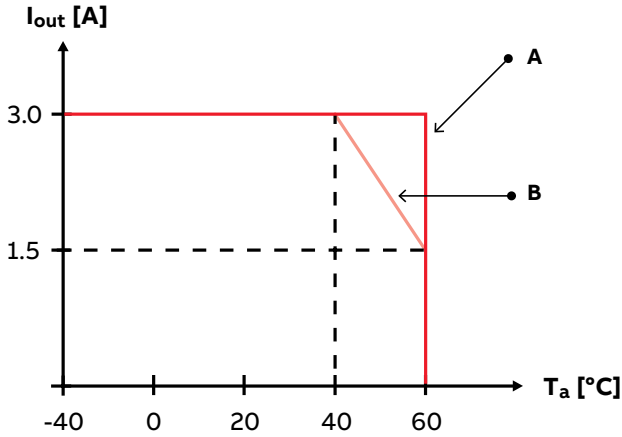

CP-B 24/3.0

2CDC272 028 F0210

Capacitors life span over temperature

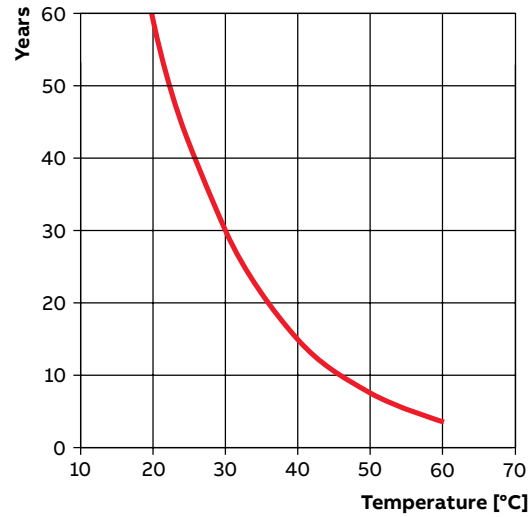

2CDC272 031 F0210

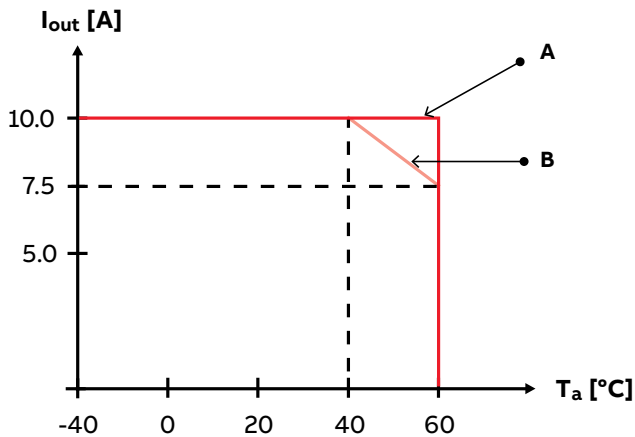

CP-B 24/10.0

2CDC272 029 F0210

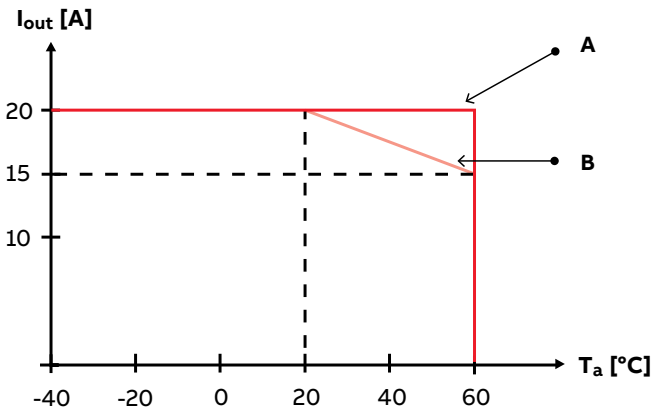

CP-B 24/20.0

2CDC272 030 F0210

- A Normal application (up to 50 % buffer mode, 5 charging and discharging cycles in direct series)
- B Continuous charging and discharging in direct series. As this is not typical of a real application, this should be considered as theoretical indication

CP-B range

Technical diagrams

Dimensional drawings

Dimensions in mm and inches

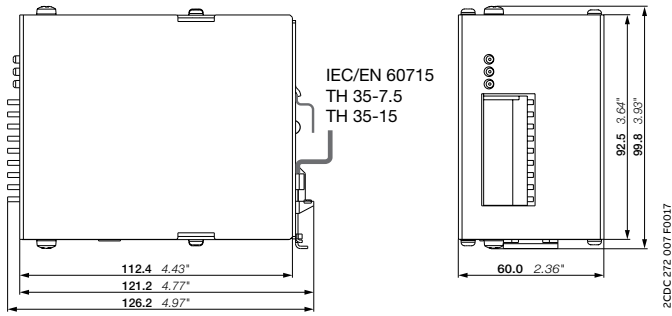

CP-B 24/3.0

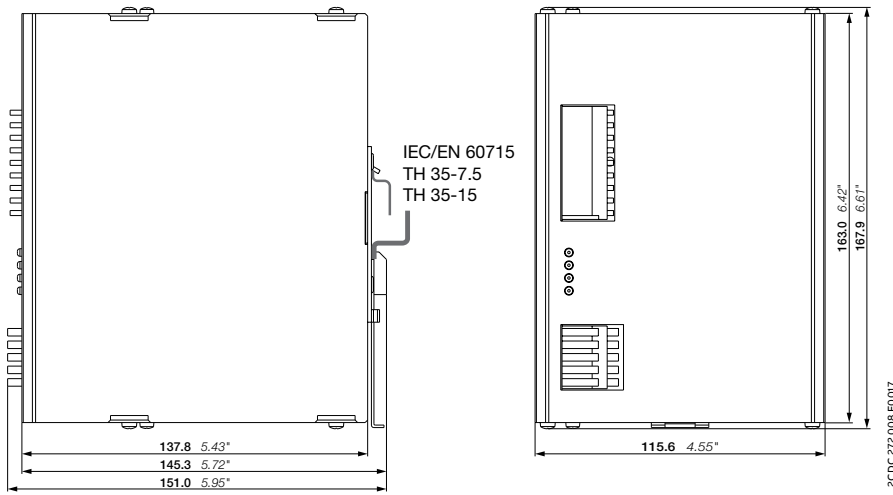

CP-B 24/10.0

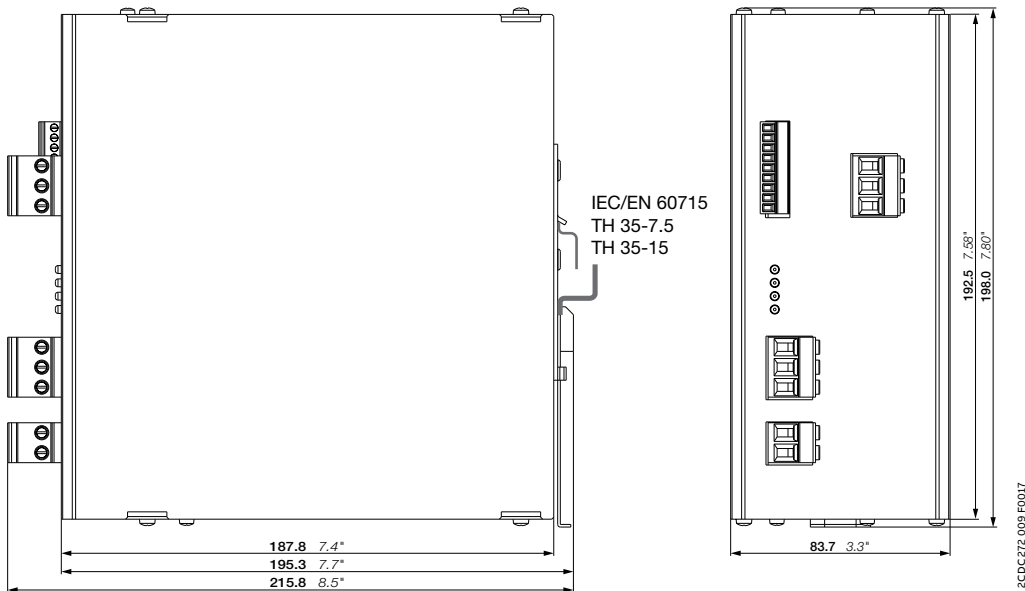

CP-B 24/20.0



Redundancy units

Table of contents

381	Benefits and advantages
382	Ordering details
383	Technical data
386	Technical diagrams

—
**Establish true redundancy
where it really matters with
ABB's power supply
redundancy units.**

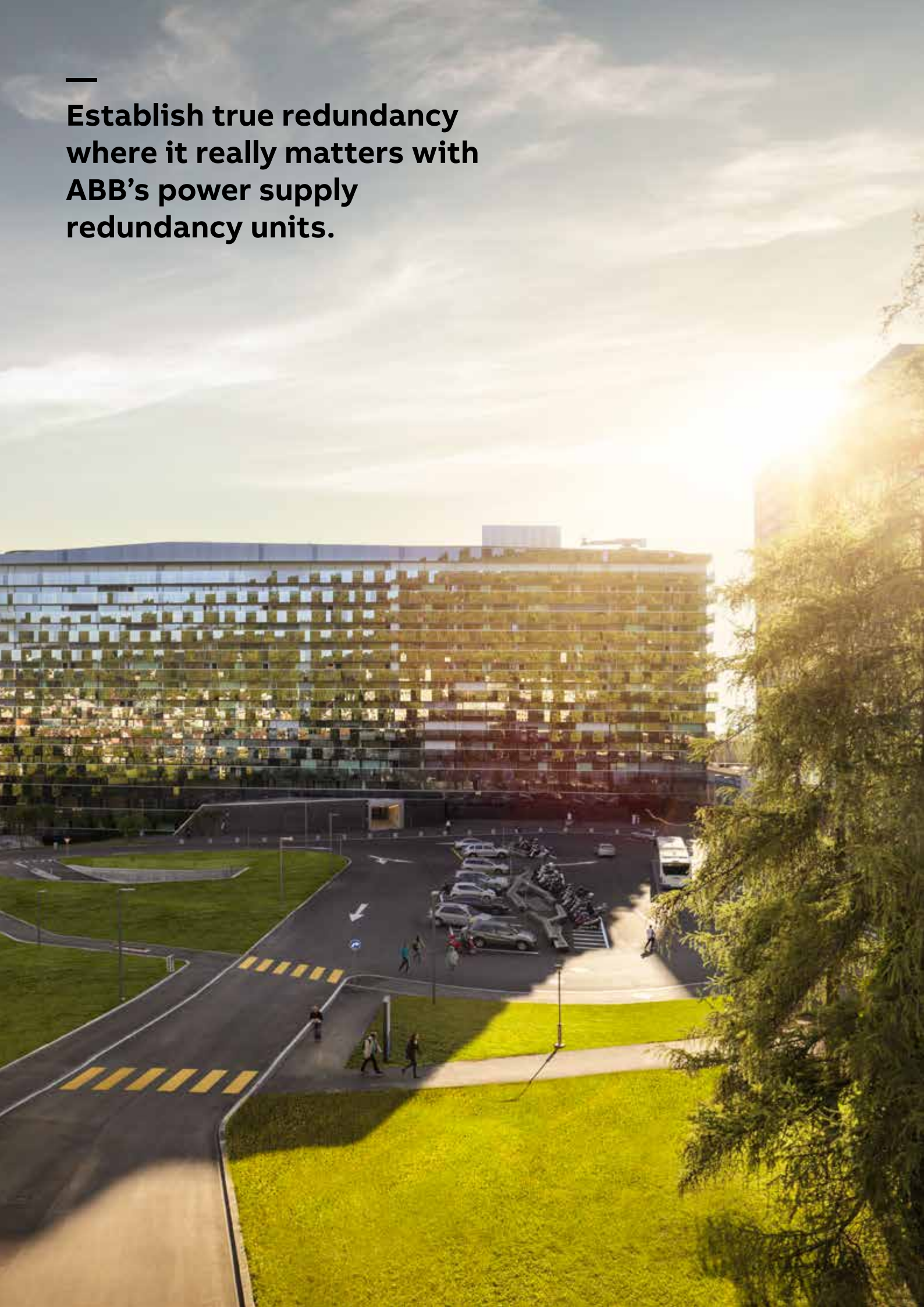

Redundancy units

Benefits and advantages



ABB's redundancy units are used to establish true redundancy, which increases the availability of electrical systems significantly. Three versions are available with different output currents and power supply housings:

- CP-D RU in MDRC housing
- CP-C.1-A-RU for a true redundant setup of two 56 V DC power supplies of the CP range



**Continuous
operation**

Highest system reliability

- Redundancy setup of the application possible to allow parallel operation
- Long lifetime

Redundancy units

Ordering details



CP-C.1-A-RU



CP-C.1-A-RU-L



CP-D RU

Description

Whenever the highest availability and reliability are key requirements, a true redundancy setup with two power supplies connected to a redundancy unit is the best solution. In case one power supply fails, the other one keeps supplying the load. Furthermore, even a short circuit in one power supply will not affect the other one, which keeps supplying the load. The CP-C.1-A-RU is also available with coated PCBA (CP-C.1-A-RU-C) for harsh environments.

Ordering details - CP-C.1-A-RU for decoupling of CP power supplies up to 20 A per input / channel

Input voltage range	Rated input current per channel	Rated output voltage / current		Type	Order code	Weight (1 pc.) kg (lb)
10 - 58 V DC	20 A	12 - 48 V DC / 2 x 20 A or 1 x 40 A	uncoated	CP-C.1-A-RU	1SVR360060R1001	1.04 (2.29)
			coated	CP-C.1-A-RU-C	1SVR360060R2001	1.04 (2.29)
			uncoated	CP-C.1-A-RU-L	1SVR361060R1001	1.04 (2.29)

Ordering details - CP-D RU for decoupling of two CP-D power supply units

Input voltage range	Rated input current per channel	Rated output voltage / current	Type	Order code	Weight (1 pc.) kg (lb)
9-35 V DC	5 A	24 V DC / 1 x 10 A	CP-D RU	1SVR427049R0000	0.075 (0.165)

Redundancy units

Technical data

Data at $T_a = 25\text{ °C}$, $U_{in} = 230\text{ V AC}$ and rated values, unless otherwise indicated

Type		CP-C.1-A-RU, CP-C.1-A-RU-L	CP-C.1-A-RU-C
Input circuit - Supply circuit		(+/, -/-)	
Rated input voltage U_{in}		12-48 V DC	
Input voltage range		10 - 58 V DC	
Rated input current I_{in} per channel	$-25\text{ °C} \leq T_a \leq 60\text{ °C}$	20 A	
Maximum input current per channel	$-25\text{ °C} \leq T_a \leq 40\text{ °C}$	30 A	
	$-40\text{ °C} \leq T_a \leq 40\text{ °C}$	-	30 A
Transient overvoltage protection		yes, varistor	
Output circuit		(+/-)	
Rated output voltage U_{out}		12 - 48 V DC	
Voltage drop input/output		typ. 0.6 V, max. 0.9 V	
Rated output current I_o	$-25\text{ °C} \leq T_a \leq 60\text{ °C}$	2 x 20 A or 1 x 40 A	
Max. output current (Power reserve)	$-25\text{ °C} \leq T_a \leq 40\text{ °C}$	2 x 30 A or 1 x 60 A	
	$-40\text{ °C} \leq T_a \leq 40\text{ °C}$	-	2 x 30 A or 1 x 60 A
Derating of the output current	$60\text{ °C} < T_a \leq 70\text{ °C}$	2.5 % per Kelvin temperature increase	
Resistance to reverse feed		< 60 V	
General data			
Power loss	input 2 x 20 A	23.0 W	
	input 2 x 10 A	9.4 W	
	input 2 x 5 A	4.1 W	
MTBF	acc. to MIL 217 HDBK	on request	
Dimensions		see "Dimensional drawings"	
Material of housing	cover / housing shell / front	aluminium / zinc-coated sheet steel / plastic	
Mounting		DIN rail (IEC/EN 60715), snap-on mounting	
Mounting position		1 and 7	
Minimum distance to other units	horizontal / vertical	25 mm (0.98 in) / 25 mm (0.98 in)	
Degree of protection (IEC/EN 60529)	housing / terminals	IP20 / IP20	
Protection class (IEC/EN 61140)		III	
Electrical connection - Input circuit / Output circuit			
Connecting capacity	fine-strand with(out) wire end ferrule	2.5-10 mm ² (12-8 AWG)	
	rigid	2.5-16 mm ² (12-6 AWG)	
Stripping length		10 mm (0.39 in)	
Tightening torque		1.2 Nm (10.5 lb.in)	
Recommended screw driver		PH1 / Ø 4.0 x 0.8 mm (0.16 x 0.03 in)	

Redundancy units

Technical data

Type		CP-C.1-A-RU, CP-C.1-A-RU-L	CP-C.1-A-RU-C
Environmental data			
Ambient temperature range	operation	-25...+70 °C (-13... +158 °F)	-40...+70 °C (-40...+158 °F)
	rated load	-25...+60 °C (-13... +140 °F)	-40...+60 °C (-40...+140 °F)
	storage	-40...+85 °C (-40...+185 °F)	
	transportation	-40...+85 °C (-40...+185 °F)	
Climatic class (IEC/EN 60721-3-1)	storage	1K2	
Climatic class (IEC/EN 60721-3-2)	transportation	2K2	
Climatic class (IEC/EN 60721-3-3)	operation	3K3	
Damp heat, cyclic (IEC/EN 60068-2-30)		test Db: 55 °C, 2 cycles	
Vibration (IEC/EN 60068-2-6)		test Fc: 10-58 Hz, amplitude ±0.15 mm, 58-150 Hz, 2 g, 10 sweep cycles each axis	
Shock, half-sine (IEC/EN 60068-2-27)		test Ea: 30 g, 6 ms, 3 pulses each axis; bump 20 g, 11 ms, 100 pulses each axis	
Coated PCBA		no	yes
Gaseous corrosive environment withstand test (IEC/EN 60068-2-60)		-	testing method: 4 testing period: 21 days ambient conditions: 25 °C, 75 % r.h. air/volume change rate per hour: 3-6 sample not energized during exposure gas concentrations acc. ISA-S71.04.2013 Harsh Group A, G3 IEC 60721-3.3 acc. 3C2/3C3 - H ₂ S ≥ 100 ± 10 ppb - SO ₂ /SO ₃ ≥ 300 ± 20 ppb - Cl ₂ ≥ 100 ± 10 ppb - NO _x ≥ 1250 ± 20 ppb
Isolation data			
Rated impulse withstand voltage U _{imp} (EN62477-1)	input / housing	1.5 kV (1.2/50 μs)	
	output / housing	1.5 kV (1.2/50 μs)	
Pollution degree		2	
Standards / Directives			
Standards		IEC/EN 61204	
EMC Directive		2014/30/EU	
ATEX Directive		-	2014/34/EU
RoHS Directive		2011/65/EU	
Electrical safety		IEC/EN 61010-1, IEC/EN 61010-2-201, IEC 60950-1	
Process control equipment		UL 61010-1, UL 61010-2-201/CAN/CSA C22.2 No. 61010-1-12, CAN/CSA-IEC 61010-2-201:18	
Electromagnetic compatibility			
Interference immunity to			
electrostatic discharge	IEC/EN 61000-4-2	Level 4, contact discharge ±8 kV, air discharge ±15 kV (criterion B)	
electrical fast transient / burst	IEC/EN 61000-4-4	Level 3, DC mains inputs and output ±2 kV (criterion B)	
surge	IEC/EN 61000-4-5	Level 1, DC mains inputs and output ±0.5 kV, input and output vs. PE ±1 kV (criterion B)	

Redundancy units

Technical data

Type	CP-D RU	
Input circuit - Supply circuit	IN 1 + + -, IN 2 + + -	
Rated input voltage U_{in}	24 V DC	
Input voltage range	9-35 V DC	
Rated input current I_{in} per channel	5 A	
Maximum input current per channel	10 A for 300 s	
Transient overvoltage protection	no	
Output circuit	OUT + + +, - - -	
Rated output voltage U_{out}	24 V DC	
Voltage drop	typ. 0.5 V	
Rated output current I_{out}	10 A	
Resistance to reverse feed	< 35 V	
General data		
MTBF	on request	
Duty cycle	100 %	
Dimensions	see "Dimensional drawings"	
Material of housing	plastic	
Mounting	DIN rail, snap-on mounting without any tool	
Mounting position	1, 7	
Minimum distance to other units	horizontal / vertical	25 mm (0.98 in) / 25 mm (0.98 in)
Electrical connection - Input circuit / Output circuit		
Connecting capacity	fine-strand with (out)wire end ferrule	0.2-2.5 mm ² (24-14 AWG)
	rigid	0.2-2.5 mm ² (24-12 AWG)
Stripping length	7.0 mm (0.28 in)	
Tightening torque	0.67 Nm (6 lb.in)	
Environmental data		
Ambient temperature range	operation	-40...+70 °C
	storage	-40...+85 °C
Relative humidity	RH at 40 °C	20-95 %, no condensation
Vibration (IEC/EN 60068-2-6)	mounting by rail: 10-500 Hz, 2 G, along X, Y, Z each axis, 60 min for each axis	
Shock (IEC/EN 60068-2-27)	15 G, 11 ms, 3 axis, 6 faces, 3 times for each face	
Standards / Directives		
Standards	IEC/EN 62368-1, IEC/EN 61204-3	
RoHS Directive	2011/65/EU	
Electromagnetic compatibility		
Interference immunity to	EN 55024	
electrostatic discharge	IEC/EN 61000-4-2	level 3, air discharge 8 kV, contact discharge 4 kV
radiated, radio-frequency, electromagnetic field	IEC/EN 61000-4-3	level 3, 10 V/m
electrical fast transient/burst	IEC/EN 61000-4-4	level 3, 2 kV / 5 kHz
conducted disturbances, induced by radio-frequency fields	IEC/EN 61000-4-6	level 3, 10 V
Interference emission	EN 55032	
high-frequency radiated	IEC/CISPR 32 / EN 55032	class B
high-frequency conducted	IEC/CISPR 32 / EN 55032	class B

Redundancy units

Technical diagrams

Dimensional drawings

Dimensions in mm and inches

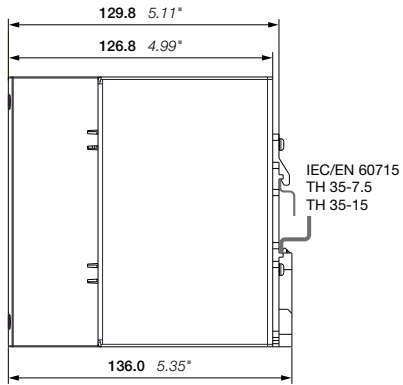

CP-C.1-A-RU, CP-C.1-A-RU-L
CP-C.1-A-RU-C

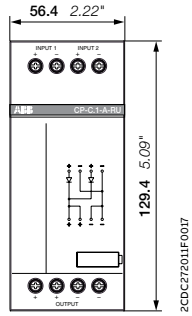

2CDC272011F0017

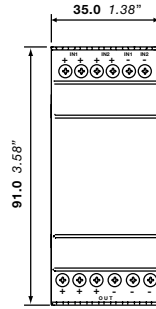

CP-D RU

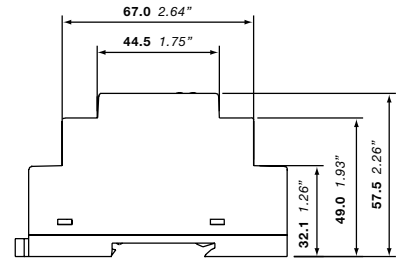

2CDC272033F0010

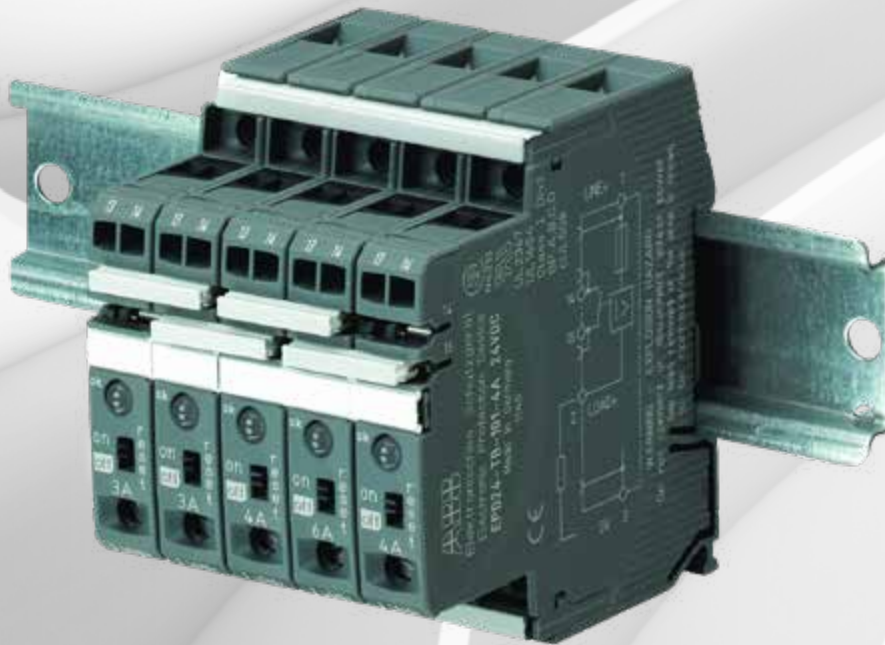

Electronic protection devices EPD24

Table of contents

390	Benefits and advantages
391	Applications
392	Ordering details
393	Operating data
394	Technical data
395	Technical information
396	Technical diagrams
397	Approvals, Safety instructions
398	Installation guidelines

Electronic protection devices EPD24

Benefits and advantages

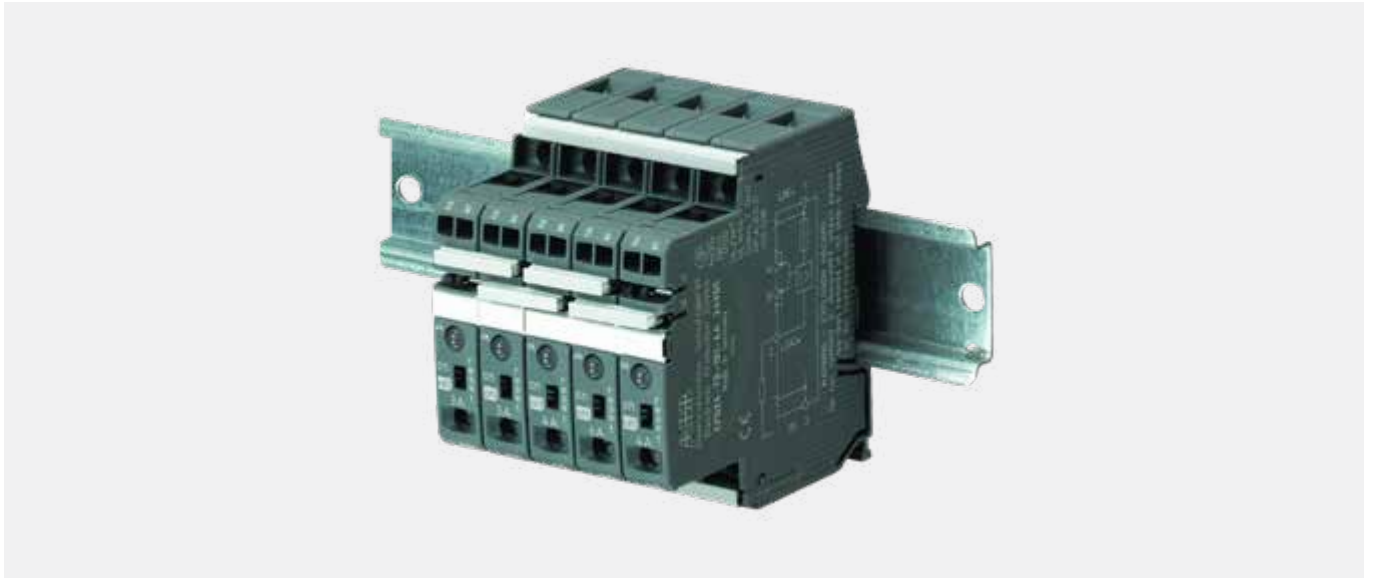

With its narrow width of only 12.5 mm, EPD24 can fit everywhere – it can even be mounted side-by-side.

Its adjustable and fixed current ratings, projectable protection through current limitation as well as a single trip curve for all types of loads allow for use in a wide field of applications.



**Continuous
operation**

Highlights

- Safety and reliability
- Operational continuity
- Worldwide use thanks to relevant certifications
- Compact and effective

Electronic protection devices EPD24

Applications



Features

- Selective load protection, one electronic tripping characteristic.
- Active current limitation for safe connection of capacitive loads up to 20,000 μF and on overload/short circuit
- Current ratings 0.5...12 A
- Reliable overload disconnection with $1.1 \times I_N$
- Manual ON/OFF button
- Clear status and failure indication through LED and integrated auxiliary contact
- Integral fail-safe element adjusted to current rating
- Width per unit only 12.5 mm
- Rail mounting
- Ease of wiring through busbar LINE+ and 0 V as well as signal bars
- UL- and CSA-approvals allow international use of the devices



Applications

- Packaging machines
- Automation
- Automation & Process Control
- Automotive Manufacturing
- Chemical, Oil & Gas
- Medical Equipment
- Pharmaceutical & Food
- Power Engineering DC 24 V
- Renewable Energy
- Steel Production



Electronic protection devices EPD24

Ordering details



EPD24-TB-101-3A

2CDC 051 001 50010

Description

The protection devices EPD24 extend the ABB product range of modular DIN rail components by electronic overcurrent protection modules for selective protection of 24 V DC load circuits. This protection is achieved by a combination of active electronic current limitation in the case of a short circuit and an overload deactivation from $1.1 \times I_n$ upwards.

If a fault occurs in a load circuit, the protection device EPD24 will detect this rapidly and reliably, then disable the power output transistor and hence interrupt the current flow in the defective circuit. The maximum possible overcurrent is always limited to 1.3...1.8 times the selected rated current. An activation of capacitive loads up to 20,000 μF is possible, deactivation only occurring in the case of overloads or short circuits. Selective deactivation of the defective current circuit means undefined error states and a complete system stop are prevented.

Ordering details

Rated current I_n	Type	Order code	Pkg qty	Weight (1 pc.) kg (lb)
A				
0.5	EPD24-TB-101-0.5A	2CDE601101R2905	4	0.065 (1.433)
1	EPD24-TB-101-1A	2CDE601101R2001	4	0.065 (1.433)
2	EPD24-TB-101-2A	2CDE601101R2002	4	0.065 (1.433)
3	EPD24-TB-101-3A	2CDE601101R2003	4	0.065 (1.433)
4	EPD24-TB-101-4A	2CDE601101R2004	4	0.065 (1.433)
6	EPD24-TB-101-6A	2CDE601101R2006	4	0.065 (1.433)
8	EPD24-TB-101-8A	2CDE601101R2008	4	0.065 (1.433)
10	EPD24-TB-101-10A	2CDE601101R2010	4	0.065 (1.433)
12	EPD24-TB-101-12A	2CDE601101R2012	4	0.065 (1.433)

Description	Type	Order code	Pkg qty	Weight (1 pc.) kg (lb)
Busbars for LINE+ and 0 V, grey insulation, length 500 mm ¹⁾	EPD-BB500	2CDE605100R0500	10	0.2 (0.441)
Signal bars for aux. contacts, grey insulation, length 21 mm	EPD-SB21	2CDE605200R0021	10	0.4 (0.882)

¹⁾ Max. load with one line entry $I_{\text{max}} = 50 \text{ A}$ (recommended: mid line entry)
Max. load with two line entries $I_{\text{max}} = 63 \text{ A}$

Electronic protection devices EPD24

Operating data

Operating data	
Operating voltage U_b	24 V DC (18...32 V)
Current rating I_N	fixed current ratings: 0.5, 1, 2, 3, 4, 6, 8, 10, 12 A
Closed current I_o	ON condition: typically 20...30 mA depending on signal output
Status indication by means of	Green: unit is ON load circuit / Power-MOSFET is switched on Orange: in the event of overload or short circuit until electronic disconnection Red: unit electronically disconnected load circuit/Power-MOSFET OFF undervoltage ($U_b < 8$ V) after switch-on till the end of the delay period OFF: manually switched off or device is dead potential-free auxiliary contact F ON/OFF/ condition of switch
Load circuit	
Load output	Power-MOSFET switching output (high side switch)
Overload disconnection	typically $1.1 \times I_N$ (1.05...1.35 $\times I_N$)
Short-circuit current I_k	active current limitation
Trip time	see time/current characteristics
For electronic disconnection	typically 3 s at $I_{Load} > 1.1 \times I_N$ typically 100 ms...3 s at $I_{Load} > 1.8 \times I_N$ (or $1.5 \times I_N/1.3 \times I_N'$)
Temperature disconnection	internal temperature monitoring with electronic disconnection
Low voltage monitoring load output	with hysteresis, no reset required: load »OFF« at $U_b < 8$ V
Starting delay t_{Start}	typically 0.5 sec after every switch-on and after applying U_b
Disconnection of load circuit	electronic disconnection
Free-wheeling circuit	suitable external free-wheeling circuit to be used with inductive load
Several load outputs must not be connected in parallel	
Signal output	
Electrical data	potential-free auxiliary contact max. 30 V DC/0.5 A, min. 10 V DC/10 mA
ON condition LED green	voltage U_b applied, switch is in ON position no overload, no short circuit
OFF condition LED off	device switched off (switch is in OFF position) no voltage U_b applied
Fault condition LED orange	overload condition $> 1.1 \times I_N$ up to electronic disconnection
Fault condition LED red	electronic disconnection upon overload or short circuit Device switched off with control signal (switch is in ON position)
Aux. contact	single signal, make contact contact open, terminal 13-14
Fault	signal output fault conditions no operating voltage U_b ON/OFF switch is in OFF position red LED lighted (electronic disconnection)

Electronic protection devices EPD24

Technical data

General data	
Fail-Safe element	backup fuse for EPD24 not required because of the integral redundant fail-safe element
Housing material	moulded
Mounting	symmetrical rail to EN 50022-35x7.5
Ambient temperature	0...+50 °C (without condensation, see EN 60204-1)
Storage temperature	-20...+70 °C
Humidity	96 hrs/95 % RH/40 °C to IEC 60068-2-78, test Cab. climate class 3K3 to EN 60721
Vibration	3 g, test to IEC 60068-2-6 test Fc
Degree of protection	housing: IP20 DIN 40050 terminals: IP20 DIN 40050
EMC (EMC directive, CE logo)	emission: EN 61000-6-3 susceptibility: EN 61000-6-2
Isolations coordination (IEC 60934)	0.5 kV/pollution degree 2 reinforced insulation in operating area
Dielectric strength	max. 32 V DC (load circuit)
Isolation resistance (OFF condition)	n/a, only electronic disconnection
Approvals/Declarations of conformity	UL 2367 Solid State Overcurrent Protectors UL 1604, (class I, division 2, groups A, B, C, D) UL 508 CSA C22.2 No. 213 (class I, division 2) CSA C22.2 No. 142 CE logo
Dimensions (B x H x T)	12.5 x 80 x 83 mm
Weight	approx. 65 g
Terminals	
Line+/LOAD+/0V	
Screw terminals	M4
Max. cable cross section flexible with wire end ferrule w/wo plastic sleeve	0.5 – 10 mm ²
Multi-lead connection (2 identical cables) rigid/flexible	0.5 – 4 mm ²
Flexible with wire end ferrule without plastic sleeve	0.5 – 2.5 mm ²
Flexible with TWIN wire end ferrule with plastic sleeve	0.5 – 6 mm ²
Wire stripping length	10 mm
Tightening torque (EN 60934)	1.5 – 1.8 Nm
Terminals	
aux. contacts	
Screw terminals	M3
Max. cable cross section flexible with wire end ferrule w/wo plastic sleeve	0.25 - 2.5 mm ²
Wire stripping length	8 mm
Tightening torque (EN 60934)	0.5 Nm

Table 1: voltage drop, current limitation, max. load current

current rating I_N	typically voltage drop U_{ON} at I_N	active current limitation (typically)	max. load current at 100 % ON duty	
			$T_{ambient} = 40\text{ °C}$	$T_{ambient} = 40\text{ °C}$
0.5 A	70 mV	$1.8 \times I_N$	0.5 A	0.5 A
1 A	80 mV	$1.8 \times I_N$	1 A	1 A
2 A	130 mV	$1.8 \times I_N$	2 A	2 A
3 A	80 mV	$1.8 \times I_N$	3 A	3 A
4 A	100 mV	$1.8 \times I_N$	4 A	4 A
6 A	130 mV	$1.8 \times I_N$	6 A	5 A
8 A	120 mV	$1.5 \times I_N$	8 A	7 A
10 A	150 mV	$1.5 \times I_N$	10 A	9 A
12 A	180 mV	$1.3 \times I_N$	12 A	10.8 A

Attention: when mounted side-by-side without convection, the ERD24 should carry no more than 80 % of its rated load with 100 % ON duty due to thermal effects.

Electronic protection devices EPD24

Technical information

Time/Current characteristic curve ($T_{\text{ambient}} = 25\text{ °C}$)

The trip time is typically 3 s in the range between 1.1 and $1.8 \times I_N^{1)}$.

Electronic current limitation occurs at typically $1.8 \times I_N^{1)}$ which means that under all overload conditions (independent of the power supply and the resistance of the load circuit) the max. overload before disconnection will not exceed $1.8 \times I_N^{1)}$ times the current rating. Trip time is between 100 ms and 3 sec (depending on overload or at short circuit).

Without this current limitation a considerably higher overload current would flow in the event of an overload or short circuit.

Maximum cable lengths

EPD24 reliably trips from $0\ \Omega$ up to max. circuit resistance R_{max} .

Calculation of R_{max}

Selected rating I_N (A)	3	6
Operating voltage U_g (V DC) (= 80 % of 24 V) ²⁾	19.2	19.2
Trip current $I_{\text{ab}} = 1.25 \times I_N$ (A) (EPD24 trips after 3 s)	3.75	7.50
$R_{\text{max}} (\Omega) = (U_g / I_{\text{ab}}) - 0.050$	5.07	2.51

²⁾ Voltage drop of EPD24 and tolerance of trip point (typically $1.1 \times I_N = 1.05 \dots 1.35 \times I_N$) have been taken into account

Selection table for the incoming cable lengths with different cable cross-sections

Cable cross section A (mm ²)	0.14	0.25	0.34	0.5	0.75	1.00	1.50
Cable length L (m) (= single length)	cable resistance (Ω) = $(\rho_0 \times 2 \times L) / A^{3)}$						
5	1.27	0.71	0.52	0.36	0.24	0.18	0.12
10	2.54	1.42	1.05	0.71	0.47	0.36	0.24
15	3.81	2.14	1.57	1.07	0.71	0.53	0.36
20	5.09	2.85	2.09	1.42	0.95	0.71	0.47
25	6.36	3.56	2.62	1.78	1.19	0.89	0.59
30	7.63	4.27	3.14	2.14	1.42	1.07	0.71
35	8.90	4.98	3.66	2.49	1.66	1.25	0.83
40	10.17	5.70	4.19	2.85	1.90	1.42	0.95
45	11.44	6.41	4.71	3.20	2.14	1.60	1.07
50	12.71	7.12	5.24	3.56	2.37	1.78	1.19
75	19.07	10.68	7.85	5.34	3.56	2.67	1.78
100	25.34	14.24	10.47	7.12	4.75	3.56	2.37
125	31.79	17.80	13.09	8.90	5.93	4.45	2.97
150	38.14	21.36	15.71	10.68	7.12	5.34	3.56
175	44.50	24.92	18.32	12.46	8.31	6.23	4.15
200	50.86	28.48	20.94	14.24	9.49	7.12	4.75
225	57.21	32.04	23.56	16.02	10.68	8.01	5.34
250	63.57	35.60	26.18	17.80	11.87	8.90	5.93

³⁾ Resistivity of copper $\rho_0 = 0.0178 (\Omega \times \text{mm}^2) / \text{m}$

Example 1: max. length for $1.5\ \text{mm}^2$ and $3\ \text{A}$: 214 m

Example 2: max. length for $1.5\ \text{mm}^2$ and $6\ \text{A}$: 106 m

Example 3: mixed wiring: (Control cabinet --- sensor/actuator level)

$R_1 = 40\ \text{m}$ for $1.5\ \text{mm}^2$ and $R_2 = 5\ \text{m}$ for $0.25\ \text{mm}^2$:

$R_1 = 0.95\ \Omega$, $R_2 = 0.71\ \Omega$, total $(R_1 + R_2) = 1.66\ \Omega$

Electronic protection devices EPD24

Technical diagrams

Time/current characteristic curve

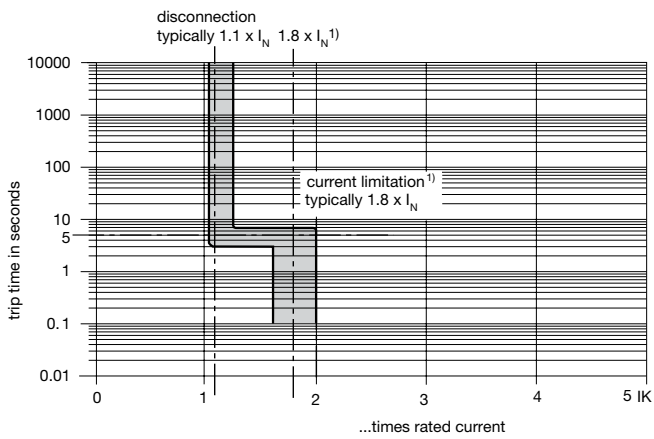

¹⁾ Current limitation typically $1.8 \times I_N$ at $I_N = 0.5 \text{ A} \dots 6 \text{ A}$
 Current limitation typically $1.5 \times I_N$ at $I_N = 8 \text{ A}$ or 10 A
 Current limitation typically $1.3 \times I_N$ at $I_N = 12 \text{ A}$

Wiring diagram

EPD24-TB-101
 without signal input
 with signal output F
 (Single signal, N/O)

Operating condition: 13-14 closed
 Fault condition: 13-14 open

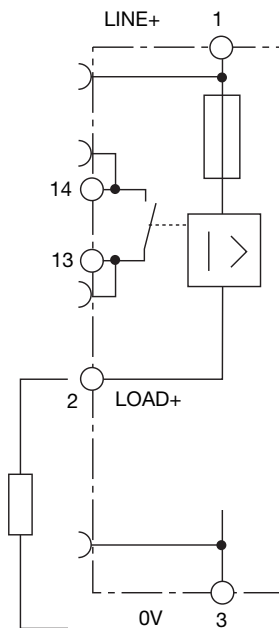

Electronic protection devices EPD24

Approvals, Safety instructions

Please note

The user must ensure that the cable cross sections of the relevant load circuit are suitable for the current rating of the EPD24 used. Automatic start-up of machinery after shut down must be prevented (Machinery Directive 2006/42/EU and IEC/EN 60204-1). In the event of a short circuit or overload the load circuit will be disconnected electronically by the EPD24.

Information on UL approvals/CSA approvals



UL1604
UL File # E 339238



CSA C22.2 No. 213 (Class I, Division 2)
CSA File # 2305929

Operating Temperature Code T5

- This equipment is suitable for use in Class I, Division 2, Groups A, B, C and D or non-hazardous locations only

WARNING:

- Exposure to some chemicals may degrade the sealing properties of materials used in the following device: relay
Sealant Material:
 - Generic Name: Modified diglycidyl ether of bisphenol A
 - Supplier: Fine Polymers Corporation
 - Type: Epi Fine 4616L-160PK
- Casing Material:
 - Generic Name: Liquid Crystal Polymer
 - Supplier: Sumitomo Chemical
 - Type: E4008, E4009, or E6008

RECOMMENDATION:

- Periodically inspect the device named above for any degradation of properties and replace if degradation is found

WARNING – EXPLOSION HAZARD:

- Do not disconnect equipment unless power has been removed or the area is known to be non-hazardous
- Substitution of any components may impair suitability for Class I, Division 2



UL2367
Non-hazardous use - UL File # E 339236



UL 508
Non-hazardous use - UL File # E 149922



CSA C22.2 No. 14
CSA C22.2 No. 142 - CSA File # E 2305929

Class 2

Meets requirement for Class 2 current limitation (EPD24 ... -0.5 A/1 A/2 A/3 A)

Electronic protection devices EPD24

Installation guidelines

The EPD24 features an integral power distribution system.

The following wiring modes are possible with various pluggable current and signal busbars:

- LINE+ (24 V DC)
- 0 V
- Caution: The electronic devices EPD24 require a 0 V connection
- Auxiliary contacts

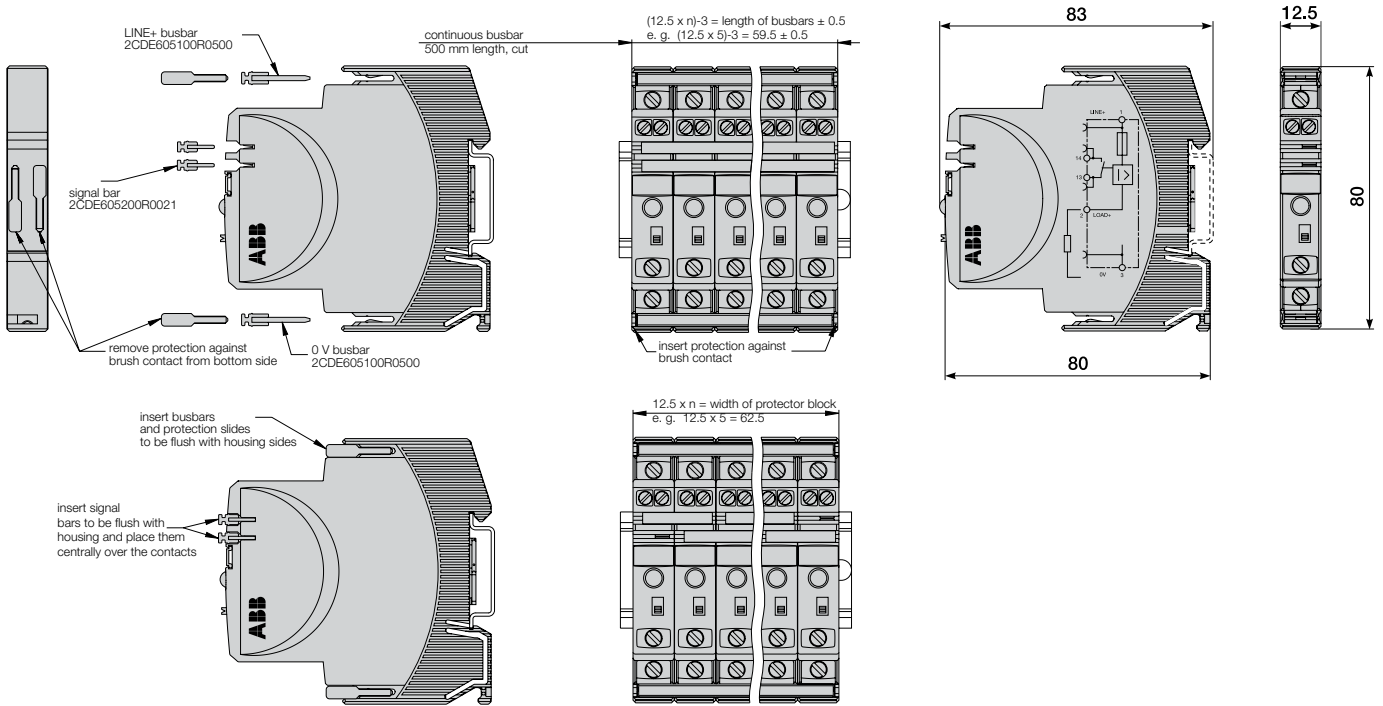

Mounting procedure

Before wiring insert busbars into protector block. A maximum of 10 connection cycles are permissible using connecting busbars.

Recommendation

After 10 units the busbars should be interrupted and receive a new entry live.

Table of length for busbars

(Order code 2CDE605100R0500)

No. of units	2	3	4	5	6	7	8	9	10
Length of busbar (mm) ± 0.5 mm	22	34.5	47	59.5	72	84.5	97	109.5	122



Interface relays and optocouplers

Table of contents

402	Offer overview
405	Applications
407	Pluggable interface relays and optocouplers
408	Selection tables
410	List of components
425	Benefits and advantages
426	Socket & terminal connection types
427	Relay components
429	Ordering details
450	Technical data
464	Technical diagrams
479	Boxed interface relays and optocouplers R600 range
480	Overview
482	Boxed interface relays R600 range
482	Selection table
484	Ordering details
486	Technical data
490	Technical diagrams
492	Boxed optocouplers R600 range
492	Selection table
493	Ordering details
495	Technical data
498	Technical diagrams

Interface relays and optocouplers

Offer overview

Relays are universally applicable and are utilized in a diverse array of applications. They are a significant element in contemporary industrial processes and are used in applications where galvanic isolation, signal separation, voltage coupling and signal amplification are required.

The ABB portfolio includes electromechanical relays and optocouplers. The electromechanical relays operate using an electromagnetic field whereas optocouplers use light. Optocouplers are predominantly used in applications where a high switching frequency is necessary. Furthermore, optocouplers do not contain any moving parts and are therefore bounce-free, immune to vibrations and possess a long electrical life.

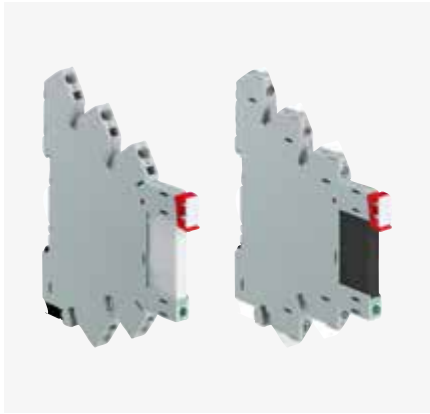

CR-S range

The slim line of interface relays and optocouplers

The pluggable interface relays and optocouplers of the CR-S range are used for electrical isolation, amplification and signal matching between the electronic controlling, e.g. PLC, iPC or field bus systems and the sensor / actuator level. The CR-S range combines the flexibility of a modular system and the ability of switching high currents on a small footprint thus can be used in applications where space saving is essential. The CR-S range also includes complete versions consisting of a relay, socket and marker.



CR-P range

The pluggable pcb interface relays and optocouplers

The pluggable interface relays of the CR-P range are used for electrical isolation, amplification and signal matching between the electronic controlling, e.g. PLC, iPC or field bus systems and the sensor / actuator level. The CR-P range offers highest current switching in an IP67 rated relay housing. Furthermore, nine different coil voltages are available to suit world wide applications and even gold contact versions are available which is essential when it comes to switch sensitive signals. The CR-P range also includes complete versions consisting of a relay, socket, holder, marker and function module.

Interface relays and optocouplers

Offer overview



CR-M range

The pluggable miniature interface relays

The pluggable interface relays of the CR-M range are used for electrical isolation, amplification and signal matching between the electronic controlling, e.g. PLC, iPC or field bus systems and the sensor / actuator level. The CR-M range offers up to 4 contacts in one relay and a built in test button which makes a circuit check fast and easy. 12 different coil voltages are available to suit world wide applications and even gold contact versions are available which is essential when it comes to switch sensitive signals. The CR-M range also includes complete versions consisting of a relay, socket, holder, marker and where applicable a function module.



CR-U range

The pluggable universal interface relays

The pluggable interface relays of the CR-U range are used for electrical isolation, amplification and signal matching between the electronic controlling, e.g. PLC, iPC or field bus systems and the sensor / actuator level. The CR-U range offers up to 3 contacts in one relay and a built in test button which makes a circuit check fast and easy. 12 different coil voltages are available to suit world wide applications.



R600 range

Boxed interface relays and optocouplers

Boxed interface relays of the R600 range are used for electrical isolation, amplification and signal matching between the electronic controlling, e.g. PLC, iPC or field bus systems and the sensor / actuator level. The relay itself is built in thus the perfect solution because this design fulfills highest vibration requirements. The compact design and different connection terminal possibilities further optimize your panel installation.



Applications of interface relays

A proven technology used worldwide

Relays are universally applicable and are utilized in a diverse array of applications. They are a significant element in contemporary industrial processes and are used in applications where galvanic isolation, signal separation, voltage coupling and signal amplification are required.

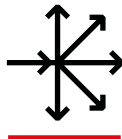

Circuit multiplication

A single voltage signal may be used to simultaneously perform up to four different switching operations. Each output contact can be used to switch load circuits with different voltage and current levels.

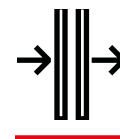

Galvanic isolation

Interface relays are excellently suited to ensure safe galvanic isolation, i.e. separation between control circuit and load circuit.

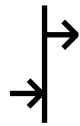

Voltage conversion

Interface relays allow for small voltage signals to switch much larger loads. For example: a 24 V DC 10 mA signal can be used to switch a 230 V AC 16 A load.

Billions
of relays operate and interface
between control circuits and electrical
loads.

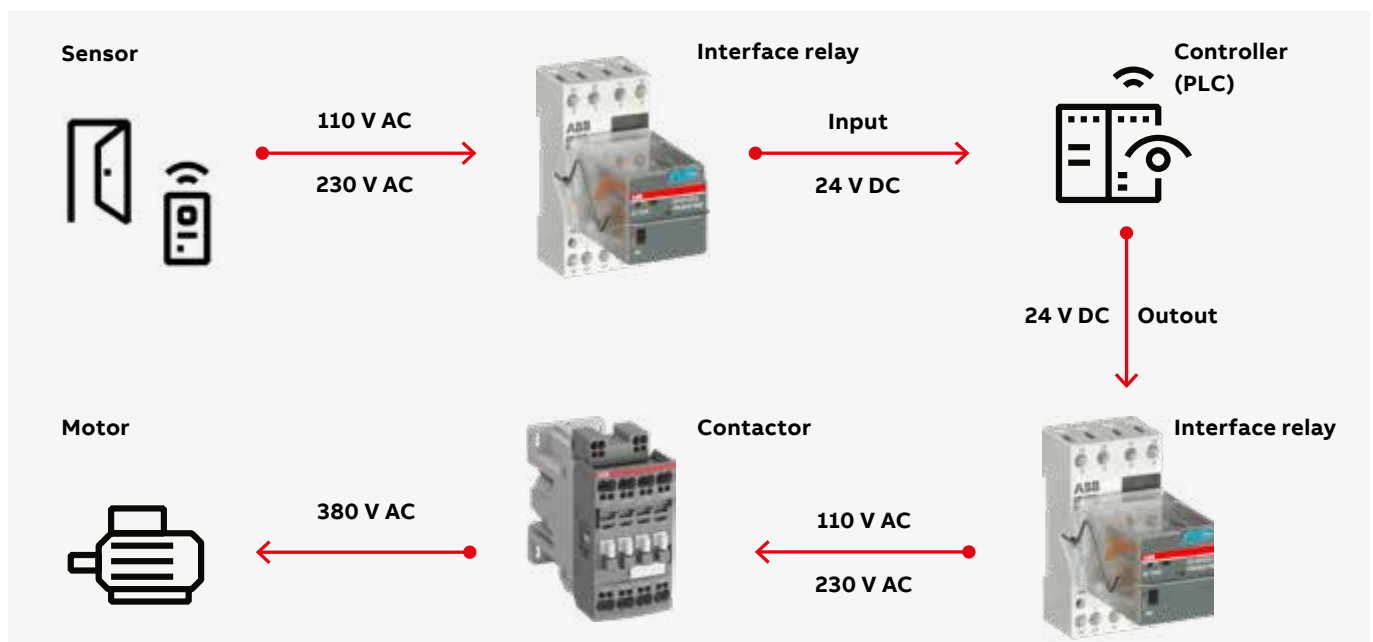



Pluggable interface relays and optocouplers

Table of contents

408	Selection tables
410	List of components
425	Benefits and advantages
426	Socket & terminal connection types
427	Relay components
429	Ordering details –
429	CR-S range
433	CR-P range
437	CR-M range
444	CR-P/M function modules
446	CR-U range
448	CR-U function modules
450	Technical data
450	CR-S interface relays
451	CR-S optocouplers
452	CR-S sockets
453	CR-S jumper bars
454	CR-P, CR-M, CR-U
458	CR-P optocouplers
459	CR-P and CR-M sockets
460	CR-P and CR-M jumper bars
461	CR-P and CR-M function modules
462	CR-U sockets and function modules
462	CR-U function modules
464	Technical diagrams

Pluggable interface relays

Selection table CR-S range



How to use the selection table

Choose the desired control supply voltage from the column "Control voltage", e.g. "5 V DC".

Choose the desired kind of connection terminal from the column "Connection terminal", e.g. "spring".

Choose the desired material of contact from the column "Contact Material" e.g. "gold plated".

Control voltage	Connection terminal	Contact material	Socket type	Socket order code	Relay type	Relay order code
5 V DC	screw	standard	CR-S006/024VDC1SS	1SVR405521R1100	CR-S005VDC1R	1SVR405501R1010
		gold plated	CR-S006/024VDC1SS	1SVR405521R1100	CR-S005VDC1RG	1SVR405501R1020
	spring	standard	CR-S006/024VDC1SZ	1SVR405521R1200	CR-S005VDC1R	1SVR405501R1010
		gold plated	CR-S006/024VDC1SZ	1SVR405521R1200	CR-S005VDC1RG	1SVR405501R1020
12 V AC	screw	standard	CR-S012/024VADC1SS	1SVR405521R3100	CR-S012VDC1R	1SVR405501R2010
		gold plated	CR-S012/024VADC1SS	1SVR405521R3100	CR-S012VDC1RG	1SVR405501R2020
	spring	standard	CR-S012/024VADC1SZ	1SVR405521R3200	CR-S012VDC1R	1SVR405501R2010
		gold plated	CR-S012/024VADC1SZ	1SVR405521R3200	CR-S012VDC1RG	1SVR405501R2020



Example

When you have chosen 5 V DC as control supply voltage, spring connection as connection terminal and gold plated as contact material the following order codes and type designators are valid:

Socket: CR-S006/024VDC1SZ, 1SVR405521R1200

Relay: CR-S005VDC1RG, 1SVR405501R1020

CR-S range relay assemblies

Control voltage	Connection terminal	Contact material	Socket type	Socket order code	Relay type	Relay order code
5 V DC	screw	standard	CR-S006/024VDC1SS	1SVR405521R1100	CR-S005VDC1R	1SVR405501R1010
		gold plated	CR-S006/024VDC1SS	1SVR405521R1100	CR-S005VDC1RG	1SVR405501R1020
	spring	standard	CR-S006/024VDC1SZ	1SVR405521R1200	CR-S005VDC1R	1SVR405501R1010
		gold plated	CR-S006/024VDC1SZ	1SVR405521R1200	CR-S005VDC1RG	1SVR405501R1020
12 V DC	screw	standard	CR-S006/024VDC1SS or CR-S012/024VADC1SS	1SVR405521R1100 or 1SVR405521R3100	CR-S012VDC1R	1SVR405501R2010
		gold plated	CR-S006/024VDC1SS or CR-S012/024VADC1SS	1SVR405521R1100 or 1SVR405521R3100	CR-S012VDC1RG	1SVR405501R2020
	spring	standard	CR-S006/024VDC1SZ or CR-S012/024VADC1SZ	1SVR405521R1200 or 1SVR405521R3200	CR-S012VDC1R	1SVR405501R2010
		gold plated	CR-S006/024VDC1SZ or CR-S012/024VADC1SZ	1SVR405521R1200 or 1SVR405521R3200	CR-S012VDC1RG	1SVR405501R2020
12 V AC	screw	standard	CR-S012/024VADC1SS	1SVR405521R3100	CR-S012VDC1R	1SVR405501R2010
		gold plated	CR-S012/024VADC1SS	1SVR405521R3100	CR-S012VDC1RG	1SVR405501R2020
	spring	standard	CR-S012/024VADC1SZ	1SVR405521R3200	CR-S012VDC1R	1SVR405501R2010
		gold plated	CR-S012/024VADC1SZ	1SVR405521R3200	CR-S012VDC1RG	1SVR405501R2020
24 V DC	screw	standard	CR-S006/024VDC1SS or CR-S012/024VADC1SS	1SVR405521R1100 or 1SVR405521R3100	CR-S024VDC1R	1SVR405501R3010
		gold plated	CR-S006/024VDC1SS or CR-S012/024VADC1SS	1SVR405521R1100 or 1SVR405521R3100	CR-S024VDC1RG	1SVR405501R3020
	spring	standard	CR-S006/024VDC1SZ or CR-S012/024VADC1SZ	1SVR405521R1200 or 1SVR405521R3200	CR-S024VDC1R	1SVR405501R3010
		gold plated	CR-S006/024VDC1SZ or CR-S012/024VADC1SZ	1SVR405521R1200 or 1SVR405521R3200	CR-S024VDC1RG	1SVR405501R3020
24 V AC	screw	standard	CR-S012/024VADC1SS	1SVR405521R3100	CR-S024VDC1R	1SVR405501R3010
		gold plated	CR-S012/024VADC1SS	1SVR405521R3100	CR-S024VDC1RG	1SVR405501R3020
	spring	standard	CR-S012/024VADC1SZ	1SVR405521R3200	CR-S024VDC1R	1SVR405501R3010
		gold plated	CR-S012/024VADC1SZ	1SVR405521R3200	CR-S024VDC1RG	1SVR405501R3020
48 V AC/DC	screw	standard	CR-S048/060VADC1SS	1SVR405521R5100	CR-S048VDC1R	1SVR405501R4010
		gold plated	CR-S048/060VADC1SS	1SVR405521R5100	CR-S048VDC1RG	1SVR405501R4020
	spring	standard	CR-S048/060VADC1SZ	1SVR405521R5200	CR-S048VDC1R	1SVR405501R4010
		gold plated	CR-S048/060VADC1SZ	1SVR405521R5200	CR-S048VDC1RG	1SVR405501R4020
60 V AC/DC	screw	standard	CR-S048/060VADC1SS	1SVR405521R5100	CR-S060VDC1R	1SVR405501R5010
		gold plated	CR-S048/060VADC1SS	1SVR405521R5100	CR-S060VDC1RG	1SVR405501R5020
	spring	standard	CR-S048/060VADC1SZ	1SVR405521R5200	CR-S060VDC1R	1SVR405501R5010
		gold plated	CR-S048/060VADC1SZ	1SVR405521R5200	CR-S060VDC1RG	1SVR405501R5020
110-125 V AC/DC	screw	standard	CR-S110/125VADC1SS	1SVR405521R6100	CR-S060VDC1R	1SVR405501R5010
		gold plated	CR-S110/125VADC1SS	1SVR405521R6100	CR-S060VDC1RG	1SVR405501R5020
	spring	standard	CR-S110/125VADC1SZ	1SVR405521R6200	CR-S060VDC1R	1SVR405501R5010
		gold plated	CR-S110/125VADC1SZ	1SVR405521R6200	CR-S060VDC1RG	1SVR405501R5020
220-240 V AC/DC	screw	standard	CR-S220/240VADC1SS	1SVR405521R7100	CR-S060VDC1R	1SVR405501R5010
		gold plated	CR-S220/240VADC1SS	1SVR405521R7100	CR-S060VDC1RG	1SVR405501R5020
	spring	standard	CR-S220/240VADC1SZ	1SVR405521R7200	CR-S060VDC1R	1SVR405501R5010
		gold plated	CR-S220/240VADC1SZ	1SVR405521R7200	CR-S060VDC1RG	1SVR405501R5020

CR-S optocoupler range relay assemblies

Control voltage	Connection terminal	Output characteristics	Socket type	Socket order code	Opto type	Opto order code
24 V DC	screw	Transistor 100 mA - 48 V DC	CR-S012/024VADC1SS	1SVR405521R3100	CR-S024VDC1TRA	1SVR405510R3050
			CR-S012/024VADC1SZ	1SVR405521R3200	CR-S024VDC1TRA	1SVR405510R3050
	spring	MOS-FET 2 A - 24 V DC	CR-S012/024VADC1SS	1SVR405521R3100	CR-S024VDC1MOS	1SVR405510R3060
			CR-S012/024VADC1SZ	1SVR405521R3200	CR-S024VDC1MOS	1SVR405510R3060
	screw	Triac 2 A - 240 V AC	CR-S012/024VADC1SS	1SVR405521R3100	CR-S024VDC1TRI	1SVR405510R3070
			CR-S012/024VADC1SZ	1SVR405521R3200	CR-S024VDC1TRI	1SVR405510R3070

Pluggable interface relays and optocouplers

Selection table CR-M range

CR-M pluggable relays with LED

Type	Order code
CR-M012DC4L	1SVR405613R4100
CR-M012DC4LD	1SVR405613R4400
CR-M024DC4L	1SVR405613R1100
CR-M024DC4LD	1SVR405614R1100
CR-M048DC4L	1SVR405613R6100
CR-M048DC4LD	1SVR405613R6400
CR-M060DC4L	1SVR405613R4300
CR-M110DC4L	1SVR405613R8100
CR-M110DC4LD	1SVR405613R8400
CR-M125DC4L	1SVR405613R8300
CR-M125DC4LD	1SVR405613R8500
CR-M220DC4L	1SVR405613R9100
CR-M220DC4LD	1SVR405613R9400
CR-M012AC4L	1SVR405613R0300
CR-M024AC4L	1SVR405613R0100
CR-M048AC4L	1SVR405613R5100
CR-M110AC4L	1SVR405613R7100
CR-M120AC4L	1SVR405613R2100
CR-M230AC4L	1SVR405613R3100

Control voltage	CR-M012DC4L	CR-M012DC4LD	CR-M024DC4L	CR-M024DC4LD	CR-M048DC4L	CR-M048DC4LD	CR-M060DC4L	CR-M110DC4L	CR-M110DC4LD	CR-M125DC4L	CR-M125DC4LD	CR-M220DC4L	CR-M220DC4LD	CR-M012AC4L	CR-M024AC4L	CR-M048AC4L	CR-M110AC4L	CR-M120AC4L	CR-M230AC4L	
12 V DC	■	■																		
24 V DC			■	■																
48 V DC					■	■														
60 V DC							■													
110 V DC								■	■											
125 V DC										■	■									
220 V DC												■	■							
12 V AC														■						
24 V AC															■					
48 V AC																■				
60 V AC																	■			
110 V AC																		■		
120 V AC																			■	
230 V AC																				■

Output rating	CR-M012DC4L	CR-M012DC4LD	CR-M024DC4L	CR-M024DC4LD	CR-M048DC4L	CR-M048DC4LD	CR-M060DC4L	CR-M110DC4L	CR-M110DC4LD	CR-M125DC4L	CR-M125DC4LD	CR-M220DC4L	CR-M220DC4LD	CR-M012AC4L	CR-M024AC4L	CR-M048AC4L	CR-M110AC4L	CR-M120AC4L	CR-M230AC4L	
250 V AC 6 A	■	■	■	■	■	■	■	■	■	■	■	■	■	■	■	■	■	■	■	■
250 V AC 10 A																				
250 V AC 12 A																				

Output contacts	CR-M012DC4L	CR-M012DC4LD	CR-M024DC4L	CR-M024DC4LD	CR-M048DC4L	CR-M048DC4LD	CR-M060DC4L	CR-M110DC4L	CR-M110DC4LD	CR-M125DC4L	CR-M125DC4LD	CR-M220DC4L	CR-M220DC4LD	CR-M012AC4L	CR-M024AC4L	CR-M048AC4L	CR-M110AC4L	CR-M120AC4L	CR-M230AC4L
c/o	4	4	4	4	4	4	4	4	4	4	4	4	4	4	4	4	4	4	4
Gold plated contacts																			

Additional features	CR-M012DC4L	CR-M012DC4LD	CR-M024DC4L	CR-M024DC4LD	CR-M048DC4L	CR-M048DC4LD	CR-M060DC4L	CR-M110DC4L	CR-M110DC4LD	CR-M125DC4L	CR-M125DC4LD	CR-M220DC4L	CR-M220DC4LD	CR-M012AC4L	CR-M024AC4L	CR-M048AC4L	CR-M110AC4L	CR-M120AC4L	CR-M230AC4L
LED	■	■	■	■	■	■	■	■	■	■	■	■	■	■	■	■	■	■	■
Free-wheeling diode		■		■		■			■		■		■						

Pluggable interface relays and optocouplers

Selection table CR-M range

CR-M pluggable relays with Gold Plated Contacts

Type	Order code
CR-M024DC4G	1SVR405618R1000
CR-M024AC4G	1SVR405618R0000
CR-M110AC4G	1SVR405618R7000
CR-M230AC4G	1SVR405618R3000
CR-M230AC4G	1SVR405618R3000
CR-M012DC4LG	1SVR405618R4100
CR-M024DC4LG	1SVR405618R1100
CR-M048DC4LG	1SVR405618R6100
CR-M060DC4LG	1SVR405618R4300
CR-M110DC4LG	1SVR405618R8100
CR-M125DC4LG	1SVR405618R8300
CR-M220DC4LG	1SVR405618R9100
CR-M024AC4LG	1SVR405618R0100
CR-M048AC4LG	1SVR405618R5100
CR-M110AC4LG	1SVR405618R7100
CR-M120AC4LG	1SVR405618R2100
CR-M230AC4LG	1SVR405618R3100
CR-M012DC4LDG	1SVR405618R4400
CR-M024DC4LDG	1SVR405618R1400

Control voltage	
12 V DC	■
24 V DC	■
48 V DC	■
60 V DC	■
110 V DC	■
125 V DC	■
220 V DC	■
24 V AC	■
48 V AC	■
60 V AC	■
110 V AC	■
120 V AC	■
230 V AC	■

Output rating	
250 V AC 6 A	■
250 V AC 10 A	■
250 V AC 12 A	■

Output contacts	
c/o	4 4 4 4 4 4 4 4 4 4 4 4 4 4 4 4 4 4
Gold plated contacts	■ ■ ■ ■ ■ ■ ■ ■ ■ ■ ■ ■ ■ ■ ■ ■ ■ ■ ■ ■

Additional features	
LED	■ ■ ■ ■ ■ ■ ■ ■ ■ ■ ■ ■ ■ ■ ■ ■ ■ ■ ■ ■
Free-wheeling diode	■ ■

Pluggable interface relays and optocouplers

Selection table CR-M range complete versions

CR-M range complete versions

	Type	Order code
	CR-M012DC4LDGSS	15VR405618R4410
	CR-M024DC4SS42V	15VR405613R1010
	CR-M024DC4LS42V	15VR405613R1011
	CR-M024DC4LC42	15VR405613R1012
	CR-M024DC4GSS42V	15VR405618R1011
	CR-M024DC4GLC62CV	15VR405618R1010
	CR-M024DC4LGLC22	15VR405618R1110
	CR-M024DC4LDGSS	15VR405618R1410
	CR-M024AC4LS62CV	15VR405613R0010
	CR-M230AC4SS92CV	15VR405613R3110
	CR-M230AC4LS92CV	15VR405613R3011
	CR-M230AC4LC92	15VR405613R3012
	CR-M230AC4GSS92CV	15VR405618R3112
	CR-M230AC4LGLC	15VR405618R3110
	CR-M230AC4LGSS	15VR405618R3111

Control voltage	
12 V DC	■
24 V DC	■ ■ ■ ■ ■ ■ ■
48 V DC	
60 V DC	
110 V DC	
125 V DC	
220 V DC	
24 V AC	■
48 V AC	
60 V AC	
110 V AC	
120 V AC	
230 V AC	■ ■ ■ ■ ■ ■ ■

Output rating	
250 V AC 6 A	■ ■ ■ ■ ■ ■ ■ ■ ■ ■ ■ ■ ■ ■ ■ ■ ■
250 V AC 10 A	
250 V AC 12 A	

Output contacts	
c/o	4 4 4 4 4 4 4 4 4 4 4 4 4 4 4 4
Gold plated contacts	■ ■ ■ ■ ■ ■ ■ ■ ■ ■ ■ ■ ■ ■ ■ ■ ■

Socket type	
Standard socket	■ ■ ■ ■ ■ ■ ■ ■ ■ ■ ■ ■ ■ ■ ■ ■ ■
Logical socket	■ ■ ■ ■ ■ ■ ■ ■ ■ ■ ■ ■ ■ ■ ■ ■ ■

Additional features	
LED	■ ■ ■ ■ ■ ■ ■ ■ ■ ■ ■ ■ ■ ■ ■ ■ ■
Free-wheeling diode	■ ■ ■ ■ ■ ■ ■ ■ ■ ■ ■ ■ ■ ■ ■ ■ ■

List of components

Selection table CR-M range complete versions



The complete versions of the CR-M range comprise of a pluggable interface relay, socket, holder, marker and where applicable a function module.

CR-M complete versions

Complete versions		Relay	Socket	Function module	Holder
Order code	Type	Order code	Order code	Order code	Order code
1SVR405618R4410	CR-M012DC4LDGSS	1SVR405618R4400	CR-M012DC4LDG	1SVR405651R0000	1SVR405659R1000
1SVR405613R1010	CR-M024DC4SS42V	1SVR405613R1000	CR-M024DC4	1SVR405652R0000	
1SVR405613R1011	CR-M024DC4LS42V	1SVR405618R1000	CR-M024DC4G	1SVR405652R1000	
1SVR405613R1012	CR-M024DC4LC42	1SVR405618R1100	CR-M024DC4LG	1SVR405652R9100	
1SVR405618R1011	CR-M024DC4GSS42V	1SVR405618R1400	CR-M024DC4LDG	1SVR405655R1000	
1SVR405618R1010	CR-M024DC4GLC62CV	1SVR405613R0000	CR-M024AC4	1SVR405654R0100	
1SVR405618R1110	CR-M024DC4LGLC22	1SVR405613R3000	CR-M230AC4	1SVR405655R1100	
1SVR405618R1410	CR-M024DC4LDGSS	1SVR405618R3000	CR-M230AC4G		
1SVR405613R0010	CR-M024AC4LS62CV	1SVR405618R3100	CR-M230AC4LG		
1SVR405613R3110	CR-M230AC4SS92CV	1SVR405618R3200			
1SVR405613R3011	CR-M230AC4LS92CV	1SVR405651R3000	CR-M4SS		
1SVR405613R3012	CR-M230AC4LC92	1SVR405651R3100	CR-M4LS		
1SVR405618R3112	CR-M230AC4GSS92CV	1SVR405651R3200	CR-M4LC		
1SVR405618R3110	CR-M230AC4LGLC	1SVR405651R0000	CR-P/M 22		
1SVR405618R3111	CR-M230AC4LGSS	1SVR405652R0000	CR-P/M 42		
		1SVR405652R1000	CR-P/M 42V		
		1SVR405652R9100	CR-P/M 42CV		
		1SVR405655R1000	CR-P/M 62CV		
		1SVR405654R0100	CR-P/M 92		
		1SVR405655R1100	CR-P/M 92CV		
			CR-MH		

Pluggable interface relays and optocouplers

Selection table CR-U function modules

CR-U function modules

	Type	Order code
	CR-U 21	1SVR405661R0000
	CR-U 41	1SVR405662R0000
	CR-U 41V	1SVR405662R1000
	CR-U 41B	1SVR405662R4000
	CR-U 41BV	1SVR405662R4100
	CR-U 41C	1SVR405662R9000
	CR-U 41CV	1SVR405662R9100
	CR-U 51B	1SVR405663R0000
	CR-U 51D	1SVR405663R4000
	CR-U 51C	1SVR405663R1000
	CR-U 61	1SVR405664R0000
	CR-U 61V	1SVR405664R1000
	CR-U 61E	1SVR405664R4000
	CR-U 61EV	1SVR405664R4100
	CR-U 91	1SVR405664R0100
	CR-U 91V	1SVR405664R1100
	CR-U 61C	1SVR405665R0000
	CR-U 61CV	1SVR405665R1000
	CR-U 61D	1SVR405665R4000
	CR-U 61DV	1SVR405665R4100
	CR-U 91C	1SVR405665R0100
	CR-U 91CV	1SVR405665R1100
	CR-U 71	1SVR405666R0000
	CR-U 71A	1SVR405666R1000
	CR-U 81	1SVR405666R2000
	CR-U T	1SVR405677R0000
Control voltage		
6-220 V DC		■
6-24 V DC	■	■
24-60 V DC	■	■
110 V DC	■	■
110-230 V DC	■	■
6-24 V AC	■	■
24-60 V AC	■	■
110-230 V AC	■	■
24 V AC	■	■
115 V AC	■	■
230 V AC	■	■
24-240 V AC/DC	■	■
Function		
Diode - Reverse polarity protection / free wheeling diode	■	
Diode and LED - Reverse polarity protection / free-wheeling diode and LED to indicate energized coil	■	■
RC element - Spark quenching		■
Diode and LED - LED to indicate energized coil		■
Varistor and LED - Overvoltage protection and LED to indicate energized coil		■
Varistor - Overvoltage protection		■
Multi-function time module		■
LED red	■	■
LED green	■	■

Pluggable interface relays and optocouplers

Benefits and advantages



ABB's interface relays and optocouplers ensure a reliable voltage conversion between process peripherals and higher level control systems. These relays ensure reliable signal switching and provide electrical isolation for sensitive electronics such as PLCs. The wide variety of pluggable interface relays with accompanied by standard or logic sockets may be used for switching AC or DC loads. Suitable for extreme environments, ABB's interface relays are offered across a wide spectrum of coil voltages, with a variety of optional function modules.

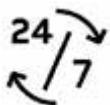

Continuous operation

The interface relay portfolio incorporates a large assortment of relays. It includes both electro-mechanical relays and optocouplers. Optocouplers allow for continuous operation without any mechanical wear-and-tear.



Easy to install

The interface relay includes both pluggable and non-pluggable relays. The pluggable relays allow for the easy and seamless exchange of relay modules.



Global availability

The ABB interface relays and optocouplers are approved for a large variety of applications, comply to the highest global approvals and are available world-wide.

Pluggable interface relays and optocouplers

Socket and terminal connection types

Standard sockets



01 Standard socket CR-P

2CDC291040F0004



02 Standard socket CR-M

2CDC29100950011

Position of connection terminals:
 Coil connection (A1-A2) on lower side of the socket, contact connections (n/o and n/c contacts) on the lower and upper side of the socket.

Logical sockets



03 Logical socket CR-P

2CDC29100650011



04 Logical socket CR-M

2CDC291042F0004

Position of connection terminals:
 Coil connection (A1-A2) on lower side of the socket, all contact connections (common contacts, n/o and n/c contacts) on the upper side of the socket.

Terminal connection types

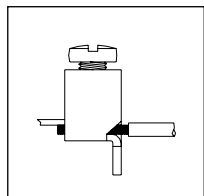

05 Screw type

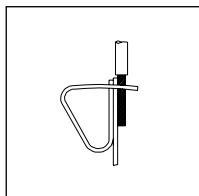

06 Spring type

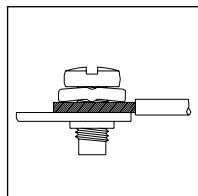

07 Fork type

A variety of sockets are available for interface relays and optocouplers to meet the needs of different applications such as vibration-intensive environments.

Pluggable interface relays and optocouplers

Relay components

CR-S range

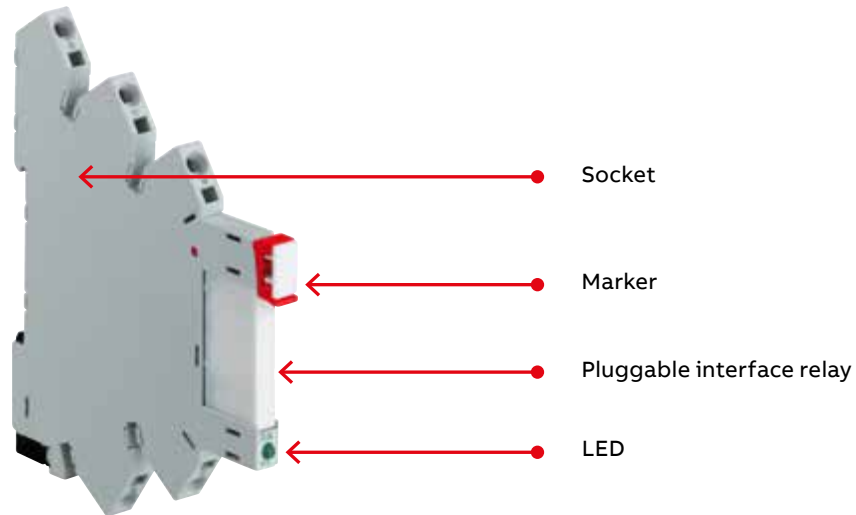

CR-P range

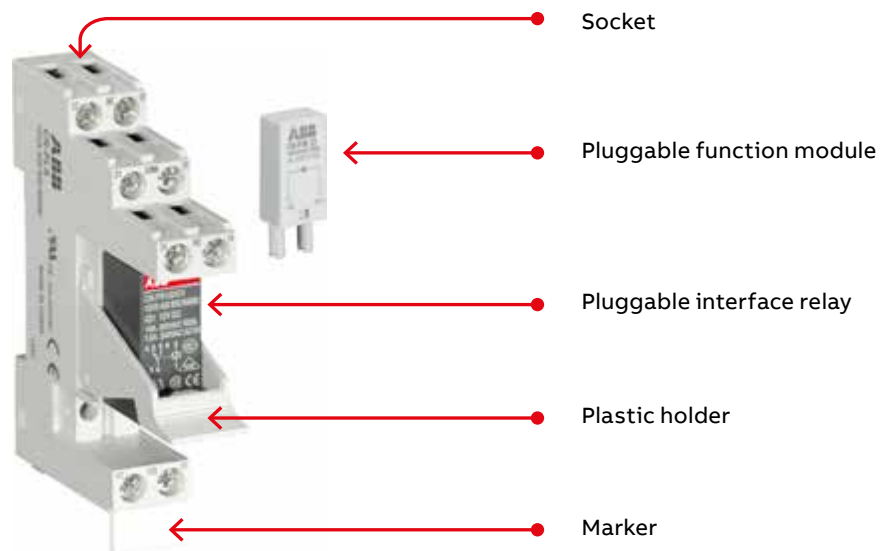

Pluggable interface relays and optocouplers

Relay components

CR-M range

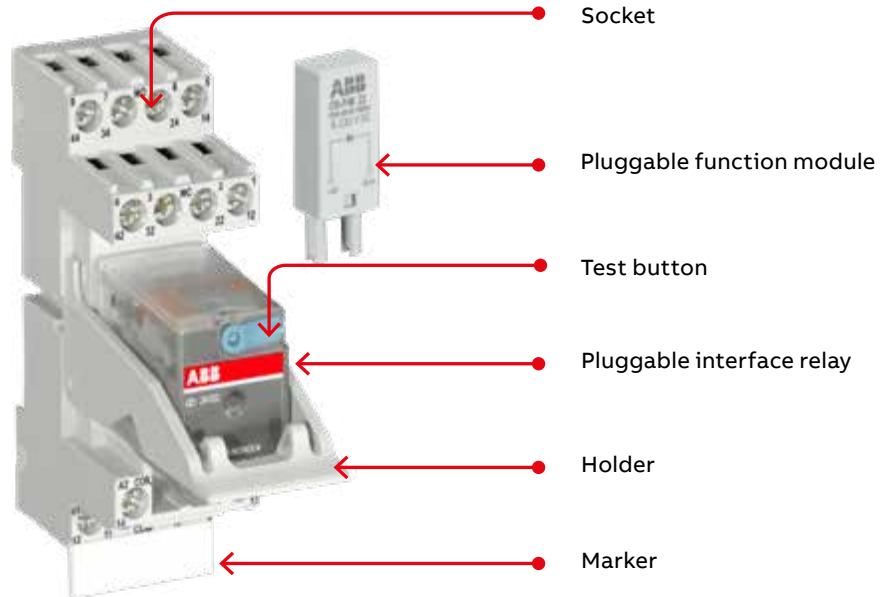

CR-U range

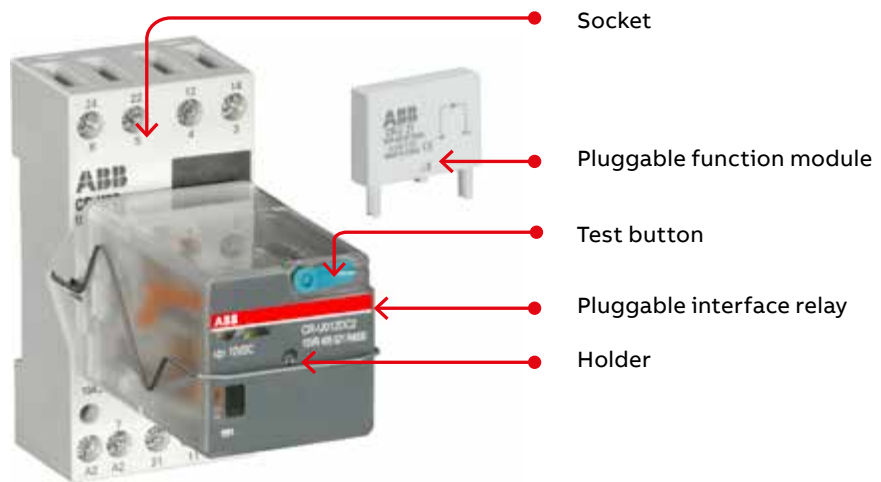

Pluggable interface relays and optocouplers

Ordering details – CR-S range



CR-S relay

2CDC292008F0016

The slim pluggable interface relays and optocouplers of the CR-S range may be used for electrical isolation, amplification and signal matching. The CR-S relays are 6.2 mm wide and therefore allow for the switching high currents on a small footprint.

Ordering details - CR-S range pluggable interface relays

Rated control supply voltage	Outputs	Contact ratings	Type	Order code	Pkg qty	Weight (1 pc.) kg (lb)
5 V DC	1 c/o (SPDT) standard contacts	250 V AC, 6 A	CR-S005VDC1R	1SVR405501R1010	10	0.005 (0.011)
12 V DC			CR-S012VDC1R	1SVR405501R2010		
24 V DC			CR-S024VDC1R	1SVR405501R3010		
48 V DC			CR-S048VDC1R	1SVR405501R4010		
60 V DC			CR-S060VDC1R	1SVR405501R5010		
5 V DC	1 c/o (SPDT) gold plated contacts	12 V, 250 mA (3W) ¹⁾	CR-S005VDC1RG	1SVR405501R1020	10	0.005 (0.011)
12 V DC			CR-S012VDC1RG	1SVR405501R2020		
24 V DC			CR-S024VDC1RG	1SVR405501R3020		
48 V DC			CR-S048VDC1RG	1SVR405501R4020		
60 V DC			CR-S060VDC1RG	1SVR405501R5020		

Ordering details - CR-S range pluggable optocouplers

Rated control supply voltage	Outputs	Type	Order code	Pkg qty	Weight (1 pc.) kg (lb)
24 V DC	Transistor, 100 mA - 48 V DC	CR-S024VDC1TRA	1SVR405510R3050	10	0.004 (0.009)
	MOS-FET, 2 A - 24 V DC	CR-S024VDC1MOS	1SVR405510R3060		
	Triac, 2 A - 240 V AC	CR-S024VDC1TRI	1SVR405510R3070		



CR-S optocoupler

2CDC29100350016

Ordering details - CR-S range complete interface relays (relay + socket)

Rated control supply voltage	Outputs	Contact ratings	Type	Order code	Pkg qty	Weight (1 pc.) kg (lb)
24 V AC/DC	1 c/o (SPDT) standard contacts	250 V AC, 6 A	CR-S012VADC1CRS	1SVR405541R2110	10	0.03 (0.066)
			CR-S012VADC1CRZ	1SVR405541R2210		
			CR-S024VADC1CRS	1SVR405541R3110		
			CR-S024VADC1CRZ	1SVR405541R3210		
			CR-S110VADC1CRS	1SVR405541R6110		
110 V AC/DC			CR-S110VADC1CRZ	1SVR405541R6210		
			CR-S230VADC1CRS	1SVR405541R7110		
230 V AC/DC			CR-S230VADC1CRZ	1SVR405541R7210		
24 V AC/DC	1 c/o (SPDT) gold plated contacts	12 V, 250 mA (3W) ¹⁾	CR-S024VADC1CRGS	1SVR405541R3120	10	0.03 (0.066)
			CR-S024VADC1CRGZ	1SVR405541R3220		
110 V AC/DC			CR-S110VADC1CRGS	1SVR405541R6120		
			CR-S110VADC1CRGZ	1SVR405541R6220		
230 V AC/DC			CR-S230VADC1CRGS	1SVR405541R7120		
			CR-S230VADC1CRGZ	1SVR405541R7220		



CR-S complete interface relay

2CDC29100550014

¹⁾ If specified maximum values exceeded, the gold plating is destroyed. The maximum values of the standard contacts are then valid.

Pluggable interface relays and optocouplers

Ordering details – CR-S range



CR-S socket

2CDC292008F0016

Ordering details - CR-S range sockets

Rated control supply voltage	Connection type	Type	Order code	Pkg qty	Weight (1 pc.) kg (lb)
6-24 V DC	screw	CR-S006/024VDC1SS	1SVR405521R1100	10	0.025 (0.055)
	spring	CR-S006/024VDC1SZ	1SVR405521R1200		
12-24 V AC/DC	screw	CR-S012/024VADC1SS	1SVR405521R3100		
	spring	CR-S012/024VADC1SZ	1SVR405521R3200		
48-60 V AC/DC	screw	CR-S048/060VADC1SS	1SVR405521R5100		
	spring	CR-S048/060VADC1SZ	1SVR405521R5200		
110-125 V AC/DC	screw	CR-S110/125VADC1SS	1SVR405521R6100		
	spring	CR-S110/125VADC1SZ	1SVR405521R6200		
220-240 V AC/DC	screw	CR-S220/240VADC1SS	1SVR405521R7100		
	spring	CR-S220/240VADC1SZ	1SVR405521R7200		

Ordering details - CR-S range accessories

Version	Type	Order code	Pkg qty	Weight (1 pc.) kg (lb)
Jumper bar 20 pole, blue color	CR-SJB20-BLUE	1SVR405598R0700	10	0.008 (0.018)
Jumper bar 20 pole, red color	CR-SJB20-RED	1SVR405598R0800		
Jumper bar 20 pole, black color	CR-SJB20-BLACK	1SVR405598R0900		
Separator	CR-SSEP	1SVR405599R0000	10	0.012 (0.026)

Pluggable interface relays and optocouplers

Ordering details – CR-S range

Relay assemblies

Control voltage	Connection terminal	Contact material	Socket type	Socket order code	Relay type	Relay order code
5 V DC	screw	standard	CR-S006/024VDC1SS	1SVR405521R1100	CR-S005VDC1R	1SVR405501R1010
		gold plated	CR-S006/024VDC1SS	1SVR405521R1100	CR-S005VDC1RG	1SVR405501R1020
	spring	standard	CR-S006/024VDC1SZ	1SVR405521R1200	CR-S005VDC1R	1SVR405501R1010
		gold plated	CR-S006/024VDC1SZ	1SVR405521R1200	CR-S005VDC1RG	1SVR405501R1020
12 V DC	screw	standard	CR-S006/024VDC1SS or CR-S012/024VADC1SS	1SVR405521R1100 or 1SVR405521R3100	CR-S012VDC1R	1SVR405501R2010
		gold plated	CR-S006/024VDC1SS or CR-S012/024VADC1SS	1SVR405521R1100 or 1SVR405521R3100	CR-S012VDC1RG	1SVR405501R2020
	spring	standard	CR-S006/024VDC1SZ or CR-S012/024VADC1SZ	1SVR405521R1200 or 1SVR405521R3200	CR-S012VDC1R	1SVR405501R2010
		gold plated	CR-S006/024VDC1SZ or CR-S012/024VADC1SZ	1SVR405521R1200 or 1SVR405521R3200	CR-S012VDC1RG	1SVR405501R2020
12 V AC	screw	standard	CR-S012/024VADC1SS	1SVR405521R3100	CR-S012VDC1R	1SVR405501R2010
		gold plated	CR-S012/024VADC1SS	1SVR405521R3100	CR-S012VDC1RG	1SVR405501R2020
	spring	standard	CR-S012/024VADC1SZ	1SVR405521R3200	CR-S012VDC1R	1SVR405501R2010
		gold plated	CR-S012/024VADC1SZ	1SVR405521R3200	CR-S012VDC1RG	1SVR405501R2020
24 V DC	screw	standard	CR-S006/024VDC1SS or CR-S012/024VADC1SS	1SVR405521R1100 or 1SVR405521R3100	CR-S024VDC1R	1SVR405501R3010
		gold plated	CR-S006/024VDC1SS or CR-S012/024VADC1SS	1SVR405521R1100 or 1SVR405521R3100	CR-S024VDC1RG	1SVR405501R3020
	spring	standard	CR-S006/024VDC1SZ or CR-S012/024VADC1SZ	1SVR405521R1200 or 1SVR405521R3200	CR-S024VDC1R	1SVR405501R3010
		gold plated	CR-S006/024VDC1SZ or CR-S012/024VADC1SZ	1SVR405521R1200 or 1SVR405521R3200	CR-S024VDC1RG	1SVR405501R3020
24 V AC	screw	standard	CR-S012/024VADC1SS	1SVR405521R3100	CR-S024VDC1R	1SVR405501R3010
		gold plated	CR-S012/024VADC1SS	1SVR405521R3100	CR-S024VDC1RG	1SVR405501R3020
	spring	standard	CR-S012/024VADC1SZ	1SVR405521R3200	CR-S024VDC1R	1SVR405501R3010
		gold plated	CR-S012/024VADC1SZ	1SVR405521R3200	CR-S024VDC1RG	1SVR405501R3020
48 V AC/DC	screw	standard	CR-S048/060VADC1SS	1SVR405521R5100	CR-S048VDC1R	1SVR405501R4010
		gold plated	CR-S048/060VADC1SS	1SVR405521R5100	CR-S048VDC1RG	1SVR405501R4020
	spring	standard	CR-S048/060VADC1SZ	1SVR405521R5200	CR-S048VDC1R	1SVR405501R4010
		gold plated	CR-S048/060VADC1SZ	1SVR405521R5200	CR-S048VDC1RG	1SVR405501R4020
60 V AC/DC	screw	standard	CR-S048/060VADC1SS	1SVR405521R5100	CR-S060VDC1R	1SVR405501R5010
		gold plated	CR-S048/060VADC1SS	1SVR405521R5100	CR-S060VDC1RG	1SVR405501R5020
	spring	standard	CR-S048/060VADC1SZ	1SVR405521R5200	CR-S060VDC1R	1SVR405501R5010
		gold plated	CR-S048/060VADC1SZ	1SVR405521R5200	CR-S060VDC1RG	1SVR405501R5020
110-125 V AC/DC	screw	standard	CR-S110/125VADC1SS	1SVR405521R6100	CR-S060VDC1R	1SVR405501R5010
		gold plated	CR-S110/125VADC1SS	1SVR405521R6100	CR-S060VDC1RG	1SVR405501R5020
	spring	standard	CR-S110/125VADC1SZ	1SVR405521R6200	CR-S060VDC1R	1SVR405501R5010
		gold plated	CR-S110/125VADC1SZ	1SVR405521R6200	CR-S060VDC1RG	1SVR405501R5020
220-240 V AC/DC	screw	standard	CR-S220/240VADC1SS	1SVR405521R7100	CR-S060VDC1R	1SVR405501R5010
		gold plated	CR-S220/240VADC1SS	1SVR405521R7100	CR-S060VDC1RG	1SVR405501R5020
	spring	standard	CR-S220/240VADC1SZ	1SVR405521R7200	CR-S060VDC1R	1SVR405501R5010
		gold plated	CR-S220/240VADC1SZ	1SVR405521R7200	CR-S060VDC1RG	1SVR405501R5020

Pluggable interface relays and optocouplers

Ordering details – CR-S range

Optocoupler assemblies

Control voltage	Connection terminal	Output characteristics	Socket type	Socket order code	Opto type	Opto order code
24 V DC	screw	Transistor 100 mA - 48 V DC	CR-S012/024VADC1SS	1SVR405521R3100	CR-S024VDC1TRA	1SVR405510R3050
	spring		CR-S012/024VADC1SZ	1SVR405521R3200	CR-S024VDC1TRA	1SVR405510R3050
	screw	MOS-FET 2 A - 24 V DC	CR-S012/024VADC1SS	1SVR405521R3100	CR-S024VDC1MOS	1SVR405510R3060
	spring		CR-S012/024VADC1SZ	1SVR405521R3200	CR-S024VDC1MOS	1SVR405510R3060
	screw	Triac 2 A - 240 V AC	CR-S012/024VADC1SS	1SVR405521R3100	CR-S024VDC1TRI	1SVR405510R3070
	spring		CR-S012/024VADC1SZ	1SVR405521R3200	CR-S024VDC1TRI	1SVR405510R3070

Pluggable interface relays and optocouplers

Ordering details – CR-P range

The CR-P range offers the highest current switching in an IP67 rated relay housing. This range comprises of pluggable interface relays and optocouplers offered in 10 different control supply voltages. Additionally, gold plated contacts are available for applications where sensitive signals are to be switched. The CR-P range also includes complete versions consisting of a relay, socket, holder, marker and function module.



2CDC291.045.F0004

CR-P relay

Ordering details - CR-P range relays

Rated control supply voltage	Outputs	Contact ratings	Type	Order code	Pkg qty	Weight (1 pc.) kg (lb)
12 V DC	1 c/o (SPDT)	250 V AC, 16 A	CR-P012DC1	1SVR405600R4000	10	0.014 (0.031)
24 V DC			CR-P024DC1	1SVR405600R1000		
48 V DC			CR-P048DC1	1SVR405600R6000		
110 V DC			CR-P110DC1	1SVR405600R8000		
24 V AC			CR-P024AC1	1SVR405600R0000		
48 V AC			CR-P048AC1	1SVR405600R5000		
110 V AC			CR-P110AC1	1SVR405600R7000		
120 V AC			CR-P120AC1	1SVR405600R2000		
230 V AC			CR-P230AC1	1SVR405600R3000		
12 V DC			2 c/o (SPDT)	250 V AC, 8 A		
24 V DC	CR-P024DC2	1SVR405601R1000				
48 V DC	CR-P048DC2	1SVR405601R6000				
110 V DC	CR-P110DC2	1SVR405601R8000				
12 V AC	CR-P012AC2	1SVR405601R0200				
24 V AC	CR-P024AC2	1SVR405601R0000				
48 V AC	CR-P048AC2	1SVR405601R5000				
110 V AC	CR-P110AC2	1SVR405601R7000				
120 V AC	CR-P120AC2	1SVR405601R2000				
230 V AC	CR-P230AC2	1SVR405601R3000				

Ordering details - CR-P range relays with gold contacts

Rated control supply voltage	Outputs	Contact ratings	Type	Order code	Pkg qty	Weight (1 pc.) kg (lb)
24 V DC	2 c/o (SPDT) gold contact	250 V AC, 8 A	CR-P024DC2G	1SVR405606R1000	10	0.014 (0.031)
24 V AC			CR-P024AC2G	1SVR405606R0000		
110 V AC			CR-P110AC2G	1SVR405606R7000		
230 V AC			CR-P230AC2G	1SVR405606R3000		

Ordering details - CR-P range pluggable optocouplers

Rated control supply voltage (Us)	Outputs	Type	Order code	Pkg qty	Weight (1 pc.) kg (lb)
10-32 V DC	MOS-FET, 5 A - 35 V DC	CR-P024MOS1	1SVR405610R4060	10	0.011 (0.618)
	Triac, 3 A - 275 V AC	CR-P024TRI1	1SVR405610R4070		



2CDC291.006.S0016

CR-P optocoupler

Pluggable interface relays and optocouplers

Ordering details – CR-P range



CR-PLSX



CR-PSS

Standard and logical sockets for CR-P interface relays are suitable for snap-on mounting onto a DIN rail. Optional function modules for the CR-P range are plugged into both standard and logical sockets.

Ordering details - Sockets*

Version	Connection terminal	Type	Order code	Pkg qty	Weight (1 pc.) kg (lb)
Logical socket with protective separation	screw	CR-PLS	1SVR405650R0000	10	0.045 (0.099)
Logical socket	spring	CR-PLC	1SVR405650R0200		0.042 (0.093)
Standard socket	screw	CR-PSS	1SVR405650R1000		0.038 (0.084)

*All CR-P socket packages include a set of markers.

Standard sockets

Position of connection terminals: coil connection (A1-A2) on lower side of the socket, contact connections (n/o and n/c contacts) on the lower and upper side of the socket.

Logical sockets

Position of connection terminals: coil connection (A1-A2) on lower side of the socket, all contact connections (common contacts, n/o and n/c contacts) on the upper side of the socket.

Ordering details - Accessories

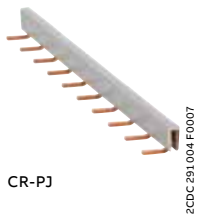

CR-PJ

Version	Type	Order code	Pkg qty	Weight (1 pc.) kg (lb)
Plastic holder for socket	CR-PH	1SVR405659R0000	10	0.002 (0.004)
Metal holder for socket	CR-PH1	1SVR405659R0100		0.4g
Jumper bar for sockets with screw connection	CR-PJ	1SVR405658R5000		0.018 (0.040)
Marker	CR-PM	1SVR405658R0000	10	0.0002 (0.0004)

Pluggable interface relays and optocouplers

Ordering details – CR-P range



CR-P complete version

2CDC291001F0019

Ordering details - CR-P range complete versions

Rated control supply voltage	Out-puts	Description	Socket type	Connection terminal	Type	Order code	Pkg qty	Weight (1 pc.) kg (lb)
12 V DC	1 c/o	Reverse polarity protection and freewheeling diode, LED green, holder	standard	screw	CR-P012DC1SS42V	1SVR405600R4010	10	0.057 (0.126)
24 V DC	1 c/o	Reverse polarity protection and freewheeling diode, LED green, holder	standard	screw	CR-P024DC1SS42V	1SVR405600R1010	10	0.057 (0.126)
		Reverse polarity protection and freewheeling diode, LED green, holder	logical	spring	CR-P024DC1LC42V	1SVR405600R1011	10	0.057 (0.126)
		Varistor and LED red, holder	logical	spring	CR-P024DC1LC62C	1SVR405600R1013	10	0.057 (0.126)
110 V DC	1 c/o	Reverse polarity protection and freewheeling diode, LED green, holder	standard	screw	CR-P110DC1SS42CV	1SVR405600R8010	10	0.057 (0.126)
24 V AC	1 c/o	Varistor and LED green, holder	standard	screw	CR-P024AC1SS62CV	1SVR405600R0010	10	0.057 (0.126)
120 V AC	1 c/o	Varistor and LED green, holder	standard	screw	CR-P120AC1SS92CV	1SVR405600R2010	10	0.057 (0.126)
230 V AC	1 c/o	Reverse polarity protection and freewheeling diode, LED green, holder	standard	screw	CR-P230AC1SS92CV	1SVR405600R3110	10	0.057 (0.126)
		Holder	logical	screw	CR-P230AC1LS	1SVR405600R3011	10	0.057 (0.126)
		Varistor and LED green, holder	logical	spring	CR-P230AC1LC92CV	1SVR405600R3010	10	0.057 (0.126)

Pluggable interface relays and optocouplers

Ordering details – CR-P range



CR-P complete version

2DC291001F0019

Ordering details - CR-P range complete versions

Rated control supply voltage	Out-puts	Description	Socket type	Con-nection terminal	Type	Order code	Pkg qty	Weight (1 pc.) kg (lb)
12 V DC	2 c/o	Reverse polarity protection and freewheeling diode, LED green, holder	standard	screw	CR-P012DC2SS42V	1SVR405601R4010	10	0.057 (0.126)
24 V DC	2 c/o	Reverse polarity protection and freewheeling diode, LED green, holder	standard	screw	CR-P024DC2SS42V	1SVR405601R1010	10	0.057 (0.126)
		Reverse polarity protection and freewheeling diode, LED red, holder	logical	screw	CR-P024DC2LS42	1SVR405601R1013	10	0.057 (0.126)
		Reverse polarity protection and freewheeling diode, LED green, holder	logical	screw	CR-P024DC2LS42V	1SVR405601R1011	10	0.057 (0.126)
		Reverse polarity protection and freewheeling diode, LED red, holder	logical	spring	CR-P024DC2LC42	1SVR405601R1012	10	0.057 (0.126)
24 V DC	2 c/o gold plated	Reverse polarity protection and freewheeling diode, LED green, holder	logical	spring	CR-P024DC2GLC42V	1SVR405606R1010	10	0.057 (0.126)
		Varistor and LED red, holder	logical	spring	CR-P024DC2GLC62C	1SVR405606R1013	10	0.057 (0.126)
		Varistor and LED green, holder	logical	spring	CR-P024DC2GLC62CV	1SVR405606R1011	10	0.057 (0.126)
110 V DC	2 c/o	Reverse polarity protection and freewheeling diode, LED green, holder	standard	screw	CR-P110DC2SS42CV	1SVR405601R8010	10	0.057 (0.126)
24 V AC	2 c/o	Varistor and LED green, holder	standard	screw	CR-P024AC2SS62CV	1SVR405601R0010	10	0.057 (0.126)
120 V AC	2 c/o	Varistor and LED green, holder	standard	screw	CR-P120AC2SS92CV	1SVR405601R2010	10	0.057 (0.126)
230 V AC	2 c/o	Reverse polarity protection and freewheeling diode, LED green, holder	standard	screw	CR-P230AC2SS92CV	1SVR405601R3110	10	0.057 (0.126)
		Varistor and LED green, holder	logical	screw	CR-P230AC2LS92CV	1SVR405601R3011	10	0.057 (0.126)
		Diode and LED red, holder	logical	spring	CR-P230AC2LC92	1SVR405601R3012	10	0.057 (0.126)
230 V AC	2 c/o gold plated	Diode and LED red, holder	logical	spring	CR-P230AC2GLC92	1SVR405606R3013	10	0.057 (0.126)
		Varistor and LED red, holder	logical	spring	CR-P230AC2GLC92C	1SVR405606R3012	10	0.057 (0.126)
		Varistor and LED green, holder	logical	spring	CR-P230AC2GLC92CV	1SVR405606R3010	10	0.057 (0.126)

Pluggable interface relays and optocouplers

Ordering details – CR-M range



CR-M

The CR-M range offers the possibility of switching up to 4 different circuits with a single relay. The integrated LED and test button* allow for easy testing and commissioning. This range of relays are available at a wide range of different coil voltages and are accompanied by a wide variety of function modules. The CR-M range also includes complete versions consisting of a relay, socket, holder, marker and where applicable, function module.

Ordering details - CR-M range without LED

Rated control supply voltage	Outputs	Contact ratings	Type	Order code	Pkg qty	Weight (1 pc.) kg (lb)				
12 V DC	2 c/o (SPDT)	250 V AC, 12 A	CR-M012DC2	1SVR405611R4000	10	0.033 (0.073)				
24 V DC			CR-M024DC2	1SVR405611R1000						
48 V DC			CR-M048DC2	1SVR405611R6000						
60 V DC			CR-M060DC2	1SVR405611R4200						
110 V DC			CR-M110DC2	1SVR405611R8000						
125 V DC			CR-M125DC2	1SVR405611R8200						
220 V DC			CR-M220DC2	1SVR405611R9000						
24 V AC			CR-M024AC2	1SVR405611R0000						
48 V AC			CR-M048AC2	1SVR405611R5000						
110 V AC			CR-M110AC2	1SVR405611R7000						
120 V AC			CR-M120AC2	1SVR405611R2000						
230 V AC			CR-M230AC2	1SVR405611R3000						
12 V DC			3 c/o (SPDT)	250 V AC, 10 A			CR-M012DC3	1SVR405612R4000	10	0.033 (0.073)
24 V DC							CR-M024DC3	1SVR405612R1000		
48 V DC	CR-M048DC3	1SVR405612R6000								
60 V DC	CR-M060DC3	1SVR405612R4200								
110 V DC	CR-M110DC3	1SVR405612R8000								
125 V DC	CR-M125DC3	1SVR405612R8200								
220 V DC	CR-M220DC3	1SVR405612R9000								
24 V AC	CR-M024AC3	1SVR405612R0000								
48 V AC	CR-M048AC3	1SVR405612R5000								
60 V AC	CR-M060AC3	1SVR405612R5200								
110 V AC	CR-M110AC3	1SVR405612R7000								
120 V AC	CR-M120AC3	1SVR405612R2000								
230 V AC	CR-M230AC3	1SVR405612R3000								
12 V DC	4 c/o (SPDT)	250 V AC, 6 A			CR-M012DC4	1SVR405613R4000	10	0.033 (0.073)		
24 V DC			CR-M024DC4	1SVR405613R1000						
48 V DC			CR-M048DC4	1SVR405613R6000						
60 V DC			CR-M060DC4	1SVR405613R4200						
110 V DC			CR-M110DC4	1SVR405613R8000						
125 V DC			CR-M125DC4	1SVR405613R8200						
220 V DC			CR-M220DC4	1SVR405613R9000						
24 V AC			CR-M024AC4	1SVR405613R0000						
48 V AC			CR-M048AC4	1SVR405613R5000						
110 V AC			CR-M110AC4	1SVR405613R7000						
120 V AC			CR-M120AC4	1SVR405613R2000						
230 V AC			CR-M230AC4	1SVR405613R3000						

* Note: During the operation of the relay, the temperature of the test button will increase. In order to manually operate the test button, the supply voltage should first be disconnected. The test button is only safe to operate once it has cooled down or by using protective gloves and insulated tools. During operation, the test button should be pressed smoothly and quickly. When the test button is depressed, the n/o contacts will close and remain closed. Once the button is released, the n/o contacts change status and open. A 90 degree rotation of the test button closes and holds the n/o contacts in a closed position. Reverse rotation of the test button will once again change the status of the n/o contacts to their default open position.

Pluggable interface relays and optocouplers

Ordering details – CR-M range



CR-M

Ordering details - CR-M range with LED

Rated control supply voltage	Outputs	Contact ratings	Type	Order code	Pkg qty	Weight (1 pc.) kg (lb)
12 V DC	2 c/o (SPDT)	250 V AC, 12 A	CR-M012DC2L	1SVR405611R4100	10	0.033 (0.073)
24 V DC			CR-M024DC2L	1SVR405611R1100		
48 V DC			CR-M048DC2L	1SVR405611R6100		
60 V DC			CR-M060DC2L	1SVR405611R4300		
110 V DC			CR-M110DC2L	1SVR405611R8100		
125 V DC			CR-M125DC2L	1SVR405611R8300		
220 V DC			CR-M220DC2L	1SVR405611R9100		
12 V AC			CR-M012AC2L	1SVR405611R0300		
24 V AC			CR-M024AC2L	1SVR405611R0100		
48 V AC			CR-M048AC2L	1SVR405611R5100		
110 V AC			CR-M110AC2L	1SVR405611R7100		
120 V AC			CR-M120AC2L	1SVR405611R2100		
230 V AC			CR-M230AC2L	1SVR405611R3100		
12 V DC			3 c/o (SPDT)	250 V AC, 10 A		
24 V DC	CR-M024DC3L	1SVR405612R1100				
48 V DC	CR-M048DC3L	1SVR405612R6100				
60 V DC	CR-M060DC3L	1SVR405612R4300				
110 V DC	CR-M110DC3L	1SVR405612R8100				
125 V DC	CR-M125DC3L	1SVR405612R8300				
220 V DC	CR-M220DC3L	1SVR405612R9100				
12 V AC	CR-M012AC3L	1SVR405612R0300				
24 V AC	CR-M024AC3L	1SVR405612R0100				
48 V AC	CR-M048AC3L	1SVR405612R5100				
110 V AC	CR-M110AC3L	1SVR405612R7100				
120 V AC	CR-M120AC3L	1SVR405612R2100				
230 V AC	CR-M230AC3L	1SVR405612R3100				
12 V DC	4 c/o (SPDT)	250 V AC, 6 A			CR-M012DC4L	1SVR405613R4100
24 V DC			CR-M024DC4L	1SVR405613R1100		
48 V DC			CR-M048DC4L	1SVR405613R6100		
60 V DC			CR-M060DC4L	1SVR405613R4300		
110 V DC			CR-M110DC4L	1SVR405613R8100		
125 V DC			CR-M125DC4L	1SVR405613R8300		
220 V DC			CR-M220DC4L	1SVR405613R9100		
12 V AC			CR-M012AC4L	1SVR405613R0300		
24 V AC			CR-M024AC4L	1SVR405613R0100		
48 V AC			CR-M048AC4L	1SVR405613R5100		
110 V AC			CR-M110AC4L	1SVR405613R7100		
120 V AC			CR-M120AC4L	1SVR405613R2100		
230 V AC			CR-M230AC4L	1SVR405613R3100		

Pluggable interface relays and optocouplers

Ordering details – CR-M range



CR-M

Ordering details - CR-M range with LED and free-wheeling diode

Rated control supply voltage	Outputs	Contact ratings	Type	Order code	Pkg qty	Weight (1 pc.) kg (lb)
12 V DC	2 c/o (SPDT)	250 V AC, 6 A	CR-M012DC2LD	1SVR405611R4400	10	0.033 (0.073)
24 V DC			CR-M024DC2LD	1SVR405611R1400	10	0.033 (0.073)
48 V DC			CR-M048DC2LD	1SVR405611R6400	10	0.033 (0.073)
110 V DC			CR-M110DC2LD	1SVR405611R8400	10	0.033 (0.073)
125 V DC			CR-M125DC2LD	1SVR405611R8500	10	0.033 (0.073)
220 V DC			CR-M220DC2LD	1SVR405611R9400	10	0.033 (0.073)
12 V DC	3 c/o (SPDT)	250 V AC, 10 A	CR-M012DC3LD	1SVR405612R4400	10	0.033 (0.073)
24 V DC			CR-M024DC3LD	1SVR405612R1400	10	0.033 (0.073)
48 V DC			CR-M048DC3LD	1SVR405612R6400	10	0.033 (0.073)
110 V DC			CR-M110DC3LD	1SVR405612R8400	10	0.033 (0.073)
125 V DC			CR-M125DC3LD	1SVR405612R8500	10	0.033 (0.073)
220 V DC			CR-M220DC3LD	1SVR405612R9400	10	0.033 (0.073)
12 VDC	4 c/o (SPDT)	250 V AC, 6 A	CR-M012DC4LD	1SVR405613R4400	10	0.033 (0.073)
24 V DC			CR-M024DC4LD	1SVR405614R1100	10	0.033 (0.073)
48 V DC			CR-M048DC4LD	1SVR405613R6400	10	0.033 (0.073)
110 V DC			CR-M110DC4LD	1SVR405613R8400	10	0.033 (0.073)
125 V DC			CR-M125DC4LD	1SVR405613R8500	10	0.033 (0.073)
220 V DC			CR-M220DC4LD	1SVR405613R9400	10	0.033 (0.073)

Ordering details - CR-M range with gold contacts

Rated control supply voltage	Outputs	Contact ratings	Type	Order code	Pkg qty	Weight (1 pc.) kg (lb)
24 V DC	4 c/o (SPDT)	250 V AC, 6 A	CR-M024DC4G	1SVR405618R1000	10	0.033 (0.073)
24 V AC			CR-M024AC4G	1SVR405618R0000		
110 V AC			CR-M110AC4G	1SVR405618R7000		
230 V AC			CR-M230AC4G	1SVR405618R3000		

Pluggable interface relays and optocouplers

Ordering details – CR-M range



CR-M

Ordering details – CR-M range with gold contacts and LED

Rated control supply voltage	Outputs	Contact ratings	Type	Order code	Pkg qty	Weight (1 pc.) kg (lb)
12 V DC	4 c/o (SPDT)	250 V AC, 6 A	CR-M012DC4LG	1SVR405618R4100	10	0.033 (0.073)
24 V DC			CR-M024DC4LG	1SVR405618R1100		
48 V DC			CR-M048DC4LG	1SVR405618R6100		
60 V DC			CR-M060DC4LG	1SVR405618R4300		
110 V DC			CR-M110DC4LG	1SVR405618R8100		
125 V DC			CR-M125DC4LG	1SVR405618R8300		
220 V DC			CR-M220DC4LG	1SVR405618R9100		
24 V AC			CR-M024AC4LG	1SVR405618R0100		
48 V AC	CR-M048AC4LG	1SVR405618R5100				
110 V AC	CR-M110AC4LG	1SVR405618R7100				
120 V AC	CR-M120AC4LG	1SVR405618R2100				
230 V AC	CR-M230AC4LG	1SVR405618R3100				

Ordering details – CR-M range with gold contacts, LED and free-wheeling diode

Rated control supply voltage	Outputs	Contact ratings	Type	Order code	Pkg qty	Weight (1 pc.) kg (lb)
12 V DC	4 c/o (SPDT)	250 V AC, 6 A	CR-M012DC4LDG	1SVR405618R4400	10	0.033 (0.073)
24 V DC			CR-M024DC4LDG	1SVR405618R1400		

Pluggable interface relays and optocouplers

Ordering details – CR-M range



CR-M complete version

Ordering details – CR-M range complete version

Rated control supply voltage	Out-puts	Description	Socket type	Con-nection terminal	Type	Order code	Pkg	Weight
							qty	(1 pc.) kg (lb)
12 V DC	4 c/o gold-plated	LED red, holder	standard	screw	CR-M012DC4LDGSS	1SVR405618R4410	10	0.0109 (0.024)
24 V DC	4 c/o	Reverse polarity protection and free-wheeling diode, LED green, holder	standard	screw	CR-M024DC4SS42V	1SVR405613R1010	10	0.0109 (0.024)
		Reverse polarity protection and free-wheeling diode, LED green, holder	logical	screw	CR-M024DC4LS42V	1SVR405613R1011	10	0.0109 (0.024)
		Reverse polarity protection and free-wheeling diode, LED red, holder	logical	spring	CR-M024DC4LC42	1SVR405613R1012	10	0.0109 (0.024)
24 V DC	4 c/o gold-plated	Reverse polarity protection and free-wheeling diode, LED green, holder	standard	screw	CR-M024DC4GSS42V	1SVR405618R1011	10	0.0109 (0.024)
		Varistor, LED green, holder	logical	spring	CR-M024DC4GLC62CV	1SVR405618R1010	10	0.0109 (0.024)
		LED, free-wheeling diode, holder	logical	spring	CR-M024DC4LGLC22	1SVR405618R1110	10	0.0109 (0.024)
		LED red, free-wheeling diode, holder	standard	screw	CR-M024DC4LDGSS	1SVR405618R1410	10	0.0109 (0.024)
24 V AC	4 c/o	Varistor and LED green, holder	logical	screw	CR-M024AC4LS62CV	1SVR405613R0010	10	0.0109 (0.024)

Pluggable interface relays and optocouplers

Ordering details – CR-M range



CR-M complete version

2CDCR91002F0019

Ordering details – CR-M range complete version

Rated control supply voltage	Out-puts	Description	Socket type	Connection terminal	Type	Order code	Pkg	Weight
							qty	(1 pc.) kg (lb)
230 V AC	4 c/o	Varistor, LED green, holder	standard	screw	CR-M230AC4SS92CV	1SVR405613R3110	10	0.0109 (0.024)
		Varistor, LED green, holder	logical	screw	CR-M230AC4LS92CV	1SVR405613R3011	10	0.0109 (0.024)
		Diode and LED red, holder	logical	spring	CR-M230AC4LC92	1SVR405613R3012	10	0.0109 (0.024)
230 V AC	4 c/o gold-plated	Reverse polarity protection and free-wheeling diode, LED green, holder	standard	screw	CR-M230AC4GSS92CV	1SVR405618R3112	10	0.0109 (0.024)
		LED red, holder	logical	screw	CR-M230AC4LGLC	1SVR405618R3110	10	0.0109 (0.024)
		LED red, holder	standard	screw	CR-M230AC4LGSS	1SVR405618R3111	10	0.0109 (0.024)

Pluggable interface relays and optocouplers

Ordering details – CR-M range



CR-M2LS

2CDC291.04.F0004



CR-M4SS

2CDC291.009.F0011

Standard and logical sockets for CR-M interface relays are suitable for snap-on mounting onto a DIN rail. Optional function modules for the CR-M range are plugged into both standard and logical sockets.

Ordering details - Sockets*

Version	Connection terminal	Type	Order code	Pkg qty	Weight (1 pc.) kg (lb)
Logical socket for 2 c/o	screw	CR-M2LS	1SVR405651R1100	10	0.055 (0.121)
Logical socket for 3 c/o		CR-M3LS	1SVR405651R2100		0.062 (0.137)
Logical socket for 2/4 c/o		CR-M4LS	1SVR405651R3100		0.066 (0.146)
High Performance Logical Socket for 2 c/o		CR-M2LSH	1SVR405651R4100		0.064 (0.141)
High Performance Logical Socket for 3 c/o		CR-M3LSH	1SVR405651R5100		0.071 (0.157)
Logical socket for 2/4 c/o	spring	CR-M4LC	1SVR405651R3200	10	0.066 (0.146)
Standard socket for 2 c/o	screw	CR-M2SS	1SVR405651R1000	10	0.066 (0.146)
Standard socket for 3 c/o		CR-M3SS	1SVR405651R2000		0.068 (0.150)
Standard socket for 2/4 c/o		CR-M4SS	1SVR405651R3000		0.070 (0.154)
Standard socket for 2 c/o	fork type	CR-M2SF	1SVR405651R1300	10	0.040 (0.088)
Standard socket for 2/4 c/o		CR-M4SF	1SVR405651R3300		0.048 (0.106)

*All CR-M socket packages include a set of markers.

Standard sockets

Position of connection terminals: coil connection (A1-A2) on lower side of the socket, contact connections (n/o and n/c contacts) on the lower and upper side of the socket.

Logical sockets

Position of connection terminals: coil connection (A1-A2) on lower side of the socket, all contact connections (common contacts, n/o and n/c contacts) on upper side of the socket.

Ordering details - Accessories



CR-MJ

2CDC291.005.F0007

Version	Type	Order code	Pkg qty	Weight (1 pc.) kg (lb)
Plastic holder for socket	CR-MH	1SVR405659R1000	10	0.003 (0.007)
Metal holder for socket	CR-MH1	1SVR405659R1100	10	0.0005 (0.001)
Jumper bar for sockets with screw connection	CR-MJ	1SVR405658R6000	10	0.029 (0.064)
Marker for CR-M standard sockets	CR-MM	1SVR405658R1000	10	0.0005 (0.001)
Plug for test button replacement	CR-MP	1SVR405658R2000	100	0.001 (0.002)

Pluggable interface relays and optocouplers

Ordering details – CR-P/M function modules



CR-P/M...

Ordering details - Diode - Reverse polarity protection / free-wheeling diode

Rated control supply voltage U_s	Version	Type	Order code	Pkg qty	Weight (1 pc.) kg (lb)
6-220 V DC	A1+, A2-	CR-P/M 22	1SVR405651R0000	10	0.003 (0.007)

Ordering details - Diode and LED - Reverse polarity protection / free-wheeling diode and LED to indicate energized coil

Rated control supply voltage U_s	Version	Type	Order code	Pkg qty	Weight (1 pc.) kg (lb)
6-24 V DC	red, A1+, A2-	CR-P/M 42	1SVR405652R0000	10	0.003 (0.007)
6-24 V DC	green, A1+, A2-	CR-P/M 42 V	1SVR405652R1000		
24-60 V DC	red, A1+, A2-	CR-P/M 42 B	1SVR405652R4000		
24-60 V DC	green, A1+, A2-	CR-P/M 42 BV	1SVR405652R4100		
110 V DC	red, A1+, A2-	CR-P/M 42 C	1SVR405652R9000		
110 V DC	green, A1+, A2-	CR-P/M 42 CV	1SVR405652R9100		

Ordering details - RC element - Spark quenching

Rated control supply voltage U_s	Version	Type	Order code	Pkg qty	Weight (1 pc.) kg (lb)
6-24 V AC/DC		CR-P/M 52B	1SVR405653R0000	10	0.003 (0.007)
24-60 V AC/DC		CR-P/M 52D	1SVR405653R4000		
110-230 V AC/DC		CR-P/M 52C	1SVR405653R1000		

Ordering details - Diode and LED - LED to indicate energized coil

Rated control supply voltage U_s	Version	Type	Order code	Pkg qty	Weight (1 pc.) kg (lb)
6-24 V AC/DC	red, for DC: A1+, A2-	CR-P/M 62	1SVR405654R0000	10	0.003 (0.007)
6-24 V AC/DC	green, for DC: A1+, A2-	CR-P/M 62 V	1SVR405654R1000		
24-60 V AC/DC	red, for DC: A1+, A2-	CR-P/M 62 E	1SVR405654R4000		
24-60 V AC/DC	green, for DC: A1+, A2-	CR-P/M 62 EV	1SVR405654R4100		
110-230 V AC/DC	red, for DC: A1+, A2-	CR-P/M 92	1SVR405654R0100		
110-230 V AC/DC	green, for DC: A1+, A2-	CR-P/M 92 V	1SVR405654R1100		

Pluggable interface relays and optocouplers

Ordering details – CR-P/M function modules



CR-P/M ...

Ordering details - Varistor and LED - Overvoltage protection and LED to indicate energized coil

Rated control supply voltage U_c	Version	Type	Order code	Pkg qty	Weight (1 pc.) kg (lb)
6-24 V AC/DC	red, for DC: A1+, A2-	CR-P/M 62 C	1SVR405655R0000	10	0.003 (0.007)
6-24 V AC/DC	green, for DC: A1+, A2-	CR-P/M 62 CV	1SVR405655R1000		
24-60 V AC/DC	red, for DC: A1+, A2-	CR-P/M 62 D	1SVR405655R4000		
24-60 V AC/DC	green, for DC: A1+, A2-	CR-P/M 62 DV	1SVR405655R4100		
110-230 V AC/DC	red, for DC: A1+, A2-	CR-P/M 92 C	1SVR405655R0100		
110-230 V AC/DC	green, for DC: A1+, A2-	CR-P/M 92 CV	1SVR405655R1100		

Ordering details - Varistor - Overvoltage protection

Rated control supply voltage U_c	Version	Type	Order code	Pkg qty	Weight (1 pc.) kg (lb)
24 V AC		CR-P/M 72	1SVR405656R0000	10	0.002 (0.004)
115 V AC		CR-P/M 72 A	1SVR405656R1000		
230 V AC		CR-P/M 82	1SVR405656R2000		

Pluggable interface relays and optocouplers

Ordering details – CR-U range



CR-U

The CR-U range offers up to 3 change over contacts in single relay. The integrated LED and test button* allow for easy testing and commissioning. This robust range of relays are available at a wide range of different coil voltages and are accompanied by a wide variety of function modules.

Ordering details - CR-U range without LED

Rated control supply voltage	Outputs	Contact ratings	Type	Order code	Pkg qty	Weight (1 pc.) kg (lb)				
12 V DC	2 c/o (SPDT)	250 V AC, 10 A	CR-U012DC2	1SVR405621R4000	10	0.083 (0.183)				
24 V DC			CR-U024DC2	1SVR405621R1000						
48 V DC			CR-U048DC2	1SVR405621R6000						
110 V DC			CR-U110DC2	1SVR405621R8000						
220 V DC			CR-U220DC2	1SVR405621R9000						
24 V AC			CR-U024AC2	1SVR405621R0000						
48 V AC			CR-U048AC2	1SVR405621R5000						
110 V AC			CR-U110AC2	1SVR405621R7000						
120 V AC			CR-U120AC2	1SVR405621R2000						
230 V AC			CR-U230AC2	1SVR405621R3000						
12 V DC			3 c/o (SPDT)	250 V AC, 10 A			CR-U012DC3	1SVR405622R4000	10	0.083 (0.183)
24 V DC							CR-U024DC3	1SVR405622R1000		
48 V DC							CR-U048DC3	1SVR405622R6000		
110 V DC							CR-U110DC3	1SVR405622R8000		
125 V DC	CR-U125DC3	1SVR405622R8200								
220 V DC	CR-U220DC3	1SVR405622R9000								
24 V AC	CR-U024AC3	1SVR405622R0000								
48 V AC	CR-U048AC3	1SVR405622R5000								
60 V AC	CR-U060AC3	1SVR405622R5200								
110 V AC	CR-U110AC3	1SVR405622R7000								
120 V AC	CR-U120AC3	1SVR405622R2000								
230 V AC	CR-U230AC3	1SVR405622R3000								

* Note: During the operation of the relay, the temperature of the test button will increase. In order to manually operate the test button, the supply voltage should first be disconnected. The test button is only safe to operate once it has cooled down or by using protective gloves and insulated tools. During operation, the test button should be pressed smoothly and quickly. When the test button is depressed, the n/o contacts will close and remain closed. Once the button is released, the n/o contacts change status and open. A 90 degree rotation of the test button closes and holds the n/o contacts in a closed position. Reverse rotation of the test button will once again change the status of the n/o contacts to their default open position.

Ordering details - CR-U range with LED

Rated control supply voltage	Outputs	Contact ratings	Type	Order code	Pkg qty	Weight (1 pc.) kg (lb)
12 V DC	2 c/o (SPDT)	250 V AC, 10 A	CR-U012DC2L	1SVR405621R4100	10	0.083 (0.183)
24 V DC			CR-U024DC2L	1SVR405621R1100		
48 V DC			CR-U048DC2L	1SVR405621R6100		
110 V DC			CR-U110DC2L	1SVR405621R8100		
220 V DC			CR-U220DC2L	1SVR405621R9100		
12 V AC			CR-U012AC2L	1SVR405621R0300		
24 V AC			CR-U024AC2L	1SVR405621R0100		
48 V AC			CR-U048AC2L	1SVR405621R5100		
110 V AC			CR-U110AC2L	1SVR405621R7100		
120 V AC			CR-U120AC2L	1SVR405621R2100		
230 V AC			CR-U230AC2L	1SVR405621R3100		

Pluggable interface relays and optocouplers

Ordering details – CR-U range

Ordering details - CR-U range with LED

Rated control supply voltage	Outputs	Contact ratings	Type	Order code	Pkg qty	Weight (1 pc.) kg (lb)
12 V DC	3 c/o (SPDT)	250 V AC, 10 A	CR-U012DC3L	1SVR405622R4100	10	0.083 (0.183)
24 V DC			CR-U024DC3L	1SVR405622R1100		
48 V DC			CR-U048DC3L	1SVR405622R6100		
110 V DC			CR-U110DC3L	1SVR405622R8100		
220 V DC			CR-U220DC3L	1SVR405622R9100		
12 V AC			CR-U012AC3L	1SVR405622R0300		
24 V AC			CR-U024AC3L	1SVR405622R0100		
48 V AC			CR-U048AC3L	1SVR405622R5100		
110 V AC			CR-U110AC3L	1SVR405622R7100		
120 V AC			CR-U120AC3L	1SVR405622R2100		
230 V AC			CR-U230AC3L	1SVR405622R3100		

Ordering details - CR-U range with LED and free-wheeling diode

Rated control supply voltage	Outputs	Contact ratings	Type	Order code	Pkg qty	Weight (1 pc.) kg (lb)
12 V DC	2 c/o (SPDT)	250 V AC, 10 A	CR-U012DC2LD	1SVR405621R4400	10	0.033 (0.073)
24 V DC			CR-U024DC2LD	1SVR405621R1400	10	0.033 (0.073)
48 V DC			CR-U048DC2LD	1SVR405621R6400	10	0.033 (0.073)
110 V DC			CR-U110DC2LD	1SVR405621R8400	10	0.033 (0.073)
12 V DC	3 c/o (SPDT)	250 V AC, 10 A	CR-U012DC3LD	1SVR405622R4400	10	0.033 (0.073)
24 V DC			CR-U024DC3LD	1SVR405623R1100	10	0.033 (0.073)
48 V DC			CR-U048DC3LD	1SVR405622R6400	10	0.033 (0.073)
110 V DC			CR-U110DC3LD	1SVR405622R8400	10	0.033 (0.073)



CR-U

2CDC 291 047 F0004

The sockets for CR-U interface relays have screw connection terminals and are suitable for snap-on mounting onto a DIN rail. Optional function modules for the CR-U range may only be plugged into compatible standard sockets.

Ordering details - Sockets and Accessories

Version	Type	Order code	Pkg qty	Weight (1 pc.) kg
Socket for 2 c/o and function module	CR-U2S	1SVR405670R0000	10	0.065
Socket for 3 c/o and function module	CR-U3S	1SVR405660R0000		0.065
Small socket for 2 c/o	CR-U2SM	1SVR405670R1100		0.054
Small socket for 3 c/o	CR-U3SM	1SVR405660R1100		0.058
Metal holder for socket	CR-UH	1SVR405669R0000		0.001



CR-U2S

2CDC 291 007 S0011

CR-U sockets

Position of connection terminals: coil connection (A1-A2) on lower side of socket, contact connections (n/o and n/c contacts) on the lower and upper side of socket.

Pluggable interface relays and optocouplers

Ordering details – CR-U function modules



CR-U...

2CDC291-004-S0011

CR-U function modules are compatible with the CR-U2S and CR-U3S sockets only.

Diode - Reverse polarity protection / free-wheeling diode

Rated control supply voltage	Version	Type	Order code	Pkg qty	Weight (1 pc.) kg (lb)
6-220 V DC	A1+, A2-	CR-U 21	1SVR405661R0000	10	0.007 (0.015)

Diode and LED - Reverse polarity protection / free-wheeling diode and LED to indicate energized coil

Rated control supply voltage	Version	Type	Order code	Pkg qty	Weight (1 pc.) kg (lb)
6-24 V DC	red, A1+, A2-	CR-U 41	1SVR405662R0000	10	0.007 (0.015)
6-24 V DC	green, A1+, A2-	CR-U 41V	1SVR405662R1000		
24-60 V DC	red, A1+, A2-	CR-U 41B	1SVR405662R4000		
24-60 V DC	green, A1+, A2-	CR-U 41BV	1SVR405662R4100		
110 V DC	red, A1+, A2-	CR-U 41C	1SVR405662R9000		
110 V DC	green, A1+, A2-	CR-U 41CV	1SVR405662R9100		

RC element - Spark quenching

Rated control supply voltage	Version	Type	Order code	Pkg qty	Weight (1 pc.) kg (lb)
6-24 V AC/DC		CR-U 51B	1SVR405663R0000	10	0.007 (0.015)
24-60 V AC/DC		CR-U 51D	1SVR405663R4000		
110 -230 V AC/DC		CR-U 51C	1SVR405663R1000		

Diode and LED - LED to indicate energized coil

Rated control supply voltage	Version	Type	Order code	Pkg qty	Weight (1 pc.) kg (lb)
6-24 V AC/DC	red, for DC A1+, A2-	CR-U 61	1SVR405664R0000	10	0.007 (0.015)
6-24 V AC/DC	green, for DC A1+, A2-	CR-U 61V	1SVR405664R1000		
24-60 V AC/DC	red, for DC A1+, A2-	CR-U 61E	1SVR405664R4000		
24-60 V AC/DC	green, for DC A1+, A2-	CR-U 61EV	1SVR405664R4100		
110-230 V AC/DC	red, for DC A1+, A2-	CR-U 91	1SVR405664R0100		
110-230 V AC/DC	green, for DC: A1+, A2-	CR-U 91V	1SVR405664R1100		

Pluggable interface relays and optocouplers

Ordering details – CR-U function modules



CR-U...

2CDC291 004 50011

Varistor and LED - Overvoltage protection and LED to indicate energized coil

Rated control supply voltage	Version	Type	Order code	Pkg qty	Weight (1 pc.) kg (lb)
6-24 V AC/DC	red, for DC A1+, A2-	CR-U 61C	1SVR405665R0000	10	0.007 (0.015)
6-24 V AC/DC	green, for DC A1+, A2-	CR-U 61CV	1SVR405665R1000		
24-60 V AC/DC	red, for DC A1+, A2-	CR-U 61D	1SVR405665R4000		
24-60 V AC/DC	green, for DC A1+, A2-	CR-U 61DV	1SVR405665R4100		
110-230 V AC/DC	red, for DC A1+, A2-	CR-U 91C	1SVR405665R0100		
110-230 V AC/DC	green, for DC A1+, A2-	CR-U 91CV	1SVR405665R1100		



CR-U T

2CDC291 032 F0005

Varistor - Overvoltage protection

Rated control supply voltage	Version	Type	Order code	Pkg qty	Weight (1 pc.) kg (lb)
24 V AC		CR-U 71	1SVR405666R0000	10	0.007 (0.015)
115 V AC		CR-U 71A	1SVR405666R1000		
230 V AC		CR-U 81	1SVR405666R2000		

Multi-function time module*

Rated control supply voltage	Version	Type	Order code	Pkg qty	Weight (1 pc.) kg (lb)
24-240 V AC/DC	green LED	CR-U T	1SVR405667R0000	10	0.014 (0.031)

* For more details, refer to the [CR-U T datasheet](#).

Pluggable interface relays and optocouplers

Technical data - CR-S interface relays

Input circuit							
	Rated control supply voltage U_s	Make voltage (at 23 °C)	Maximum voltage (at 55 °C)	Break voltage	Rated power	Coil resistance (at 23 °C)	Tolerance of coil resistance
CR-S005VDC1R(G)	5 V DC	3.75 V DC	7.5 V DC	0.25 V DC	170 mW	147 Ω	$\pm 10\%$
CR-S012VDC1R(G)	12 V DC	9 V DC	18 V DC	0.6 V DC	170 mW	848 Ω	$\pm 10\%$
CR-S024VDC1R(G)	24 V DC	18 V DC	36 V DC	1.2 V DC	170 mW	3390 Ω	$\pm 15\%$
CR-S048VDC1R(G)	48 V DC	36 V DC	72 V DC	2.4 V DC	210 mW	10600 Ω	$\pm 15\%$
CR-S060VDC1R(G)	60 V DC	45 V DC	90 V DC	3 V DC	210 mW	16600 Ω	$\pm 15\%$

Output circuits			
Output circuit(s)	11-12/14		
Kind of output	1 c/o (SPDT)		
Contact material	AgSnO ₂ or AgSnO ₂ /Au		
Rated operational voltage U_e (IEC/EN 60947-1)	250 V AC		
Minimum switching voltage	5 V at 100 mA (AgSnO ₂) / 5 V at 12 mA (AgSnO ₂ /Au)		
Maximum switching voltage	400 V AC / 250 V DC		
Minimum switching current	10 mA at 10 V (AgSnO ₂) / 3 mA at 20 V (AgSnO ₂ /Au)		
Rated free air thermal current I_{th}	5 A		
Rated operational current (IEC/EN 60947-5-1)	AC12 (resistive) 230 V	6 A	
	AC15 (inductive) 230 V	1.5 A	
	AC15 (inductive) 120 V	3 A	
	DC12 (resistive) 24 V	6 A	
	DC13 (inductive) 24 V	1 A	
	DC13 (inductive) 120 V	0.22 A	
	DC13 (inductive) 250 V	0.11 A	
AC rating (UL 508; NEMA ICS-5)	utilization category (pilot duty) (contact rating code designation)	B300	
DC rating (UL 508; NEMA ICS-5)	utilization category (pilot duty) (contact rating code designation)	R300	
Maximum making (inrush) current	15 A, 240 V AC		
Minimum switching power	100 mA/12 V (AgSnO ₂) / 50 mW (AgSnO ₂ /Au)		
Maximum switching (breaking) power	AC1 (resistive)	1500 VA, 250 V AC	
Contact resistance	$\leq 100\text{ m}\Omega$ (at 1 A 6 V DC) / gold-plated: $\leq 30\text{ m}\Omega$ (at 1 A 6 V DC)		
Maximum operating frequency	rated load AC1	360 switching cycles/h	
	without load	18000 switching cycles/h	
Mechanical lifetime	1 x 10 ⁷ switching cycles		
Electrical lifetime	AC1 (resistive)	(n/c) 3 x 10 ⁴ switching cycles (at +85 °C) (n/o) 1 x 10 ⁴ switching cycles (at +85 °C)	
Response time	8 ms		
Release time	4 ms		

Isolation data	
Rated insulation voltage	250 V AC
Rated impulse withstand voltage U_{imp}	between coil and contacts
	between open contacts
Clearance	between coil and contacts
Creepage distance	between coil and contacts
Overvoltage category	III
Pollution degree	2

General data	
Dimensions	see 'Dimensional drawings'
Mounting	on socket
Mounting position	any
Degree of protection	RT II and RT III

Pluggable interface relays and optocouplers

Technical data - CR-S interface relays and CR-S optocouplers

Electrical connection		
Connection	by socket	
Environmental data		
Ambient temperature range	operation	-40...+85 °C
	storage	-40...+85 °C
Vibration resistance (10-150 Hz)	n/o contact	10 Hz to 55 Hz 1 mm DA
	n/c contact	10 Hz to 55 Hz 1 mm DA
Shock resistance	n/o contact	function 49 m/s ² / destructive 980 m/s ²
	n/c contact	function 49 m/s ² / destructive 980 m/s ²
Standards/directives		
Standards	IEC/EN 61810-1	
RoHS Directive	2011/65/EU	

Technical data - CR-S optocouplers

Input circuit	CR-S024VDC1TRA	CR-S024VDC1MOS	CR-S024VDC1TRI
Input resistance	3400 Ohm		
Rated control voltage	24 V DC*		
Pull-in voltage	15 V DC		
Maximum control voltage	30 V DC		
Nominal input current	7 mA		
Input power	168 mW		
Typical switching-on time	< 40 ms	< 60 ms	< 1/2 cycle
Typical switch-off time	< 600 ms	< 600 ms	< 1/2 cycle
Output circuits			
Output circuit(s)	11 (13+) - 14	11 (13+) - 14	11 (13+) - 14
Kind of output	Transistor	MOS-FET	Triac
Rated operational voltage	48 V DC	24 V DC	240 V AC
Maximum switching voltage	48 V DC	24 V DC	275 V AC
Minimum switching current	50 mA	50 mA	22 mA
Maximum switching current continuously	100 mA	2 A	2 A
Leakage current at maximum switching voltage	<1 mA	<1 mA	< 1.5 mA
Voltage drop at rated current	< 120 mV DC	< 120 mV DC	< 1.6 V AC
Isolation data			
Rated insulation voltage	input/output	2.5 kV	
Insulation class		2	
Clearance	input/output	14 mm	
Creepage distance	input/output	14 mm	
Overtoltage category		III	
Pollution degree		2	
General data			
Dimensions	see 'Dimensional drawings'		
Weight	3.5 g (0.007 lb)		
Mounting	on socket		
Environmental data			
Ambient temperature	operation	-30...+80 °C	
	storage	-40...+100 °C	
Standards / Directives			
Standards	IEC/EN 62314		
EMC Directive	2014/30/EN		
RoHS Directive	2011/65/EN		

* The output circuit should not exceed 30 m.

Pluggable interface relays and optocouplers

Technical data - CR-S sockets

Input circuit	CR-S 6-24 V	CR-S 12-24 V	CR-S 48-60 V	CR-S 110-125 V	CR-S 220-240 V
Rated control supply voltage U_s	6-24 V DC	12-24 V AC/DC*	48-60 V AC/DC	110-125 V AC/DC	220-240 V AC/DC
Rated control supply voltage tolerance	(0.8-1.2) U_s	(0.8-1.2) U_s			
Typical current	11-29 mA	11-16 mA	3.6-4.5 mA	3.6 mA	3.6 mA
Response time	8 ms				
Release time	4 ms				
Status device	green LED				
Protective circuit	yes				
Output circuits					
Output circuit(s)	11-12/14				
Number of poles	1				
Rated voltage	250 V AC				
Rated current	6 A				
General data for CR-S with screw connection terminal					
Dimensions	see 'Dimensional drawings'				
Degree of protection (EN 60529)	IP20 (terminals)				
Temperature range	operation	-40...+70 °C			-40...+55 °C
	storage	-40...+85 °C			
Connection type	Screw				
Maximum number of wires per connection terminal	2				
Connecting capacity	rigid	2 x 0.5 - 1.5 mm ² (2 x 20 - 16 AWG)			
	fine-strand				
	with wire end ferule	2 x 0.5 - 1 mm ² (2 x 20 - 18 AWG)			
Tightening torque	0.5 Nm (4.426 lb.in)				
Stripping length	7 mm (0.28 in)				
Minimum clamping force for fine-strand wire	with 0.2 mm ²	10 N			
	with 1.5 mm ²	40 N			
Mounting (IEC/EN 60715)	DIN rail				
Material	socket	PA6 + GF - UL94 V0			
	contacts	CuZn36			
	contact surface	3 μ Ni/Sn			
	terminals	CuZn40, 3 μ Ni			
	combi screw M3	Fe			
General data for CR-S with spring connection terminal					
Dimensions without holder (L x W x H)	see 'Dimensional drawings'				
Degree of protection (EN 60529)	Degree of protection (EN 60529) IP20 (terminals)				
Temperature range	operation	-40...+70 °C			-40...+55 °C
	storage	-40...+85 °C			
Connection type	Spring				
Maximum number of wires per connection terminal	1				
Connecting capacity	0.75 - 2.5 mm ² (20 - 14 AWG) rigid, fine-strand and with wire end ferrule				
Stripping length	7 mm (0.28 in)				
Mounting (IEC/EN 60715)	DIN rail				
Material	socket	PA6 + GF - UL94 V0			
	contacts	CuZn36			
	contact surface	3 μ Ni/Sn			
	spring terminals	SUS301			
Isolation data					
Isolation between coil and contacts	5000 V AC				
Resistance to shock coil to contact	1000 MΩ				
Clearance and creepage distance	IEC/EN 61984				
Standards / Directives					
Standard	IEC/EN 61984				
Low Voltage Directive	2014/35/EU				
RoHS Directive	2011/65/EU				

* In combination with optocouplers, only DC supply is allowed

Pluggable interface relays and optocouplers

Technical data - CR-S jumper bars

Rated operational voltage / current		CR-SJB20-BLUE	CR-SJB20-RED	CR-SJB20-BLACK
Rated operational voltage		250 V AC		
Rated operational current		36 A		
Electrical connection				
Jumper bar cross section		123.2 mm (4.850 in)		
Step distance		6.3 mm (0.248 in)		
Rail length		with isolation 16.7 mm (0.657 in)		
		without isolation 6.7 mm (0.264 in)		
Stripping length of a connection wire that is used in combination with a jumper bar		7 mm (0.276 in)		
Environmental data				
Ambient temperature range		operation -40 ... +70 °C		
General data				
Material of rail		Cu		
Number of pins		20		
Flammability		V0		

Pluggable interface relays and optocouplers

Technical data – CR-P, CR-M, CR-U

Input circuit - coil data

CR-P range

	Rated control supply voltage U_s	Rated frequency	Make voltage (at 20 °C)	Maximum voltage*	Break voltage	Rated power	Coil resistance (at 20 °C)	Tolerance of coil resistance
DC coils	12 V DC	-	8.4 V DC	30.6 V DC	$\geq 0.1 U_s$	0.4-0.48 W	360 Ω	$\pm 10\%$
	24 V DC	-	16.8 V DC	61.2 V DC	$\geq 0.1 U_s$	0.4-0.48 W	1440 Ω	$\pm 10\%$
	48 V DC	-	33.6 V DC	122.4 V DC	$\geq 0.1 U_s$	0.4-0.48 W	5700 Ω	$\pm 10\%$
	110 V DC	-	77 V DC	280 V DC	$\geq 0.1 U_s$	0.4-0.48 W	25200 Ω	$\pm 10\%$
AC coils	24 V AC	50 / 60 Hz	19.2 V AC	28.8 V AC	$\geq 0.15 U_s$	0.75 VA	400 Ω	$\pm 10\%$
	48 V AC	50 / 60 Hz	38.4 V AC	57.6 V AC	$\geq 0.15 U_s$	0.75 VA	1550 Ω	$\pm 10\%$
	110 V AC	50 / 60 Hz	88 V AC	132 V AC	$\geq 0.15 U_s$	0.75 VA	8900 Ω	$\pm 10\%$
	120 V AC	50 / 60 Hz	96 V AC	144 V AC	$\geq 0.15 U_s$	0.75 VA	10200 Ω	$\pm 10\%$
	230 V AC	50 / 60 Hz	184 V AC	276 V AC	$\geq 0.15 U_s$	0.75 VA	38500 Ω	$\pm 10\%$

CR-P optocouplers range

Input circuit	CR-P024M051	CR-P024TRI1
Input resistance	2200 Ω	1950 Ω
Rated control voltage	24 V DC	24 V DC
Pull-in voltage	10 V DC	10 V DC
Maximum control voltage	32 V DC	32 V DC
Nominal input current	10 mA	12 mA
Input power	260 mW	295 mW
Typical switching-on time	50 ms	< 1/2 cycle
Typical switch-off time	250 ms	< 1/2 cycle

CR-M range

	Rated control supply voltage U_s	Rated frequency	Make voltage (at 20 °C)	Maximum voltage*	Break voltage	Rated power	Coil resistance (at 20 °C)	Tolerance of coil resistance
DC coils	12 V DC	-	9.6 V DC	13.2 V DC	$\geq 0.1 U_s$	0.9 W	160 Ω	$\pm 10\%$
	24 V DC	-	19.2 V DC	26.4 V DC	$\geq 0.1 U_s$	0.9 W	640 Ω	$\pm 10\%$
	48 V DC	-	38.4 V DC	52.8 V DC	$\geq 0.1 U_s$	0.9 W	2600 Ω	$\pm 10\%$
	60 V DC	-	48 V DC	66 V DC	$\geq 0.1 U_s$	0.9 W	4000 Ω	$\pm 10\%$
	110 V DC	-	88 V DC	121 V DC	$\geq 0.1 U_s$	0.9 W	13600 Ω	$\pm 10\%$
	125 V DC	-	100 V DC	137.5 V DC	$\geq 0.1 U_s$	0.9 W	16000 Ω	$\pm 10\%$
	220 V DC	-	176 V DC	242 V DC	$\geq 0.1 U_s$	0.9 W	54000 Ω	$\pm 10\%$
AC coils	24 V AC	50 / 60 Hz	19.2 V AC	26.4 V AC	$\geq 0.2 U_s$	1.6 VA	158 Ω	$\pm 10\%$
	48 V AC	50 / 60 Hz	38.4 V AC	52.8 V AC	$\geq 0.2 U_s$	1.6 VA	640 Ω	$\pm 10\%$
	60 V AC	50 / 60 Hz	48 V AC	66 V AC	$\geq 0.2 U_s$	1.6 VA	930 Ω	$\pm 10\%$
	110 V AC	50 / 60 Hz	88 V AC	121 V AC	$\geq 0.2 U_s$	1.6 VA	3450 Ω	$\pm 10\%$
	120 V AC	50 / 60 Hz	96 V AC	132 V AC	$\geq 0.2 U_s$	1.6 VA	3770 Ω	$\pm 10\%$
	230 V AC	50 / 60 Hz	184 V AC	253 V AC	$\geq 0.2 U_s$	1.6 VA	16100 Ω	$\pm 10\%$

* Refer to CR-U: Operating range of coils

Pluggable interface relays and optocouplers

Technical data – CR-P, CR-M, CR-U

CR-U range

	Rated control supply voltage U_s	Rated frequency	Make voltage (at 20 °C)	Maximum voltage*	Break voltage	Rated power	Coil resistance (at 20 °C)	Tolerance of coil resistance
DC coils	12 V DC	-	9.6 V DC	13.2 V DC	$\geq 0.1 U_s$	1.5 W	110 Ω	$\pm 10 \%$
	24 V DC	-	19.2 V DC	26.4 V DC	$\geq 0.1 U_s$	1.5 W	430 Ω	$\pm 10 \%$
	48 V DC	-	38.4 V DC	52.8 V DC	$\geq 0.1 U_s$	1.5 W	1750 Ω	$\pm 10 \%$
	110 V DC	-	88.0 V DC	121.0 V DC	$\geq 0.1 U_s$	1.5 W	9200 Ω	$\pm 10 \%$
	125 V DC	-	100 V DC	137.5 V DC	$\geq 0.1 U_s$	1.5 W	11000 Ω	$\pm 10 \%$
	220 V DC	-	176.0 V DC	242.0 V DC	$\geq 0.1 U_s$	1.5 W	37000 Ω	$\pm 10 \%$
AC coils	24 V AC	50 / 60 Hz	19.2 V AC	26.4 V AC	$\geq 0.15 U_s$	2.8 VA (50 Hz) 2.5 VA (60 Hz)	75 Ω	$\pm 10 \%$
	48 V AC	50 / 60 Hz	38.4 V AC	52.8 V AC	$\geq 0.15 U_s$	2.8 VA (50 Hz) 2.5 VA (60 Hz)	305 Ω	$\pm 10 \%$
	60 V AC	50 / 60 Hz	48.0 V AC	66.0 V AC	$\geq 0.15 U_s$	2.8 VA (50 Hz) 2.5 VA (60 Hz)	475 Ω	$\pm 10 \%$
	110 V AC	50 / 60 Hz	88.0 V AC	121.0 V AC	$\geq 0.15 U_s$	2.8 VA (50 Hz) 2.5 VA (60 Hz)	1700 Ω	$\pm 10 \%$
	120 V AC	50 / 60 Hz	96.0 V AC	132.0 V AC	$\geq 0.15 U_s$	2.8 VA (50 Hz) 2.5 VA (60 Hz)	1910 Ω	$\pm 10 \%$
	230 V AC	50 / 60 Hz	184.0 V AC	253.0 V AC	$\geq 0.15 U_s$	2.8 VA (50 Hz) 2.5 VA (60 Hz)	7080 Ω	$\pm 10 \%$

* Refer to CR-U: Operating range of coils

Pluggable interface relays and optocouplers

Technical data – CR-P, CR-M, CR-U

Type	CR-P...1	CR-P...2	CR-M...2	CR-M...3	CR-M...4	CR-U...2	CR-U...3	
Output circuit(s)	11-12/14	11-12/14 21-22/24	11-12/14 21-22/24	11-12/14 21-22/24 31-32/34	11-12/14 21-22/24 31-32/34 41-42/44	11-12/14 31-32/34	11-12/14 21-22/24 31-32/34	
Kind of output	Relay, 1 c/o	Relay, 2 c/o	Relay, 2 c/o	Relay, 3 c/o	Relay, 4 c/o	Relay, 2 c/o	Relay, 3 c/o	
Contact material	AgNi	AgNi AgNi/Au 5 µm	AgNi	AgNi	AgNi AgNi/Au 5 µm	AgNi		
Rated operational voltage U_e (VDE 0110, IEC 60947-1)	250 V AC							
Minimum switching voltage	5 V		10 V (AgNi); 5 V (AgNi/Au)			10 V		
Maximum switching voltage	DC 300 V DC		250 V DC					
	AC 440 V AC		250 V AC				440 V AC	
Minimum switching current	5 mA (AgNi), 2 mA (AgNi/Au)		5 mA (AgNi)	5 mA (AgNi)	2 mA (AgNi/Au)	5 mA		
Rated free air thermal current I_{th}	16 A	8 A	12 A	10 A	6 A	10 A		
Rated operational current (IEC 60947-5-1)	AC-12 (resistive) 230 V	16 A	8 A	12 A	10 A	6 A	10 A	
	AC-15 (inductive) 230 V	1.5 A	1.5 A	1.5 A	1.5 A	1 A	1.5 A	
	AC-15 (inductive) 120 V	3 A			1.5 A		3 A	
	DC-12 (resistive) 24 V	16 A	8 A	12 A	10 A	6 A	10 A	
	DC-13 (inductive) 24 V	2.5 A	2 A	2.5 A	2.5 A	2 A	2 A	
	DC-13 (inductive) 120 V	0.22 A						
AC rating (UL 508)	utilization category (pilot duty) (contact rating code designation)	B300		B300			B300	
	max. rated operational voltage	300 V AC		300 V AC			300 V AC	
	max. continuous thermal current at utilization category	5 A		5 A	5 A	2.5 A	5 A	
	max. making / breaking apparent power at utilization category	3600 / 360 VA		3600 / 360 VA			1800 / 180 VA	3600/360 VA
	utilization category (resistive) (CSA22.2 No.14....)	16 A, 250 V AC	8 A, 250 V AC	10 A, 250 V AC 12 A, 150 V AC	6 A, 250 V AC 10 A, 150 V AC	5 A, 250 V AC 10 A, 150 V AC	10 A, 250 V AC (resistive + single-phase)	
	DC rating * (UL 508; NEMA ICS-5)	utilization category (pilot duty) (contact rating code designation)	R300					
max. rated operational voltage		300 V DC						
max. continuous thermal current at utilization category		1 A						
max. making / breaking apparent power at utilization category		28 VA						
utilization category (resistive) (CSA22.2 No.14....)		-	10 A, 24 V DC	-			10 A, 28 V DC	
Maximum making (inrush) current	30 A	15 A	24 A	20 A	12 A	20 A		
Minimum switching power	0.3 W (AgNi), 0.05 W (AgNi/Au)		0.3 W (AgNi), 0.1 W (AgNi/Au)			0.3 W		
Maximum switching (breaking) power	AC1 (resistive)	4000 VA	2000 VA	3000 VA	2500 VA	1500 VA	2500 VA	
Contact resistance	≤ 100 mΩ							
Maximum operating frequency	rated load AC-1	600 switching cycles/h		1200 switching cycles/h				
	without load	72000 switching cycles/h		18000 switching cycles/h			12000 switching cycles/h	

Pluggable interface relays and optocouplers

Technical data – CR-P, CR-M, CR-U

Type		CR-P...1	CR-P...2	CR-M...2	CR-M...3	CR-M...4	CR-U...2	CR-U...3
Mechanical lifetime		> 3 x 10 ⁷ switching cycles		> 2 x 10 ⁷ switching cycles				
Electrical lifetime	electrical AC1 (resistive)	> 0.7 x 10 ⁵ switching cycles (16 A, 250 V)	> 10 ⁵ switching cycles (8 A, 250 V)	> 10 ⁵ switching cycles (12 A, 250 V) (10 A, 250 V) (6 A, 250 V)			> 10 ⁵ switching cycles (12 A, 250 V)	
	cos φ	see reduction factor F						
Response time		typ. 7 ms		typ. 13 ms (DC), 10 ms (AC)			typ. 18 ms (DC), 12 ms (AC)	
Release time		typ. 3 ms		typ. 3 ms (DC), 8 ms (AC)			typ. 7 ms (DC), 10 ms (AC)	
Isolation data								
Rated insulation voltage		400 V AC		250 V AC				
Insulation class (In accordance to VDE 0110b)		C250 / B400		C250 / B250			C250	
Rated impulse withstand voltage U _{imp}	between coil and contacts	5 kV (1.2/50 μs)		2.5 kV (1.2/50 μs)				
	between open contacts	1 kV (1.2/50 μs)		1.5 kV (1.2/50 μs)				
	between c/o (SPDT) contacts	-	2.5 kV (1.2/50 μs)	2.5 kV (1.2/50 μs)		≥ 2 kV (1.2/50 μs)	2 kV (1.2/50 μs)	
Clearance between coil and contacts		≥ 10 mm		≥ 2.5 mm		≥ 1.6 mm	≥ 3 mm	
Creepage distance between coil and contacts		≥ 10 mm		≥ 4 mm		≥ 3.2 mm	≥ 4.2 mm	
Overvoltage category		III		III		II	III	
Pollution degree		3		3		2	3	
General data								
Dimensions		see 'Dimensional drawings'						
Mounting		on socket (see accessories)						
Mounting position		any						
Degree of protection		IP 67		IP 40				
Electrical connection								
Connection		by socket						
Environmental data								
Ambient temperature range	operation	DC: -40...+85 °; AC: -40...+70 °C		DC: -40...+70 °; AC: -40...+55 °C				
	storage	-40 ... +85 °C						
Vibration resistance 10-150 Hz	n/o contact	10 g		5 g		5 g		
	n/c contact	10 g	5 g	5 g		5 g		
Shock resistance	n/o contact	30 g	20 g	10 g		10 g		
	n/c contact	30 g	20 g	5 g		10 g		
Standards / Directives								
Standards		IEC/EN 61810-1						
Low Voltage Directive		-		2014/35/EU				
RoHS Directive		2011/65/EU						

* These ratings are based on different type tests which are not covered by the cULus or CSA approvals.

Pluggable interface relays and optocouplers

Technical data – CR-P optocouplers

Output circuits		CR-P024MOS1	CR-P024TRI1
Output circuit(s)		11 (13+) - 14	11 (13+) - 14
Kind of output		MOS-FET	Triac
Rated operational voltage		24 V DC	240 V AC
Maximum switching voltage		35 V DC	275 V AC
Minimum switching current		1 mA	50 mA
Maximum switching current continuously		5 A	3,5 A
Leakage current at maximum switching voltage		10 uA	1 mA
Voltage drop at rated current		300 mV	1.1 V
Isolation data			
Rated insulation voltage	input/output	2.5 kV	2.5 kV
Insulation class		2	2
Clearance	input/output	19 mm	19 mm
Creepage distance	input/output	19 mm	19 mm
Overvoltage category		III	III
Pollution degree		2	2
General data			
Dimensions		see 'Dimensional drawings'	
Weight		11 g (0.618 lbs)	11 g (0.618 lbs)
Mounting		on socket	on socket
Environmental data			
Ambient temperature	operational	-20...+80 °C	-20...+80 °C
	storage	-40...+100 °C	-40...+100 °C
Standards / Directives			
Standards		IEC/EN 62314	IEC/EN 62314
EMC Directive		2014/30/EU	2014/30/EU
RoHS Directive		2011/65/EU	2011/65/EU

Pluggable interface relays and optocouplers

Technical data - CR-P and CR-M sockets

Output circuits	CR-PLS	CR-PSS	CR-PLC	CR-MxLS	CR-MxSS	CR-MxSF	CR-M4LC	CR-M2LSH	CR-M3LSH	
Output circuit(s)	11-12/14, 21-22/24			11-12/14, 21-22/24, ...				11-12/14, 21-22/24	11-12/14, 21-22/24, 41-42/44	
Number of poles	2			2, 3 or 4		2 or 4	4	2	3	
Rated voltage	250 V AC/DC			250 V AC/DC			300 V AC/DC	250 V AC		
Rated current	2 x 10 A ¹⁾		2 x 10 A ¹⁾	7 A			10 A	12 A	10 A	
General data										
Dimensions without holder and module (L x W x H)	76 x 15.8 x 62 mm (2.992 x 0.622 x 2.441 in)	76 x 15.8 x 42.8 mm (2.992 x 0.622 x 1.685 in)	97.5 x 16.3 x 45.2 mm (3.839 x 0.642 x 1.780 in)	75 x 27.2 x 60.8 mm (2.952 x 1.071 x 2.394 in)	75.2 x 27.2 x 42.6 mm (2.961 x 1.071 x 1.677 in)	66.7 x 30.3 x 29 mm (2.626 x 1.193 x 1.142 in)	95 x 31 x 42.5 mm (3.74 x 1.22 x 1.67 in)	75.5 x 27.2 x 61.1 mm (2.972 x 1.071 x 2.406 in)		
Degree of protection	terminals IP 20 B (EN 60529)									
Temperature range	operation -40...+70 °C						-25...+85 °C		-40...+70 °C	
	storage -40...+70 °C									
Connection type	screw connection		spring connection	screw connection		fork type screw	spring connection	screw connection		
Maximum number of wires per connecting terminal	2		2 (one per connection point)	2		-	2 (one per connection point)	2		
Connecting capacity	rigid	2 x 0.5 - 2.5 mm ² (2 x 20 - 14 AWG)		2 x 0.5 - 2.5 mm ² (2 x 20 - 14 AWG)			2 x 0.5 - 1.5 mm ² (2 x 20 - 16 AWG)	2 x 0.5 - 2.5 mm ² (2 x 20 - 14 AWG)		
	fine-strand	2 x 0.2 - 1.5 mm ² (2 x 24 - 16 AWG)		2 x 0.5 - 1.5 mm ² (2 x 20 - 16 AWG)			2 x 1.5 mm ² (2 x 16 AWG)	2 x 0.5 - 1.5 mm ² (2 x 20 - 16 AWG)		
	with wire end ferrule		2 x 1.5 mm ² (2 x 16 AWG)	2 x 0.5 - 1.5 mm ² (2 x 20 - 16 AWG)			2 x 1.5 mm ² (2 x 16 AWG)	2 x 0.5 - 1.5 mm ² (2 x 20 - 16 AWG)		
Stripping length	7 mm (0.28 in)		11 mm (0.43 in)	7 mm (0.28 in)			10 mm (0.39 in)	7 mm (0.28 in)		
Tightening torque	0.6 Nm (5.31 lb.in)									
Maximum clamping force	with 0,2 mm ²		-	10 N	-	-	-	10 N		
	with 1,5 mm ²		-	40 N	-	-	-	40 N		
	with wire end ferrule		-	-	-	-	-	> 40 N	40 N	
Mounting	DIN rail (IEC/EN 60715)									
Material	socket	PA 6 + GF - UL94 V0			PA 6+GF - UL94 V0			PA 6+GF - UL94 V0		
	contacts	CuZn33			CuZn33			Copper alloy		
	contact surface	5 μ Ni	5 μ Ni		5 μ Ni	6 μ Ni	5 μ tinned	5 μ Ni		
	terminals	8 μ Ni	8 μ Ni	XCrNi Steel	8 μ Ni		CCSC	5 μ Ni		
	combi screw M3	8.8 Steel, 5μ Ni		-	8.8 Steel, 5μ Ni			-	2 μ Ni	
Isolation data										
Insulation voltage	> 5 kV			> 3 kV			> 4 kV	> 2 kV		
Isolation between coil and contacts	IEC/EN 61984							> 1000 MΩ		
Clearance and creepage distance	IEC/EN 61984									
Standards / Directives										
Standards	IEC/EN 61984							IEC 61984		
Low Voltage Directive	2014/35/EU									
RoHS Directive	2011/65/EU									

¹⁾ Loads >10 A (>12 A for CR-PLSx) require jumpering of terminal 11 with 21, 12 with 22, and 14 with 24

Pluggable interface relays and optocouplers

Technical data - CR-P and CR-M jumper bars, CR-P and CR-M function modules

Rated operational voltage / Rated current		CR-PJ	CR-MJ
Rated operational voltage (VDE 0660 / part 500)		400 V	
Rated current (VDE 0660 / part 500)		25 A	
Electrical connection			
Bus bar diameter		6 mm ² (0.0093 in ²)	
Step distance		15.5 mm (0.610 in)	27.2 mm (1.071 in)
Rail length		with isolation	150 mm (5.906 in)
		without isolation	141.5 mm (5.571 in)
Stripping length of a connection wire that is used in combination with a jumper bar		6 mm (0.236 in)	
Environmental data			
Ambient temperature range		operation	-40... +55 °C
Isolation data			
Rated impulse withstand voltage U _{imp} (VDE 0660 / part 500)		4 kV (1.2/50 μs)	
Overvoltage category (IEC/EN 60664)		III	
Pollution degree (IEC/EN 60664)		2	
General data			
Material of rail		E-Cu-F25	
Type of rail		pin type	
Number of pins		10	
Number of phases		1	
Color of insulating material		RAL 7035	
Flammability (UL 94)		V0	

Technical data - CR-P and CR-M function modules

CR-P/M 22						
Type	CR-P/M 22					
Version	Diode					
Function	Reverse polarity protection					
Control supply voltage	6-220 V DC					
Component data	diode	1 A, 1000 V				
Polarized	yes (A1+, A2-)					
Material	enclosure / base	PA6 + GF - UL94 V0				
CR-P/M 42						
Type	CR-P/M 42	CR-P/M 42V	CR-P/M 42B	CR-P/M 42BV	CR-P/M 42C	CR-P/M 42CV
Version	Diode and LED					
Function	Reverse polarity protection / free-wheeling diode and LED to indicate energized coil					
Control supply voltage	6-24 V DC		24-60 V DC		110 V DC	
Component data	diode	1 A, 1000 V				
	LED	red	green	red	green	red
	resistance	3 kΩ, 0.25 W		15 kΩ, 0.25 W		200 kΩ, 0.25 W
Polarized	yes (A1+, A2-)					
Material	enclosure / base	PA6 + GF - UL94 V0				
CR-P/M 52						
Type	CR-P/M 52B		CR-P/M 52D		CR-P/M 52C	
Version	RC element					
Function	Spark quenching					
Control supply voltage	6-24 V AC/DC		24-60 V AC/DC		110-230 V AC/DC	
Component data	capacitor	0.1 μF, 63 V DC		0.1 μF, 100 V DC		0.082 μF, 400 V DC
	resistance	10 Ω, 0.25 W		47 Ω, 0.25 W		100 Ω, 0.25 W
Polarized	no					
Material	enclosure / base	PA6 + GF - UL94 V0				

Pluggable interface relays and optocouplers

Technical data - CR-P and CR-M function modules

CR-P/M 62									
Type	CR-P/M 62	CR-P/M 62V	CR-P/M 62E	CR-P/M 62EV	CR-P/M 62C	CR-P/M 62CV	CR-P/M 62D	CR-P/M 62DV	
Version	Diode and LED				Varistor and LED				
Function	LED to indicate energized coil				Overvoltage protection and LED to indicate energized coil				
Control supply voltage	6-24 V AC/DC		24-60 V AC/DC		6-24 V AC/DC		24-60 V AC/DC		
Component data	diode	1 A, 1000 V							
	LED	red	green	red	green	red	green	red	green
	varistor	25 V AC		75 V AC		25 V AC		75 V AC	
	resistance	3 k Ω , 0.25 W		15 k Ω , 0.25 W		3 k Ω , 0.25 W		15 k Ω , 0.25 W	
Polarized	AC: no, DC: yes (A1+, A2-)								
Material	enclosure / base	PA6 + GF - UL94 V0							
CR-P/M 72, 82									
Type	CR-P/M 72			CR-P/M 72A		CR-P/M 82			
Version	Varistor								
Function	Overvoltage protection								
Control supply voltage	24 V AC			115 V AC		230 V AC			
Component data	varistor	25 V AC			115 V AC		275 V AC		
Polarized	no								
Material	enclosure / base	PA6 + GF - UL94 V0							
CR-P/M 92									
Type	CR-P/M 92		CR-P/M 92V		CR-P/M 92C		CR-P/M 92CV		
Version	Diode and LED				Varistor and LED				
Control supply voltage	110-230 V AC/DC								
Function	LED to indicate energized coil				Overvoltage protection and LED to indicate energized coil				
Component data	diode	1 A, 1000 V							
	LED	red	green		red	green			
	varistor	275 V AC							
	resistance	120 k Ω , 0.25 W							
Polarized	AC: no, DC: yes (A1+, A2-)								
Material	enclosure / base	PA6 + GF - UL94 V0							
Standards / Directives									
Standards	IEC/EN 61984								
Low Voltage Directive	2014/35/EU								
RoHS Directive	2011/65/EU								

Pluggable interface relays and optocouplers

Technical data - CR-U sockets and function modules

Output circuits		CR-U2S	CR-U3S	CR-UxSM
Output circuit(s)		11-12/14, 21-22/24,...		
Number of poles		2	3	2 or 3
Rated voltage		250 V AC		250 V AC
Rated current		10 A		
General data				
Dimensions		see 'Dimensional drawings'		
Degree of protection	terminals	IP 20 B (EN 60529)		
Temperature range	operation	-40...+70 °C		-40...+70 °C
	storage	-40...+70 °C		-40...+70 °C
Connecting capacity	rigid	2 x 2 x 0,5 - 2,5 mm ² (2 x 20 - 14 AWG)		
	fine-strand			
	with wire end ferrule	2 x 0.5 - 1.5 mm ² (2 x 20 - 16 AWG)		2 x 0.5 - 1.5 mm ² (2 x 20 - 16 AWG)
Stripping length		7 mm (0.28 in)		
Tightening torque		0.6 Nm		0.6 Nm
Mounting		DIN rail (IEC/EN 60715)		
Material	socket	PA 6+GF - UL94 V0		
	contacts	CuZn33		
	contact surface	6 μ Ni		3 μ Ni
	terminals	8 μ Ni		10 μ Ni
	combi screw M3	8.8 steel, 5μ Ni		Steel, 8 μ Ni
Isolation data				
Insulation voltage		> 2 kV		
Isolation between coil and contacts		IEC/EN 61984		
Clearance and creepage distance		IEC/EN 61984		
Standards/Directives				
Standards		IEC/EN 61984		
Low Voltage Directive		2014/35/EU		
RoHS Directive		2011/65/EU		

Technical data - CR-U function modules

CR-U 21						
Type	CR-U 21					
Version	Diode					
Function	Reverse polarity / free-wheeling diode					
Control supply voltage	6-220 V DC					
Component data	Diode	1 A, 1000 V				
Polarized	yes (A1+, A2-)					
Material	Enclosure / Base	PA6 + GF - UL94 V0				
CR-U 41						
Type	CR-U 41	CR-U 41V	CR-U 41B	CR-U 41BV	CR-U 41C	CR-U 41CV
Version	Diode and LED					
Function	Reverse polarity / free-wheeling diode and LED to indicate energized coil					
Control supply voltage	6-24 V DC		24-60 VDC		110 V DC	
Component data	Diode	1 A, 1000 V				
	LED	red	green	red	green	red
	Resistance	3 kΩ, 0.25 W		15 kΩ, 0.25 W		200 kΩ, 0.25 W
Polarized	yes (A1+, A2-)					
Material	Enclosure / Base	PA6 + GF - UL94 V0				

Pluggable interface relays and optocouplers

Technical data - CR-U function modules

CR-U 51									
Type	CR-U 51B			CR-U 51D			CR-U 51C		
Version	RC element								
Function	Spark quenching								
Control supply voltage	6-24 V AC/DC			24-60 V AC/DC			110-230 V AC/DC		
Component data	Capacitor	0.1 μ F, 63 V DC			0.1 μ F, 100 V DC			0.082 μ F, 400 V DC	
	Resistance	10 Ω , 0.25 W			47 Ω , 0.25 W			100 Ω , 0.25 W	
Polarized	no								
Material	Enclosure / Base	PA6 + GF - UL94 V0							
CR-U 61									
Type	CR-U 61	CR-U 61V	CR-U 61E	CR-U 61EV	CR-U 61C	CR-U 61CV	CR-U 61D	CR-U61DV	
Version	Diode and LED					Varistor and LED			
Function	Reverse polarity protection / free-wheeling diode and LED to indicate energized coil					Overvoltage protection and LED to indicate energized coil			
Control supply voltage	6-24 V AC/DC			24-60 V AC/DC		6-24 V AC/DC		24-60 V AC/DC	
Component data	Diode	1 A, 1000 V							
	LED	red	green	red	green	red	green	red	green
	Resistance	3 k Ω , 0.25 W			15 k Ω , 0.25 W		3 k Ω , 0.25 W		15 k Ω , 0.25 W
Polarized	AC: no, DC: yes (A1+, A2-)								
Material	Enclosure / Base	PA6 + GF - UL94 V0							
CR-U 71, 81									
Type	CR-U 71			CR-U 71A			CR-U 81		
Version	Varistor								
Function	Overvoltage protection								
Control supply voltage	24 V AC			115 V AC			230 V AC		
Component data	Varistor	25 V AC			115 V AC			275 V AC	
Polarized	no								
Material	Enclosure / Base	PA6 + GF - UL94 V0							
CR-U 91									
Type	CR-U 91			CR-U 91V			CR-U 91C		CR-U 91CV
Version	Diode and LED					Varistor and LED			
Function	LED to indicate energized coil					Overvoltage protection and LED to indicate energized coil			
Control supply voltage	110-230 V AC/DC								
Component data	Diode	1 A, 1000 V							
	LED	red			green		red		green
	Resistance	120 k Ω , 0.25 W							
Polarized	AC: no, DC: yes (A1+, A2-)								
Material	Enclosure / Base	PA6 + GF - UL94 V0							
Standards / Directives									
Standards	IEC/EN 61984								
Low Voltage Directive	2014/35/EU								
RoHS Directive	2011/65/EU								

Pluggable interface relays and optocouplers

Technical diagrams

Connection diagrams

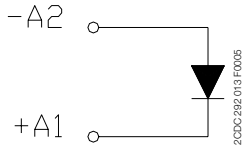

CR-P/M 22

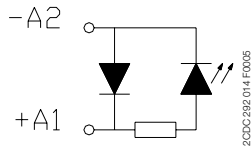

CR-P/M 42, CR-P/M 42B,
CR-P/M 42C, CR-P/M 42V,
CR-P/M 42BV, CR-P/M 42CV

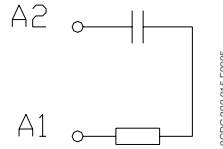

CR-P/M 52B, CR-P/M 52C
CR-P/M 52D,

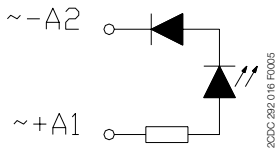

CR-P/M 62, CR-P/M 62E,
CR-P/M 92, CR-P/M 62V,
CR-P/M 62EV, CR-P/M 92V

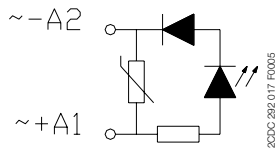

CR-P/M 62C, CR-P/M 62D,
CR-P/M 92C, CR-P/M 62CV,
CR-P/M 62DV, CR-P/M 92CV

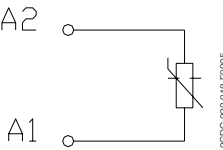

CR-P/M 72, CR-P/M 82
CR-P/M 72A,

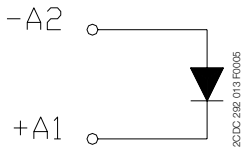

CR-U 21

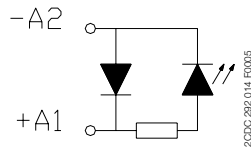

CR-U 41, CR-U 41B, CR-U 41C,
CR-U 41V, CR-U 41BV, CR-U 41CV

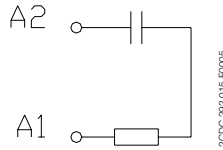

CR-U 51B, CR-U 51C CR-U 51D

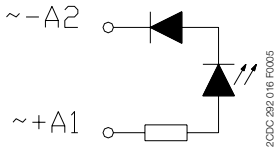

CR-U 61, CR-U 61E, CR-U 91,
CR-U 61V, CR-U 61EV, CR-U 91V

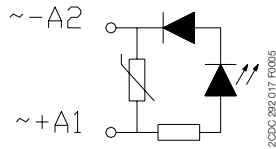

CR-U 61C, CR-U 61CV, CR-U 61D,
CR-U 61DV, CR-U 91C, CR-U 91CV

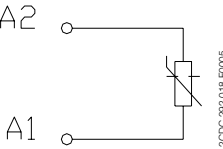

CR-U 71, CR-U 71A, CR-U 81

Pluggable interface relays and optocouplers

Technical diagrams

Connection diagrams

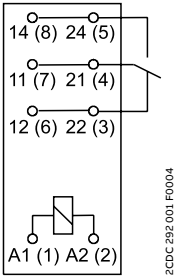

2CDC 292 001 F0004

CR-P with 1 c/o contact

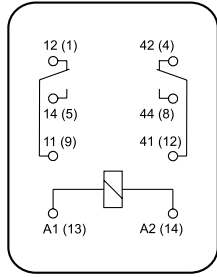

2CDC 292 011 F0004

CR-M with 2 c/o contacts

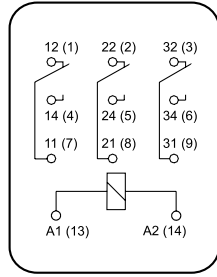

2CDC 292 016 F0004

CR-M with 3 c/o contacts

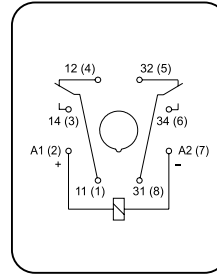

2CDC 292 024 F0004

CR-U with 2 c/o contacts

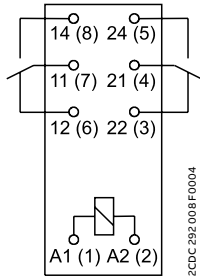

2CDC 292 008 F0004

CR-P with 2 c/o contacts

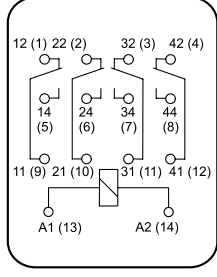

2CDC 292 020 F0004

CR-M with 4 c/o contacts

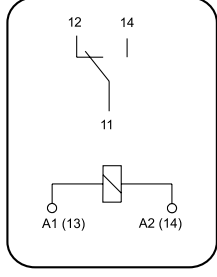

2CDC 292 001 F0014

CR-S

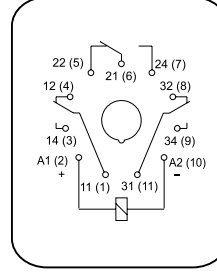

2CDC 292 030 F0004

CR-U with 3 c/o contacts

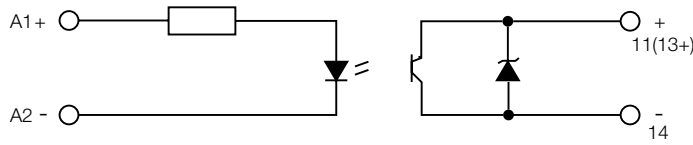

2CDC 292 001 F0016

CR-S optocoupler with Transistor

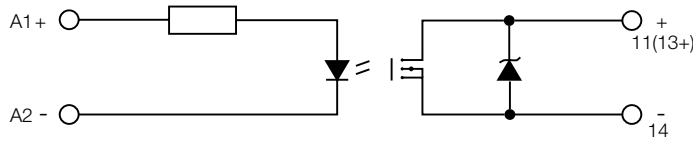

2CDC 292 002 F0016

CR-S optocoupler with MOSFET

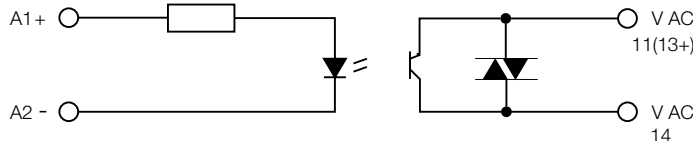

2CDC 292 001 F0016

CR-S optocoupler with Triac

Pluggable interface relays and optocouplers

Technical diagrams

CR-P: Operating range of coils

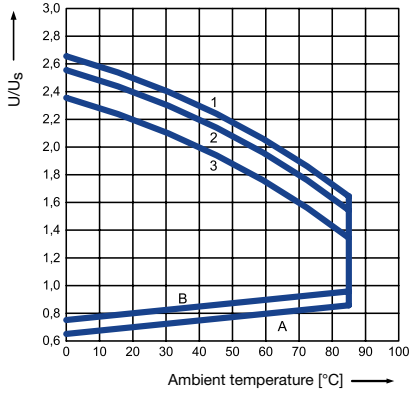

Operating range of DC coil

2CDC292.037.F0204

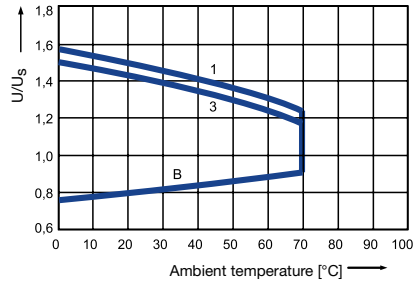

Operating range of AC coil

2CDC292.038.F0204

- A unloaded contacts, coil temperature = ambient temperature
- B continued with I_{th} (16 A at CR-P ... 1 and 8 A at CR-P ... 2) loaded contacts coil heated with $1,1 \times U_s$
- 1 at unloaded contacts
- 2 at 50 % rated load
- 3 at rated load

CR-M: Operating range of coils

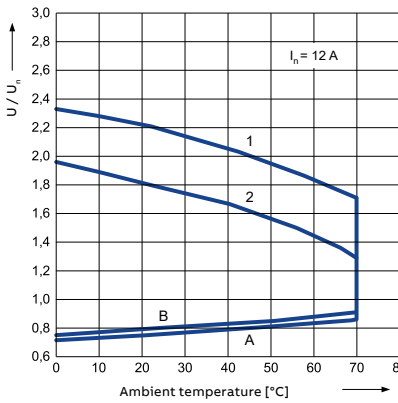

Operating range of DC coil – 2 c/o

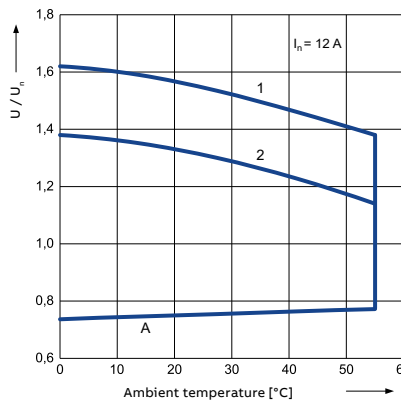

Operating range of AC coil – 2 c/o

- A relations between make voltage and ambient temperature at no load on contacts. Coil temperature and ambient temperature are equal before coil energizing. Make voltage is not higher than the value read on Y axis (multiplication of rated voltage)
- B relations between make voltage and ambient temperature after initial coil heating up with $1,1 U_s$, at continues load of I_n on contacts. Make voltage is not higher than the value read on Y axis (multiplication of rated voltage)
- 1, 2 values on Y axis represent allowed overvoltage on coil at certain ambient temperature and contact load:
- 1 no load
- 2 rated load

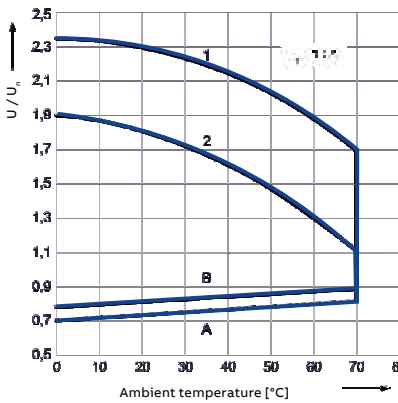

Operating range of DC coil – 3 c/o

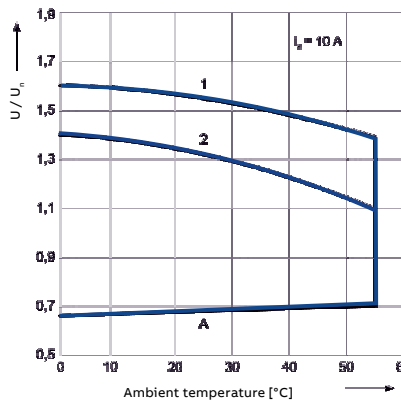

Operating range of AC coil – 3 c/o

Pluggable interface relays and optocouplers

Technical diagrams

CR-M: Operating range of coils

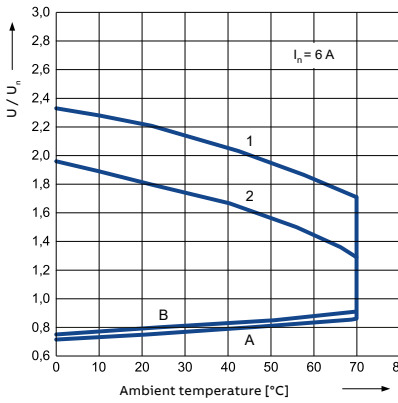

Operating range of DC coil – 4 c/o

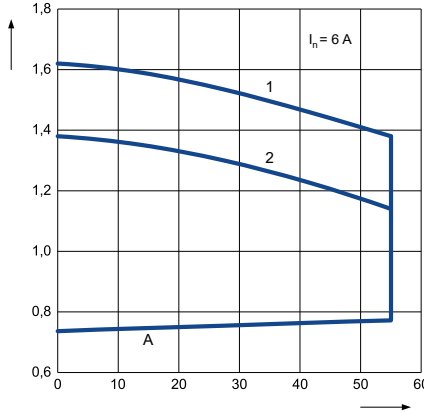

Operating range of AC coil – 4 c/o

CR-U: Operating range of coils

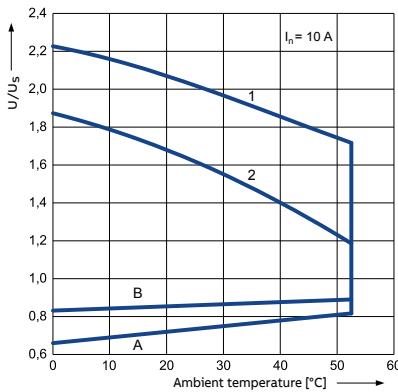

Operating range of DC coil - 3 c/o

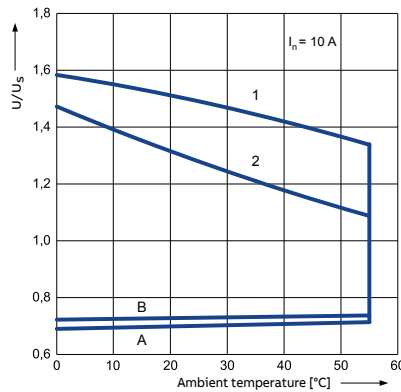

Operating range of AC coil - 3 c/o

- A relations between make voltage and ambient temperature at no load on contacts. Coil temperature and ambient temperature are equal before coil energizing. Make voltage is not higher than the value read on Y axis (multiplication of rated voltage)
- B relations between make voltage and ambient temperature after initial coil heating up with $1,1 U_n$ at continues load of I_n on contacts. Make voltage is not higher than the value read on Y axis (multiplication of rated voltage)
- 1,2 values on Y axis represent allowed overvoltage on coil at certain ambient temperature and contact load:
- 1 no load
- 2 rated load

Electrical connection

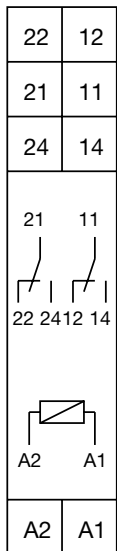

CR-PLS

2CDC 292 063 F0 004

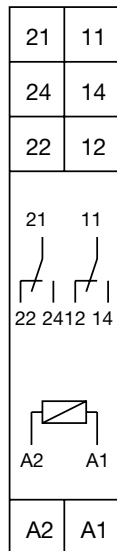

CR-PLSx, CR-PLC

2CDC 292 063 F0 004

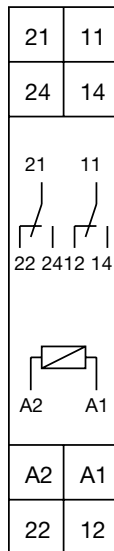

CR-PSS

2CDC 292 009 F0 007

A1-A2	Supply voltage
11-12/14,	Relay outputs
21-22/24	Relay outputs

Pluggable interface relays and optocouplers

Technical diagrams

Mounting and removal of sockets

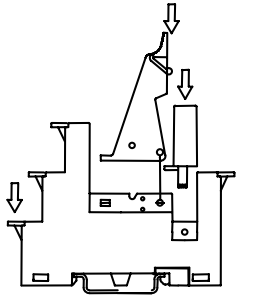

2CDC 292 061 F0004

Mounting

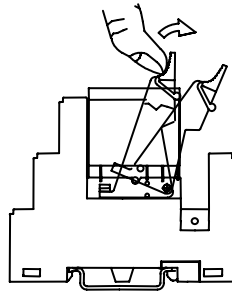

2CDC 292 062 F0004

Removal

Electrical connection

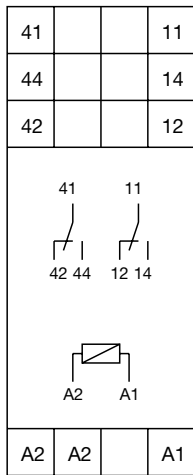

2CDC 292 075 F0004

CR-M2LS(H)

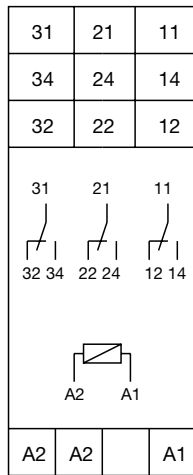

2CDC 292 074 F0004

CR-M3LS(H)

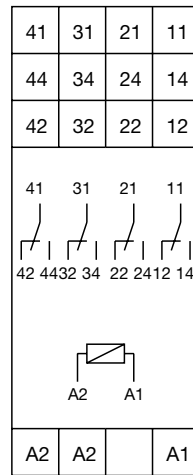

2CDC 292 073 F0004

CR-M4LS

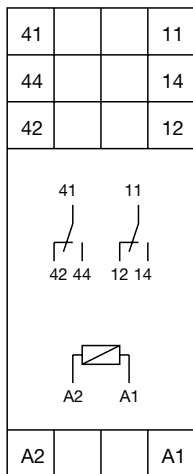

2CDC 292 008 F0004

CR-M2LC

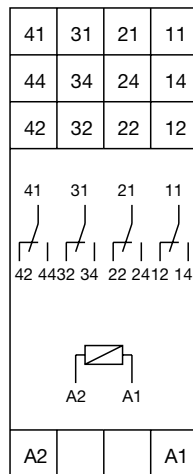

2CDC 292 008 F0004

CR-M4LC

Pluggable interface relays and optocouplers

Technical diagrams

Electrical connection

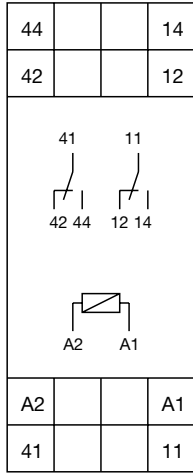

CR-M2SS,
CR-M2SF

A1-A2	Supply voltage
11-12/14,	Relay outputs
41-42/44	Relay outputs

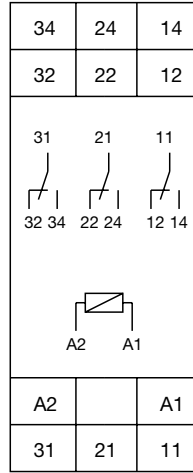

CR-M3SS

A1-A2	Supply voltage
11-12/14,	Relay outputs
21-22/24,	Relay outputs
31-32/34	Relay outputs

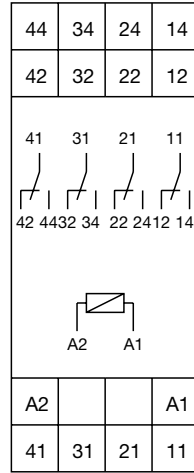

CR-M4SS,
CR-M4SF

A1-A2	Supply voltage
11-12/14,	Relay outputs
21-22/24	Relay outputs
31-32/34	Relay outputs
41-42/44	Relay outputs

Pluggable interface relays and optocouplers

Technical diagrams

Technical diagrams CR-S interface relays

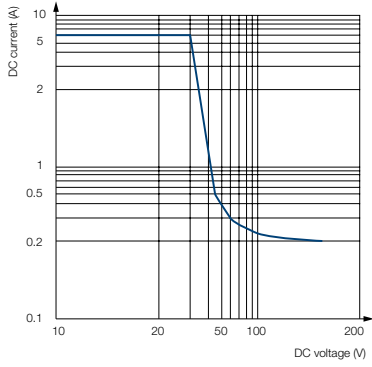

2CDC292.012 F0214

Max. DC load breaking capacity

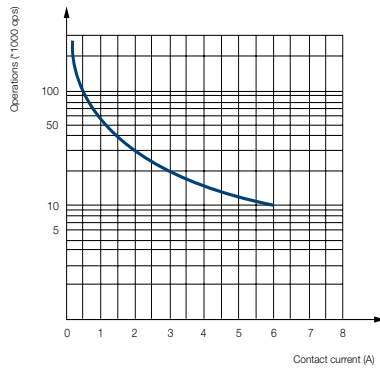

2CDC292.013 F0214

Endurance curve

Load limit curves CR-P, CR-M and CR-U - Electrical lifetime at resistive AC load

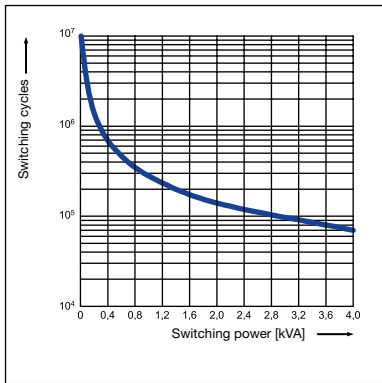

2CDC92009F0204

CR-P with 1 c/o contact

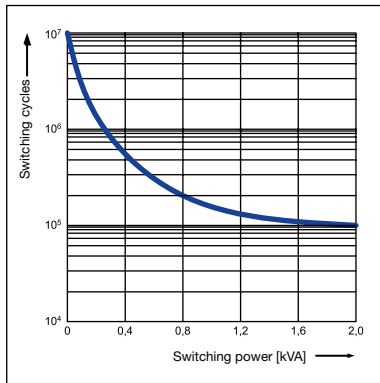

2CDC92009F0204

CR-P with 2 c/o contacts

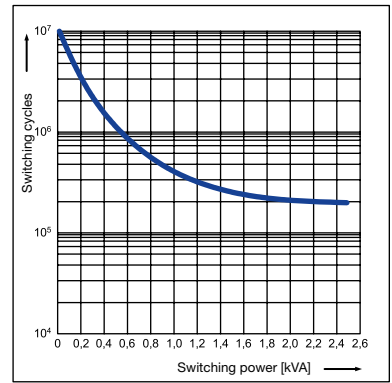

2CDC92027F0204

CR-U with 2 and 3 c/o contacts

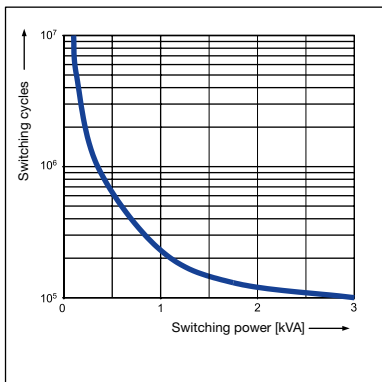

2CDC29203F0204

CR-M with 2 c/o contacts

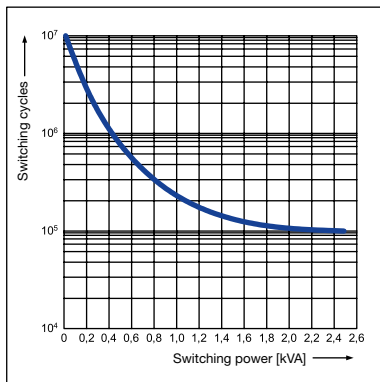

2CDC292018F0204

CR-M with 3 c/o contacts

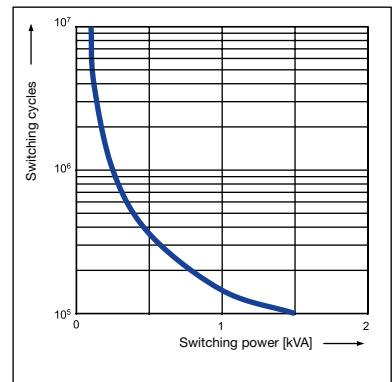

2CDC92022F0204

CR-M with 4 c/o contacts

Pluggable interface relays and optocouplers

Technical diagrams

Load limit curves CR-P, CR-M and CR-U - Maximum switching power at resistive DC load

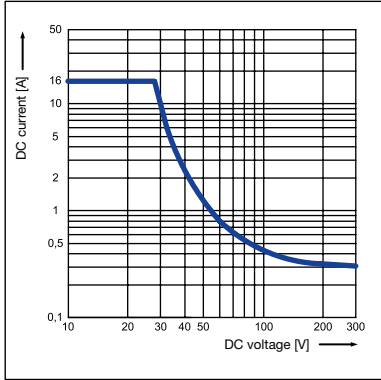

2CDC292009F0204

CR-P with 1 c/o contact

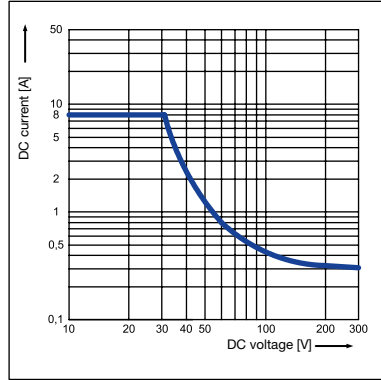

2CDC292010F0204

CR-P with 2 c/o contacts

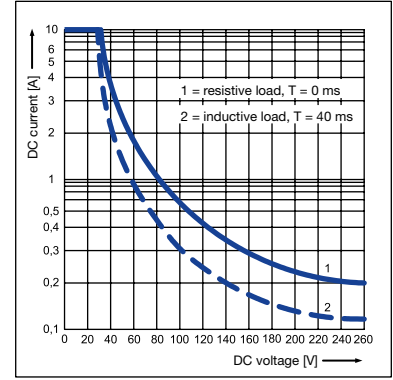

2CDC292029F0204

CR-U with 2 and 3 c/o contacts

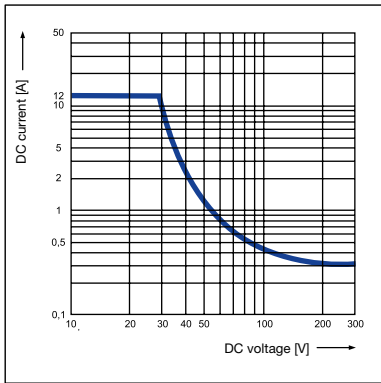

2CDC292015F0204

CR-M with 2 c/o contacts

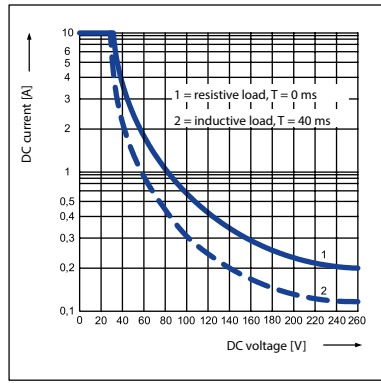

2CDC292019F0204

CR-M with 3 c/o contacts

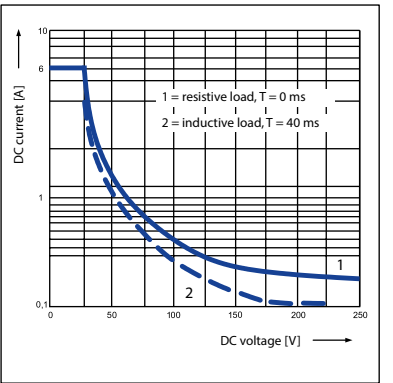

2CDC292023F0204

CR-M with 4 c/o contacts

Reduction factor CR-P, CR-M and CR-U – F at inductive AC load

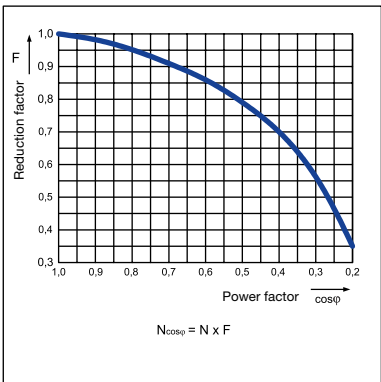

2CDC292004F0204

CR-P

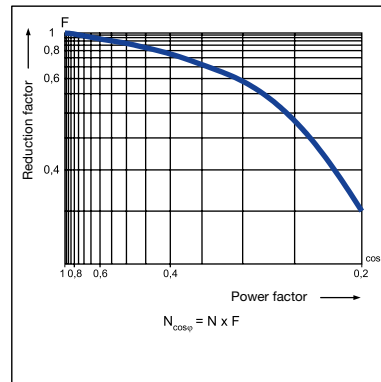

2CDC292014F0204

CR-M

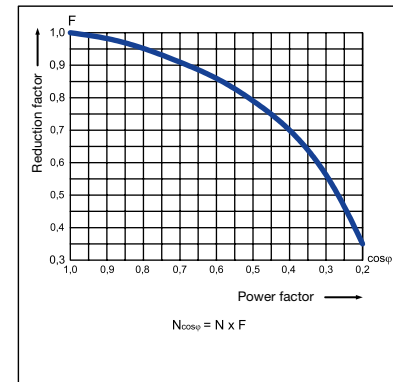

2CDC292029F0204

CR-U

Pluggable interface relays and optocouplers

Technical diagrams

Derating curves

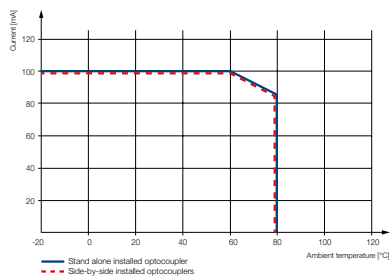

Derating curve Transistor output CR-S

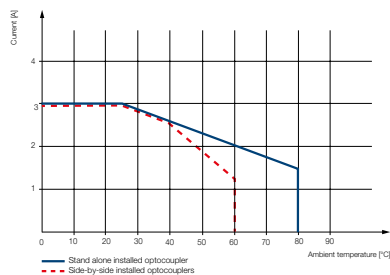

Derating curve MOS-FET output CR-S

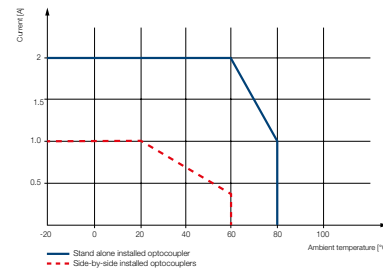

Derating curve Triac output CR-S

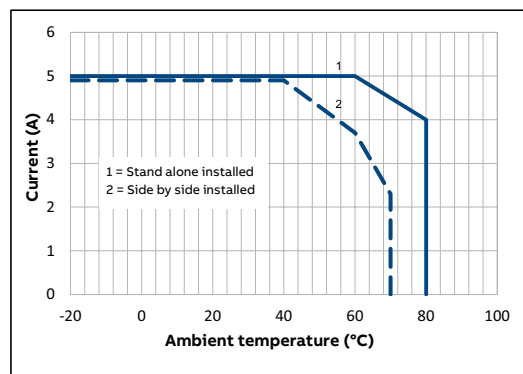

MOS-FET output CR-P

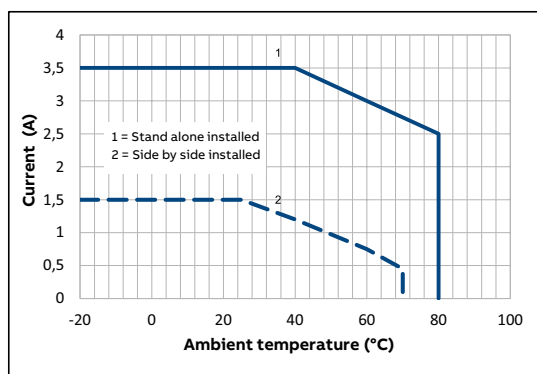

Triac output CR-P

Pluggable interface relays and optocouplers

Technical diagrams

Dimensional drawings in mm and inches

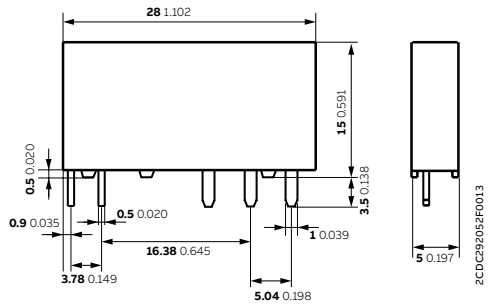

CR-S relay

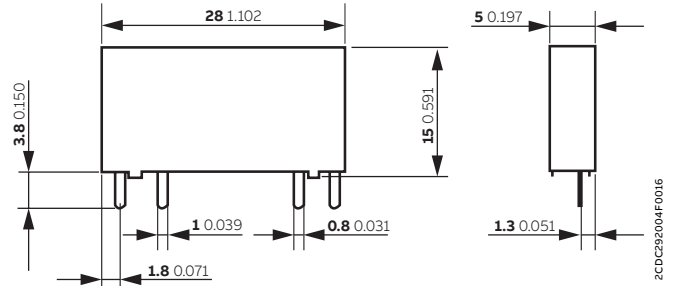

CR-S optocoupler

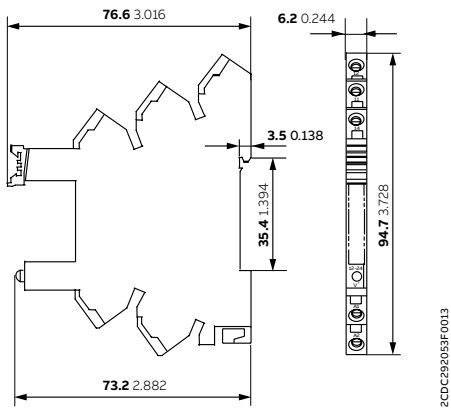

CR-S socket - spring connection

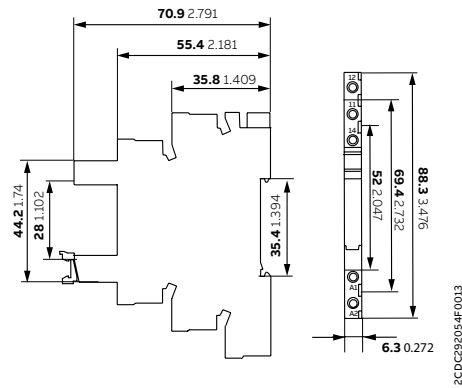

CR-S socket - screw connection

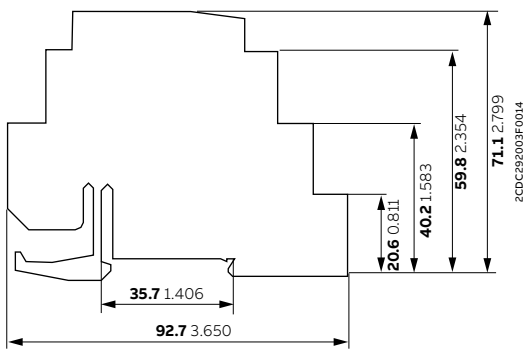

CR-S separator

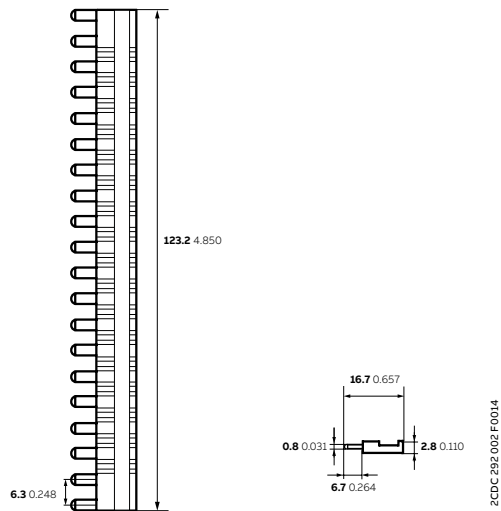

CR-SJB20 - blue, CR-SJB20 - red, CR-SJB20 - black jumper bar

Pluggable interface relays and optocouplers

Technical diagrams

Dimensional drawings in mm and inches

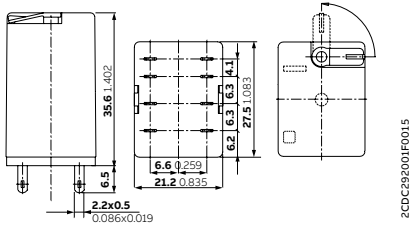

CR-M relay with 2 c/o contacts

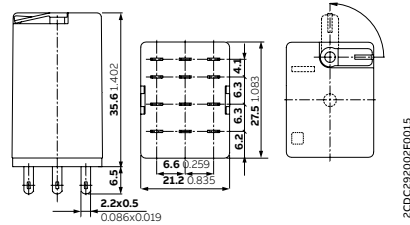

CR-M relay with 3 c/o contacts

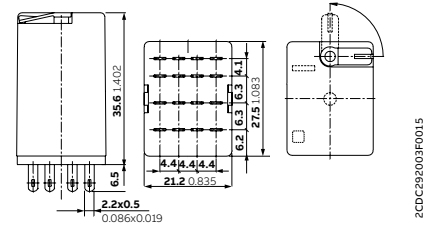

CR-M relay with 4 c/o contacts

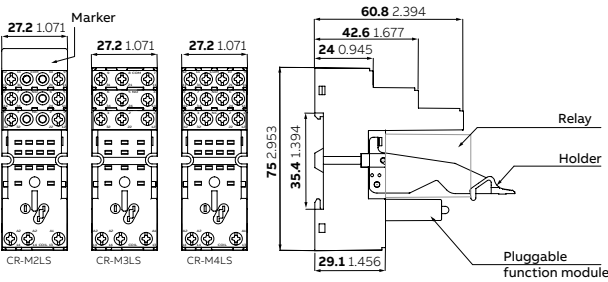

CR-M2LS(H) - CR-M3LS(H) - CR-M4LS - screw connection

2CDC292003F0011

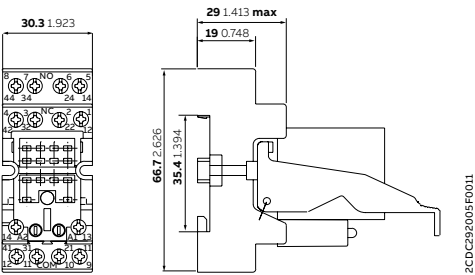

CR-MxSF - screw connection

2CDC292005F0011

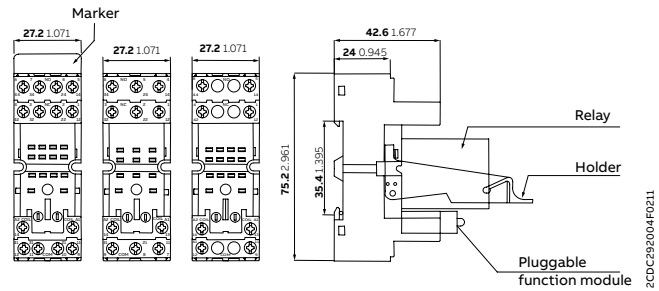

CR-M2SS - CR-M3SS - CR-M4SS - screw connection

2CDC292004F0011

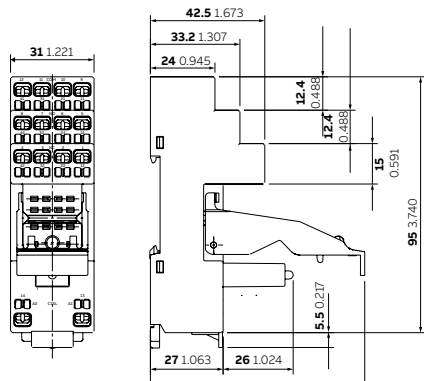

CR-M4LC - spring connection

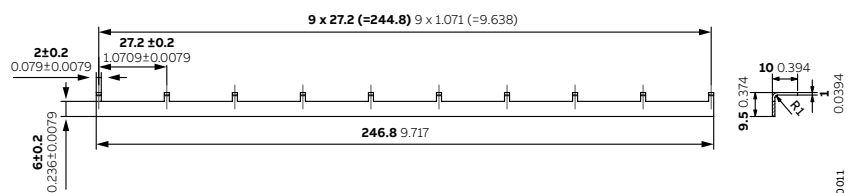

CR-MJ jumper bar

2CDC292011F0011

Pluggable interface relays and optocouplers

Technical diagrams

Dimensional drawings in mm and inches

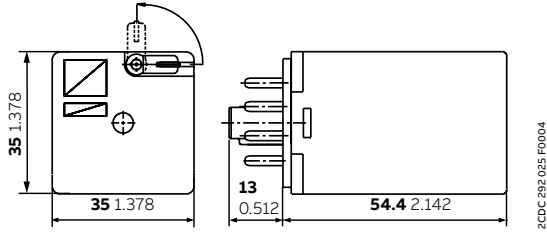

CR-U relay with 2 c/o contacts

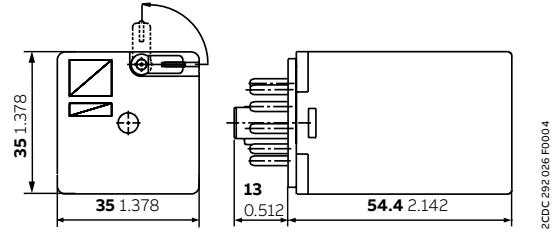

CR-U relay with 3 c/o contacts

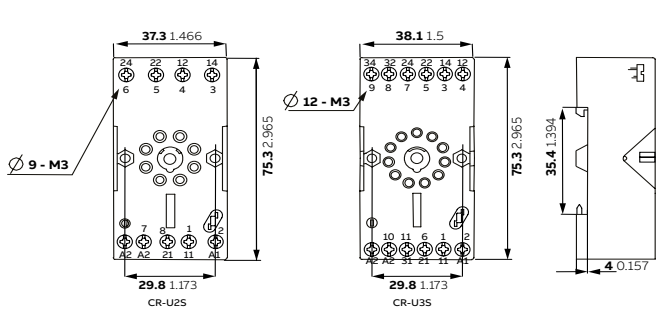

CR-U25 - CR-U35 - screw connection

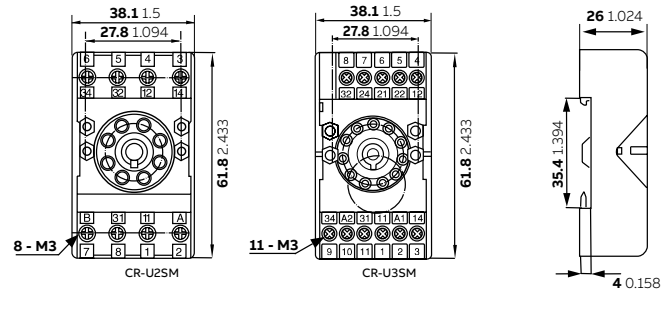

CR-U25M - CR-U35M - screw connection

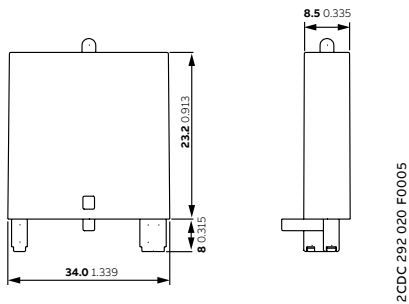

CR-Uxx function module



Boxed interface relays and optocouplers R600 range

Table of contents

480	Overview
482	Boxed interface relays R600 range
482	Selection table
484	Ordering details
486	Technical data
490	Technical diagrams
492	Boxed optocouplers R600 range
492	Selection table
493	Ordering details
495	Technical data
498	Technical diagrams

Boxed interface relays and optocouplers R600 range

Overview



ABB's R600 range may be used in applications where electrical isolation, amplification and signal matching are required. The slim, compact design, incorporated with the variety of terminal connections available allow for the optimization of space within a control panel. This broad portfolio allows for the flexibility of choice and includes both electromagnetic relays and optocouplers.

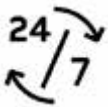

Continuous operation

The ABB boxed interface relays portfolio incorporates a large assortment of non-pluggable relays. It includes both electro-mechanical relays and optocouplers. The R600 Optocouplers allow for continuous operation without any mechanical wear-and-tear.

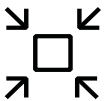

Space saving

The 6 mm slim housing of the R600 boxed interface relays provides the possibility of space saving within control cabinets. The 75 mm depth of these relays allows for the use in compact cabinets.



Global availability

The ABB boxed interface relays are approved for a large variety of applications and adhere to highest levels of global approvals (UL, CSA, VDE, CCC).

Boxed interface relays and optocouplers R600 range

Overview

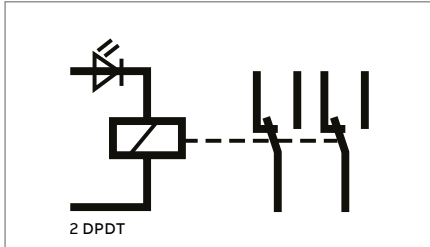

Complete product line

1 n/o, 1 n/c, 1 c/o, 2 c/o output configuration. Standard contact material for switching high current signals as well as gold-plated contacts for reliable switching of low current signals.



Marine certification

The R600 range offers the LR approval, which allows usage of the boxed interface relays and optocouplers in many applications around the marine segment. The performance of the R600 range has been proven by successfully passing tests required for operating under harsh conditions.

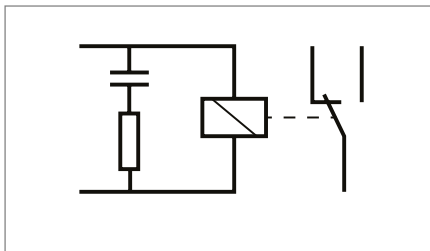

Safe operation

High resistance to vibration and shock thanks to the relay soldered inside of the housing. Wrong relay replacement or relay lose not possible. Devices with immunity to leakage currents.

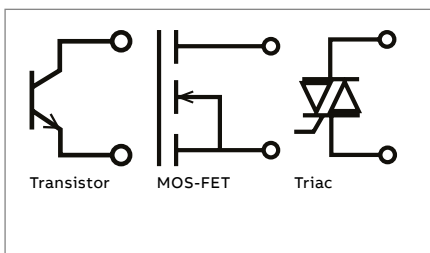

Longevity

Optocoupler with transistor, MOS-FET and Triac output ensure a longer lifetime, higher reliability and quiet operation.

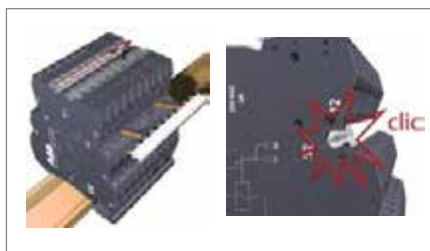

Easy to mount

The R600 interface relays and optocouplers are easy to mount by snapping onto a DIN-rail according to IEC/EN 60715. Time saving wiring thanks to a jumper bar.

Boxed interface relays R600 range

Ordering details



R600 - 6 mm

2CDC 291 024 50013

The R600 range comprises of boxed interface relays and optocouplers. In this range, the relay is soldered into device housing, fulfilling the highest vibration requirements. This compact range of relays are 6 mm wide and provide the possibility of switching AC and DC circuits with the same relay. All the sockets in this range are equipped with an indicator LED and available with screw or spring terminals.

Ordering details - 1 n/c contact: 250 V AC, 10 mA - 6 A, width 12 mm

Rated control supply voltage	Connection type	Particularities	Type	Order code	Pkg qty	Weight (1 pc.) kg (lb)
24 V AC/DC	screw	RC circuit parallel to output contact	RB101R-24VUC	1SNA645019R0400	5	0.04 (0.088)
	spring		RBR101R-24VUC	1SNA645519R0600		

Ordering details - 1 n/o contact: 250 V AC, 10 mA - 6 A, width 6 mm

Rated control supply voltage	Connection type	Particularities	Type	Order code	Pkg qty	Weight (1 pc.) kg (lb)
24 V AC/DC	screw		RB111-24VUC	1SNA645014R2700	10	0.02 (0.044)
115 V AC/DC	screw		RB111-115VUC	1SNA645016R2100		
230 V AC/DC	screw		RB111-230VUC	1SNA645017R2200		
24 V AC/DC	spring		RBR111-24VUC	1SNA645514R2100		

Ordering details - 1 n/o contact: 250 V AC, 10 mA - 6 A, width 12 mm

Rated control supply voltage	Connection type	Particularities	Type	Order code	Pkg qty	Weight (1 pc.) kg (lb)
24 V AC/DC	screw	RC circuit parallel to output contact	RB111R-24VUC	1SNA645018R0300	5	0.04 (0.088)
	spring		RBR111R-24VUC	1SNA645518R0500		

Ordering details - 1 c/o (SPDT) contact: 250 V AC, 10 mA - 6 A, width 6 mm

Rated control supply voltage	Connection type	Particularities	Type	Order code	Pkg qty	Weight (1 pc.) kg (lb)
5 V DC	screw	A1-A2 polarized	RB121P-5VDC	1SNA645034R2300	10	0.02 (0.044)
12 V DC	screw	A1-A2 polarized	RB121P-12VDC	1SNA645035R2400		
12 V DC	screw		RB121-12VDC	1SNA645073R0000		
24 V DC	screw		RB121-24VDC	1SNA645071R0000		
24 V AC/DC	screw		RB121-24VUC	1SNA645001R0300		
48-60 V AC/DC	screw		RB121-48-60VUC	1SNA645002R0400		
115 V AC/DC	screw		RB121-115VUC	1SNA645003R0500		
230 V AC/DC	screw		RB121-230VUC	1SNA645004R0400		
5 V DC	spring	A1-A2 polarized	RBR121P-5VDC	1SNA645534R2500		
12 V DC	spring	A1-A2 polarized	RBR121P-12VDC	1SNA645535R2600		
24 V DC	spring		RBR121-24VDC	1SNA645571R0000		
24 V AC/DC	spring		RBR121-24VUC	1SNA645501R0500		
48-60 V AC/DC	spring		RBR121-48-60VUC	1SNA645502R0600		
115 V AC/DC	spring		RBR121-115VUC	1SNA645503R0700		
230 V AC/DC	spring		RBR121-230VUC	1SNA645504R0000		

Boxed interface relays R600 range

Ordering details

Ordering details - 1 c/o (SPDT) contact: 250 V AC, 3 mA - 6 A, gold-plated contacts, width 6 mm

Rated control supply voltage	Connection type	Particularities	Type	Order code	Pkg qty	Weight (1 pc.) kg (lb)
5 V DC	screw	A1-A2 polarized	RB121PG-5VDC	1SNA645036R2500	10	0.02 (0.044)
12 V DC	screw		RB121G-12VDC	1SNA645075R0000		
24 V DC	screw		RB121G-24VDC	1SNA645072R0000		
24 V AC/DC	screw		RB121G-24VUC	1SNA645005R0700		
48-60 V AC/DC	screw		RB121G-48-60VUC	1SNA645006R0000		
115 V AC/DC	screw		RB121G-115VUC	1SNA645007R0100		
230 V AC/DC	screw		RB121G-230VUC	1SNA645008R1200		
24 V DC	spring		RBR121G-24VDC	1SNA645572R0000		
24 V AC/DC	spring		RBR121G-24VUC	1SNA645505R0100		
48-60 V AC/DC	spring		RBR121G-48-60VUC	1SNA645506R0200		
115 V AC/DC	spring		RBR121G-115VUC	1SNA645507R0300		
230 V AC/DC	spring		RBR121G-230VUC	1SNA645508R1400		

Ordering details - 1 c/o (SPDT) contact: 250 V AC, 10 mA - 6 A, width 12 mm

Rated control supply voltage	Connection type	Particularities	Type	Order code	Pkg qty	Weight (1 pc.) kg (lb)
60-230 V AC/DC	screw		RB121-60-230VUC	1SNA645020R0100	5	0.04 (0.088)
115 V AC/DC	screw	Leakage current protection, RC circuit parallel to input	RB121R-115VUC	1SNA645046R0700		
230 V AC/DC	screw		RB121R-230VUC	1SNA645011R2400		
60-230 V AC/DC	spring		RBR121-60-230VUC	1SNA645520R0300	5	0.04 (0.088)
230 V AC/DC	spring	Leakage current protection, RC circuit parallel to input	RBR121R-230VUC	1SNA645511R2600		



R600 - 12 mm

2CDC29H 013 50013

Ordering details - 2 c/o (SPDT) contacts: 250 V AC, 1 mA - 8 A, gold-plated contacts, width 12 mm

Rated control supply voltage	Connection type	Type	Order code	Pkg qty	Weight (1 pc.) kg (lb)
24 V AC/DC	screw	RB122G-24VUC	1SNA645012R2500	5	0.04 (0.088)
48-60 V AC/DC	screw	RB122G-48-60VUC	1SNA645040R1500		
115 V AC/DC	screw	RB122G-115VUC	1SNA645041R0200		
230 V AC/DC	screw	RB122G-230VUC	1SNA645013R2600		
24 V AC/DC	spring	RBR122G-24VUC	1SNA645512R2700		
48-60 V AC/DC	spring	RBR122G-48-60VUC	1SNA645540R1700		
115 V AC/DC	spring	RBR122G-115VUC	1SNA645541R0400		
230 V AC/DC	spring	RBR122G-230VUC	1SNA645513R2000		

Ordering details - Accessories



Description	Type	Order code	Pkg qty	Weight (1 pc.) kg (lb)
Jumper bar, 10 poles * (replacement of BJ612-10 - 1SNA290488R0100)	RB-JB10	1SVR406570R0000	10	0.05 (0.11)
Jumper bar, 20 poles * (replacement of BJ612-20 - 1SNA206754R0000)	RB-JB20	1SVR406580R0000		0.10 (0.22)
Separator end section	SC612	1SNA290474R0200		0.05 (0.11)

* - Before the first and after the last jumpered R600 relay, a separator end section shall be used.

- The sum of the current for jumpered devices shall not exceed 6 A on 6 mm devices and 8 A on 12 mm devices.

Boxed interface relays R600 range

Technical data

		RB(R)101R-		RB(R)111R-	
		24 V UC		24 V UC	
Input circuit					
Rated control supply voltage U_s		24 V AC/DC			
Rated control supply voltage U_s tolerance	DC	-15 %, +20 %			
	AC	-/+ 10 %			
Rated frequency		50/60 Hz			
Typical power consumption		0.24 W			
Typical current		10 mA			
Drop-out voltage	at 20 °C	4.5 V			
Indication of operational states	green LED	 : control supply voltage applied			
Output circuit					
Kind of output	11-12	relay, 1 n/c contact		-	
	13-14	-		relay, 1 n/o contact	
Rated operational voltage U_e		250 V AC			
Minimum switching voltage		5 V			
Maximum switching voltage		250 V AC			
Minimum switching current		60 mA			
Rated free air thermal current I_{th}		6 A			
Rated operational current I_e	AC-12 (resistive) 230 V	6 A			
	AC-15 (inductive) 230 V	1.5 A			
	AC-15 (inductive) 120 V	3 A			
	DC-12 (resistive) 24 V	6 A			
	DC-13 (inductive) 24 V	1 A			
	DC-13 (inductive) 110 V	0.2 A			
	DC-13 (inductive) 220 V	0.1 A			
AC rating (UL 508; NEMA ICS-5)	utilization category (pilot duty)	B300			
DC rating (UL 508; NEMA ICS-5)	utilization category (pilot duty)	R300			
Minimum switching power		300 mW			
Mechanical lifetime		1 x 10 ⁷ switching cycles			
Electrical lifetime	at AC-15	1 x 10 ⁵ switching cycles			
Max. fuse rating to achieve short-circuit protection		6 A fast			
Response time		5 ms			
Release time		8 ms			
RB(R)111-					
		24 V UC		115 V UC	
				230 V UC	
Input circuit					
Rated control supply voltage U_s		24 V AC/DC	115 V AC/DC	230 V AC/DC	
Rated control supply voltage U_s tolerance	DC	-15 %, +20 %		-15 %, +10 %	
	AC	-/+ 10 %			
Rated frequency		50/60 Hz			
Typical power consumption		0.24 W	0.46 W	0.8 W	
Typical current		10 mA	4 mA	3.5 mA	
Drop-out voltage	at 20 °C	4.5 V	17 V	27 V	
Indication of operational states	green LED	 : control supply voltage applied			
Output circuit					
Kind of output	13-14	relay, 1 n/o contact			
Rated operational voltage U_e		250 V AC			
Minimum switching voltage		12 V			
Maximum switching voltage		250 V AC			
Minimum switching current		10 mA			
Rated free air thermal current I_{th}		6 A			

Boxed interface relays R600 range

Technical data

		RB(R)111-		
		24 V UC	115 V UC	230 V UC
Rated operational current I_e	AC-12 (resistive) 230 V	6 A		
	AC-15 (inductive) 230 V	1.5 A		
	AC-15 (inductive) 120 V	3 A		
	DC-12 (resistive) 24 V	6 A		
	DC-13 (inductive) 24 V	1 A		
	DC-13 (inductive) 110 V	0.2 A		
	DC-13 (inductive) 220 V	0.1 A		
AC rating (UL 508; NEMA ICS-5)	utilization category (pilot duty)	B300		
DC rating (UL 508; NEMA ICS-5)	utilization category (pilot duty)	R300		
Minimum switching power		300 mW		
Mechanical lifetime		1 x 10 ⁷ switching cycles		
Electrical lifetime		at AC-15 1 x 10 ⁵ switching cycles		
Max. fuse rating to achieve short-circuit protection		6 A fast		
Response time		5 ms	6 ms	7 ms
Release time		8 ms	15 ms	15 ms

		RB(R)121(P)(G)-							
		5 V DC	12 V DC	24 V DC	24 V UC	48-60 V UC	115 V UC	230 V UC	
Input circuit									
Rated control supply voltage U_s		5 V DC	12 V DC	24 V DC	24 V AC/DC	48 V AC/DC	60 V AC/DC	115 V AC/DC	230 V AC/DC
Rated control supply voltage		DC -15 %, +20 %							-15 %, +10 %
U_s tolerance		AC -			-/+ 10 %				
Rated frequency		-			50/60 Hz				
Typical power consumption		0.2 W	0.2 W	0.24 W		0.33 W	0.54 W	0.46 W	0.8 W
Typical current		40 mA	16 mA	10 mA		7 mA	9 mA	4 mA	3.5 mA
Drop-out voltage		at 20 °C 1.2 V 2.2 V 4.5 V			8 V	8 V	17 V	27 V	
Indication of operational states		green LED control supply voltage applied							
Output circuit									
Kind of output		11-12/14 relay, 1 c/o (SPDT) contact							
Rated operational voltage U_e		250 V AC							
Minimum switching voltage		5 V / gold-plated contacts: 5 V							
Maximum switching voltage		250 V AC							
Minimum switching current		60 mA / gold-plated contacts: 10 mA							
Rated free air thermal current I_{th}		6 A							
Rated operational current I_e	AC-12 (resistive) 230 V	6 A							
	AC-15 (inductive) 230 V	1.5 A							
	AC-15 (inductive) 120 V	3 A							
	DC-12 (resistive) 24 V	6 A							
	DC-13 (inductive) 24 V	1 A							
	DC-13 (inductive) 110 V	0.2 A							
	DC-13 (inductive) 220 V	0.1 A							
AC rating (UL 508; NEMA ICS-5)	utilization category (pilot duty)	B300							
DC rating (UL 508; NEMA ICS-5)	utilization category (pilot duty)	R300							
Minimum switching power		300 mW / gold-plated contacts: 50 mW							
Mechanical lifetime		1 x 10 ⁷ switching cycles							
Electrical lifetime		at AC-15 1 x 10 ⁵ switching cycles							
Max. fuse rating to achieve short-circuit protection		6 A fast							
Response time		5 ms	5 ms	5 ms		5 ms	5 ms	6 ms	7 ms
Release time		8 ms	8 ms	8 ms		8 ms	8 ms	15 ms	16 ms

Boxed interface relays R600 range

Technical data

		RB(R)121R-	
		115 V UC	230 V UC
Input circuit			
Rated control supply voltage U_s		115 V AC/DC	230 V AC/DC
Rated control supply voltage U_s tolerance	DC	-20%, +15%	-10%, +15%
	AC	-/+ 10 %	
Rated frequency		50/60 Hz	
Typical power consumption		2 W	2.8 W
Typical current		18 mA	12 mA
Drop-out voltage	at 20 °C	17 V	27 V
Indication of operational states	green LED	: control supply voltage applied	
Output circuit			
Kind of output	11-12/14	relay, 1 c/o (SPDT) contact	
Rated operational voltage U_e		250 V AC	
Minimum switching voltage		5 V	
Maximum switching voltage		250 V AC	
Minimum switching current		60 mA	
Rated free air thermal current I_{th}		6 A	
Rated operational current I_e	AC-12 (resistive) 230 V	6 A	
	AC-15 (inductive) 230 V	1.5 A	
	AC-15 (inductive) 120 V	3 A	
	DC-12 (resistive) 24 V	6 A	
	DC-13 (inductive) 24 V	1 A	
	DC-13 (inductive) 110 V	0.2 A	
	DC-13 (inductive) 220 V	0.1 A	
AC rating (UL 508; NEMA ICS-5)	utilization category (pilot duty)	B300	
DC rating (UL 508; NEMA ICS-5)	utilization category (pilot duty)	R300	
Minimum switching power		300 mW	
Mechanical lifetime		1 x 10 ⁷ switching cycles	
Electrical lifetime	at AC-15	1 x 10 ⁵ switching cycles	
Max. fuse rating to achieve short-circuit protection		6 A fast	
Response time		6 ms	7 ms
Release time		15 ms	16 ms

Boxed interface relays R600 range

Technical data

		RB(R)122G				
		24 V UC	48-60 V UC		115 V UC	230 V UC
Input circuit						
Rated control supply voltage U_s		24 V AC/DC	48 V AC/DC	60 V AC/DC	115 V AC/DC	230 V AC/DC
Rated control supply voltage U_s tolerance	DC	-15 %, +20 %				-15 %, +10 %
	AC	-/+ 10 %				
Rated frequency		50/60 Hz				
Typical power consumption		0.48 W	0.62 W	0.96 W	0.58 W	1.15 W
Typical current		20 mA	13 mA	16 mA	5 mA	5 mA
Drop-out	at 20 °C	5.4 V	8.8 V	8.8 V V	20 V	10 V
Indication of operational states	green LED	□: control supply voltage applied				
Output circuit						
Kind of output	11-12/14	relay, 1st c/o (SPDT) contact				
	21-22/24	relay, 2nd c/o (SPDT) contact				
Rated operational voltage U_e		250 V				
Minimum switching voltage		5 V / gold-plated contacts: 5 V				
Maximum switching voltage		250 V				
Minimum switching current		60 mA / gold-plated contacts: 10 mA				
Rated free air thermal current I_{th}		8 A				
Rated operational current I_e	AC-12 (resistive) 230 V	8 A				
	AC-15 (inductive) 230 V	1.5 A				
	DC-12 (resistive) 24 V	8 A				
	DC-13 (inductive) 24 V	1 A				
	DC-13 (inductive) 110 V	0.2 A				
	DC-13 (inductive) 220 V	0.1 A				
Minimum switching power		300 mW / gold-plated contacts: 50 mW				
Mechanical lifetime		2 x 10 ⁷ switching cycles				
Electrical lifetime	at AC-15	1 x 10 ⁵ switching cycles				
Max. fuse rating to achieve short-circuit protection		10 A fast				
Response time		6 ms	10 ms	10 ms	6 ms	6 ms
Release time		10 ms	14 ms	14 ms	15 ms	15 ms

General technical data - Interface relays

		RB	RBR
General data			
Material of housing		UL 94 V0	
Mounting		DIN rail	
Degree of protection	housing / terminals	IP20 NEMA1	
Electrical connection			
Connecting capacity	fine-strand	0.22-2.5 mm ² (24-14 AWG)	
	rigid	0.2-4 mm ² (24-12 AWG)	0.2-2.5 mm ² (24-14 AWG)
Stripping length		9 mm (0.354 in)	
Tightening torque		0.4-0.6 Nm (3.5-5.3 lb.in)	n/a
Environmental data			
Ambient temperature ranges	storage	-40...+80 °C (-40...+176 °F)	
	operation	-20...+70 °C (-4...+158 °F) ¹⁾	
Isolation data			
Rated insulation voltage U_i		250 V	
Rated impulse withstand voltage U_{imp}	input / output	4 kV (1.2/50 μs)	
	shock coil / output	4 kV (1.2/50 μs)	
	output / output	1 kV (1.2/50 μs)	
Overvoltage category		III	
Pollution degree		2	
Standards/Directives			
Standards		IEC/EN 60947-5-1	
Low Voltage Directive		2014/35/EC	
RoHS Directive		2011/65/EC	

¹⁾ Over 55 °C, blocks have to be mounted on horizontal rail with 10 mm spacing between each block. For vertical rail mounting max. operation temperature is 15 °C lower.

Boxed interface relays R600 range

Technical diagrams

Load limit curves

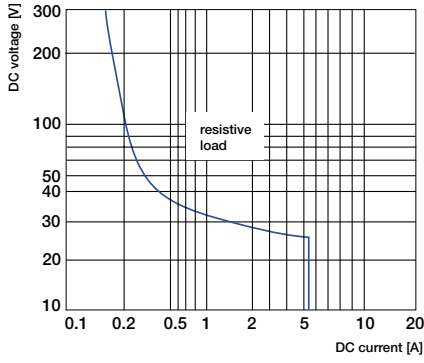

2CDC2920028F0212

Versions with 1 n/o, 1 n/c or 1 c/o contact

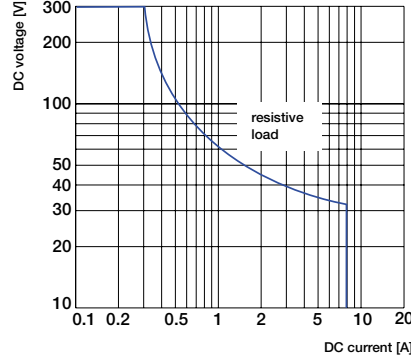

2CDC292028F0213

Versions with 2 c/o contacts

Dimensional drawings in mm and inches

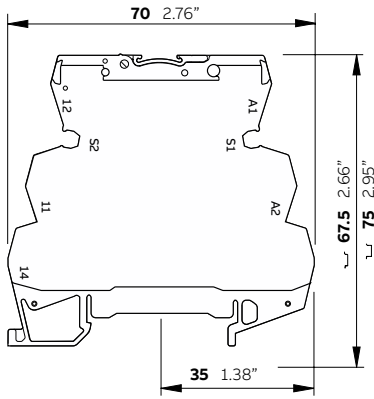

2CDC292028F0013

R600 - screw connection

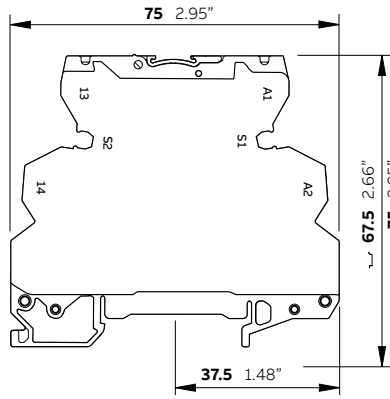

2CDC292028F0013

R600 - spring connection

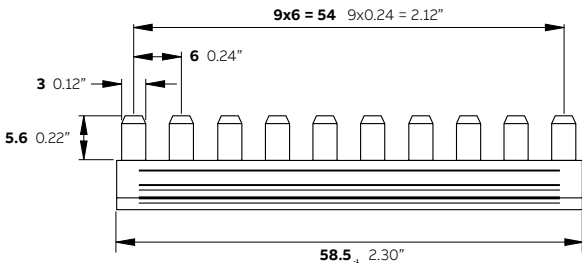

RB-JB10

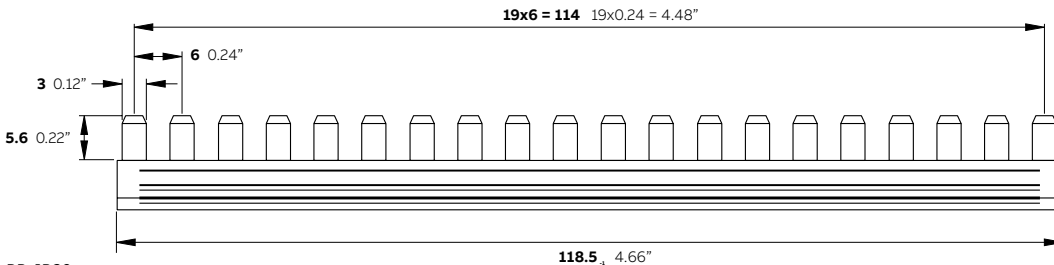
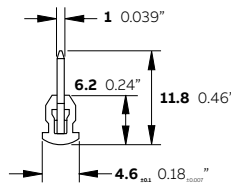

RB-JB20

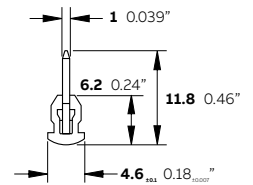

Boxed interface relays R600 range

Technical diagrams

Connection diagrams

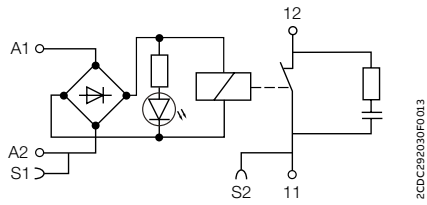

RB(R)101R-24VUC

2CDC292030F0013

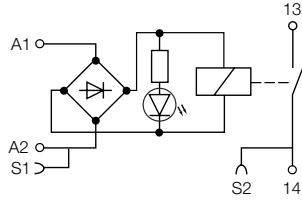

RB(R)111-24VUC

2CDC292031F0013

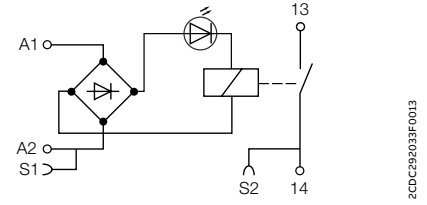

RB111-115VUC/230VUC

2CDC292033F0013

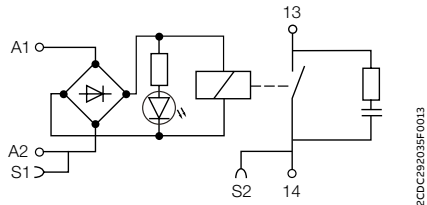

RB(R)111R-24VUC

2CDC292035F0013

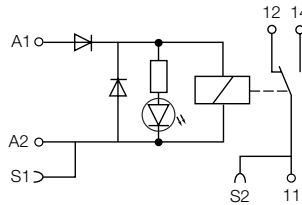

RB(R)121P(G)-5VDC/12VDC

2CDC292036F0013

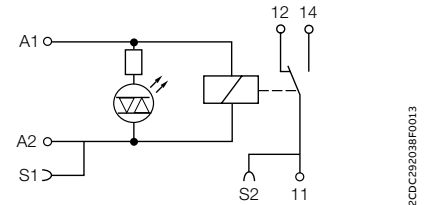

RB(R)121-12VDC/24VDC

2CDC292038F0013

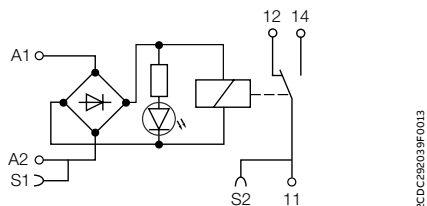

RB(R)121(G)-24VUC

2CDC292039F0013

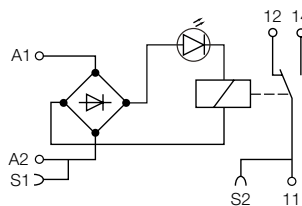

RB(R)121(G)-48-60VUC/
115VUC/230VUC/60-230VUC

2CDC292040F0013

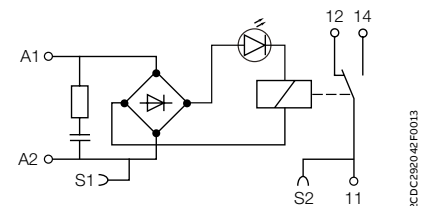

RB(R)121R-115VUC/230VUC

2CDC292042F0013

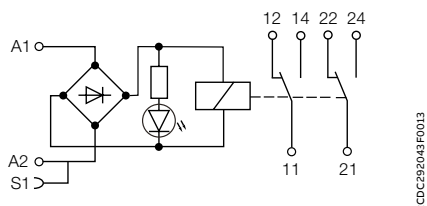

RB(R)122G-24VUC/48-60VUC

2CDC292043F0013

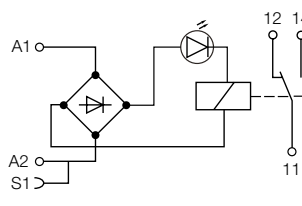

RB(R)122G-115VUC/230VUC

2CDC292044F0013

Boxed optocouplers R600 range

Ordering details



R600 - 6 mm

Ordering details - Transistor output, 58 V DC, 100 mA, width 6 mm

Rated control supply voltage	Connection type	Type	Order code	Pkg qty	Weight (1 pc.) kg (lb)
5 - 12 V DC	screw	OBIC0100-5-12VDC	1SNA645047R0000	10	0.02 (0.044)
24 V DC	screw	OBIC0100-24VDC	1SNA645021R2600		
48 - 60 V AC/DC	screw	OBIC0100-48-60VUC	1SNA645049R1200		
115 - 230 V AC/DC	screw	OBIC0100-115-230	1SNA645022R2700		
5 - 12 V DC	spring	OBRIC0100-5-12VDC	1SNA645547R0200	10	0.02 (0.044)
24 V DC	spring	OBRIC0100-24VDC	1SNA645521R2000		
48 - 60 V AC/DC	spring	OBRIC0100-48-60VUC	1SNA645549R1400		
115 - 230 V AC/DC	spring	OBRIC0100-115-230	1SNA645522R2100		

Ordering details - MOS-FET output, 58 V DC, 2 A, width 6 mm

Rated control supply voltage	Connection type	Type	Order code	Pkg qty	Weight (1 pc.) kg (lb)
5 - 12 V DC	screw	OBOC2000-5-12VDC	1SNA645050R1700	10	0.02 (0.044)
24 V DC	screw	OBOC2000-24VDC	1SNA645051R0400		
24 V AC/DC	screw	OBOC2000-24VUC	1SNA645025R2200		
48 - 60 V AC/DC	screw	OBOC2000-48-60VUC	1SNA645053R0600		
115 V AC/DC	screw	OBOC2000-115VUC	1SNA645054R0700		
230 V AC/DC	screw	OBOC2000-230VUC	1SNA645026R2300	10	0.02 (0.044)
5 - 12 V DC	spring	OBROC2000-5-12VDC	1SNA645550R1100		
24 V DC	spring	OBROC2000-24VDC	1SNA645551R0600		
24 V AC/DC	spring	OBROC2000-24VUC	1SNA645525R2400		
48 - 60 V AC/DC	spring	OBROC2000-48-60VUC	1SNA645553R0000		
230 V AC/DC	spring	OBROC2000-230VUC	1SNA645526R2500		

Ordering details - MOS-FET output, 58 V DC, 5 A, width 6 mm

Rated control supply voltage	Connection type	Type	Order code	Pkg qty	Weight (1 pc.) kg (lb)
24 V DC	screw	OBOC5000-24VDC	1SNA645024R2100	10	0.02 (0.044)
115 V AC/DC	screw	OBOC5000-115VUC	1SNA645058R1300		
24 V DC	spring	OBROC5000-24VDC	1SNA645524R2300	10	0.02 (0.044)
230 V AC/DC	spring	OBROC5000-230VUC	1SNA645559R1600		

Ordering details - Triac output, 400 V AC, 1 A, width 6 mm

Rated control supply voltage	Connection type	Type	Order code	Pkg qty	Weight (1 pc.) kg (lb)
24 V DC	screw	OBOA1000-24VDC	1SNA645027R2400	10	0.03 (0.066)
115 V AC/DC	screw	OBOA1000-115VUC	1SNA645062R0700		
230 V AC/DC	screw	OBOA1000-230VUC	1SNA645028R0500		
24 V DC	spring	OBROA1000-24VDC	1SNA645527R2600	10	

Boxed optocouplers R600 range

Ordering details



R600 - 12 mm

2CDC291 013 S0013

Ordering details - Triac output, 230 V AC, 2 A, width 12 mm

Rated control supply voltage	Connection type	Type	Order code	Pkg qty	Weight (1 pc.) kg (lb)
24 V DC	screw	OBOA2000-24VDC	1SNA645029R0600	5	0.03
24 V DC	spring	OBROA2000-24VDC	1SNA645529R0000	5	(0.066)

Ordering details - Accessories

Description	Type	Order code	Pkg qty	Weight (1 pc.) kg (lb)
Jumper bar, 10 poles * (replacement of BJ612-10 - 1SNA290488R0100)	RB-JB10	1SVR406570R0000	10	0.05 (0.11)
Jumper bar, 20 poles * (replacement of BJ612-20 - 1SNA206754R0000)	RB-JB20	1SVR406580R0000		0.10 (0.22)
Separator end section	SC612	1SNA290474R0200		0.05 (0.11)

* - Before the first and after the last jumpered R600 optocoupler, a separator end section shall be used.
 - The sum of the current for jumpered devices shall not exceed 6 A on 6 mm devices and 8 A on 12 mm devices.

Boxed optocouplers R600 range

Technical data

	OB(R)IC0100-...						
	5-12 V DC		24 V DC	48-60 V UC		115-230	
Input circuit							
Control voltage	5 V DC	12 V DC	24 V DC	48 V AC/DC	60 V AC/DC	115 V AC/DC	230 V AC/DC
Frequency	-			50/60 Hz			
Input current	5 mA	9 mA	4 mA	4 mA	5 mA	7 mA (AC) 16 mA (DC)	11.5 mA (AC) 25 mA (DC)
Pull-in voltage	4 V		15 V	25 V		60 V AC / 70 V DC	
Typ. switch-on time	10 µs			5 ms			
Typ. switch-off time	500 µs			20 ms			
Operating frequency	1000 Hz				20 Hz		
Permissible leakage current	0.9 mA		1.0 mA	0.9 mA		1.6 mA	
Output circuit							
	11(13+)- 14						
Kind of output	Transistor						
Rated operational voltage	4.5-58 V DC						
Minimum switching current	1 mA						
Maximum switching current	100 mA						
Leakage current at max. switching voltage	< 50 µA						
Rated operational current I_e (IEC/EN 60947-5-1)	DC-12 (resistive) 58 V		0.1 A				
Residual voltage	typical		1 V				
	maximum		1.3 V				
Max. fuse rating to achieve short-circuit protection	100 mA fast						
Isolation data							
Rated insulation voltage U_i	250 V						
Rated impulse withstand voltage U_{imp}	2.5 kV (1.2/50 µs)						
Overvoltage category	II						
Pollution degree	2						

	OB(R)OC2000-...							
	5-12 V DC		24 V DC	24 V UC	48-60 V UC		115 V UC	230 V UC
Input circuit								
Control voltage	5 V DC	12 V DC	24 V DC	24 V AC/DC	48 V AC/DC	60 V AC/DC	115 V AC/DC	230 V AC/DC
Frequency	-			50/60 Hz				
Input current	5 mA	9 mA	5.4 mA	6.3 mA	4 mA	5.1 mA	4.2 mA	4 mA
Pull-in voltage	4 V		12 V	15 V	27 V		50 V	80 V
Typ. switch-on time	15 µs		30 µs	1 ms	5 ms		500 µs	1 ms
Typ. switch-off time	250 µs		400 µs	7 ms	20 ms		10 ms	15 ms
Operating frequency	2000 Hz		1000 Hz	60 Hz	20 Hz		50 Hz	35 Hz
Permissible leakage current	1 mA		0.8 mA	0.9 mA	1 mA		0.3 mA	
Output circuit								
	11(13+)- 14							
Kind of output	MOS-FET							
Rated operational voltage	4.5-58 V DC							
Minimum switching current	1 mA							
Maximum switching current	2 A							
Leakage current at max. switching voltage	< 50 µA							
Rated operational current I_e (IEC/EN 60947-5-1)	DC-12 (resistive) 58 V		2 A					
Residual voltage	typical		0.1 V					
	maximum		0.5 V					
Max. fuse rating to achieve short-circuit protection	2 A ultra-fast							
Isolation data								
Rated insulation voltage U_i	250 V							
Rated impulse withstand voltage U_{imp}	2.5 kV (1.2/50 µs)							
Overvoltage category	II							
Pollution degree	2							

Boxed optocouplers R600 range

Technical data

		OB(R)OC5000-...		
		24 V DC	115 V UC	230 V UC
Input circuit				
Control voltage		24 V DC	115 V AC/DC	230 V AC/DC
Frequency		-	50/60 Hz	
Input current		5.4 mA	4.2 mA	4 mA
Pull-in voltage		12 V	50 V	80 V
Typ. switch-on time		30 μ s	500 μ s	1 ms
Typ. switch-off time		400 μ s	10 ms	15 ms
Operating frequency		1000 Hz	50 Hz	35 Hz
Permissible leakage current		0.8 mA	0.3 mA	0.3 mA
Output circuit		11(13+)- 14		
Kind of output		MOS-FET		
Rated operational voltage		4.5-58 V DC		
Minimum switching current		1 mA		
Maximum switching current		5 A		
Leakage current at max. switching voltage		< 50 μ A		
Rated operational current I_e	DC-12 (resistive) 58 V	5 A		
Residual voltage	typical	0.1 V		
	maximum	0.5 V		
Max. fuse rating to achieve short-circuit protection		6 A ultra-fast		
Isolation data				
Rated insulation voltage U_i		250 V		
Rated impulse withstand voltage U_{imp}		2.5 kV (1.2/50 μ s)		
Overvoltage category		II		
Pollution degree		2		

		OB(R)OA1000-...			OB(R)OA2000-...
		24 V DC	115 V UC	230 V UC	24 V DC
Input circuit					
Control voltage		24 V DC	115 V AC/DC	230 V AC/DC	24 V DC
Frequency		-	50/60 Hz		-
Input current		3.6 mA	4.15 mA	4.6 mA	3.6 mA
Pull-in voltage		14 V	60 V	135 V	14 V
Typ. switch-on time		150 μ s	2.2 ms	2.5 ms	150 μ s
Typ. switch-off time		1 ms	18 ms	25 ms	1 ms
Operating frequency		500 Hz	25 Hz	20 Hz	500 Hz
Permissible leakage current		1 mA			1 mA
Output circuit		11(13+)- 14			
Kind of output		Triac			Triac
Rated operational voltage		24-400 V AC			10-230 V AC
Minimum switching current		25 mA			25 mA
Maximum switching current		1 A			2 A
Leakage current at max. switching voltage		< 500 μ A			< 500 μ A
Rated operational current I_e	AC-12 (resistive) 400 V	1 A			-
	AC-12 (resistive) 230 V	-			2A
Residual voltage	typical	1 V			1 V
	maximum	1.6 V			1.6 V
Max. fuse rating to achieve short-circuit protection		4 A ultra-fast			4 A ultra-fast
Isolation data					
Rated insulation voltage U_i		400 V			230 V
Rated impulse withstand voltage U_{imp}		4 kV (1.2/50 μ s)			4 kV (1.2/50 μ s)
Overvoltage category		II			II
Pollution degree		2			2

Boxed optocouplers R600 range

Technical data

General technical data - Optocouplers

		OB	OBR
General data			
Material of housing		UL 94 V0	
Mounting		DIN Rail	
Degree of protection	housing / terminals	IP20 NEMA1	
Electrical connection		Screw terminal	Spring-type terminal
Connecting capacity	fine-strand	0.22-2.5 mm ² (24-14 AWG)	
	rigid	0.2-4 mm ² (24-12 AWG)	0.2-2.5 mm ² (24-14 AWG)
Stripping length		9 mm (0.354 in)	
Tightening torque		0.4-0.6 Nm (3.5-5.3 lb.in)	n/a
Environmental data			
Ambient temperature ranges	storage	-40...+80 °C (-40...+176 °F)	
	operation	-20...+70 °C (-4...+158 °F)	
Standards/Directives			
Standards		IEC/EN 60947-5-1	
Low Voltage Directive		2014/35/EU	
RoHS Directive		2011/65/EU	

Boxed optocouplers R600 range

Technical diagrams

Dimensional drawings in mm and inches

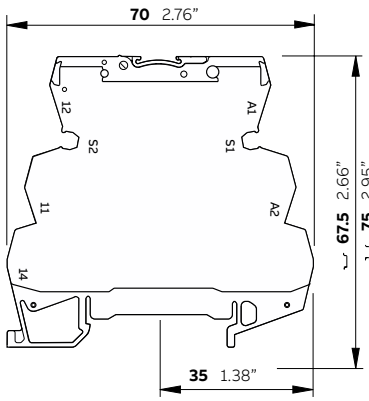

R600 - screw connection

2CDC29025F0013

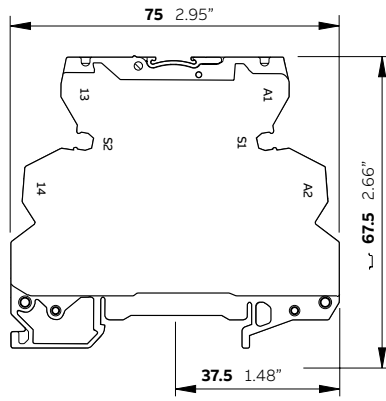

R600 - spring connection

2CDC29026F0013

Connection diagrams

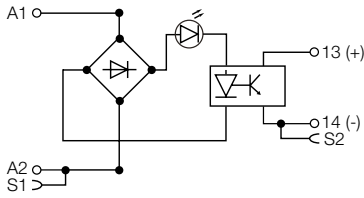

OB(R)OC, OB(R)IC
except 5-12 V DC versions

2CDC292019F0016

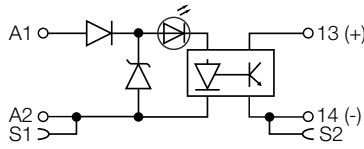

OB(R)IC0100-5-12 V DC
OB(R)OC2000-5-12 V DC

2CDC292017F0016

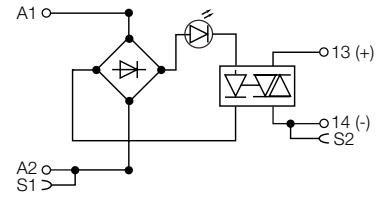

OB(R)OA

2CDC292018F0016



Index

Index

Time relays Product type

Type	Order code	Page	Type	Order code	Page
ADP.01	1SVR430029R0100	41	CT-TGC.12	1SVR508160R0000	25
COV.11	1SVR730005R0100	41	CT-TGC.22	1SVR508160R0100	25
CT-MXS.22S	1SVR730030R3300	39	CT-TGD.12	1SVR500160R0000	56
CT-AHC.12	1SVR508110R0000	25	CT-TGD.22	1SVR500160R0100	56
CT-AHC.22	1SVR508110R0100	25	CT-VWC.12	1SVR508250R0000	25
CT-AHD.12	1SVR500110R0000	57	CT-VWD.12	1SVR500250R0000	56
CT-AHD.22	1SVR500110R0100	57	CT-WBS.22P	1SVR740040R3300	39
CT-AHS.22P	1SVR740110R3300	40	CT-WBS.22S	1SVR730040R3300	39
CT-AHS.22S	1SVR730110R3300	40	KA1-8029	1SFA616920R8029	41
CT-APS.12P	1SVR740180R3100	40	KA1-8030	1SFA616920R8030	41
CT-APS.12S	1SVR730180R3100	40	MA16-1060	1SFA611940R1060	41
CT-APS.21P	1SVR740180R0300	40	MAR.01	1SVR366017R0100	41
CT-APS.21S	1SVR730180R0300	40	MAR.12	1SVR730006R0000	41
CT-APS.22P	1SVR740180R3300	40	MT-150B	1SFA611410R1506	41
CT-APS.22S	1SVR730180R3300	40	MT-250B	1SFA611410R2506	41
CT-ARC.12	1SVR508120R0000	25	MT-350B	1SFA611410R3506	41
CT-ARS.11P	1SVR740120R3100	40	SK 615 562-87	GJD6155620R0087	41
CT-ARS.11S	1SVR730120R3100	40	SK 615 562-88	GJD6155620R0088	41
CT-ARS.21P	1SVR740120R3300	40			
CT-ARS.21S	1SVR730120R3300	40			
CT-EBC.12	1SVR508150R0000	25			
CT-EBD.12	1SVR500150R0000	56			
CT-ERC.12	1SVR508100R0000	25			
CT-ERC.22	1SVR508100R0100	25			
CT-ERD.12	1SVR500100R0000	56			
CT-ERD.22	1SVR500100R0100	56			
CT-ERS.12P	1SVR740100R3100	40			
CT-ERS.12S	1SVR730100R3100	40			
CT-ERS.21P	1SVR740100R0300	40			
CT-ERS.21S	1SVR730100R0300	40			
CT-ERS.22P	1SVR740100R3300	40			
CT-ERS.22S	1SVR730100R3300	40			
CT-MBS.22P	1SVR740010R3200	39			
CT-MBS.22S	1SVR730010R3200	39			
CT-MFC.12	1SVR508020R0000	25			
CT-MFC.21	1SVR508020R1100	25			
CT-MFD.12	1SVR500020R0000	56			
CT-MFD.21	1SVR500020R1100	56			
CT-MFS.21P	1SVR740010R0200	39			
CT-MFS.21S	1SVR730010R0200	39			
CT-MVS.23S	1SVR730021R2300	39			
CT-MXS.22P	1SVR740030R3300	39			
CT-SAC.22	1SVR508210R0100	25			
CT-SAD.22	1SVR500210R0100	56			
CT-SDC.22	1SVR508211R0100	25			
CT-SDD.22	1SVR500211R0100	56			
CT-SDS.22P	1SVR740210R3300	40			
CT-SDS.22S	1SVR730210R3300	40			
CT-SDS.23P	1SVR740211R2300	40			
CT-SDS.23S	1SVR730211R2300	40			

Index

Time relays

Order code

Order code	Type	Page
1SFA611410R1506	MT-150B	29
1SFA611410R2506	MT-250B	29
1SFA611410R3506	MT-350B	29
1SFA611940R1060	MA16-1060	29
1SFA616920R8029	KA1-8029	29
1SFA616920R8030	KA1-8030	29
1SVR366017R0100	MAR.01	29
1SVR430029R0100	ADP.01	41
1SVR500020R0000	CT-MFD.12	56
1SVR500020R1100	CT-MFD.21	56
1SVR500100R0000	CT-ERD.12	56
1SVR500100R0100	CT-ERD.22	56
1SVR500110R0000	CT-AHD.12	56
1SVR500110R0100	CT-AHD.22	56
1SVR500250R0000	CT-VWD.12	56
1SVR500150R0000	CT-EBD.12	56
1SVR500160R0000	CT-TGD.12	56
1SVR500160R0100	CT-TGD.22	56
1SVR500210R0100	CT-SAD.22	56
1SVR500211R0100	CT-SDD.22	56
1SVR508020R0000	CT-MFC.12	25
1SVR508100R0000	CT-ERC.12	25
1SVR508100R0100	CT-ERC.22	25
1SVR508110R0000	CT-AHC.12	25
1SVR508110R0100	CT-AHC.22	25
1SVR508120R0000	CT-ARC.12	25
1SVR508250R0000	CT-VWC.12	25
1SVR508150R0000	CT-EBC.12	25
1SVR508160R0000	CT-TGC.12	25
1SVR508160R0100	CT-TGC.22	25
1SVR508180R0100	CT-PAC.22	25
1SVR508210R0100	CT-SAC.22	25
1SVR508211R0100	CT-SDC.22	25
1SVR730005R0100	COV.11	29
1SVR730006R0000	MAR.12	29
1SVR730010R0200	CT-MFS.21S	39
1SVR730010R3200	CT-MBS.22S	39
1SVR730021R2300	CT-MVS.23S	39
1SVR730030R3300	CT-MXS.22S	39
1SVR730040R3300	CT-WBS.22S	39
1SVR730100R0300	CT-ERS.21S	40
1SVR730100R3100	CT-ERS.12S	40
1SVR730100R3300	CT-ERS.22S	40
1SVR730110R3300	CT-AHS.22S	40
1SVR730120R3100	CT-ARS.11S	40
1SVR730120R3300	CT-ARS.21S	40
1SVR730180R0300	CT-APS.21S	40
1SVR730180R3100	CT-APS.12S	40
1SVR730180R3300	CT-APS.22S	40
1SVR730210R3300	CT-SDS.22S	40

Order code	Type	Page
1SVR730211R2300	CT-SDS.23S	40
1SVR740010R0200	CT-MFS.21P	39
1SVR740010R3200	CT-MBS.22P	39
1SVR740030R3300	CT-MXS.22P	39
1SVR740040R3300	CT-WBS.22P	39
1SVR740100R0300	CT-ERS.21P	40
1SVR740100R3100	CT-ERS.12P	40
1SVR740100R3300	CT-ERS.22P	40
1SVR740110R3300	CT-AHS.22P	40
1SVR740120R3100	CT-ARS.11P	40
1SVR740120R3300	CT-ARS.21P	40
1SVR740180R0300	CT-APS.21P	40
1SVR740180R3100	CT-APS.12P	40
1SVR740180R3300	CT-APS.22P	40
1SVR740210R3300	CT-SDS.22P	40
1SVR740211R2300	CT-SDS.23P	40
GJD6155620R0087	SK 615 562-87	41
GJD6155620R0088	SK 615 562-88	41

Index

Measuring and monitoring relays Product type

Type	Order code	Page	Type	Order code	Page
ADP.01	1SVR430029R0100	262	CM-ENS.31S	1SVR730850R0300	249
ADP.02	1SVR440029R0100	262	CM-ESS.1P	1SVR740830R0300	89
C011-100	GHC0110003R0004	191	CM-ESS.1P	1SVR740831R0300	89
C011-110	GHC0110003R0005	191	CM-ESS.1P	1SVR740831R1300	89
C011-189	GHC0110003R0006	191	CM-ESS.1S	1SVR730830R0300	89
C011-130	GHC0110003R0007	191	CM-ESS.1S	1SVR730831R0300	89
C011-140	GHC0110003R0011	191	CM-ESS.1S	1SVR730831R1300	89
C011-150	GHC0110003R0008	191	CM-ESS.2P	1SVR740830R0400	89
C011-160	GHC0110003R0009	191	CM-ESS.2P	1SVR740831R0400	89
C011-860	GHC0110003R0010	191	CM-ESS.2P	1SVR740831R1400	89
C011-3-150	GHC0110033R0008	191	CM-ESS.2S	1SVR730830R0400	89
C011-70	GHC0110003R0001	191	CM-ESS.2S	1SVR730831R0400	89
C011-80	GHC0110003R0002	191	CM-ESS.2S	1SVR730831R1400	89
C011-90	GHC0110003R0003	191	CM-ESS.MP	1SVR740830R0500	89
CM-AH-3	1SVR450056R7000	262	CM-ESS.MS	1SVR730830R0500	89
CM-CT 100/1	1SVR450116R1890	263	CM-GM-1	1SVR450056R8000	262
CM-CT 100/5	1SVR450116R5200	263	CM-HC	1SVR402902R1000	262
CM-CT 150/1	1SVR450116R1300	263	CM-HCT	1SVR402902R2000	262
CM-CT 150/5	1SVR450116R5300	263	CM-HE	1SVR402902R0000	262
CM-CT 200/1	1SVR450116R1400	263	CM-IVN.P	1SVR760669R9400	161
CM-CT 200/5	1SVR450116R5400	263	CM-IVN.S	1SVR750669R9400	161
CM-CT 300/1	1SVR450186R1100	263	CM-IWM.10	1SVR470670R1000	161
CM-CT 300/5	1SVR450186R5100	263	CM-IWM.11	1SVR470670R1100	161
CM-CT 400/1	1SVR450186R1890	263	CM-IWN.1P	1SVR760660R0200	161
CM-CT 400/5	1SVR450186R5200	263	CM-IWN.1S	1SVR750660R0200	161
CM-CT 50/1	1SVR450116R1000	263	CM-IWS.1P	1SVR740660R0100	161
CM-CT 50/5	1SVR450116R5000	263	CM-IWS.1S	1SVR730660R0100	161
CM-CT 500/1	1SVR450186R1300	263	CM-IWS.2P	1SVR740670R0200	161
CM-CT 500/5	1SVR450186R5300	263	CM-IWS.2S	1SVR730670R0200	161
CM-CT 600/1	1SVR450186R1400	263	CM-KH-3	1SVR450056R6000	262
CM-CT 600/5	1SVR450186R5400	263	CM-MPN.52P	1SVR760487R8300	115
CM-CT 145/1	1SVR450116R1100	263	CM-MPN.52S	1SVR750487R8300	115
CM-CT 145/5	1SVR450116R5100	263	CM-MPN.62P	1SVR760488R8300	115
CM-CT A	1SVR450118R1000	263	CM-MPN.62S	1SVR750488R8300	115
CM-EFS.2P	1SVR740750R0400	89	CM-MPN.72P	1SVR760489R8300	115
CM-EFS.2S	1SVR730750R0400	89	CM-MPN.72S	1SVR750489R8300	115
CM-ENE MAX	1SVR550855R9400	249	CM-MPS.11P	1SVR740885R1300	115
CM-ENE MAX	1SVR550850R9400	249	CM-MPS.11S	1SVR730885R1300	115
CM-ENE MAX	1SVR550851R9400	249	CM-MPS.21P	1SVR740885R3300	115
CM-ENE MIN	1SVR550855R9500	249	CM-MPS.21S	1SVR730885R3300	115
CM-ENE MIN	1SVR550850R9500	249	CM-MPS.23P	1SVR740885R4300	115
CM-ENE MIN	1SVR550851R9500	249	CM-MPS.23S	1SVR730885R4300	115
CM-ENS.11P	1SVR730850R2100	249	CM-MPS.31P	1SVR740884R1300	115
CM-ENS.11S	1SVR730850R0100	249	CM-MPS.31S	1SVR730884R1300	115
CM-ENS.13P	1SVR740850R2100	249	CM-MPS.41P	1SVR740884R3300	115
CM-ENS.13S	1SVR740850R0100	249	CM-MPS.41S	1SVR730884R3300	115
CM-ENS.21P	1SVR740850R0200	249	CM-MPS.43P	1SVR740884R4300	115
CM-ENS.21S	1SVR730850R0200	249	CM-MPS.43S	1SVR730884R4300	115
CM-ENS.23P	1SVR740850R2200	249	CM-MSE	1SVR550800R9300	189
CM-ENS.23S	1SVR730850R2200	249	CM-MSS.11P	1SVR740720R1400	189
CM-ENS.31P	1SVR740850R0300	249	CM-MSS.11S	1SVR730720R1400	189

Index

Measuring and monitoring relays Product type

Type	Order code	Page	Type	Order code	Page
CM-MSS.12P	1SVR740700R0100	189	CM-SRS.11S	1SVR730840R0200	86
CM-MSS.12S	1SVR730700R0100	189	CM-SRS.11S	1SVR730841R0200	86
CM-MSS.13P	1SVR740700R2100	189	CM-SRS.11S	1SVR730841R1890	86
CM-MSS.13S	1SVR730700R2100	189	CM-SRS.12S	1SVR730840R0300	86
CM-MSS.21P	1SVR740722R1400	189	CM-SRS.12S	1SVR730841R0300	86
CM-MSS.21S	1SVR730722R1400	189	CM-SRS.12S	1SVR730841R1300	86
CM-MSS.22P	1SVR740700R0200	189	CM-SRS.21P	1SVR740840R0400	86
CM-MSS.22S	1SVR730700R0200	189	CM-SRS.21P	1SVR740841R0400	86
CM-MSS.23P	1SVR740700R2200	189	CM-SRS.21P	1SVR740841R1400	86
CM-MSS.23S	1SVR730700R2200	189	CM-SRS.21S	1SVR730840R0400	86
CM-MSS.31P	1SVR740712R1400	189	CM-SRS.21S	1SVR730841R0400	86
CM-MSS.31S	1SVR730712R1400	189	CM-SRS.21S	1SVR730841R1400	86
CM-MSS.32P	1SVR740712R0200	189	CM-SRS.22S	1SVR730840R0500	86
CM-MSS.32S	1SVR730712R0200	189	CM-SRS.22S	1SVR730841R0500	86
CM-MSS.33P	1SVR740712R2200	189	CM-SRS.22S	1SVR730841R1500	86
CM-MSS.33S	1SVR730712R2200	189	CM-SRS.M1P	1SVR740840R0600	86
CM-MSS.41P	1SVR740712R1890	189	CM-SRS.M1S	1SVR730840R0600	86
CM-MSS.41S	1SVR730712R1890	189	CM-SRS.M2S	1SVR730840R0700	86
CM-MSS.51P	1SVR740712R1300	189	CM-TCN.011S	1SVR750740R0110	230
CM-MSS.51S	1SVR730712R1300	189	CM-TCN.011P	1SVR760740R0110	230
CM-PAS.31P	1SVR740774R1300	112	CM-TCN.012S	1SVR760740R0120	230
CM-PAS.31S	1SVR730774R1300	112	CM-TCN.012P	1SVR750740R0120	230
CM-PAS.41P	1SVR740774R3300	112	CM-TCS.11P	1SVR740740R0100	209
CM-PAS.41S	1SVR730774R3300	112	CM-TCS.11S	1SVR730740R0100	209
CM-PBE	1SVR550881R9400	112	CM-TCS.12P	1SVR740740R0200	209
CM-PBE	1SVR550882R9500	112	CM-TCS.12S	1SVR730740R0200	209
CM-PFE	1SVR550824R9100	112	CM-TCS.13P	1SVR740740R0300	209
CM-PFE.2	1SVR550826R9100	112	CM-TCS.13S	1SVR730740R0300	209
CM-PFS.P	1SVR740824R9300	112	CM-TCS.21P	1SVR740740R9100	209
CM-PFS.S	1SVR730824R9300	112	CM-TCS.21S	1SVR730740R9100	209
CM-PSS.31P	1SVR740784R2300	112	CM-TCS.22P	1SVR740740R9200	209
CM-PSS.31S	1SVR730784R2300	112	CM-TCS.22S	1SVR730740R9200	209
CM-PSS.41P	1SVR740784R3300	112	CM-TCS.23P	1SVR740740R9300	209
CM-PSS.41S	1SVR730784R3300	112	CM-TCS.23S	1SVR730740R9300	209
CM-PVE	1SVR550870R9400	112	CM-UFD.M22M	1SVR560731R3700	145
CM-PVE	1SVR550871R9500	112	CM-UFD.M31	1SVR560730R3401	145
CM-PVS.31P	1SVR740794R1300	112	CM-UFD.M31M	1SVR560731R3701	145
CM-PVS.31S	1SVR730794R1300	112	CM-UFD.M33	1SVR560730R3402	145
CM-PVS.41P	1SVR740794R3300	112	CM-UFD.M33M	1SVR560731R3702	145
CM-PVS.41S	1SVR730794R3300	112	CM-UFD.M34M	1SVR560731R3703	145
CM-PVS.81P	1SVR740794R2300	112	COV.01	1SVR430005R0100	262
CM-PVS.81S	1SVR730794R2300	112	COV.02	1SVR440005R0100	262
CM-SE-1000	1SVR450056R0200	262	COV.11	1SVR730005R0100	262
CM-SE-300	1SVR450056R0000	262	COV.12	1SVR750005R0100	262
CM-SE-600	1SVR450056R0100	262	MAR.01	1SVR366086R0100	262
CM-SFS.21P	1SVR740760R0400	86	MAR.02	1SVR430043R0000	262
CM-SFS.21S	1SVR730760R0400	86	MAR.12	1SVR730006R0000	262
CM-SFS.22S	1SVR730760R0500	86			
CM-SRS.11P	1SVR740840R0200	86			
CM-SRS.11P	1SVR740841R0200	86			
CM-SRS.11P	1SVR740841R1890	86			

Index

Measuring and monitoring relays

Order code

Order code	Type	Page	Order code	Type	Page
1SVR366017R0100	MAR.01	172	1SVR560731R3700	CM-UFD.M22M	145
1SVR402902R0000	CM-HE	172	1SVR560731R3701	CM-UFD.M31M	145
1SVR402902R1000	CM-HC	172	1SVR560731R3702	CM-UFD.M33M	145
1SVR402902R2000	CM-HCT	172	1SVR560731R3703	CM-UFD.M34M	145
1SVR1120005R0100	COV.01	172	1SVR730005R0100	COV.11	172
1SVR1120029R0100	ADP.01	172	1SVR730006R0000	MAR.12	172
1SVR11200112R0000	MAR.02	172	1SVR730660R0100	CM-IWS.1S	161
1SVR440005R0100	COV.02	172	1SVR730670R0200	CM-IWS.2S	161
1SVR440029R0100	ADP.02	172	1SVR730700R0100	CM-MSS.12S	189
1SVR1150056R0000	CM-SE-300	172	1SVR730700R0200	CM-MSS.22S	189
1SVR1150056R0100	CM-SE-600	172	1SVR730700R2100	CM-MSS.13S	189
1SVR1150056R0200	CM-SE-1000	172	1SVR730700R2200	CM-MSS.23S	189
1SVR1150056R6000	CM-KH-3	172	1SVR730712R0200	CM-MSS.32S	189
1SVR1150056R7000	CM-AH-3	172	1SVR730712R1200	CM-MSS.41S	189
1SVR1150056R8000	CM-GM-1	172	1SVR730712R1300	CM-MSS.51S	189
1SVR1150116R1000	CM-CT 50/1	263	1SVR730712R1400	CM-MSS.31S	189
1SVR1150116R1100	CM-CT 145/1	263	1SVR730712R2200	CM-MSS.33S	189
1SVR1150116R1200	CM-CT 100/1	263	1SVR730720R1400	CM-MSS.11S	189
1SVR1150116R1300	CM-CT 150/1	263	1SVR730722R1400	CM-MSS.21S	189
1SVR1150116R1400	CM-CT 200/1	263	1SVR730740R0100	CM-TCS.11S	209
1SVR1150116R5000	CM-CT 50/5	263	1SVR730740R0200	CM-TCS.12S	209
1SVR1150116R5100	CM-CT 145/5	263	1SVR730740R0300	CM-TCS.13S	209
1SVR1150116R5200	CM-CT 100/5	263	1SVR730740R16100	CM-TCS.21S	209
1SVR1150116R5300	CM-CT 150/5	263	1SVR730740R9200	CM-TCS.22S	209
1SVR1150116R5400	CM-CT 200/5	263	1SVR730740R9300	CM-TCS.23S	209
1SVR1150117R1100	CM-CT 300/1	263	1SVR730750R0400	CM-EFS.2S	89
1SVR1150117R1200	CM-CT 400/1	263	1SVR730760R0400	CM-SFS.21S	86
1SVR1150117R1300	CM-CT 500/1	263	1SVR730760R0500	CM-SFS.22S	86
1SVR1150117R1400	CM-CT 600/1	263	1SVR730774R1300	CM-PAS.31S	112
1SVR1150117R5100	CM-CT 300/5	263	1SVR730774R3300	CM-PAS.41S	112
1SVR1150117R5200	CM-CT 400/5	263	1SVR730784R2300	CM-PSS.31S	112
1SVR1150117R5300	CM-CT 500/5	263	1SVR730784R3300	CM-PSS.41S	112
1SVR1150117R5400	CM-CT 600/5	263	1SVR730794R1300	CM-PVS.31S	112
1SVR1150118R1000	CM-CT A	263	1SVR730794R2300	CM-PVS.81S	112
1SVR470670R1000	CM-IWM.10	161	1SVR730794R3300	CM-PVS.41S	112
1SVR470670R1100	CM-IWM.11	161	1SVR730824R9300	CM-PFS.S	112
1SVR550800R9300	CM-MSE	189	1SVR730830R0300	CM-ESS.1S	89
1SVR550824R16100	CM-PFE	112	1SVR730830R0400	CM-ESS.2S	89
1SVR550826R16100	CM-PFE.2	112	1SVR730830R0500	CM-ESS.MS	89
1SVR550850R9400	CM-ENE MAX	249	1SVR730831R0300	CM-ESS.1S	89
1SVR550850R9500	CM-ENE MIN	249	1SVR730831R0400	CM-ESS.2S	89
1SVR550851R9400	CM-ENE MAX	249	1SVR730831R1300	CM-ESS.1S	89
1SVR550851R9500	CM-ENE MIN	249	1SVR730831R1400	CM-ESS.2S	89
1SVR550855R9400	CM-ENE MAX	249	1SVR730840R0200	CM-SRS.11S	86
1SVR550855R9500	CM-ENE MIN	249	1SVR730840R0300	CM-SRS.12S	86
1SVR550870R9400	CM-PVE	112	1SVR730840R0400	CM-SRS.21S	86
1SVR550871R9500	CM-PVE	112	1SVR730840R0500	CM-SRS.22S	86
1SVR550881R9400	CM-PBE	112	1SVR730840R0600	CM-SRS.M1S	86
1SVR550882R9500	CM-PBE	112	1SVR730840R0700	CM-SRS.M2S	86
1SVR560730R3401	CM-UFD.M31	145	1SVR730841R0200	CM-SRS.11S	86
1SVR560730R3402	CM-UFD.M33	145	1SVR730841R0300	CM-SRS.12S	86

Index

Measuring and monitoring relays

Order code

Order code	Type	Page	Order code	Type	Page
1SVR730841R0400	CM-SRS.21S	86	1SVR740831R1300	CM-ESS.1P	89
1SVR730841R0500	CM-SRS.22S	86	1SVR740831R1400	CM-ESS.2P	89
1SVR730841R1200	CM-SRS.11S	86	1SVR740840R0200	CM-SRS.11P	86
1SVR730841R1300	CM-SRS.12S	86	1SVR740840R0400	CM-SRS.21P	86
1SVR730841R1400	CM-SRS.21S	86	1SVR740840R0600	CM-SRS.M1P	86
1SVR730841R1500	CM-SRS.22S	86	1SVR740841R0200	CM-SRS.11P	86
1SVR730850R0100	CM-ENS.11S	249	1SVR740841R0400	CM-SRS.21P	86
1SVR730850R0200	CM-ENS.21S	249	1SVR740841R1200	CM-SRS.11P	86
1SVR730850R0300	CM-ENS.31S	249	1SVR740841R1400	CM-SRS.21P	86
1SVR730850R2100	CM-ENS.11P	249	1SVR740850R0100	CM-ENS.13S	249
1SVR730850R2200	CM-ENS.23S	249	1SVR740850R0200	CM-ENS.21P	249
1SVR730884R1300	CM-MPS.31S	115	1SVR740850R0300	CM-ENS.31P	249
1SVR730884R3300	CM-MPS.41S	115	1SVR740850R2100	CM-ENS.13P	249
1SVR730884R11200	CM-MPS.112S	115	1SVR740850R2200	CM-ENS.23P	249
1SVR730885R1300	CM-MPS.11S	115	1SVR740884R1300	CM-MPS.31P	115
1SVR730885R3300	CM-MPS.21S	115	1SVR740884R3300	CM-MPS.41P	115
1SVR730885R11200	CM-MPS.23S	115	1SVR740884R11200	CM-MPS.112P	115
1SVR740660R0100	CM-IWS.1P	161	1SVR740885R1300	CM-MPS.11P	115
1SVR740670R0200	CM-IWS.2P	161	1SVR740885R3300	CM-MPS.21P	115
1SVR740700R0100	CM-MSS.12P	189	1SVR740885R11200	CM-MPS.23P	115
1SVR740700R0200	CM-MSS.22P	189	1SVR750005R0100	COV.12	172
1SVR740700R2100	CM-MSS.13P	189	1SVR750487R8300	CM-MPN.52S	115
1SVR740700R2200	CM-MSS.23P	189	1SVR750488R8300	CM-MPN.62S	115
1SVR740712R0200	CM-MSS.32P	189	1SVR750489R8300	CM-MPN.72S	115
1SVR740712R1200	CM-MSS.41P	189	1SVR750660R0200	CM-IWN.1S	161
1SVR740712R1300	CM-MSS.51P	189	1SVR750669R9400	CM-IVN.S	161
1SVR740712R1400	CM-MSS.31P	189	1SVR750740R0110	CM-TCN.011S	230
1SVR740712R2200	CM-MSS.33P	189	1SVR750740R0120	CM-TCN.012P	230
1SVR740720R1400	CM-MSS.11P	189	1SVR760740R0110	CM-TCN.011P	230
1SVR740722R1400	CM-MSS.21P	189	1SVR760740R0120	CM-TCN.012S	230
1SVR740740R0100	CM-TCS.11P	209	1SVR760487R8300	CM-MPN.52P	115
1SVR740740R0200	CM-TCS.12P	209	1SVR760488R8300	CM-MPN.62P	115
1SVR740740R0300	CM-TCS.13P	209	1SVR760489R8300	CM-MPN.72P	115
1SVR740740R16100	CM-TCS.21P	209	1SVR760660R0200	CM-IWN.1P	161
1SVR740740R9200	CM-TCS.22P	209	1SVR760669R9400	CM-IVN.P	161
1SVR740740R9300	CM-TCS.23P	209	GHC0110003R0001	C011-70	121
1SVR740750R0400	CM-EFS.2P	89	GHC0110003R0002	C011-80	121
1SVR740760R0400	CM-SFS.21P	86	GHC0110003R0003	C011-90	121
1SVR740774R1300	CM-PAS.31P	112	GHC0110003R0004	C011-100	121
1SVR740774R3300	CM-PAS.41P	112	GHC0110003R0005	C011-110	121
1SVR740784R2300	CM-PSS.31P	112	GHC0110003R0006	C011-189	121
1SVR740784R3300	CM-PSS.41P	112	GHC0110003R0007	C011-130	121
1SVR740794R1300	CM-PVS.31P	112	GHC0110003R0008	C011-150	121
1SVR740794R2300	CM-PVS.81P	112	GHC0110003R0009	C011-160	121
1SVR740794R3300	CM-PVS.41P	112	GHC0110003R0010	C011-170	121
1SVR740824R9300	CM-PFS.P	112	GHC0110003R0011	C011-140	121
1SVR740830R0300	CM-ESS.1P	89	GHC0110033R0008	C011-3-150	121
1SVR740830R0400	CM-ESS.2P	89			
1SVR740830R0500	CM-ESS.MP	89			
1SVR740831R0300	CM-ESS.1P	89			
1SVR740831R0400	CM-ESS.2P	89			

Index

Power Supplies Product type

Type	Order code	Page	Type	Order code	Page
CP-B 24/10.0	1SVR427060R1000	105	EPD24-TB-101-1A	2CDE601101R2001	128
CP-B 24/20.0	1SVR427060R2000	105	EPD24-TB-101-2A	2CDE601101R2002	128
CP-B 24/3.0	1SVR427060R0300	105	EPD24-TB-101-3A	2CDE601101R2003	128
CP-C.1 24/10.0	1SVR360663R1001	70	EPD24-TB-101-4A	2CDE601101R2004	128
CP-C.1 24/10.0-C	1SVR360663R2001	70	EPD24-TB-101-6A	2CDE601101R2006	128
CP-C.1 24/10.0-L	1SVR361663R1001	70	EPD24-TB-101-8A	2CDE601101R2008	128
CP-C.1 24/20.0	1SVR360763R1001	70	EPD-BB500	2CDE605100R0500	128
CP-C.1 24/20.0-C	1SVR360763R2001	70	EPD-SB21	2CDE605200R0021	128
CP-C.1 24/20.0-L	1SVR361763R1001	70			
CP-C.1 24/5.0	1SVR360563R1001	70			
CP-C.1 24/5.0-C	1SVR360563R2001	70			
CP-C.1 24/5.0-L	1SVR361563R1001	70			
CP-C.1-A-RU	1SVR360060R1001	118			
CP-C.1-A-RU-C	1SVR360060R2001	118			
CP-C.1-A-RU-L	1SVR361060R1001	118			
CP-D 12/0.83	1SVR427041R1000	94			
CP-D 12/2.1	1SVR427043R1200	94			
CP-D 24/0.42	1SVR427041R0000	94			
CP-D 24/1.3	1SVR427043R0100	94			
CP-D 24/2.5	1SVR427044R0200	94			
CP-D 24/4.2	1SVR427045R0400	94			
CP-D RU	1SVR427049R0000	118			
CP-E 12/10.0	1SVR427035R1000	18			
CP-E 12/2.5	1SVR427032R1000	18			
CP-E 24/0.75	1SVR427030R0000	18			
CP-E 24/1.25	1SVR427031R0000	18			
CP-E 24/10.0	1SVR427035R0000	18			
CP-E 24/2.5	1SVR427032R0000	18			
CP-E 24/20.0	1SVR427036R0000	18			
CP-E 24/5.0	1SVR427034R0000	18			
CP-E 48/0.62	1SVR427030R2000	18			
CP-E 48/1.25	1SVR427031R2000	18			
CP-E 48/10.0	1SVR427035R2000	18			
CP-E 48/5.0	1SVR427034R2000	18			
CP-E 5/3.0	1SVR427033R3000	18			
CP-S.1 24/3.0	1SVR320361R1000	56			
CP-S.1 24/5.0	1SVR320561R1000	56			
CP-S.1 24/10.0	1SVR320661R1000	56			
CP-S.1 24/20.0	1SVR320761R1000	56			
CP-S.1 24/40.0	1SVR320861R1000	56			
CP-C.1-A-RU	1SVR360060R1001	56			
CP-T 24/10.0	1SVR427055R0000	38			
CP-T 24/20.0	1SVR427056R0000	38			
CP-T 24/40.0	1SVR427057R0000	38			
CP-T 24/5.0	1SVR427054R0000	38			
CP-T 48/10.0	1SVR427055R2000	38			
CP-T 48/20.0	1SVR427056R2000	38			
CP-T 48/5.0	1SVR427054R2000	38			
EPD24-TB-101-0.5A	2CDE601101R2905	128			
EPD24-TB-101-10A	2CDE601101R2010	128			
EPD24-TB-101-12A	2CDE601101R2012	128			

Index

Power Supplies

Order code

Order code	Type	Page
1SVR360060R1001	CP-C.1-A-RU	118
1SVR360060R2001	CP-C.1-A-RU-C	118
1SVR360563R1001	CP-C.1 24/5.0	70
1SVR360563R2001	CP-C.1 24/5.0-C	70
1SVR360663R1001	CP-C.1 24/10.0	70
1SVR360663R2001	CP-C.1 24/10.0-C	70
1SVR360763R1001	CP-C.1 24/20.0	70
1SVR360763R2001	CP-C.1 24/20.0-C	70
1SVR361060R1001	CP-C.1-A-RU-L	118
1SVR361563R1001	CP-C.1 24/5.0-L	70
1SVR361663R1001	CP-C.1 24/10.0-L	70
1SVR361763R1001	CP-C.1 24/20.0-L	70
1SVR320361R1000	CP-S.1 24/3.0	56
1SVR320561R1000	CP-S.1 24/5.0	56
1SVR320661R1000	CP-S.1 24/10.0	56
1SVR320761R1000	CP-S.1 24/20.0	56
1SVR320861R1000	CP-S.1 24/40.0	56
1SVR360060R1001	CP-C.1-A-RU	118
1SVR427030R0000	CP-E 24/0.75	18
1SVR427030R2000	CP-E 48/0.62	18
1SVR427031R0000	CP-E 24/1.25	18
1SVR427031R2000	CP-E 48/1.25	18
1SVR427032R0000	CP-E 24/2.5	18
1SVR427032R1000	CP-E 12/2.5	18
1SVR427033R3000	CP-E 5/3.0	18
1SVR427034R0000	CP-E 24/5.0	18
1SVR427034R2000	CP-E 48/5.0	18
1SVR427035R0000	CP-E 24/10.0	18
1SVR427035R1000	CP-E 12/10.0	18
1SVR427035R2000	CP-E 48/10.0	18
1SVR427036R0000	CP-E 24/20.0	18
1SVR427041R0000	CP-D 24/0.42	94
1SVR427041R1000	CP-D 12/0.83	94
1SVR427043R0100	CP-D 24/1.3	94
1SVR427043R1200	CP-D 12/2.1	94
1SVR427044R0200	CP-D 24/2.5	94
1SVR427045R0400	CP-D 24/4.2	94
1SVR427049R0000	CP-D RU	118
1SVR427054R0000	CP-T 24/5.0	38
1SVR427054R2000	CP-T 48/5.0	38
1SVR427055R0000	CP-T 24/10.0	38
1SVR427055R2000	CP-T 48/10.0	38
1SVR427056R0000	CP-T 24/20.0	38
1SVR427056R2000	CP-T 48/20.0	38
1SVR427057R0000	CP-T 24/40.0	38
1SVR427060R0300	CP-B 24/3.0	108
1SVR427060R1000	CP-B 24/10.0	108
1SVR427060R2000	CP-B 24/20.0	108
2CDE601101R2001	EPD24-TB-101-1A	329
2CDE601101R2002	EPD24-TB-101-2A	329
2CDE601101R2003	EPD24-TB-101-3A	329

Order code	Type	Page
2CDE601101R2004	EPD24-TB-101-4A	329
2CDE601101R2006	EPD24-TB-101-6A	329
2CDE601101R2008	EPD24-TB-101-8A	329
2CDE601101R2010	EPD24-TB-101-10A	329
2CDE601101R2012	EPD24-TB-101-12A	329
2CDE601101R2905	EPD24-TB-101-0.5A	329
2CDE605100R0500	EPD-BB500	329
2CDE605200R0021	EPD-SB21	329

Index

Interface relays and optocouplers

Product type

Type	Order code	Page	Type	Order code	Page
CR-M012AC2L	1SVR405611R0300	438	CR-M048DC2L	1SVR405611R6100	438
CR-M012AC3L	1SVR405612R0300	438	CR-M048DC2LD	1SVR405611R6400	439
CR-M012AC4L	1SVR405613R0300	438	CR-M048DC3	1SVR405612R6000	414
CR-M012DC2	1SVR405611R4000	414	CR-M048DC3L	1SVR405612R6100	438
CR-M012DC2L	1SVR405611R4100	438	CR-M048DC3LD	1SVR405612R6400	439
CR-M012DC2LD	1SVR405611R4400	439	CR-M048DC4	1SVR405613R6000	414
CR-M012DC3	1SVR405612R4000	414	CR-M048DC4L	1SVR405613R6100	438
CR-M012DC3L	1SVR405612R4100	438	CR-M048DC4LD	1SVR405613R6400	439
CR-M012DC3LD	1SVR405612R4400	439	CR-M048DC4LG	1SVR405618R6100	440
CR-M012DC4	1SVR405613R4000	414	CR-M060AC3	1SVR405612R5200	414
CR-M012DC4L	1SVR405613R4100	438	CR-M060DC2	1SVR405611R4200	414
CR-M012DC4LD	1SVR405613R4400	439	CR-M060DC2L	1SVR405611R4300	438
CR-M012DC4LDG	1SVR405618R4400	440	CR-M060DC3	1SVR405612R4200	414
CR-M012DC4LDGSS	1SVR405618R4410	420	CR-M060DC3L	1SVR405612R4300	438
CR-M012DC4LG	1SVR405618R4100	440	CR-M060DC4	1SVR405613R4200	414
CR-M024AC2	1SVR405611R0000	414	CR-M060DC4L	1SVR405613R4300	438
CR-M024AC2L	1SVR405611R0100	438	CR-M060DC4LG	1SVR405618R4300	440
CR-M024AC3	1SVR405612R0000	414	CR-M110AC2	1SVR405611R7000	414
CR-M024AC3L	1SVR405612R0100	438	CR-M110AC2L	1SVR405611R7100	438
CR-M024AC4	1SVR405613R0000	414	CR-M110AC3	1SVR405612R7000	414
CR-M024AC4G	1SVR405618R0000	439	CR-M110AC3L	1SVR405612R7100	438
CR-M024AC4L	1SVR405613R0100	438	CR-M110AC4	1SVR405613R7000	414
CR-M024AC4LG	1SVR405618R0100	440	CR-M110AC4G	1SVR405618R7000	439
CR-M024AC4LS62CV	1SVR405613R0010	420	CR-M110AC4L	1SVR405613R7100	438
CR-M024DC2	1SVR405611R1000	414	CR-M110AC4LG	1SVR405618R7100	440
CR-M024DC2L	1SVR405611R1100	438	CR-M110DC2	1SVR405611R8000	414
CR-M024DC2LD	1SVR405611R1400	439	CR-M110DC2L	1SVR405611R8100	438
CR-M024DC3	1SVR405612R1000	414	CR-M110DC2LD	1SVR405611R8400	439
CR-M024DC3L	1SVR405612R1100	438	CR-M110DC3	1SVR405612R8000	414
CR-M024DC3LD	1SVR405612R1400	439	CR-M110DC3L	1SVR405612R8100	438
CR-M024DC4	1SVR405613R1000	414	CR-M110DC3LD	1SVR405612R8400	439
CR-M024DC4G	1SVR405618R1000	439	CR-M110DC4	1SVR405613R8000	414
CR-M024DC4GLC62CV	1SVR405618R1010	420	CR-M110DC4L	1SVR405613R8100	438
CR-M024DC4GSS42V	1SVR405618R1011	420	CR-M110DC4LD	1SVR405613R8400	439
CR-M024DC4L	1SVR405613R1100	438	CR-M110DC4LG	1SVR405618R8100	440
CR-M024DC4LC42	1SVR405613R1012	420	CR-M120AC2	1SVR405611R2000	414
CR-M024DC4LD	1SVR405614R1100	439	CR-M120AC2L	1SVR405611R2100	438
CR-M024DC4LDG	1SVR405618R1400	440	CR-M120AC3	1SVR405612R2000	414
CR-M024DC4LDGSS	1SVR405618R1410	420	CR-M120AC3L	1SVR405612R2100	438
CR-M024DC4LG	1SVR405618R1100	440	CR-M120AC4	1SVR405613R2000	414
CR-M024DC4LGLC22	1SVR405618R1110	420	CR-M120AC4L	1SVR405613R2100	438
CR-M024DC4LS42V	1SVR405613R1011	420	CR-M120AC4LG	1SVR405618R2100	440
CR-M024DC4SS42V	1SVR405613R1010	420	CR-M125DC2	1SVR405611R8200	414
CR-M048AC2	1SVR405611R5000	414	CR-M125DC2L	1SVR405611R8300	438
CR-M048AC2L	1SVR405611R5100	438	CR-M125DC2LD	1SVR405611R8500	439
CR-M048AC3	1SVR405612R5000	414	CR-M125DC3	1SVR405612R8200	414
CR-M048AC3L	1SVR405612R5100	438	CR-M125DC3L	1SVR405612R8300	438
CR-M048AC4	1SVR405613R5000	414	CR-M125DC3LD	1SVR405612R8500	439
CR-M048AC4L	1SVR405613R5100	438	CR-M125DC4	1SVR405613R8200	414
CR-M048AC4LG	1SVR405618R5100	440	CR-M125DC4L	1SVR405613R8300	438
CR-M048DC2	1SVR405611R6000	414	CR-M125DC4LD	1SVR405613R8500	439

Index

Interface relays and optocouplers

Product type

Type	Order code	Page	Type	Order code	Page
CR-M125DC4LG	1SVR405618R8300	440	CR-P/M 52D	1SVR405653R4000	421
CR-M220DC2	1SVR405611R9000	414	CR-P/M 62	1SVR405654R0000	421
CR-M220DC2L	1SVR405611R9100	438	CR-P/M 62 C	1SVR405655R0000	422
CR-M220DC2LD	1SVR405611R9400	439	CR-P/M 62 CV	1SVR405655R1000	422
CR-M220DC3	1SVR405612R9000	414	CR-P/M 62 D	1SVR405655R4000	422
CR-M220DC3L	1SVR405612R9100	438	CR-P/M 62 DV	1SVR405655R4100	422
CR-M220DC3LD	1SVR405612R9400	439	CR-P/M 62 E	1SVR405654R4000	421
CR-M220DC4	1SVR405613R9000	414	CR-P/M 62 EV	1SVR405654R4100	421
CR-M220DC4L	1SVR405613R9100	438	CR-P/M 62 V	1SVR405654R1000	421
CR-M220DC4LD	1SVR405613R9400	439	CR-P/M 72	1SVR405656R0000	422
CR-M220DC4LG	1SVR405618R9100	440	CR-P/M 72 A	1SVR405656R1000	422
CR-M230AC2	1SVR405611R3000	414	CR-P/M 82	1SVR405656R2000	422
CR-M230AC2L	1SVR405611R3100	438	CR-P/M 92	1SVR405654R0100	421
CR-M230AC3	1SVR405612R3000	414	CR-P/M 92 C	1SVR405655R0100	422
CR-M230AC3L	1SVR405612R3100	438	CR-P/M 92 CV	1SVR405655R1100	422
CR-M230AC4	1SVR405613R3000	414	CR-P/M 92 V	1SVR405654R1100	421
CR-M230AC4G	1SVR405618R3000	439	CR-P012AC2	1SVR405601R0200	433
CR-M230AC4GSS92CV	1SVR405618R3112	421	CR-P012DC1	1SVR405600R4000	433
CR-M230AC4L	1SVR405613R3100	438	CR-P012DC1S542V	1SVR405600R4010	412
CR-M230AC4LC92	1SVR405613R3012	421	CR-P012DC2	1SVR405601R4000	433
CR-M230AC4LG	1SVR405618R3100	440	CR-P012DC2S542V	1SVR405601R4010	413
CR-M230AC4LGLC	1SVR405618R3110	421	CR-P024AC1	1SVR405600R0000	433
CR-M230AC4LGSS	1SVR405618R3111	421	CR-P024AC1S562CV	1SVR405600R0010	412
CR-M230AC4LS92CV	1SVR405613R3011	421	CR-P024AC2	1SVR405601R0000	433
CR-M230AC4SS92CV	1SVR405613R3110	421	CR-P024AC2G	1SVR405606R0000	433
CR-M2LC	1SVR405651R1200	420	CR-P024AC2S562CV	1SVR405601R0010	413
CR-M2LS	1SVR405651R1100	420	CR-P024DC1	1SVR405600R1000	433
CR-M2LSH	1SVR405651R4100	420	CR-P024DC1LC42V	1SVR405600R1011	412
CR-M2SF	1SVR405651R1300	420	CR-P024DC1LC62C	1SVR405600R1013	412
CR-M2SS	1SVR405651R1000	420	CR-P024DC1S542V	1SVR405600R1010	412
CR-M3LS	1SVR405651R2100	420	CR-P024DC2	1SVR405601R1000	433
CR-M3LSH	1SVR405651R5100	420	CR-P024DC2G	1SVR405606R1000	433
CR-M3SS	1SVR405651R2000	420	CR-P024DC2GLC42V	1SVR405606R1010	413
CR-M4LC	1SVR405651R3200	420	CR-P024DC2GLC62C	1SVR405606R1013	413
CR-M4LS	1SVR405651R3100	420	CR-P024DC2GLC62CV	1SVR405606R1011	413
CR-M4SF	1SVR405651R3300	420	CR-P024DC2LC42	1SVR405601R1012	413
CR-M4SS	1SVR405651R3000	420	CR-P024DC2LS42	1SVR405601R1013	413
CR-MH	1SVR405659R1000	420	CR-P024DC2LS42V	1SVR405601R1011	413
CR-MH1	1SVR405659R1100	420	CR-P024DC2S542V	1SVR405601R1010	413
CR-MJ	1SVR405658R6000	420	CR-P024MOS1	1SVR405610R4060	433
CR-MM	1SVR405658R1000	420	CR-P024TRI1	1SVR405610R4070	433
CR-MP	1SVR405658R2000	420	CR-P048AC1	1SVR405600R5000	433
CR-P/M 22	1SVR405651R0000	421	CR-P048AC2	1SVR405601R5000	433
CR-P/M 42	1SVR405652R0000	421	CR-P048DC1	1SVR405600R6000	433
CR-P/M 42 B	1SVR405652R4000	421	CR-P048DC2	1SVR405601R6000	433
CR-P/M 42 BV	1SVR405652R4100	421	CR-P110AC1	1SVR405600R7000	433
CR-P/M 42 C	1SVR405652R9000	421	CR-P110AC2	1SVR405601R7000	433
CR-P/M 42 CV	1SVR405652R9100	421	CR-P110AC2G	1SVR405606R7000	433
CR-P/M 42 V	1SVR405652R1000	421	CR-P110DC1	1SVR405600R8000	433
CR-P/M 52B	1SVR405653R0000	421	CR-P110DC1S542CV	1SVR405600R8010	412
CR-P/M 52C	1SVR405653R1000	421	CR-P110DC2	1SVR405601R8000	433

Index

Interface relays and optocouplers

Product type

Type	Order code	Page	Type	Order code	Page
CR-P110DC2SS42CV	1SVR405601R8010	413	CR-S110VADC1CRGZ	1SVR405541R6220	429
CR-P120AC1	1SVR405600R2000	433	CR-S110VADC1CRS	1SVR405541R6110	429
CR-P120AC1SS92CV	1SVR405600R2010	412	CR-S110VADC1CRZ	1SVR405541R6210	429
CR-P120AC2	1SVR405601R2000	433	CR-S220/240VADC1SS	1SVR405521R7100	430
CR-P120AC2SS92CV	1SVR405601R2010	413	CR-S220/240VADC1SZ	1SVR405521R7200	430
CR-P230AC1	1SVR405600R3000	433	CR-S230VADC1CRGS	1SVR405541R7120	429
CR-P230AC1LC92CV	1SVR405600R3010	412	CR-S230VADC1CRGZ	1SVR405541R7220	429
CR-P230AC1LS	1SVR405600R3011	412	CR-S230VADC1CRS	1SVR405541R7110	429
CR-P230AC1SS92CV	1SVR405600R3110	412	CR-S230VADC1CRZ	1SVR405541R7210	429
CR-P230AC2	1SVR405601R3000	433	CR-SJB20-BLACK	1SVR405598R0900	430
CR-P230AC2G	1SVR405606R3000	433	CR-SJB20-BLUE	1SVR405598R0700	430
CR-P230AC2GLC92	1SVR405606R3013	413	CR-SJB20-RED	1SVR405598R0800	430
CR-P230AC2GLC92C	1SVR405606R3012	413	CR-SSEP	1SVR405599R0000	430
CR-P230AC2GLC92CV	1SVR405606R3010	413	CR-U 21	1SVR405661R0000	424
CR-P230AC2LC92	1SVR405601R3012	413	CR-U 41	1SVR405662R0000	424
CR-P230AC2LS92CV	1SVR405601R3011	413	CR-U 41B	1SVR405662R4000	424
CR-P230AC2SS92CV	1SVR405601R3110	413	CR-U 41BV	1SVR405662R4100	424
CR-PH	1SVR405659R0000	413	CR-U 41C	1SVR405662R9000	424
CR-PH1	1SVR405659R0100	413	CR-U 41CV	1SVR405662R9100	424
CR-PJ	1SVR405658R5000	413	CR-U 41V	1SVR405662R1000	424
CR-PLC	1SVR405650R0200	413	CR-U 51B	1SVR405663R0000	424
CR-PLS	1SVR405650R0000	413	CR-U 51C	1SVR405663R1000	424
CR-PLSX	1SVR405650R0100	413	CR-U 51D	1SVR405663R4000	424
CR-PM	1SVR405658R0000	413	CR-U 61	1SVR405664R0000	424
CR-PSS	1SVR405650R1000	413	CR-U 61C	1SVR405665R0000	424
CR-S005VDC1R	1SVR405501R1010	429	CR-U 61CV	1SVR405665R1000	424
CR-S005VDC1RG	1SVR405501R1020	429	CR-U 61D	1SVR405665R4000	424
CR-S006/024VDC1SS	1SVR405521R1100	430	CR-U 61DV	1SVR405665R4100	424
CR-S006/024VDC1SZ	1SVR405521R1200	430	CR-U 61E	1SVR405664R4000	424
CR-S012/024VADC1SS	1SVR405521R3100	430	CR-U 61EV	1SVR405664R4100	424
CR-S012/024VADC1SZ	1SVR405521R3200	430	CR-U 61V	1SVR405664R1000	424
CR-S012VDC1R	1SVR405501R2010	429	CR-U 71	1SVR405666R0000	424
CR-S012VDC1RG	1SVR405501R2020	429	CR-U 71A	1SVR405666R1000	424
CR-S024VADC1CRGS	1SVR405541R3120	429	CR-U 81	1SVR405666R2000	424
CR-S024VADC1CRGZ	1SVR405541R3220	429	CR-U 91	1SVR405664R0100	424
CR-S024VADC1CRS	1SVR405541R3110	429	CR-U 91C	1SVR405665R0100	424
CR-S024VADC1CRZ	1SVR405541R3210	429	CR-U 91CV	1SVR405665R1100	424
CR-S024VDC1MOS	1SVR405510R3060	429	CR-U 91V	1SVR405664R1100	424
CR-S024VDC1R	1SVR405501R3010	429	CR-U T	1SVR405667R0000	424
CR-S024VDC1RG	1SVR405501R3020	429	CR-U012AC2L	1SVR405621R0300	446
CR-S024VDC1TRA	1SVR405510R3050	429	CR-U012AC3L	1SVR405622R0300	447
CR-S024VDC1TRI	1SVR405510R3070	429	CR-U012DC2	1SVR405621R4000	446
CR-S048/060VADC1SS	1SVR405521R5100	430	CR-U012DC2L	1SVR405621R4100	446
CR-S048/060VADC1SZ	1SVR405521R5200	430	CR-U012DC2LD	1SVR405621R4400	447
CR-S048VDC1R	1SVR405501R4010	429	CR-U012DC3	1SVR405622R4000	446
CR-S048VDC1RG	1SVR405501R4020	429	CR-U012DC3L	1SVR405622R4100	447
CR-S060VDC1R	1SVR405501R5010	429	CR-U012DC3LD	1SVR405622R4400	447
CR-S060VDC1RG	1SVR405501R5020	429	CR-U024AC2	1SVR405621R0000	446
CR-S110/125VADC1SS	1SVR405521R6100	430	CR-U024AC2L	1SVR405621R0100	446
CR-S110/125VADC1SZ	1SVR405521R6200	430	CR-U024AC3	1SVR405622R0000	446
CR-S110VADC1CRGS	1SVR405541R6120	429	CR-U024AC3L	1SVR405622R0100	447

Index

Interface relays and optocouplers

Product type

Type	Order code	Page	Type	Order code	Page
CR-U024DC2	1SVR405621R1000	446	OBOA1000-230VUC	1SNA645028R0500	492
CR-U024DC2L	1SVR405621R1100	446	OBOA1000-24VDC	1SNA645027R2400	492
CR-U024DC2LD	1SVR405621R1400	447	OBOA2000-24VDC	1SNA645029R0600	485
CR-U024DC3	1SVR405622R1000	446	OBOC2000-115VUC	1SNA645054R0700	492
CR-U024DC3L	1SVR405622R1100	447	OBOC2000-230VUC	1SNA645026R2300	492
CR-U024DC3LD	1SVR405623R1100	447	OBOC2000-24VDC	1SNA645051R0400	492
CR-U048AC2	1SVR405621R5000	446	OBOC2000-24VUC	1SNA645025R2200	492
CR-U048AC2L	1SVR405621R5100	446	OBOC2000-446-60VUC	1SNA645053R0600	492
CR-U048AC3	1SVR405622R5000	446	OBOC2000-5-12VDC	1SNA645050R1700	492
CR-U048AC3L	1SVR405622R5100	447	OBOC5000-115VUC	1SNA645058R1300	492
CR-U048DC2	1SVR405621R6000	446	OBOC5000-24VDC	1SNA645024R2100	492
CR-U048DC2L	1SVR405621R6100	446	OBRIC0100-115-230	1SNA645522R2100	492
CR-U048DC2LD	1SVR405621R6400	447	OBRIC0100-24VDC	1SNA645521R2000	492
CR-U048DC3	1SVR405622R6000	446	OBRIC0100-446-60VUC	1SNA645549R1400	492
CR-U048DC3L	1SVR405622R6100	447	OBRIC0100-5-12VDC	1SNA645547R0200	492
CR-U048DC3LD	1SVR405622R6400	447	OBROA1000-24VDC	1SNA645527R2600	492
CR-U060AC3	1SVR405622R5200	446	OBROA2000-24VDC	1SNA645529R0000	485
CR-U110AC2	1SVR405621R7000	446	OBROC2000-230VUC	1SNA645526R2500	492
CR-U110AC2L	1SVR405621R7100	446	OBROC2000-24VDC	1SNA645551R0600	492
CR-U110AC3	1SVR405622R7000	446	OBROC2000-24VUC	1SNA645525R2400	492
CR-U110AC3L	1SVR405622R7100	447	OBROC2000-446-60VUC	1SNA645553R0000	492
CR-U110DC2	1SVR405621R8000	446	OBROC2000-5-12VDC	1SNA645550R1100	492
CR-U110DC2L	1SVR405621R8100	446	OBROC5000-230VUC	1SNA645559R1600	492
CR-U110DC2LD	1SVR405621R8400	447	OBROC5000-24VDC	1SNA645524R2300	492
CR-U110DC3	1SVR405622R8000	446	RB101R-24VUC	1SNA645019R0400	484
CR-U110DC3L	1SVR405622R8100	447	RB111-115VUC	1SNA645016R2100	484
CR-U110DC3LD	1SVR405622R8400	447	RB111-230VUC	1SNA645017R2200	484
CR-U120AC2	1SVR405621R2000	446	RB111-24VUC	1SNA645014R2700	484
CR-U120AC2L	1SVR405621R2100	446	RB111R-24VUC	1SNA645018R0300	484
CR-U120AC3	1SVR405622R2000	446	RB121-115VUC	1SNA645003R0500	484
CR-U120AC3L	1SVR405622R2100	447	RB121-12VDC	1SNA645073R0000	484
CR-U125DC3	1SVR405622R8200	446	RB121-230VUC	1SNA645004R0400	484
CR-U220DC2	1SVR405621R9000	446	RB121-24VDC	1SNA645071R0000	484
CR-U220DC2L	1SVR405621R9100	446	RB121-24VUC	1SNA645001R0300	484
CR-U220DC3	1SVR405622R9000	446	RB121-446-60VUC	1SNA645002R0400	484
CR-U220DC3L	1SVR405622R9100	447	RB121-60-230VUC	1SNA645020R0100	485
CR-U230AC2	1SVR405621R3000	446	RB121G-115VUC	1SNA645007R0100	485
CR-U230AC2L	1SVR405621R3100	446	RB121G-12VDC	1SNA645075R0000	485
CR-U230AC3	1SVR405622R3000	446	RB121G-230VUC	1SNA645008R1200	485
CR-U230AC3L	1SVR405622R3100	447	RB121G-24VDC	1SNA645072R0000	485
CR-U2S	1SVR405670R0000	447	RB121G-24VUC	1SNA645005R0700	485
CR-U2SM	1SVR405670R1100	447	RB121G-446-60VUC	1SNA645006R0000	485
CR-U3E	1SVR405660R0100	447	RB121P-12VDC	1SNA645035R2400	484
CR-U3S	1SVR405660R0000	447	RB121P-5VDC	1SNA645034R2300	484
CR-U3SM	1SVR405660R1100	447	RB121PG-5VDC	1SNA645036R2500	485
CR-UH	1SVR405669R0000	447	RB121R-115VUC	1SNA645046R0700	485
OBIC0100-115-230	1SNA645022R2700	492	RB121R-230VUC	1SNA645011R2400	485
OBIC0100-24VDC	1SNA645021R2600	492	RB122G-115VUC	1SNA645041R0200	485
OBIC0100-446-60VUC	1SNA645049R1200	492	RB122G-230VUC	1SNA645013R2600	485
OBIC0100-5-12VDC	1SNA645047R0000	492	RB122G-24VUC	1SNA645012R2500	485
OBOA1000-115VUC	1SNA645062R0700	492	RB122G-446-60VUC	1SNA645040R1500	485

Index

Interface relays and optocouplers

Product type

Type	Order code	Page
RB-JB10	1SVR406570R0000	485
RB-JB20	1SVR406580R0000	485
RBR101R-24VUC	1SNA645519R0600	484
RBR111-24VUC	1SNA645514R2100	484
RBR111R-24VUC	1SNA645518R0500	484
RBR121-115VUC	1SNA645503R0700	484
RBR121-230VUC	1SNA645504R0000	484
RBR121-24VDC	1SNA645571R0000	484
RBR121-24VUC	1SNA645501R0500	484
RBR121-446-60VUC	1SNA645502R0600	484
RBR121-60-230VUC	1SNA645520R0300	485
RBR121G-115VUC	1SNA645507R0300	485
RBR121G-230VUC	1SNA645508R1400	485
RBR121G-24VDC	1SNA645572R0000	485
RBR121G-24VUC	1SNA645505R0100	485
RBR121G-446-60VUC	1SNA645506R0200	485
RBR121P-12VDC	1SNA645535R2600	484
RBR121P-5VDC	1SNA645534R2500	484
RBR121R-230VUC	1SNA645511R2600	485
RBR122G-115VUC	1SNA645541R0400	485
RBR122G-230VUC	1SNA645513R2000	485
RBR122G-24VUC	1SNA645512R2700	485
RBR122G-446-60VUC	1SNA645540R1700	485
SC612	1SNA290474R0200	485

Index

Interface relays and optocouplers

Order code

Order code	Type	Page	Order code	Type	Page
1SNA290474R0200	SC612	485	1SNA645508R1400	RBR121G-230VUC	485
1SNA645001R0300	RB121-24VUC	484	1SNA645511R2600	RBR121R-230VUC	485
1SNA645002R0400	RB121-446-60VUC	484	1SNA645512R2700	RBR122G-24VUC	485
1SNA645003R0500	RB121-115VUC	484	1SNA645513R2000	RBR122G-230VUC	485
1SNA645004R0400	RB121-230VUC	484	1SNA645514R2100	RBR111-24VUC	484
1SNA645005R0700	RB121G-24VUC	485	1SNA645518R0500	RBR111R-24VUC	484
1SNA645006R0000	RB121G-446-60VUC	485	1SNA645519R0600	RBR101R-24VUC	484
1SNA645007R0100	RB121G-115VUC	485	1SNA645520R0300	RBR121-60-230VUC	485
1SNA645008R1200	RB121G-230VUC	485	1SNA645521R2000	OBRIC0100-24VDC	492
1SNA645011R2400	RB121R-230VUC	485	1SNA645522R2100	OBRIC0100-115-230	492
1SNA645012R2500	RB122G-24VUC	485	1SNA645524R2300	OBROC5000-24VDC	492
1SNA645013R2600	RB122G-230VUC	485	1SNA645525R2400	OBROC2000-24VUC	492
1SNA645014R2700	RB111-24VUC	484	1SNA645526R2500	OBROC2000-230VUC	492
1SNA645016R2100	RB111-115VUC	484	1SNA645527R2600	OBROA1000-24VDC	492
1SNA645017R2200	RB111-230VUC	484	1SNA645529R0000	OBROA2000-24VDC	485
1SNA645018R0300	RB111R-24VUC	484	1SNA645534R2500	RBR121P-5VDC	484
1SNA645019R0400	RB101R-24VUC	484	1SNA645535R2600	RBR121P-12VDC	484
1SNA645020R0100	RB121-60-230VUC	485	1SNA645540R1700	RBR122G-446-60VUC	485
1SNA645021R2600	OBIC0100-24VDC	492	1SNA645541R0400	RBR122G-115VUC	485
1SNA645022R2700	OBIC0100-115-230	492	1SNA645547R0200	OBRIC0100-5-12VDC	492
1SNA645024R2100	OBOC5000-24VDC	492	1SNA645549R1400	OBRIC0100-446-60VUC	492
1SNA645025R2200	OBOC2000-24VUC	492	1SNA645550R1100	OBROC2000-5-12VDC	492
1SNA645026R2300	OBOC2000-230VUC	492	1SNA645551R0600	OBROC2000-24VDC	492
1SNA645027R2400	OBOA1000-24VDC	492	1SNA645553R0000	OBROC2000-446-60VUC	492
1SNA645028R0500	OBOA1000-230VUC	492	1SNA645559R1600	OBROC5000-230VUC	492
1SNA645029R0600	OBOA2000-24VDC	485	1SNA645571R0000	RBR121-24VDC	484
1SNA645034R2300	RB121P-5VDC	484	1SNA645572R0000	RBR121G-24VDC	485
1SNA645035R2400	RB121P-12VDC	484	1SVR405501R1010	CR-S005VDC1R	429
1SNA645036R2500	RB121PG-5VDC	485	1SVR405501R1020	CR-S005VDC1RG	429
1SNA645040R1500	RB122G-446-60VUC	485	1SVR405501R2010	CR-S012VDC1R	429
1SNA645041R0200	RB122G-115VUC	485	1SVR405501R2020	CR-S012VDC1RG	429
1SNA645046R0700	RB121R-115VUC	485	1SVR405501R3010	CR-S024VDC1R	429
1SNA645047R0000	OBIC0100-5-12VDC	492	1SVR405501R3020	CR-S024VDC1RG	429
1SNA645049R1200	OBIC0100-446-60VUC	492	1SVR405501R4010	CR-S048VDC1R	429
1SNA645050R1700	OBOC2000-5-12VDC	492	1SVR405501R4020	CR-S048VDC1RG	429
1SNA645051R0400	OBOC2000-24VDC	492	1SVR405501R5010	CR-S060VDC1R	429
1SNA645053R0600	OBOC2000-446-60VUC	492	1SVR405501R5020	CR-S060VDC1RG	429
1SNA645054R0700	OBOC2000-115VUC	492	1SVR405510R3050	CR-S024VDC1TRA	429
1SNA645058R1300	OBOC5000-115VUC	492	1SVR405510R3060	CR-S024VDC1MOS	429
1SNA645062R0700	OBOA1000-115VUC	492	1SVR405510R3070	CR-S024VDC1TRI	429
1SNA645071R0000	RB121-24VDC	484	1SVR405521R1100	CR-S006/024VDC1SS	430
1SNA645072R0000	RB121G-24VDC	485	1SVR405521R1200	CR-S006/024VDC1SZ	430
1SNA645073R0000	RB121-12VDC	484	1SVR405521R3100	CR-S012/024VADC1SS	430
1SNA645075R0000	RB121G-12VDC	485	1SVR405521R3200	CR-S012/024VADC1SZ	430
1SNA645501R0500	RBR121-24VUC	484	1SVR405521R5100	CR-S048/060VADC1SS	430
1SNA645502R0600	RBR121-446-60VUC	484	1SVR405521R5200	CR-S048/060VADC1SZ	430
1SNA645503R0700	RBR121-115VUC	484	1SVR405521R6100	CR-S110/125VADC1SS	430
1SNA645504R0000	RBR121-230VUC	484	1SVR405521R6200	CR-S110/125VADC1SZ	430
1SNA645505R0100	RBR121G-24VUC	485	1SVR405521R7100	CR-S220/240VADC1SS	430
1SNA645506R0200	RBR121G-446-60VUC	485	1SVR405521R7200	CR-S220/240VADC1SZ	430
1SNA645507R0300	RBR121G-115VUC	485	1SVR405541R3110	CR-S024VADC1CRS	429

Index

Interface relays and optocouplers

Order code

Order code	Type	Page	Order code	Type	Page
1SVR405541R3120	CR-S024VADC1CRGS	429	1SVR405601R6000	CR-P048DC2	433
1SVR405541R3210	CR-S024VADC1CRZ	429	1SVR405601R7000	CR-P110AC2	433
1SVR405541R3220	CR-S024VADC1CRGZ	429	1SVR405601R8000	CR-P110DC2	433
1SVR405541R6110	CR-S110VADC1CRS	429	1SVR405601R8010	CR-P110DC2SS42CV	436
1SVR405541R6120	CR-S110VADC1CRGS	429	1SVR405606R0000	CR-P024AC2G	433
1SVR405541R6210	CR-S110VADC1CRZ	429	1SVR405606R1000	CR-P024DC2G	433
1SVR405541R6220	CR-S110VADC1CRGZ	429	1SVR405606R1010	CR-P024DC2GLC42V	436
1SVR405541R7110	CR-S230VADC1CRS	429	1SVR405606R1011	CR-P024DC2GLC62CV	436
1SVR405541R7120	CR-S230VADC1CRGS	429	1SVR405606R1013	CR-P024DC2GLC62C	436
1SVR405541R7210	CR-S230VADC1CRZ	429	1SVR405606R3000	CR-P230AC2G	433
1SVR405541R7220	CR-S230VADC1CRGZ	429	1SVR405606R3010	CR-P230AC2GLC92CV	436
1SVR405598R0700	CR-SJB20-BLUE	430	1SVR405606R3012	CR-P230AC2GLC92C	436
1SVR405598R0800	CR-SJB20-RED	430	1SVR405606R3013	CR-P230AC2GLC92	436
1SVR405598R0900	CR-SJB20-BLACK	430	1SVR405606R7000	CR-P110AC2G	433
1SVR405599R0000	CR-SSEP	430	1SVR405610R4060	CR-P024MOS1	433
1SVR405600R0000	CR-P024AC1	433	1SVR405610R4070	CR-P024TRI1	433
1SVR405600R0010	CR-P024AC1SS62CV	412	1SVR405611R0000	CR-M024AC2	437
1SVR405600R1000	CR-P024DC1	433	1SVR405611R0100	CR-M024AC2L	438
1SVR405600R1010	CR-P024DC1SS42V	412	1SVR405611R0300	CR-M012AC2L	438
1SVR405600R1011	CR-P024DC1LC42V	412	1SVR405611R1000	CR-M024DC2	437
1SVR405600R1013	CR-P024DC1LC62C	412	1SVR405611R1100	CR-M024DC2L	438
1SVR405600R2000	CR-P120AC1	433	1SVR405611R1400	CR-M024DC2LD	439
1SVR405600R2010	CR-P120AC1SS92CV	412	1SVR405611R2000	CR-M120AC2	437
1SVR405600R3000	CR-P230AC1	433	1SVR405611R2100	CR-M120AC2L	438
1SVR405600R3010	CR-P230AC1LC92CV	412	1SVR405611R3000	CR-M230AC2	437
1SVR405600R3011	CR-P230AC1LS	412	1SVR405611R3100	CR-M230AC2L	438
1SVR405600R3110	CR-P230AC1SS92CV	412	1SVR405611R4000	CR-M012DC2	437
1SVR405600R4000	CR-P012DC1	433	1SVR405611R4100	CR-M012DC2L	438
1SVR405600R4010	CR-P012DC1SS42V	412	1SVR405611R4200	CR-M060DC2	437
1SVR405600R5000	CR-P048AC1	433	1SVR405611R4300	CR-M060DC2L	438
1SVR405600R6000	CR-P048DC1	433	1SVR405611R4400	CR-M012DC2LD	439
1SVR405600R7000	CR-P110AC1	433	1SVR405611R5000	CR-M048AC2	437
1SVR405600R8000	CR-P110DC1	433	1SVR405611R5100	CR-M048AC2L	438
1SVR405600R8010	CR-P110DC1SS42CV	412	1SVR405611R6000	CR-M048DC2	437
1SVR405601R0000	CR-P024AC2	433	1SVR405611R6100	CR-M048DC2L	438
1SVR405601R0010	CR-P024AC2SS62CV	436	1SVR405611R6400	CR-M048DC2LD	439
1SVR405601R0200	CR-P012AC2	433	1SVR405611R7000	CR-M110AC2	437
1SVR405601R1000	CR-P024DC2	433	1SVR405611R7100	CR-M110AC2L	438
1SVR405601R1010	CR-P024DC2SS42V	436	1SVR405611R8000	CR-M110DC2	437
1SVR405601R1011	CR-P024DC2LS42V	436	1SVR405611R8100	CR-M110DC2L	438
1SVR405601R1012	CR-P024DC2LC42	436	1SVR405611R8200	CR-M125DC2	437
1SVR405601R1013	CR-P024DC2LS42	436	1SVR405611R8300	CR-M125DC2L	438
1SVR405601R2000	CR-P120AC2	433	1SVR405611R8400	CR-M110DC2LD	439
1SVR405601R2010	CR-P120AC2SS92CV	436	1SVR405611R8500	CR-M125DC2LD	439
1SVR405601R3000	CR-P230AC2	433	1SVR405611R9000	CR-M220DC2	437
1SVR405601R3011	CR-P230AC2LS92CV	436	1SVR405611R9100	CR-M220DC2L	438
1SVR405601R3012	CR-P230AC2LC92	436	1SVR405611R9400	CR-M220DC2LD	439
1SVR405601R3110	CR-P230AC2SS92CV	436	1SVR405612R0000	CR-M024AC3	437
1SVR405601R4000	CR-P012DC2	433	1SVR405612R0100	CR-M024AC3L	438
1SVR405601R4010	CR-P012DC2SS42V	436	1SVR405612R0300	CR-M012AC3L	438
1SVR405601R5000	CR-P048AC2	433	1SVR405612R1000	CR-M024DC3	437

Index

Interface relays and optocouplers

Order code

Order code	Type	Page	Order code	Type	Page
1SVR405612R1100	CR-M024DC3L	438	1SVR405613R6000	CR-M048DC4	437
1SVR405612R1400	CR-M024DC3LD	439	1SVR405613R6100	CR-M048DC4L	438
1SVR405612R2000	CR-M120AC3	437	1SVR405613R6400	CR-M048DC4LD	439
1SVR405612R2100	CR-M120AC3L	438	1SVR405613R7000	CR-M110AC4	437
1SVR405612R3000	CR-M230AC3	437	1SVR405613R7100	CR-M110AC4L	438
1SVR405612R3100	CR-M230AC3L	438	1SVR405613R8000	CR-M110DC4	437
1SVR405612R4000	CR-M012DC3	437	1SVR405613R8100	CR-M110DC4L	438
1SVR405612R4100	CR-M012DC3L	438	1SVR405613R8200	CR-M125DC4	437
1SVR405612R4200	CR-M060DC3	437	1SVR405613R8300	CR-M125DC4L	438
1SVR405612R4300	CR-M060DC3L	438	1SVR405613R8400	CR-M110DC4LD	439
1SVR405612R4400	CR-M012DC3LD	439	1SVR405613R8500	CR-M125DC4LD	439
1SVR405612R5000	CR-M048AC3	437	1SVR405613R9000	CR-M220DC4	437
1SVR405612R5100	CR-M048AC3L	438	1SVR405613R9100	CR-M220DC4L	438
1SVR405612R5200	CR-M060AC3	437	1SVR405613R9400	CR-M220DC4LD	439
1SVR405612R6000	CR-M048DC3	437	1SVR405614R1100	CR-M024DC4LD	439
1SVR405612R6100	CR-M048DC3L	438	1SVR405618R0000	CR-M024AC4G	439
1SVR405612R6400	CR-M048DC3LD	439	1SVR405618R0100	CR-M024AC4LG	440
1SVR405612R7000	CR-M110AC3	437	1SVR405618R1000	CR-M024DC4G	439
1SVR405612R7100	CR-M110AC3L	438	1SVR405618R1010	CR-M024DC4GLC62CV	420
1SVR405612R8000	CR-M110DC3	437	1SVR405618R1011	CR-M024DC4GSS42V	420
1SVR405612R8100	CR-M110DC3L	438	1SVR405618R1100	CR-M024DC4LG	440
1SVR405612R8200	CR-M125DC3	437	1SVR405618R1110	CR-M024DC4LGLC22	420
1SVR405612R8300	CR-M125DC3L	438	1SVR405618R1400	CR-M024DC4LDG	440
1SVR405612R8400	CR-M110DC3LD	439	1SVR405618R1410	CR-M024DC4LDGSS	420
1SVR405612R8500	CR-M125DC3LD	439	1SVR405618R2100	CR-M120AC4LG	440
1SVR405612R9000	CR-M220DC3	437	1SVR405618R3000	CR-M230AC4G	439
1SVR405612R9100	CR-M220DC3L	438	1SVR405618R3100	CR-M230AC4LG	440
1SVR405612R9400	CR-M220DC3LD	439	1SVR405618R3110	CR-M230AC4LGLC	421
1SVR405613R0000	CR-M024AC4	437	1SVR405618R3111	CR-M230AC4LGSS	421
1SVR405613R0010	CR-M024AC4LS62CV	420	1SVR405618R3112	CR-M230AC4GSS92CV	421
1SVR405613R0100	CR-M024AC4L	438	1SVR405618R4100	CR-M012DC4LG	440
1SVR405613R0300	CR-M012AC4L	438	1SVR405618R4300	CR-M060DC4LG	440
1SVR405613R1000	CR-M024DC4	437	1SVR405618R4400	CR-M012DC4LDG	440
1SVR405613R1010	CR-M024DC4SS42V	420	1SVR405618R4410	CR-M012DC4LDGSS	420
1SVR405613R1011	CR-M024DC4LS42V	420	1SVR405618R5100	CR-M048AC4LG	440
1SVR405613R1012	CR-M024DC4LC42	420	1SVR405618R6100	CR-M048DC4LG	440
1SVR405613R1100	CR-M024DC4L	438	1SVR405618R7000	CR-M110AC4G	439
1SVR405613R2000	CR-M120AC4	437	1SVR405618R7100	CR-M110AC4LG	440
1SVR405613R2100	CR-M120AC4L	438	1SVR405618R8100	CR-M110DC4LG	440
1SVR405613R3000	CR-M230AC4	437	1SVR405618R8300	CR-M125DC4LG	440
1SVR405613R3011	CR-M230AC4LS92CV	421	1SVR405618R9100	CR-M220DC4LG	440
1SVR405613R3012	CR-M230AC4LC92	421	1SVR405621R0000	CR-U024AC2	446
1SVR405613R3100	CR-M230AC4L	438	1SVR405621R0100	CR-U024AC2L	446
1SVR405613R3110	CR-M230AC4SS92CV	421	1SVR405621R0300	CR-U012AC2L	446
1SVR405613R4000	CR-M012DC4	437	1SVR405621R1000	CR-U024DC2	446
1SVR405613R4100	CR-M012DC4L	438	1SVR405621R1100	CR-U024DC2L	446
1SVR405613R4200	CR-M060DC4	437	1SVR405621R1400	CR-U024DC2LD	447
1SVR405613R4300	CR-M060DC4L	438	1SVR405621R2000	CR-U120AC2	446
1SVR405613R4400	CR-M012DC4LD	439	1SVR405621R2100	CR-U120AC2L	446
1SVR405613R5000	CR-M048AC4	437	1SVR405621R3000	CR-U230AC2	446
1SVR405613R5100	CR-M048AC4L	438	1SVR405621R3100	CR-U230AC2L	446

Index

Interface relays and optocouplers

Order code

Order code	Type	Page	Order code	Type	Page
1SVR405621R4000	CR-U012DC2	446	1SVR405651R2000	CR-M3SS	420
1SVR405621R4100	CR-U012DC2L	446	1SVR405651R2100	CR-M3LS	420
1SVR405621R4400	CR-U012DC2LD	447	1SVR405651R3000	CR-M4SS	420
1SVR405621R5000	CR-U048AC2	446	1SVR405651R3100	CR-M4LS	420
1SVR405621R5100	CR-U048AC2L	446	1SVR405651R3200	CR-M4LC	420
1SVR405621R6000	CR-U048DC2	446	1SVR405651R3300	CR-M4SF	420
1SVR405621R6100	CR-U048DC2L	446	1SVR405651R4100	CR-M2LSH	420
1SVR405621R6400	CR-U048DC2LD	447	1SVR405651R5100	CR-M3LSH	420
1SVR405621R7000	CR-U110AC2	446	1SVR405652R0000	CR-P/M 42	421
1SVR405621R7100	CR-U110AC2L	446	1SVR405652R1000	CR-P/M 42 V	421
1SVR405621R8000	CR-U110DC2	446	1SVR405652R4000	CR-P/M 42 B	421
1SVR405621R8100	CR-U110DC2L	446	1SVR405652R4100	CR-P/M 42 BV	421
1SVR405621R8400	CR-U110DC2LD	447	1SVR405652R9000	CR-P/M 42 C	421
1SVR405621R9000	CR-U220DC2	446	1SVR405652R9100	CR-P/M 42 CV	421
1SVR405621R9100	CR-U220DC2L	446	1SVR405653R0000	CR-P/M 52B	421
1SVR405622R0000	CR-U024AC3	446	1SVR405653R1000	CR-P/M 52C	421
1SVR405622R0100	CR-U024AC3L	447	1SVR405653R4000	CR-P/M 52D	421
1SVR405622R0300	CR-U012AC3L	447	1SVR405654R0000	CR-P/M 62	421
1SVR405622R1000	CR-U024DC3	446	1SVR405654R0100	CR-P/M 92	421
1SVR405622R1100	CR-U024DC3L	447	1SVR405654R1000	CR-P/M 62 V	421
1SVR405622R2000	CR-U120AC3	446	1SVR405654R1100	CR-P/M 92 V	421
1SVR405622R2100	CR-U120AC3L	447	1SVR405654R4000	CR-P/M 62 E	421
1SVR405622R3000	CR-U230AC3	446	1SVR405654R4100	CR-P/M 62 EV	421
1SVR405622R3100	CR-U230AC3L	447	1SVR405655R0000	CR-P/M 62 C	422
1SVR405622R4000	CR-U012DC3	446	1SVR405655R0100	CR-P/M 92 C	422
1SVR405622R4100	CR-U012DC3L	447	1SVR405655R1000	CR-P/M 62 CV	422
1SVR405622R4400	CR-U012DC3LD	447	1SVR405655R1100	CR-P/M 92 CV	422
1SVR405622R5000	CR-U048AC3	446	1SVR405655R4000	CR-P/M 62 D	422
1SVR405622R5100	CR-U048AC3L	447	1SVR405655R4100	CR-P/M 62 DV	422
1SVR405622R5200	CR-U060AC3	446	1SVR405656R0000	CR-P/M 72	422
1SVR405622R6000	CR-U048DC3	446	1SVR405656R1000	CR-P/M 72 A	422
1SVR405622R6100	CR-U048DC3L	447	1SVR405656R2000	CR-P/M 82	422
1SVR405622R6400	CR-U048DC3LD	447	1SVR405658R0000	CR-PM	413
1SVR405622R7000	CR-U110AC3	446	1SVR405658R1000	CR-MM	420
1SVR405622R7100	CR-U110AC3L	447	1SVR405658R2000	CR-MP	420
1SVR405622R8000	CR-U110DC3	446	1SVR405658R5000	CR-PJ	413
1SVR405622R8100	CR-U110DC3L	447	1SVR405658R6000	CR-MJ	420
1SVR405622R8200	CR-U125DC3	446	1SVR405659R0000	CR-PH	413
1SVR405622R8400	CR-U110DC3LD	447	1SVR405659R0100	CR-PH1	413
1SVR405622R9000	CR-U220DC3	446	1SVR405659R1000	CR-MH	420
1SVR405622R9100	CR-U220DC3L	447	1SVR405659R1100	CR-MH1	420
1SVR405623R1100	CR-U024DC3LD	447	1SVR405660R0000	CR-U3S	447
1SVR405650R0000	CR-PLS	413	1SVR405660R0100	CR-U3E	447
1SVR405650R0100	CR-PLSX	413	1SVR405660R1100	CR-U3SM	447
1SVR405650R0200	CR-PLC	413	1SVR405661R0000	CR-U 21	424
1SVR405650R1000	CR-PSS	413	1SVR405662R0000	CR-U 41	424
1SVR405651R0000	CR-P/M 22	421	1SVR405662R1000	CR-U 41V	424
1SVR405651R1000	CR-M2SS	420	1SVR405662R4000	CR-U 41B	424
1SVR405651R1100	CR-M2LS	420	1SVR405662R4100	CR-U 41BV	424
1SVR405651R1200	CR-M2LC	420	1SVR405662R9000	CR-U 41C	424
1SVR405651R1300	CR-M2SF	420	1SVR405662R9100	CR-U 41CV	424

Index

Interface relays and optocouplers

Order code

Order code	Type	Page
1SVR405663R0000	CR-U 51B	424
1SVR405663R1000	CR-U 51C	424
1SVR405663R4000	CR-U 51D	424
1SVR405664R0000	CR-U 61	424
1SVR405664R0100	CR-U 91	424
1SVR405664R1000	CR-U 61V	424
1SVR405664R1100	CR-U 91V	424
1SVR405664R4000	CR-U 61E	424
1SVR405664R4100	CR-U 61EV	424
1SVR405665R0000	CR-U 61C	424
1SVR405665R0100	CR-U 91C	424
1SVR405665R1000	CR-U 61CV	424
1SVR405665R1100	CR-U 91CV	424
1SVR405665R4000	CR-U 61D	424
1SVR405665R4100	CR-U 61DV	424
1SVR405666R0000	CR-U 71	424
1SVR405666R1000	CR-U 71A	424
1SVR405666R2000	CR-U 81	424
1SVR405667R0000	CR-U T	424
1SVR405669R0000	CR-UH	447
1SVR405670R0000	CR-U2S	447
1SVR405670R1100	CR-U2SM	447
1SVR406570R0000	RB-JB10	485
1SVR406580R0000	RB-JB20	485

ABB STOTZ-KONTAKT GmbH

Eppelheimer Strasse 82
69123 Heidelberg
Germany

**You can find the address of your local
sales organization on the ABB homepage**



abb.com/lowvoltage

We reserve the right to make technical changes or modify the contents of this document without prior notice. With regard to purchase orders, the agreed particulars shall prevail. ABB AG does not accept any responsibility whatsoever for potential errors or possible lack of information in this document.

We reserve all rights in this document and in the subject matter and illustrations contained therein. Any reproduction, disclosure to third parties or utilization of its contents – in whole or in parts – is forbidden without prior written consent of ABB AG Copyright© 2022 ABB AG All rights reserved