

SBR1045 thru SBR10200

Schottky Barrier Rectifiers

Reverse Voltage 45 to 100V Forward Current 10A

FEATURES

- * Plastic package has Underwriters Laboratory Flammability Classification 94V-0
- * Low power loss, high efficiency
- * For use in low voltage high frequency inverters, free wheeling, and polarity protection applications
- * Guardring for over voltage protection
- * High temperature soldering guaranteed: 260°C/10 seconds at terminals

Mechanical Data

Case: JEDEC TO-277A,
molded plastic over SKY body
Terminals: Plated leads, solderable per
MIL-STD-750, Method 2026
Mounting Position: Any
Weight: 0.108 g
Handling precaution: None

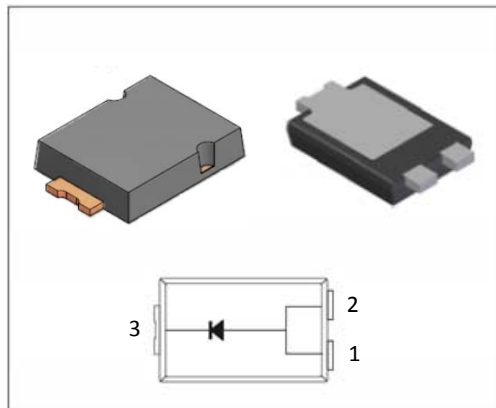

We declare that the material of product is Halogen free (green epoxy compound)

1. Electrical Characteristic

Maximum & Thermal Characteristics Ratings at 25°C ambient temperature unless otherwise specified.

Parameter Symbol	symbol	SBR1045	SBR1060	SBR10100	SBR10150	SBR10200	Unit
device marking code		SBR1045	SBR1060	SBR10100	SBR10150	SBR10200	
Maximum repetitive peak reverse voltage	V_{RRM}	45	60	100	150	200	V
Maximum RMS voltage	V_{RMS}	31.5	42	70	105	140	V
Maximum DC blocking voltage	V_{DC}	45	60	100	150	200	V
Maximum average forward rectified current at $T_c = 75^\circ\text{C}$	$I_{F(AV)}$	10.0					A
Peak forward surge current 8.3ms single half sine-wave superimposed on rated load (JEDEC Method)	I_{FSM}	300					A
Typical thermal resistance (Note 1)	$R_{\theta JC}$	8					°C/W
	$R_{\theta JL}$	15					
	$R_{\theta JA}$	31					
Typical thermal resistance (Note 2)	$R_{\theta JA}$	60					°C/W
Operating junction temperature range	T_J	-55 to +150					°C
Storage temperature range	T_{STG}	-55 to +150					°C

Electrical Characteristics Ratings at 25°C ambient temperature unless otherwise specified.

Parameter Symbol	symbol	SBR1045	SBR1060	SBR10100	SBR10150	SBR10200	Unit
Maximum instantaneous forward voltage at 25°C at 5A at 10A	V_F	-	-	0.82			V
		0.55	0.70	0.88			
Maximum DC reverse current $T_A = 25^\circ\text{C}$ at rated DC blocking voltage $T_j = 100^\circ\text{C}$	IR	0.3			15.0		mA
		15.0			500		
Typical junction capacitance at 4.0V, 1MHz	CJ	500					PF

NOTES:

1. Polyimide PCB, 2oz. Copper. Cathode pad dimensions 18.8mm x 14.4mm. Anode pad dimensions 5.6mm x 14.4mm.
2. FR-4 PCB, 2oz. Copper.

SBR1045 thru SBR10200

2. Ratings and Characteristic Curves (TA = 25°C unless otherwise noted)

Fig. 1 - Forward Current Derating Curve

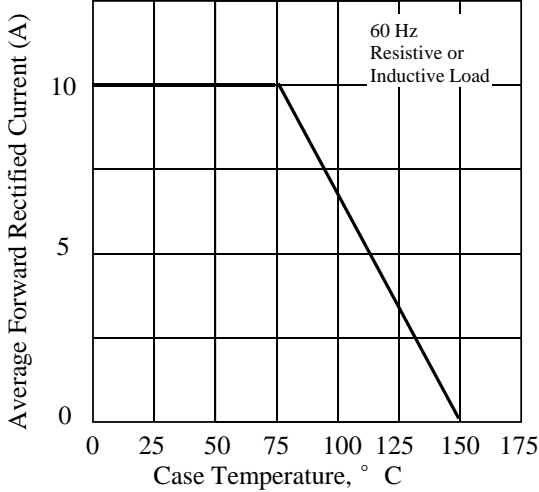

Fig. 2 - Maximum Non-repetitive Peak Forward Surge Current

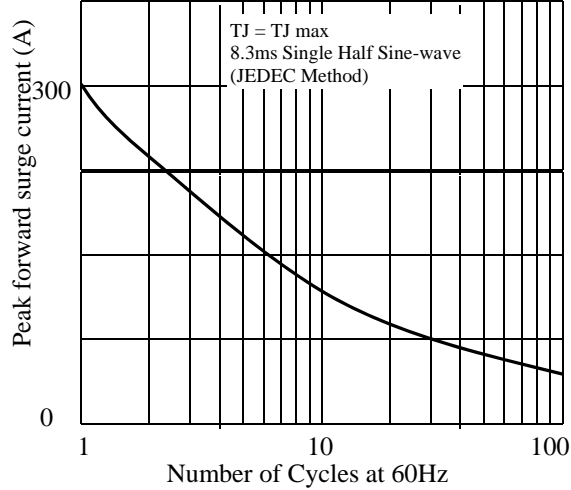

Fig. 3 - Typical Instantaneous Forward Characteristics

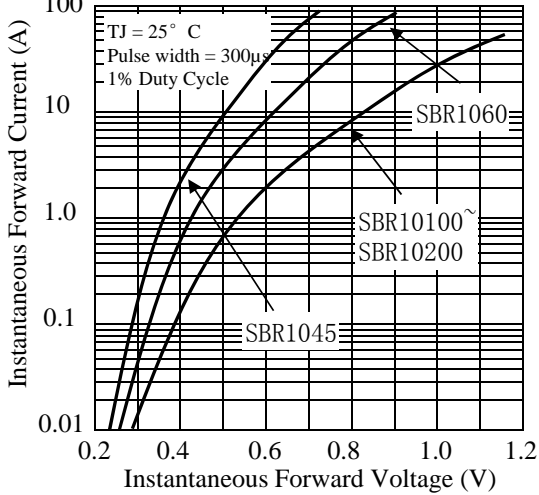

Fig. 4 - Typical Reverse Characteristics

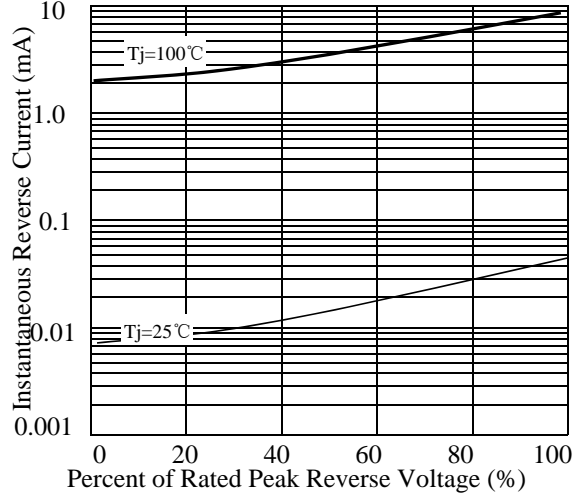

Fig. 5 - typical transient thermal impedance (Note 2)

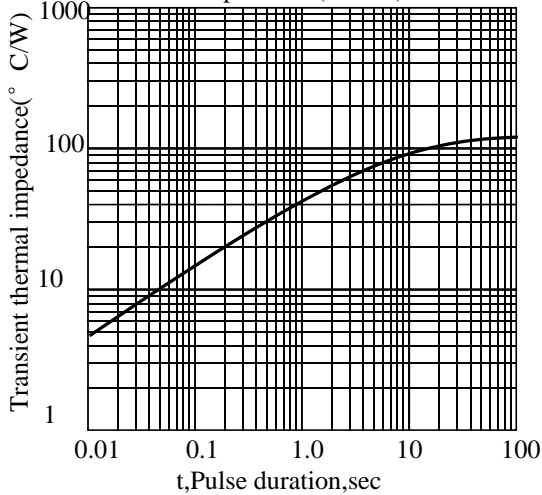
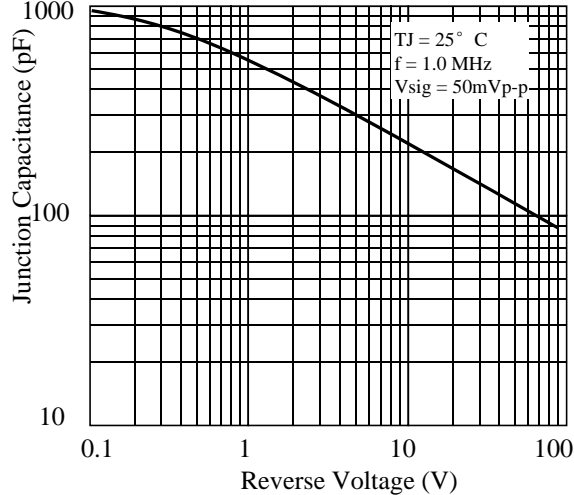

Fig. 6 - Typical Junction Capacitance



SBR1045 thru SBR10200

3. dimension:

TO-277A

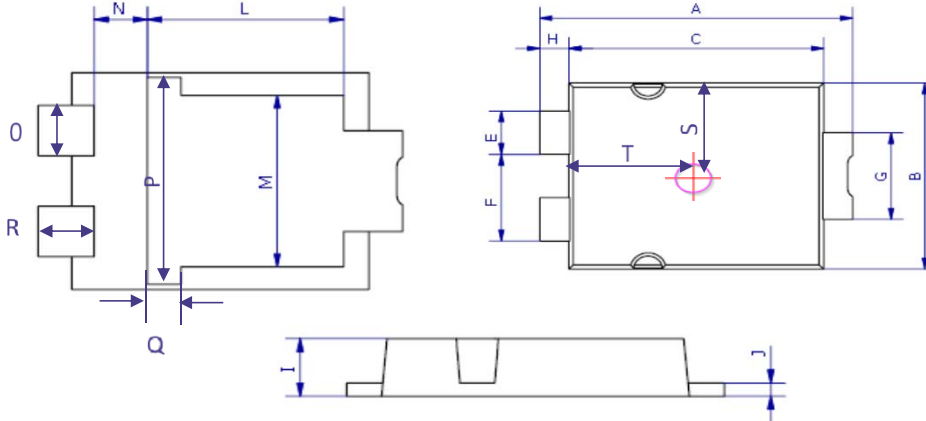

DIM	MILLIMETERS		INCHES	
	MIN	MAX	MIN	MAX
A	6.3	6.7	0.248	0.264
B	4.1	4.5	0.161	0.177
C	5.1	5.5	0.201	0.217
E	0.9	1.1	0.035	0.043
F	1.9	2.1	0.075	0.083
G	1.9	2.1	0.075	0.083
H	0.50	0.70	0.020	0.028
I	1.00	1.20	0.039	0.047
J	0.15	0.35	0.006	0.014
L	3.30	3.70	0.130	0.146
M	3.20	3.60	0.126	0.142
N	0.80	1.10	0.033	0.043
O	0.90	1.10	0.035	0.043
P	3.90	4.30	0.154	0.169
Q	0.50	0.80	0.020	0.031
R	0.85	1.15	0.033	0.045
S	2.00	2.30	0.079	0.091
T	2.50	2.80	0.098	0.110

Mounting PAD layout

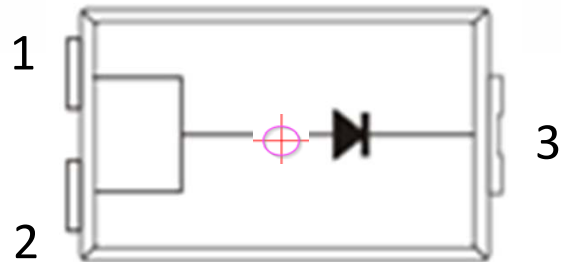
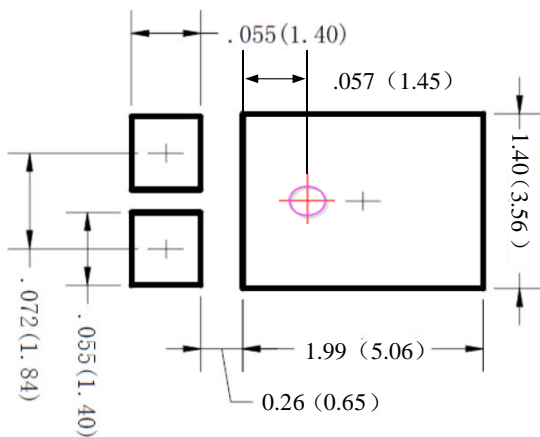

- 1: Anode
- 2: Anode
- 3: Cathode

SBR1045 thru SBR10200

4. Update Record

版次	更新记录	更新作者	更新日期
1	第一版	周杰	2013-8-7
2	更新产品尺寸为T0-277A	周杰	2014-1-17
3	标注外形尺寸公差	周杰	2014-6-9
4	增加SBR1060 SBR10100 SBR10200	周杰	2014-7-31
5	修正管体L标注尺寸	周杰	2014-9-26
6	增加SBR10150	周杰	2015-9-28
7	增加PIN标示说明	谭志伟	2016-10-8
8	增加包装说明	谭志伟	2016-10-13
9	增加尺寸标注	谭志伟	2017-7-26