

UV Enhanced Series

Inversion Layers and Planar Diffused Silicon Photodiodes

OSI Optoelectronics offers two distinct families of UV enhanced silicon photodiodes. Inversion channel series and planar diffused series. Both families of devices are especially designed for low noise detection in the UV region of electromagnetic spectrum.

Inversion layer structure UV enhanced photodiodes exhibit 100% internal quantum efficiency and are well suited for low intensity light measurements. They have high shunt resistance, low noise and high breakdown voltages. The response uniformity across the surface and quantum efficiency improves with 5 to 10 volts applied reverse bias. In photovoltaic mode (unbiased), the capacitance is higher than diffused devices but decreases rapidly with an applied reverse bias. Photocurrent non-linearity sets in at lower photocurrents for inversion layer devices compared to the diffused ones. Below 700nm, their responsivities vary little with temperature.

Planar diffused structure (UV-D Series) UV enhanced photodiodes show significant advantages over inversion layer devices, such as lower capacitance and higher response time. These devices exhibit linearity of photocurrent up to higher light input power compared to inversion layer devices.

They have relatively lower responsivities and quantum efficiencies compared to inversion layer devices. There are two types of planar diffused UV enhanced photodiodes available: UVD and UVE. Both series have almost similar electro-optical characteristics, except in the UVE series, where the near IR responses of the devices are suppressed. This is especially desirable if blocking the near IR region of the spectrum is necessary. UVD devices peak at 970 nm and UVE devices at 720 nm (see graph). Both series may be biased for lower capacitance, faster response and wider dynamic range. Or they may be operated in the photovoltaic (unbiased) mode for applications requiring low drift with temperature variations. The UVE devices have a higher shunt resistance than their counterparts of UVD devices, but have a higher capacitance.

These detectors are ideal for coupling to an OP-AMP in the current mode configuration as shown below.



APPLICATIONS

- Pollution Monitoring
- Medical Instrumentation
- UV Exposure Meters
- Spectroscopy
- Water Purification
- Fluorescence

FEATURES

- Inversion series:
 - 100% Internal QE
- Ultra High R_{SH}
- Planar Diffused Series:
 - IR Suppressed
 - High Speed Response
 - High Stability
- Excellent UV response

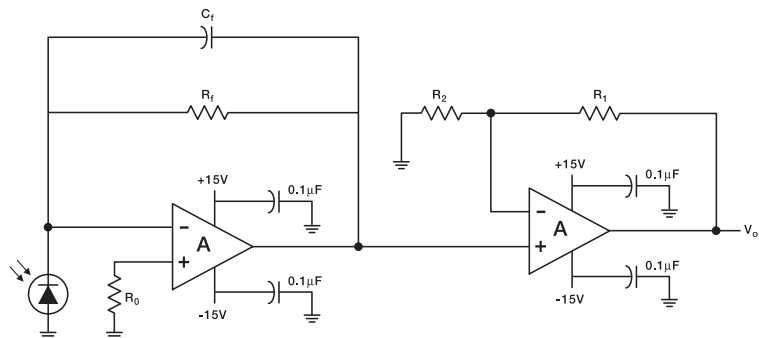

Inversion Layer UV Enhanced Photodiodes

Typical Electro-Optical Specifications at T_A=23°C

Model Number	Active Area		Responsivity (A/W)		Capacitance (pF)	Shunt Resistance (MΩ)		NEP (W/√Hz)	Reverse Voltage (V)	Rise Time (μs)	Operating Current (mA)	Temp.* Range (°C)		Package Style ¶
	Area (mm²)	Dimensions (mm)	254 nm		0 V	-10 mV		0V 254 nm		0 V 254 nm 50 Ω	0 V	Operating	Storage	
			min.	typ.	max.	min.	typ.	typ.		max.	typ.			

'UV Enhanced' Series, Inversion Layer, Metal Package §

UV-001	0.8	1.0 φ	0.09	0.14	60	250	500	6.4 e-14	5	0.2	0.1	-20 ~ +60	-55 ~ +80	5 / TO-5
UV-005	5.1	2.54 φ			300	80	200	1.0 e-13		0.9				
UV-015	15	3.05 x 3.81			800	30	100	1.4 e-13		2.0				
UV-20	20	5.08 φ			1000	25	50	2.0 e-13		2.0				
UV-35	35	6.60 x 5.33			1600	20	30	1.7 e-13		3.0		-10 ~ +60	-20 ~ +70	
UV-50	50	7.87 φ			2500	10	20	2.6 e-13		3.5				
UV-50L †					100	11.28 φ	4500	5		10		4.5 e-13	5.9	
UV-100	11 / BNC													
UV-100L	10 / Lo-Prof													

'UV Enhanced' Series, Inversion Layer, Plastic Package §

FIL-UV005	5.1	2.54 φ	0.09	0.14	300	50	100	9.2 e-14	5	0.9	0.1	-10 ~ +60	-20 ~ +70	14 / Plastic
FIL-UV20	20	5.08 φ			1000	20	50	1.3 e-13		2.0				25 / Plastic
UV-35P	35	6.60 x 5.33			1600	15	30	1.7 e-13		3.0				15 / Plastic
FIL-UV50	50	7.87 φ			2500	10	20	2.1 e-13		3.5				
FIL-UV100	100	11.28 φ			4500	5	10	2.9 e-13		5.9				

Model Number	Active Area		Responsivity (A/W)		Capacitance (pF)	Shunt Resistance (GΩ)		NEP (W/√Hz)	Reverse Voltage (V)	Rise Time (μs)	Dark Current (pA)	Temp.* Range (°C)		Package Style ¶
	Area (mm²)	Dimensions (mm)	254 nm		0 V	-10 mV		0V 254 nm		0 V 254 nm 1kΩ	V _r =10mV	Operating	Storage	
			min.	typ.	max.	min.	typ.	typ.		max.	typ.			

'7' Series, Super UV

OSD1.2-7U	1.2	1.1 sq	0.08	0.10	40	0.5	5.0	1.5 e-14	5	0.1	2	-25 ~ +70	-40 ~ +100	7 / TO-18
OSD1.2-7Q	1.2	1.1 sq	0.10	0.12	40	0.5	5.0	1.5 e-14		0.1	2			7 / TO-18
OSD5.8-7U	5.8	2.4 sq	0.08	0.10	180	0.5	3.0	2.0 e-14		0.4	3			5 / TO-5
OSD5.8-7Q	5.8	2.4 sq	0.10	0.12	180	0.5	3.0	2.0 e-14		0.4	3			5 / TO-5
OSD35-7Q	33.6	5.8 sq	0.10	0.12	1000	0.1	0.5	6.0 e-14		2.0	20			3 / TO-8
OSD35-7CO	33.6	5.8 sq	0.11	0.13	1000	0.1	0.5	6.0 e-14		2.0	20			25 / Ceramic

† The 'l' or 'L' suffix on the model number is indicative of the photodiode chip being isolated from the package by an additional pin connected to the case.

§ The photodiode chips in "FIL" series are isolated in a low profile plastic package. They have a large field of view as well as in line pins.

¶ For mechanical drawings please refer to pages 58 thru 69.

* Non-Condensing temperature and Storage Range, Non-Condensing Environment.

Typical Spectral Response

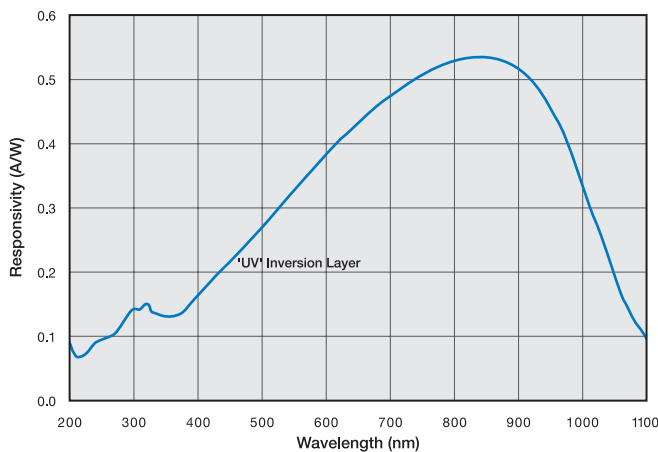

Typical Shunt Resistance vs. Temperature

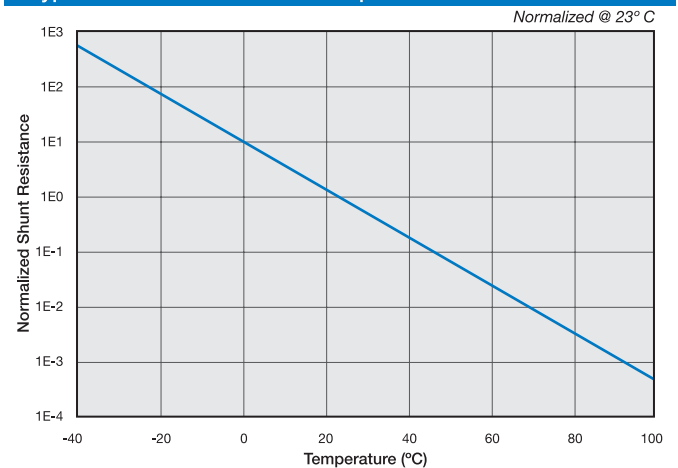

Planar Diffused UV Enhanced Photodiodes

Typical Electro-Optical Specifications at $T_A=23^\circ\text{C}$

Model Number	Active Area		Peak Wavelength λ_p (nm)	Responsivity (A/W)			Capacitance (pF)		Shunt Resistance (G Ω)		NEP (W/ $\sqrt{\text{Hz}}$)	Reverse Voltage (V)	Rise Time (μs)	Temp.* Range ($^\circ\text{C}$)		Package Style ¶
	Area (mm ²)	Dimension (mm)		254 nm	633 nm	930 nm	0 V	-10 mV		0V 254 nm	0 V 254 nm 50 Ω		Operating	Storage		
				typ.	typ.	typ.	typ.	min.	typ.	typ.	max.				typ.	
'UVD' Series Planar Diffused, Metal Package																
UV-005D	5.7	2.4 sq	970	0.10	0.33	0.50	100	0.30	4	2.0 e -14	5	0.10	-20 ~ +60	-55 ~ +80	5 / TO-5	
UV-013D	13	3.6 sq					225	0.20	2	2.8 e -14		0.20				
UV-035D	34	5.8 sq					550	0.10	0.50	5.6 e -14		0.40				6 / TO-8
'UVD' Series Planar Diffused, Ceramic Package																
UV-005DC	5.7	2.4 sq	970	0.10	0.33	0.50	100	0.30	4	2.0 e -14	5	0.10	-20 ~ +60	-20 ~ +80	25 / Ceramic	
UV-035DC	34	5.8 sq					550	0.10	0.5	5.6 e -14		0.20				
UV-100DC	100	10 sq					1750	0.04	0.20	9.1 e -14		1.00				
'UVE' Series Planar Diffused, Metal Package																
UV-005E	5.7	2.4 sq	720	0.10	0.33	0.17	200	0.50	10	1.3 e -14	5	0.15	-20 ~ +60	-55 ~ +80	5 / TO-5	
UV-013E	13	3.6 sq					400	0.40	5	1.8 e -14		0.30				
UV-035E	34	5.8 sq					1000	0.20	1	4.1 e -14		0.80				6 / TO-8
'UVE' Series Planar Diffused, Ceramic Package																
UV-005EC	5.7	2.4 sq	720	0.10	0.33	0.17	200	0.50	10	1.3 e -15	5	0.15	-20 ~ +60	-20 ~ +80	25 / Ceramic	
UV-035EC	34	5.8 sq					1000	0.20	1	4.1 e -14		0.80				
UV-100EC	100	10 sq					2500	0.10	0.50	5.8 e -14		1.00				

¶ For mechanical specifications please refer to pages 58 thru 69.

* Non-Condensing temperature and Storage Range, Non-Condensing Environment.

Typical Spectral Response

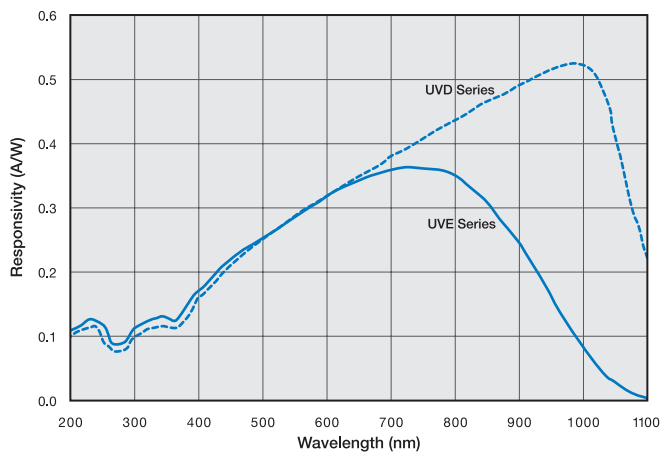

Typical Capacitance vs. Reverse Bias

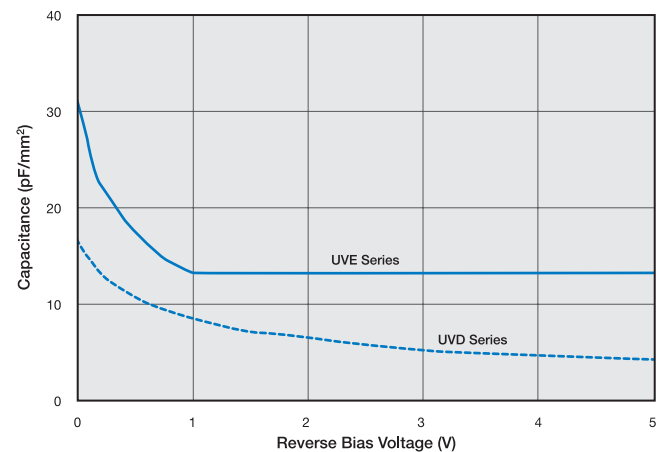

1. Parameter Definitions:

A = Distance from top of chip to top of glass.

a = Photodiode Anode.

B = Distance from top of glass to bottom of case.

c = Photodiode Cathode

(Note: cathode is common to case in metal package products unless otherwise noted).

W = Window Diameter.

F.O.V. = Field of View (see definition below).

2. Dimensions are in inches (1 inch = 25.4 mm).

3. Pin diameters are 0.018 ± 0.002" unless otherwise specified.

4. Tolerances (unless otherwise noted)

General: 0.XX ±0.01"

0.XXX ±0.005"

Chip Centering: ±0.010"

Dimension 'A': ±0.015"

5. Windows

All '**UV**' Enhanced products are provided with QUARTZ glass windows, 0.027 ± 0.002" thick.

All '**XUV**' products are provided with removable windows.

All '**DLS**' PSD products are provided with A/R coated glass windows.

All '**FIL**' photoconductive and photovoltaic products are epoxy filled instead of glass windows.

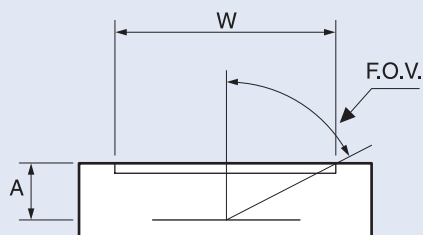

$$F.O.V. = \tan^{-1} \left(\frac{W}{2A} \right)$$



For Further Assistance
Please Call One of Our Experienced
Sales and Applications Engineers

310-978-0516



- Or -
On the Internet at

www.osioptoelectronics.com

Mechanical Specifications

All units in inches. Pinouts are bottom view.

1 TO-18	2 TO-5	3 TO-8																																		
<p>Products:</p> <p>PIN-020A PIN-040A PIN-040-DP/SB</p> <p>Pin Circle Dia.=0.100</p> <table border="1"> <thead> <tr> <th>P/N</th> <th>A</th> <th>B</th> <th>W</th> </tr> </thead> <tbody> <tr> <td>PIN-020A</td> <td>0.075</td> <td>0.200</td> <td>0.155</td> </tr> <tr> <td>PIN-040A</td> <td>0.075</td> <td>0.200</td> <td>0.155</td> </tr> </tbody> </table>	P/N	A	B	W	PIN-020A	0.075	0.200	0.155	PIN-040A	0.075	0.200	0.155	<p>Products:</p> <p>PIN-5DI PIN-5DPI PIN-13DI PIN-13DPI PIN-5-YAG CD-25T</p> <p>Pin Circle Dia.=0.200</p> <table border="1"> <thead> <tr> <th>P/N</th> <th>A</th> <th>B</th> <th>W</th> </tr> </thead> <tbody> <tr> <td>All Others</td> <td>0.094</td> <td>0.180</td> <td>0.240</td> </tr> <tr> <td>CD-25T</td> <td>0.050</td> <td>0.130</td> <td>0.23</td> </tr> </tbody> </table>	P/N	A	B	W	All Others	0.094	0.180	0.240	CD-25T	0.050	0.130	0.23	<p>Products:</p> <p>PIN-6DI PIN-6DPI PIN-44DI PIN-44DPI OSD35-0 OSD35-7Q</p> <p>Pin Circle Dia.=0.295</p> <table border="1"> <thead> <tr> <th>P/N</th> <th>A</th> </tr> </thead> <tbody> <tr> <td>PIN-6DI/6DPI</td> <td>0.115</td> </tr> <tr> <td>PIN-44DI/44DPI</td> <td>0.125</td> </tr> <tr> <td>OSD35-0</td> <td>0.130</td> </tr> <tr> <td>OSD35-7Q</td> <td>0.130 Quartz Window</td> </tr> </tbody> </table>	P/N	A	PIN-6DI/6DPI	0.115	PIN-44DI/44DPI	0.125	OSD35-0	0.130	OSD35-7Q	0.130 Quartz Window
P/N	A	B	W																																	
PIN-020A	0.075	0.200	0.155																																	
PIN-040A	0.075	0.200	0.155																																	
P/N	A	B	W																																	
All Others	0.094	0.180	0.240																																	
CD-25T	0.050	0.130	0.23																																	
P/N	A																																			
PIN-6DI/6DPI	0.115																																			
PIN-44DI/44DPI	0.125																																			
OSD35-0	0.130																																			
OSD35-7Q	0.130 Quartz Window																																			
<p>Products:</p> <p>PIN-2DI PIN-2DPI PIN-3CDP PIN-3CDPI BPX-65R</p> <p>Pin Circle Dia.=0.100</p> <table border="1"> <thead> <tr> <th>P/N</th> <th>A</th> <th>B</th> </tr> </thead> <tbody> <tr> <td>BPX-65R</td> <td>0.070</td> <td>0.200</td> </tr> <tr> <td>All Others</td> <td>0.090</td> <td>0.150</td> </tr> </tbody> </table>	P/N	A	B	BPX-65R	0.070	0.200	All Others	0.090	0.150	<p>Products:</p> <p>PIN-5D PIN-5DP PIN-5DP/SB PIN-13D PIN-13DP PIN-005E-550F UV-001 UV-005 UV-005D UV-005E UV-013D UV-013E UV-015 OSD-5-0 OSD15-0 OSD5-5T OSD15-5T OSD5.8-7Q OSD5.8-7U</p> <p>Pin Circle Dia.=0.200</p> <table border="1"> <thead> <tr> <th>P/N</th> <th>A</th> <th>B</th> </tr> </thead> <tbody> <tr> <td>OSD-Prefix Devices</td> <td>0.050</td> <td>0.130</td> </tr> <tr> <td>All Others</td> <td>0.102</td> <td>0.180</td> </tr> </tbody> </table> <p>Quartz Window: OSD5.8-7Q UV Transmissive Window: OSD5.8-7U</p>	P/N	A	B	OSD-Prefix Devices	0.050	0.130	All Others	0.102	0.180	<p>Products:</p> <p>PIN-6D PIN-6DP PIN-44D PIN-44DP UV-020 UV-035D UV-035E UV-035</p> <p>Pin Circle Dia.=0.295</p>																
P/N	A	B																																		
BPX-65R	0.070	0.200																																		
All Others	0.090	0.150																																		
P/N	A	B																																		
OSD-Prefix Devices	0.050	0.130																																		
All Others	0.102	0.180																																		
<p>Products:</p> <p>PIN-3CD PIN-3CDP BPX-65 OSD1-0 OSD1-5T OSD3-5T OSD1.2-7Q OSD1.2-7U</p> <p>Pin Circle Dia.=0.100</p> <table border="1"> <thead> <tr> <th>P/N</th> <th>A</th> <th>B</th> </tr> </thead> <tbody> <tr> <td>PIN-3CD / 3CDP</td> <td>0.087</td> <td>0.146</td> </tr> <tr> <td>BPX-65</td> <td>0.075</td> <td>0.200</td> </tr> <tr> <td>OSD-Prefix Devices</td> <td>0.080</td> <td>0.200</td> </tr> </tbody> </table> <p>Quartz Window: OSD1.2-7Q UV Transmissive Window: OSD1.2-7U</p>	P/N	A	B	PIN-3CD / 3CDP	0.087	0.146	BPX-65	0.075	0.200	OSD-Prefix Devices	0.080	0.200	<p>Products:</p> <p>PIN-125DPL</p> <p>Pin Circle Dia.=0.100</p>	<p>Products:</p> <p>PIN-HR005 PIN-HR008 PIN-HR020 PIN-HR026 PIN-HR040</p> <p>Pin Circle Dia.=0.100</p>																						
P/N	A	B																																		
PIN-3CD / 3CDP	0.087	0.146																																		
BPX-65	0.075	0.200																																		
OSD-Prefix Devices	0.080	0.200																																		

All units in inches. Pinouts are bottom view.

Low Profile

Products:
 PIN-10DI
 PIN-10DPI
 PIN-10DPI/SB
 UV-50L
 UV-100L

Pin Circle Dia.=0.73

BNC

Products:
 PIN-10D
 PIN-10DP
 PIN-10DP/SB
 UV-50
 UV-100

Outer Contact — Anode	PIN-10D, PIN-10DP, PIN-10DP/SB
Outer Contact — Cathode	UV-50, UV-100

BNC

Products:
 PIN-25D
 PIN-25DP

Outer Contact — Anode

Special BNC

Products:
 PIN-10AP
 PIN-10DF

P/N	A	B	C
PIN-10DF	0.217	0.330	1.020
PIN-10AP	0.386	0.550	1.415

Special Plastic

Products:
 FIL-5C
 FIL-20C
 FIL-UV20
 FIL-C4DG

P/N	A	B
FIL-5C FIL-20C	0.060	0.130
FIL-UV005 FIL-UV20 FIL-C4DG	0.087	0.152

P/N	1	2	3	4	5	6
FIL-5C FIL-20C FIL-UV005	a	-	c	a	-	c
FIL-UV20	c	-	a	c	-	a
FIL-C4DG	c	a	c	c	a	c

Special Plastic

Products:
 FIL-44C
 FIL-100C
 FIL-UV50
 FIL-UV100
 FIL-C10DG

P/N	A	B
FIL-44C FIL-100C	0.052	0.130
FIL-UV50 FIL-UV100 FIL-C10DG	0.090	0.155

P/N	1	2	3	4	5	6	7	8
FIL-44C FIL-100C	a	-	-	c	a	-	-	c
FIL-UV50 FIL-UV100	c	-	-	a	c	-	-	a
FIL-C10DG	c	a	a	c	c	a	a	c

All units in inches. Pinouts are bottom view.

22 TO-5

Products:

XUV-005

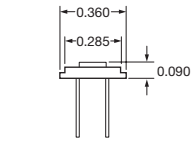

Pin Circle Dia.=0.200



23 TO-8

Products:

XUV-020
XUV-035

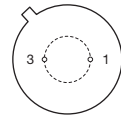
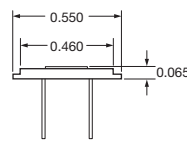

Pin Circle Dia.=0.295



24 TO-8

Products:

PIN-DSIn-TEC

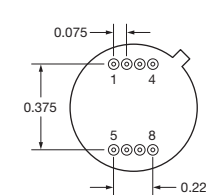
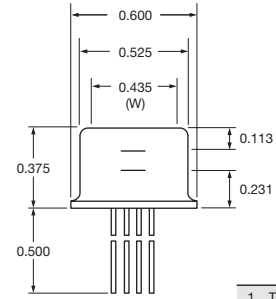

Pinout

- 1 TEC (-)
- 2 Thermistor
- 3 Thermistor
- 4 TEC (+)
- 5 Bottom InGaAs, Cathode
- 6 Bottom InGaAs, Anode
- 7 Top Silicon, Anode
- 8 Top Silicon, Cathode

25 Special Ceramic / Plastic

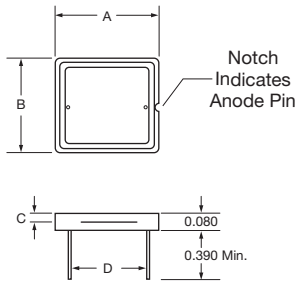

P/N	Dimensions			
	A	B	C	D
UV-005EC	0.400	0.350	0.030	0.280
UV-035EC	0.400	0.350	0.030	0.290
UV-100EC	0.650	0.590	0.048	0.500
UV-005DC	0.400	0.350	0.030	0.280
UV-035DC	0.400	0.350	0.030	0.290
UV-100DC	0.650	0.590	0.053	0.500
XUV-50C	0.650	0.590	0.027	0.490
XUV-100C	0.650	0.590	0.027	0.490
RD-100	0.650	0.590	0.027	0.490
RD-100A	0.650	0.590	0.027	0.490
UV-35P	0.390	0.345	0.050	0.275
OSD35-7CO	0.390	0.350	---	0.290
OSD35-LR-A	0.390	0.350	---	0.290
OSD35-LR-D	0.390	0.350	---	0.290

Note: OSD35-prefix packages come with 0.31" (min.) leads

26 TO-8

Products:

RD-100
RD-100A
UV-35P
UV-005EC
UV-035EC
UV-100EC
UV-005DC
UV-035DC
UV-100DC
XUV-50C
XUV-100C
OSD35-7CO
OSD35-LR-A
OSD35-LR-D

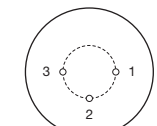
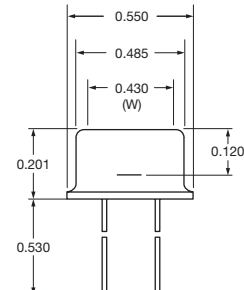

Pin Circle Dia.=0.295

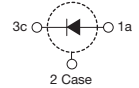

27 Special Plastic

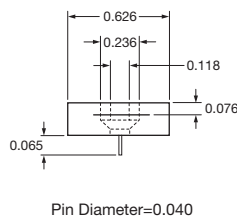
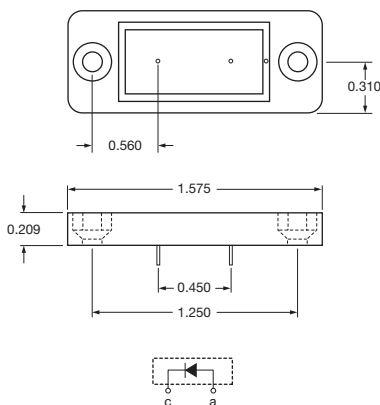

Pin Diameter=0.040



28 BNC

Products:

PIN-220D
PIN-220DP
PIN-220DP/SB

Products:

XUV-100

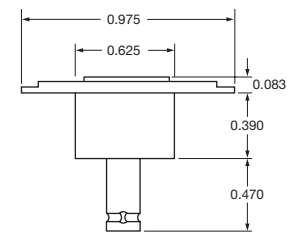

BNC Connector
Outer Contact = Cathode

UV-DQ SERIES

new 190 to 1100 nm Spectral Range

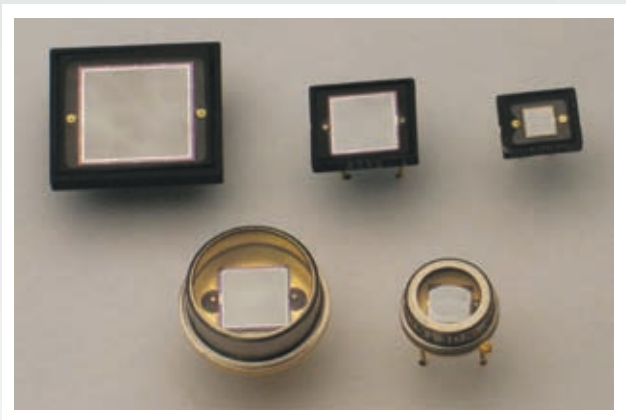

OSI optoelectronics introduces new family of Planar Diffused UV Enhanced Photodiode: the UV-DQ and UV-DQC Series. The new Silicon is processed for enhanced responsivity over 200-400nm and sensitivity down to 190nm. The DK series offer hermetic package alternative at a lower cost and is sensitive down to 320nm.

These detectors can be reverse biased for lower capacitance, faster response, and wider dynamic range applications. They are ideal for UV Spectrophotometer, Analytical Instruments, and Medical Instrumentation.

FEATURES

- Excellent UV Sensitivity
- Low Capacitance
- High Shunt Resistance

APPLICATIONS

- Spectrophotometer
- Analytical Instruments
- Medical Instrument



Typical Electro-Optical Specifications at T_A = 23° C

Model Number	Active Area		Peak Wavelength (nm)	Responsivity (A/W)			Capacitance (pF)	Shunt Resistance (GOhm)		NEP (W/√Hz)	Reverse Voltage (V)	Rise Time (us)		Temp. Range (°C)		Package Style
	Area (mm ²)	Dimension (mm)		200 nm	633 nm	980 nm		0V	-10mV			0V 1kOhm	Operating	Storage		
				typ.	typ.	typ.		typ.	min.						typ.	
Metal Package, Quartz Window																
UV-005DQ	5.7	2.4 x 2.4	980	0.12	0.33	0.5	65	0.3	1	3.6 E-14	5	0.2	-20 ~ +60	-55 ~ +80		2 / TO-5
UV-013DQ	13	3.6 x 3.6					150	0.2	0.8	4.1 E-14		0.5				2 / TO-5
UV-035DQ	34	5.8 x 5.8					380	0.1	0.4	5.8 E-14		1				3 / TO-8
UV-100DQ	100	10 x 10					1100	0.04	0.2	8.2 E-14		3				10 / BNC
Ceramic Package, Quartz Window																
UV-005DQC	5.7	2.4 x 2.4	980	0.12	0.33	0.5	65	0.3	1	3.6 E-14	5	0.2	-20 ~ +60	-20 ~ +80		4 / Ceramic
UV-035DQC	34	5.8 x 5.8					380	0.1	0.4	5.8 E-14		1				
UV-100DQC	100	10 x 10					1100	0.04	0.2	8.2 E-14		3				
Metal Package, Borosilicate Window¶																
UV-005DK	5.7	2.4 x 2.4	980	--	0.33	0.5	65	0.3	1	3.6 E-14*	5	0.2	-40 ~ +100	-55 ~ +125		2 / TO-5
UV-013DK	13	3.6 x 3.6					150	0.2	0.8	4.1 E-14*		0.5				2 / TO-5
UV-035DK	34	5.8 x 5.8					380	0.1	0.4	5.8 E-14*		1				3 / TO-8
UV-100DK	100	10 x 10					1100	0.04	0.2	8.2 E-14*		3				10 / BNC

*) NEP is calculated using typical responsivity 0.12 A/W at 320nm

¶) Sensitivity range: 320-1100 nm

No responsibility is assumed for inaccuracies or omission. OSI Optoelectronics Inc. reserves the right to change products and specifications.

UV-DQ SERIES

190 to 1100 nm Spectral Range

■ **Typ. Responsivity with Quartz Window ($T_A = 25^\circ\text{C}$)**

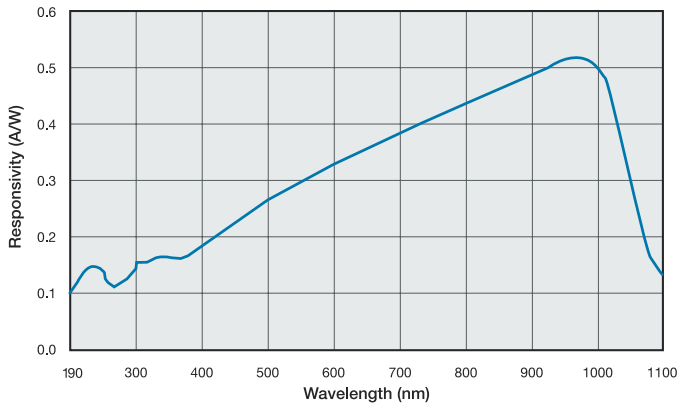

■ **Typ. Responsivity with Borosilicate Window ($T_A = 25^\circ\text{C}$)**

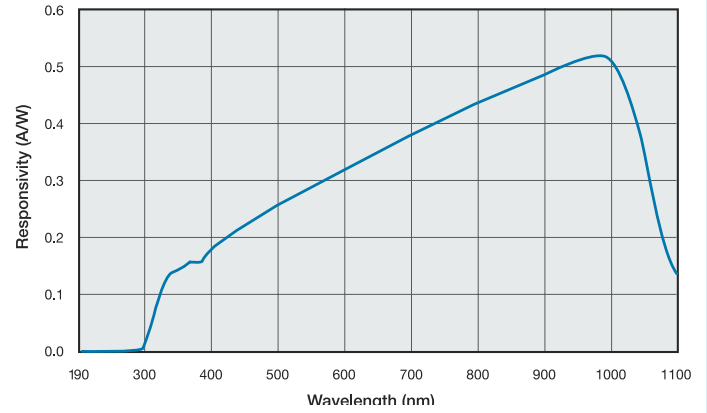

■ **Typ. Capacitance vs. Reverse Bias ($T_A = 25^\circ\text{C}$)**

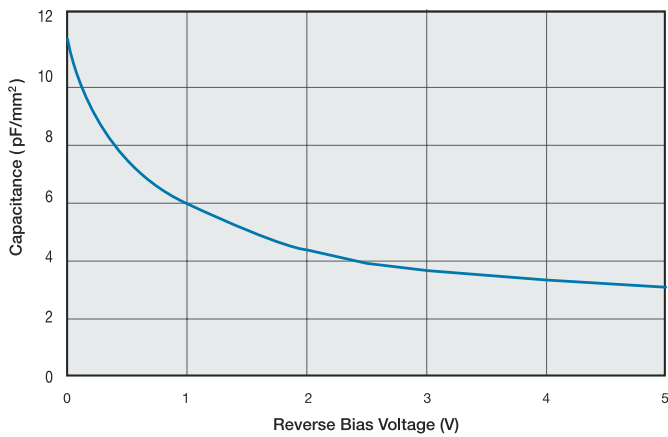

■ **Typ. Dark Current vs. Reverse Bias ($T_A = 25^\circ\text{C}$, Normalized at -0.01V)**

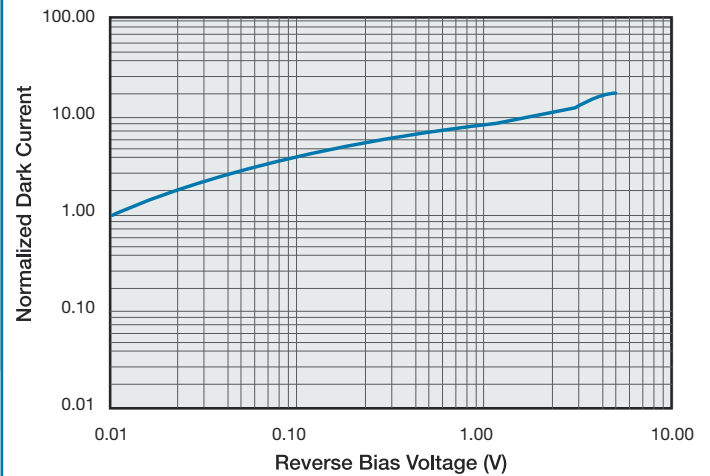

■ **Typ. Rise Time vs. Load Resistance ($T_A = 25^\circ\text{C}$, $V_R = 0\text{V}$)**

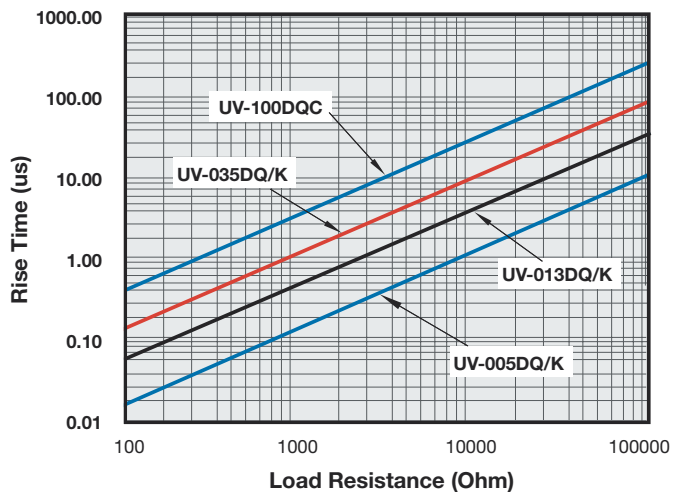

■ **Typ. Shunt Resistance vs. Ambient Temperature**

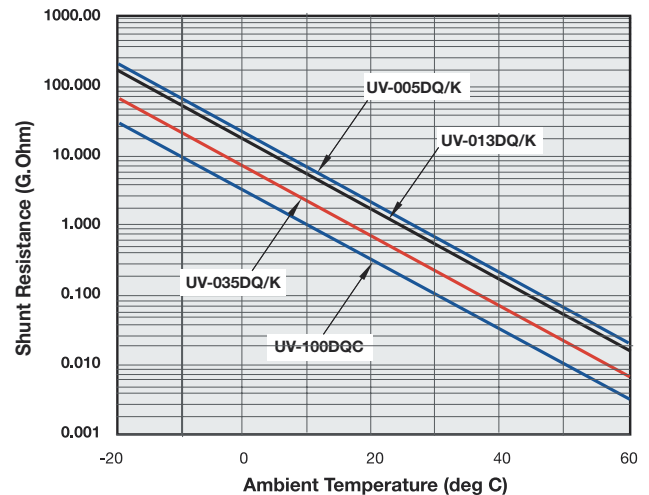

MECHANICAL SPECIFICATIONS

All units in inches. Pinouts are bottom view.

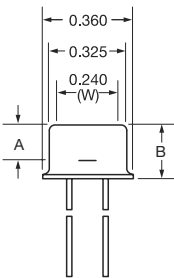
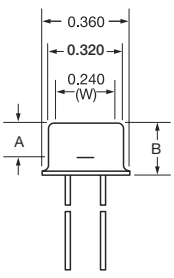
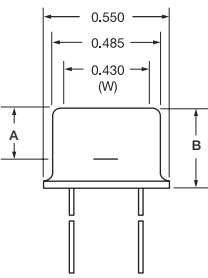
1 TO-5	2 TO-5	3 TO-8																								
 <p>Products: UV-001 UV-005 UV-015</p> <p>Pin Circle Dia.=0.200</p> <table border="1"> <thead> <tr> <th>Model #</th> <th>A</th> <th>B</th> </tr> </thead> <tbody> <tr> <td>UV-XXX</td> <td>0.102</td> <td>0.180</td> </tr> </tbody> </table>	Model #	A	B	UV-XXX	0.102	0.180	 <p>Products: UV-005DQ/K UV-013DQ/K UV-005EQ/K UV-013EQ/K</p> <p>Pin Circle Dia.=0.200</p> <table border="1"> <thead> <tr> <th>Model #</th> <th>A</th> <th>B</th> </tr> </thead> <tbody> <tr> <td>UV-xxxDQ/K</td> <td>0.065</td> <td>0.138</td> </tr> <tr> <td>UV-xxxEQ/K</td> <td>0.055</td> <td>0.138</td> </tr> </tbody> </table>	Model #	A	B	UV-xxxDQ/K	0.065	0.138	UV-xxxEQ/K	0.055	0.138	 <p>Products: UV-035DQ/K UV-035EQ/K</p> <p>Pin Circle Dia.=0.295</p> <table border="1"> <thead> <tr> <th>Model #</th> <th>A</th> <th>B</th> </tr> </thead> <tbody> <tr> <td>UV-035DQ/K</td> <td>0.130</td> <td>0.195</td> </tr> <tr> <td>UV-035EQ/K</td> <td>0.120</td> <td>0.195</td> </tr> </tbody> </table>	Model #	A	B	UV-035DQ/K	0.130	0.195	UV-035EQ/K	0.120	0.195
Model #	A	B																								
UV-XXX	0.102	0.180																								
Model #	A	B																								
UV-xxxDQ/K	0.065	0.138																								
UV-xxxEQ/K	0.055	0.138																								
Model #	A	B																								
UV-035DQ/K	0.130	0.195																								
UV-035EQ/K	0.120	0.195																								

4 Ceramic

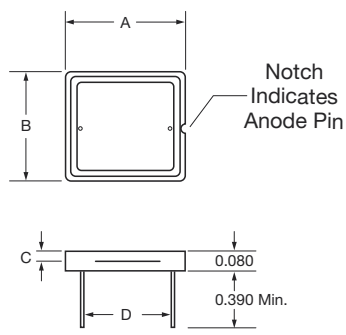

Notch Indicates Anode Pin

P/N	Dimensions			
	A	B	C	D
UV-005EQC	0.300	0.236	0.024	0.177
UV-035EQC	0.400	0.350	0.028	0.290
UV-100EQC	0.650	0.590	0.028	0.490
UV-005DQC	0.300	0.236	0.035	0.177
UV-035DQC	0.400	0.350	0.039	0.290
UV-100DQC	0.650	0.590	0.039	0.490
XUV-50C	0.650	0.590	0.027	0.490
XUV-100C	0.650	0.590	0.027	0.490

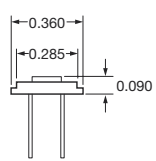
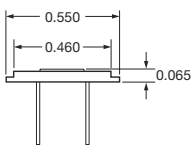
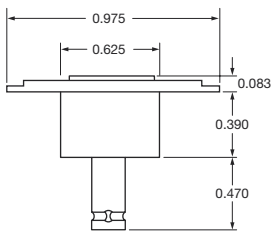
5 TO-5	6 TO-8	7 BNC
 <p>Products: XUV-005</p> <p>Pin Circle Dia.=0.200</p>	 <p>Products: XUV-020 XUV-035</p> <p>Pin Circle Dia.=0.295</p>	 <p>Products: XUV-100</p> <p>BNC Connector Outer Contact = Cathode</p>

MECHANICAL SPECIFICATIONS

All units in inches. Pinouts are bottom view.

8 TO-8

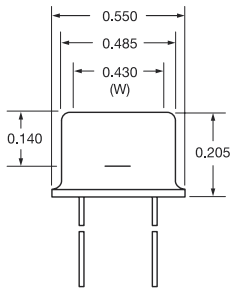

Products:
UV-020
UV-035

c: cathode and case

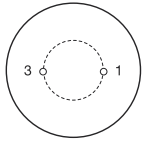
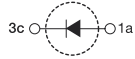

Pin Circle Dia.=0.295

9 Low Profile

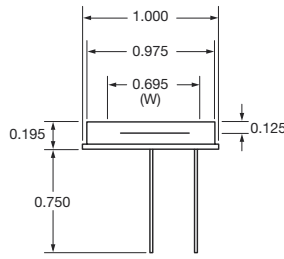

Products:
UV-50L
UV-100L

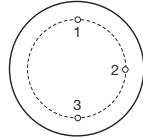

Pin Circle Dia.=0.73

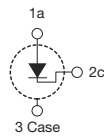

10 BNC

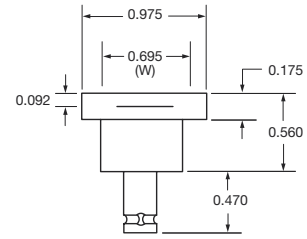

Products:
UV-100EQ/K
UV-100DQ/K
UV-50
UV-100

Outer Contact — Anode	UV-100EQ/K, UV-100DQ/K
Outer Contact — Cathode	UV-50, UV-100

11 Special Plastic

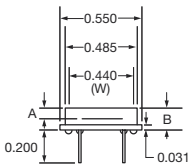

Products:
FIL-UV005
FIL-UV20

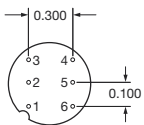

Dimensions

P/N	A	B
FIL-UV005	0.087	0.152
FIL-UV20		

Pinouts

P/N	1	2	3	4	5	6
FIL-UV005	a	-	c	a	-	c
FIL-UV20	c	-	a	c	-	a

12 Special Plastic

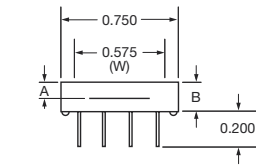

Products:
FIL-UV50
FIL-UV100

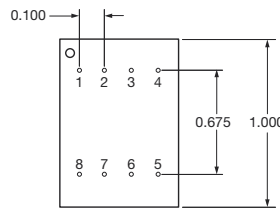

Dimensions

P/N	A	B
FIL-UV50	0.090	0.155
FIL-UV100		

Pinouts

P/N	1	2	3	4	5	6	7	8
FIL-UV50	c	-	-	a	c	-	-	a
FIL-UV100								

13 Special Plastic

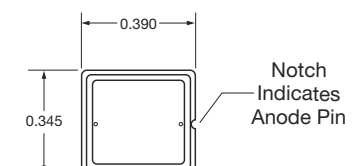

Products:
UV-35P

