

Automotive-Grade, Galvanically Isolated Current Sensor IC with Common-Mode Field Rejection in a Small-Footprint SOIC8 Package

FEATURES AND BENEFITS

- AEC-Q100 qualified
- Differential Hall sensing rejects common-mode fields
- 1.2 mΩ primary conductor resistance for low power loss and high inrush current withstand capability
- Integrated shield virtually eliminates capacitive coupling from current conductor to die, greatly suppressing output noise due to high dv/dt transients
- Industry-leading noise performance with greatly improved bandwidth through proprietary amplifier and filter design techniques
- High-bandwidth 120 kHz analog output for faster response times in control applications
- Filter pin allows user to filter the output for improved resolution at lower bandwidth
- Patented integrated digital temperature compensation circuitry allows for near closed loop accuracy over temperature in an open loop sensor
- Small-footprint, low-profile SOIC8 package suitable for space-constrained applications
- Filter pin simplifies bandwidth limiting for better resolution at lower frequencies

Continued on the next page...



CB Certificate Number:
US-32848-UL

PACKAGE: 8-Pin SOIC (suffix LC)

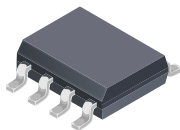

Not to scale

DESCRIPTION

The Allegro™ ACS724 current sensor IC is an economical and precise solution for AC or DC current sensing in industrial, automotive, commercial, and communications systems. The small package is ideal for space-constrained applications while also saving costs due to reduced board area. Typical applications include motor control, load detection and management, switched-mode power supplies, and overcurrent fault protection.

The device consists of a precise, low-offset, linear Hall sensor circuit with a copper conduction path located near the surface of the die. Applied current flowing through this copper conduction path generates a magnetic field which is sensed by the integrated Hall IC and converted into a proportional voltage. The current is sensed differentially in order to reject common-mode fields, improving accuracy in magnetically noisy environments. The inherent device accuracy is optimized through the close proximity of the magnetic field to the Hall transducer. A precise, proportional voltage is provided by the low-offset, chopper-stabilized BiCMOS Hall IC, which is programmed for accuracy after packaging. The output of the device has a positive slope when an increasing current flows through the primary copper conduction path (from pins 1 and 2, to pins 3 and 4), which is the path used for current sensing. The internal resistance of this conductive path is 1.2 mΩ typical, providing low power loss.

The terminals of the conductive path are electrically isolated from the sensor leads (pins 5 through 8). This allows the ACS724 current sensor IC to be used in high-side current sense applications without the use of high-side differential amplifiers or other costly isolation techniques.

Continued on the next page...

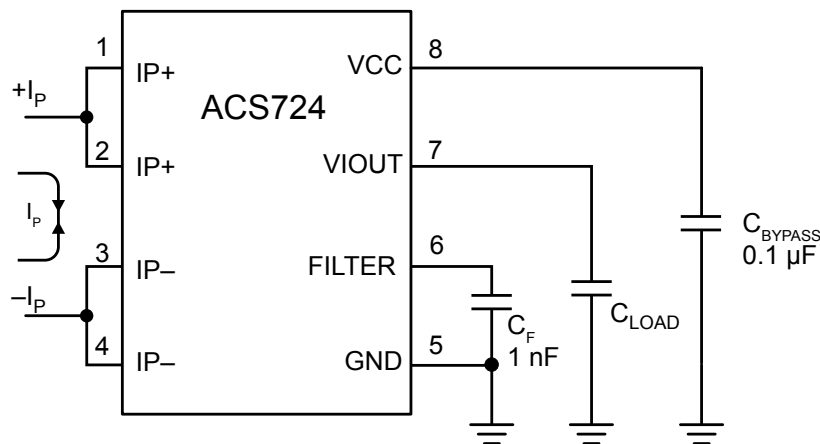

The ACS724 outputs an analog signal, V_{IOUT} , that changes proportionally with the bidirectional AC or DC primary sensed current, I_P , within the specified measurement range. The FILTER pin can be used to decrease the bandwidth in order to optimize the noise performance.

Typical Application

FEATURES AND BENEFITS (continued)

- 5 V, single supply operation
- Output voltage proportional to AC or DC current
- Factory-trimmed sensitivity and quiescent output voltage for improved accuracy
- Chopper stabilization results in extremely stable quiescent output voltage
- Nearly zero magnetic hysteresis
- Ratiometric output from supply voltage

DESCRIPTION (continued)

The ACS724 is provided in a small, low-profile surface-mount SOIC8 package. The leadframe is plated with 100% matte tin, which is compatible with standard lead (Pb) free printed circuit board assembly processes. Internally, the flip-chip device is considered Pb-free. However, the solder bump connections are available in a Pb-free or high-temperature Pb-based option. Part numbers followed by -S are manufactured with tin-silver-based solder bumps, making these parts Pb-free compliant without the use of RoHS exemptions. Part numbers followed by -T are manufactured with Pb-based solder bumps using allowed RoHS exemptions.

SELECTION GUIDE

Part Number	I_{PR} (A)	Sens(Typ) at $V_{CC} = 5\text{ V}$ (mV/A)	T_A (°C)	Packing
-S VARIANT [1]				
ACS724LLCTR-2P5AB-S	±2.5	800	-40 to 150	Tape and Reel, 3000 pieces per reel
ACS724LLCTR-05AU-S	5			
ACS724LLCTR-05AB-S	±5	400		
ACS724LLCTR-10AU-S	10			
ACS724LLCTR-10AB-S	±10	200		
ACS724LLCTR-20AU-S	20			
ACS724LLCTR-20AB-S	±20	100		
ACS724LLCTR-30AU-S	30	133		
ACS724LLCTR-30AB-S	±30	66		
ACS724LLCTR-50AB-S	±50	40		
-T VARIANT [2]				
ACS724LLCTR-2P5AB-T	±2.5	800	-40 to 150	Tape and Reel, 3000 pieces per reel
ACS724LLCTR-05AU-T	5			
ACS724LLCTR-05AB-T	±5	400		
ACS724LLCTR-10AU-T	10			
ACS724LLCTR-10AB-T	±10	200		
ACS724LLCTR-20AU-T	20			
ACS724LLCTR-20AB-T	±20	100		
ACS724LLCTR-30AU-T	30	133		
ACS724LLCTR-30AB-T	±30	66		
ACS724LLCTR-50AB-T	±50	40		

[1] -S denotes the lead-free construction with tin-silver-based solder bumps.

[2] -T denotes Pb-contained construction with Pb-based solder bumps. Operating performance of -T and -S devices are identical. -T devices are RoHS compliant using allowed exemptions provided in Annex III and IV of Directive 2011/65/EU [Exemptions 7(a), 15, 15(a), as applicable].

SPECIFICATIONS

ABSOLUTE MAXIMUM RATINGS

Characteristic	Symbol	Notes	Rating	Units
Supply Voltage	V_{CC}		6	V
Reverse Supply Voltage	V_{RCC}		-0.1	V
Output Voltage	V_{IOUT}		$V_{CC} + 0.5$	V
Reverse Output Voltage	V_{RIOUT}		-0.1	V
Operating Ambient Temperature	T_A	Range L	-40 to 150	°C
Junction Temperature	$T_J(\text{max})$		165	°C
Storage Temperature	T_{stg}		-65 to 165	°C

ISOLATION CHARACTERISTICS

Characteristic	Symbol	Notes	Rating	Unit
Dielectric Surge Strength Test Voltage [1]	V_{SURGE}	Tested ± 5 pulses at 2/minute in compliance to IEC 61000-4-5 1.2 μs (rise) / 50 μs (width).	6000	V
Dielectric Strength Test Voltage [1]	V_{ISO}	Agency type-tested for 60 seconds per UL standard 60950-1 (edition 2); production-tested at V_{ISO} for 1 second, in accordance with UL 60950-1 (edition 2).	2400	V_{RMS}
Working Voltage for Basic Isolation [1]	V_{WVBI}	Maximum approved working voltage for basic (single) isolation according to UL 60950-1 (edition 2)	420	V_{pk} or VDC
			297	V_{rms}
Clearance	D_{cl}	Minimum distance through air from IP leads to signal leads.	4.2	mm
Creepage	D_{cr}	Minimum distance along package body from IP leads to signal leads.	4.2	mm
Comparative Tracking Index	CTI	Material Group II	400 to 599	V

[1] Certification pending.

THERMAL CHARACTERISTICS

Characteristic	Symbol	Test Conditions*	Value	Units
Package Thermal Resistance (Junction to Ambient)	$R_{\theta JA}$	Mounted on the Allegro 85-0740 evaluation board with 1500 mm ² of 4 oz. copper on each side, connected to pins 1 and 2, and to pins 3 and 4, with thermal vias connecting the layers. Performance values include the power consumed by the PCB.	23	°C/W
Package Thermal Resistance (Junction to Lead)	$R_{\theta JL}$	Mounted on the Allegro ASEK724 evaluation board.	5	°C/W

*Additional thermal information available on the Allegro website.

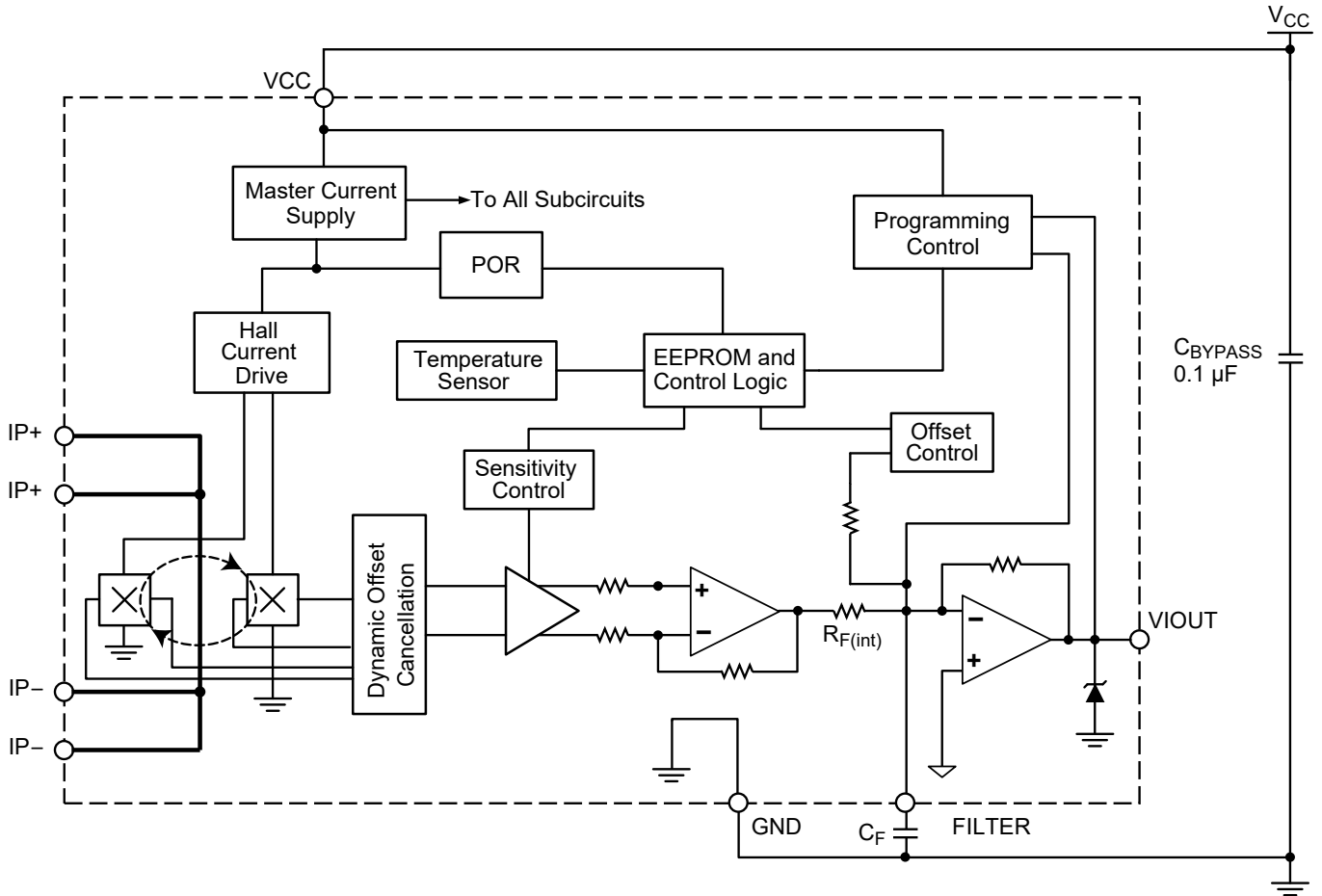

Functional Block Diagram

PINOUT DIAGRAM AND TERMINAL LIST TABLE

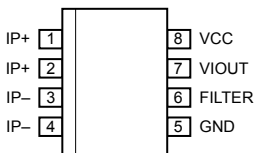

Package LC, 8-Pin SOICN
Pinout Diagram

Terminal List Table

Number	Name	Description
1, 2	IP+	Terminals for current being sensed; fused internally
3, 4	IP-	Terminals for current being sensed; fused internally
5	GND	Signal ground terminal
6	FILTER	Terminal for external capacitor that sets bandwidth
7	VIOUT	Analog output signal
8	VCC	Device power supply terminal

COMMON ELECTRICAL CHARACTERISTICS [1]: Valid through the full range of T_A , $V_{CC} = 5\text{ V}$, $C_F = 0$, unless otherwise specified

Characteristic	Symbol	Test Conditions	Min.	Typ.	Max.	Unit
Supply Voltage	V_{CC}		4.5	–	5.5	V
Supply Current	I_{CC}	$V_{CC} = 5\text{ V}$, output open	–	10	14	mA
Output Capacitance Load	C_L	VIOUT to GND	–	–	10	nF
Output Resistive Load	R_L	VIOUT to GND	4.7	–	–	k Ω
Primary Conductor Resistance	R_{IP}	$T_A = 25^\circ\text{C}$	–	1.2	–	m Ω
Primary Conductor Inductance	L_{IP}	$T_A = 25^\circ\text{C}$	–	2	–	nH
Internal Filter Resistance [2]	$R_{F(int)}$		–	1.8	–	k Ω
Common Mode Field Rejection Ratio	CMFRR	Uniform external magnetic field	–	40	–	dB
Primary Hall Coupling Factor	G1	$T_A = 25^\circ\text{C}$	–	11	–	G/A
Secondary Hall Coupling Factor	G2	$T_A = 25^\circ\text{C}$	–	2.8	–	G/A
Hall Plate Sensitivity Matching	Sens _{match}	$T_A = 25^\circ\text{C}$	–	± 1	–	%
Rise Time	t_r	$T_A = 25^\circ\text{C}$, $C_L = 1\text{ nF}$	–	3	–	μs
Propagation Delay	t_{pd}	$T_A = 25^\circ\text{C}$, $C_L = 1\text{ nF}$	–	2	–	μs
Response Time	$t_{RESPONSE}$	$T_A = 25^\circ\text{C}$, $C_L = 1\text{ nF}$	–	4	–	μs
Output Slew Rate	SR	$T_A = 25^\circ\text{C}$, $C_L = 1\text{ nF}$	–	0.53	–	V/ μs
Bandwidth	BW	Small signal -3 dB ; $C_L = 1\text{ nF}$	–	120	–	kHz
Noise Density	I_{ND}	Input-referenced noise density; $T_A = 25^\circ\text{C}$, $C_L = 1\text{ nF}$	–	150	–	$\mu\text{A}_{(rms)}/\sqrt{\text{Hz}}$
Noise	I_N	Input-referenced noise: $C_F = 4.7\text{ nF}$, $C_L = 1\text{ nF}$, BW = 18 kHz, $T_A = 25^\circ\text{C}$	–	25	–	$\text{mA}_{(rms)}$
Nonlinearity	E_{LIN}	Through full range of I_P	-1.5	–	1.5	%
Sensitivity Ratiometry Coefficient	SENS_RAT_COEF	$V_{CC} = 4.5\text{ to }5.5\text{ V}$, $T_A = 25^\circ\text{C}$	–	1.3	–	–
Zero-Current Output Ratiometry Coefficient	QVO_RAT_COEF	$V_{CC} = 4.5\text{ to }5.5\text{ V}$, $T_A = 25^\circ\text{C}$	–	1	–	–
Saturation Voltage [3]	V_{OH}	$R_L = 4.7\text{ k}\Omega$	–	$V_{CC} - 0.3$	–	V
	V_{OL}	$R_L = 4.7\text{ k}\Omega$	–	0.3	–	V
Power-On Time	t_{PO}	$T_A = 25^\circ\text{C}$	–	80	–	μs
Shorted Output-to-Ground Current	$I_{SC(GND)}$	$T_A = 25^\circ\text{C}$	–	3.3	–	mA
Shorted Output-to- V_{CC} Current	$I_{SC(VCC)}$	$T_A = 25^\circ\text{C}$	–	45	–	mA

[1] Device may be operated at higher primary current levels, I_P , ambient temperatures, T_A , and internal leadframe temperatures, provided the Maximum Junction Temperature, $T_J(\text{max})$, is not exceeded.

[2] $R_{F(int)}$ forms an RC circuit via the FILTER pin.

[3] The sensor IC will continue to respond to current beyond the range of I_P until the high or low saturation voltage; however, the nonlinearity in this region will be worse than through the rest of the measurement range.

xLLCTR-2P5AB PERFORMANCE CHARACTERISTICS: T_A Range L, valid at $T_A = -40^\circ\text{C}$ to 150°C , $V_{CC} = 5\text{ V}$, unless otherwise specified

Characteristic	Symbol	Test Conditions	Min.	Typ. ^[1]	Max.	Unit
NOMINAL PERFORMANCE						
Current Sensing Range	I_{PR}		-2.5	-	2.5	A
Sensitivity	Sens	$I_{PR(\min)} < I_P < I_{PR(\max)}$	-	800	-	mV/A
Zero-Current Output Voltage	$V_{IOUT(Q)}$	Bidirectional, $I_P = 0\text{ A}$	-	$V_{CC} \times 0.5$	-	V
ACCURACY PERFORMANCE						
Total Output Error ^[2]	E_{TOT}	$I_P = I_{PR(\max)}$, $T_A = 25^\circ\text{C}$ to 150°C	-2.5	± 1.5	2.5	%
		$I_P = I_{PR(\max)}$, $T_A = -40^\circ\text{C}$ to 25°C	-6.5	± 4.5	6.5	%
TOTAL OUTPUT ERROR COMPONENTS ^[3] $E_{TOT} = E_{SENS} + 100 \times V_{OE} / (\text{Sens} \times I_P)$						
Sensitivity Error	E_{sens}	$I_P = I_{PR(\max)}$, $T_A = 25^\circ\text{C}$ to 150°C	-2	± 1	2	%
		$I_P = I_{PR(\max)}$, $T_A = -40^\circ\text{C}$ to 25°C	-6	± 4.5	6	%
Voltage Offset Error	V_{OE}	$I_P = 0\text{ A}$, $T_A = 25^\circ\text{C}$ to 150°C	-20	± 7	20	mV
		$I_P = 0\text{ A}$, $T_A = -40^\circ\text{C}$ to 25°C	-40	± 13	40	mV
LIFETIME DRIFT CHARACTERISTICS						
Sensitivity Error Lifetime Drift	E_{sens_drift}		-3	± 1	3	%
Total Output Error Lifetime Drift	E_{tot_drift}		-3	± 1	3	%

^[1] Typical values with +/- are 3 sigma values.

^[2] Percentage of I_P , with $I_P = I_{PR(\max)}$.

^[3] A single part will not have both the maximum/minimum sensitivity error and maximum/minimum offset voltage, as that would violate the maximum/minimum total output error specification. Also, 3 sigma distribution values are combined by taking the square root of the sum of the squares. See Application Information section.

xLLCTR-05AU PERFORMANCE CHARACTERISTICS: T_A Range L, valid at $T_A = -40^\circ\text{C}$ to 150°C , $V_{CC} = 5\text{ V}$,
unless otherwise specified

Characteristic	Symbol	Test Conditions	Min.	Typ. ^[1]	Max.	Unit
NOMINAL PERFORMANCE						
Current Sensing Range	I_{PR}		0	–	5	A
Sensitivity	Sens	$I_{PR(\min)} < I_P < I_{PR(\max)}$	–	800	–	mV/A
Zero-Current Output Voltage	$V_{IOUT(Q)}$	Unidirectional, $I_P = 0\text{ A}$	–	$V_{CC} \times 0.1$	–	V
ACCURACY PERFORMANCE						
Total Output Error ^[2]	E_{TOT}	$I_P = I_{PR(\max)}$, $T_A = 25^\circ\text{C}$ to 150°C	–2.5	± 0.9	2.5	%
		$I_P = I_{PR(\max)}$, $T_A = -40^\circ\text{C}$ to 25°C	–6.5	± 4.6	6.5	%
TOTAL OUTPUT ERROR COMPONENTS ^[3] $E_{TOT} = E_{SENS} + 100 \times V_{OE}/(\text{Sens} \times I_P)$						
Sensitivity Error	E_{sens}	$I_P = I_{PR(\max)}$, $T_A = 25^\circ\text{C}$ to 150°C	–2	± 0.8	2	%
		$I_P = I_{PR(\max)}$, $T_A = -40^\circ\text{C}$ to 25°C	–6	± 4.5	6	%
Voltage Offset Error	V_{OE}	$I_P = 0\text{ A}$, $T_A = 25^\circ\text{C}$ to 150°C	–20	± 10	20	mV
		$I_P = 0\text{ A}$, $T_A = -40^\circ\text{C}$ to 25°C	–40	± 18	40	mV
LIFETIME DRIFT CHARACTERISTICS						
Sensitivity Error Lifetime Drift	E_{sens_drift}		–3	± 1	3	%
Total Output Error Lifetime Drift	E_{tot_drift}		–3	± 1	3	%

^[1] Typical values with +/- are 3 sigma values.

^[2] Percentage of I_P , with $I_P = I_{PR(\max)}$.

^[3] A single part will not have both the maximum/minimum sensitivity error and maximum/minimum offset voltage, as that would violate the maximum/minimum total output error specification. Also, 3 sigma distribution values are combined by taking the square root of the sum of the squares. See Application Information section.

xLLCTR-05AB PERFORMANCE CHARACTERISTICS: T_A Range L, valid at $T_A = -40^\circ\text{C}$ to 150°C , $V_{CC} = 5\text{ V}$, unless otherwise specified

Characteristic	Symbol	Test Conditions	Min.	Typ. ^[1]	Max.	Unit
NOMINAL PERFORMANCE						
Current Sensing Range	I_{PR}		-5	-	5	A
Sensitivity	Sens	$I_{PR(\min)} < I_P < I_{PR(\max)}$	-	400	-	mV/A
Zero-Current Output Voltage	$V_{IOUT(Q)}$	Bidirectional, $I_P = 0\text{ A}$	-	$V_{CC} \times 0.5$	-	V
ACCURACY PERFORMANCE						
Total Output Error ^[2]	E_{TOT}	$I_P = I_{PR(\max)}$, $T_A = 25^\circ\text{C}$ to 150°C	-2.5	± 1.5	2.5	%
		$I_P = I_{PR(\max)}$, $T_A = -40^\circ\text{C}$ to 25°C	-6	± 4.5	6	%
TOTAL OUTPUT ERROR COMPONENTS ^[3] $E_{TOT} = E_{SENS} + 100 \times V_{OE} / (\text{Sens} \times I_P)$						
Sensitivity Error	E_{sens}	$I_P = I_{PR(\max)}$, $T_A = 25^\circ\text{C}$ to 150°C	-2	± 1	2	%
		$I_P = I_{PR(\max)}$, $T_A = -40^\circ\text{C}$ to 25°C	-5.5	± 4.5	5.5	%
Voltage Offset Error	V_{OE}	$I_P = 0\text{ A}$, $T_A = 25^\circ\text{C}$ to 150°C	-15	± 7	15	mV
		$I_P = 0\text{ A}$, $T_A = -40^\circ\text{C}$ to 25°C	-30	± 13	30	mV
LIFETIME DRIFT CHARACTERISTICS						
Sensitivity Error Lifetime Drift	E_{sens_drift}		-3	± 1	3	%
Total Output Error Lifetime Drift	E_{tot_drift}		-3	± 1	3	%

^[1] Typical values with +/- are 3 sigma values.

^[2] Percentage of I_P , with $I_P = I_{PR(\max)}$.

^[3] A single part will not have both the maximum/minimum sensitivity error and maximum/minimum offset voltage, as that would violate the maximum/minimum total output error specification. Also, 3 sigma distribution values are combined by taking the square root of the sum of the squares. See Application Information section.

xLLCTR-10AU PERFORMANCE CHARACTERISTICS: T_A Range L, valid at $T_A = -40^\circ\text{C}$ to 150°C , $V_{CC} = 5\text{ V}$, unless otherwise specified

Characteristic	Symbol	Test Conditions	Min.	Typ. ^[1]	Max.	Unit
NOMINAL PERFORMANCE						
Current-Sensing Range	I_{PR}		0	–	10	A
Sensitivity	Sens	$I_{PR(\min)} < I_P < I_{PR(\max)}$	–	400	–	mV/A
Zero-Current Output Voltage	$V_{IOUT(Q)}$	Unidirectional, $I_P = 0\text{ A}$	–	$V_{CC} \times 0.1$	–	V
ACCURACY PERFORMANCE						
Total Output Error ^[2]	E_{TOT}	$I_P = I_{PR(\max)}$, $T_A = 25^\circ\text{C}$ to 150°C	–2.5	± 1.5	2.5	%
		$I_P = I_{PR(\max)}$, $T_A = -40^\circ\text{C}$ to 25°C	–6	± 4.5	6	%
TOTAL OUTPUT ERROR COMPONENTS ^[3] $E_{TOT} = E_{SENS} + 100 \times V_{OE}/(\text{Sens} \times I_P)$						
Sensitivity Error	E_{sens}	$I_P = I_{PR(\max)}$, $T_A = 25^\circ\text{C}$ to 150°C	–2	± 1	2	%
		$I_P = I_{PR(\max)}$, $T_A = -40^\circ\text{C}$ to 25°C	–5.5	± 4.5	5.5	%
Voltage Offset Error	V_{OE}	$I_P = 0\text{ A}$, $T_A = 25^\circ\text{C}$ to 150°C	–15	± 7	15	mV
		$I_P = 0\text{ A}$, $T_A = -40^\circ\text{C}$ to 25°C	–30	± 13	30	mV
LIFETIME DRIFT CHARACTERISTICS						
Sensitivity Error Lifetime Drift	E_{sens_drift}		–3	± 1	3	%
Total Output Error Lifetime Drift	E_{tot_drift}		–3	± 1	3	%

^[1] Typical values with +/- are 3 sigma values.

^[2] Percentage of I_P , with $I_P = I_{PR(\max)}$.

^[3] A single part will not have both the maximum/minimum sensitivity error and maximum/minimum offset voltage, as that would violate the maximum/minimum total output error specification. Also, 3 sigma distribution values are combined by taking the square root of the sum of the squares. See Application Information section.

xLLCTR-10AB PERFORMANCE CHARACTERISTICS: T_A Range L, valid at $T_A = -40^\circ\text{C}$ to 150°C , $V_{CC} = 5\text{ V}$, unless otherwise specified

Characteristic	Symbol	Test Conditions	Min.	Typ. ^[1]	Max.	Unit
NOMINAL PERFORMANCE						
Current-Sensing Range	I_{PR}		-10	-	10	A
Sensitivity	Sens	$I_{PR(\min)} < I_P < I_{PR(\max)}$	-	200	-	mV/A
Zero-Current Output Voltage	$V_{IOUT(Q)}$	Bidirectional, $I_P = 0\text{ A}$	-	$V_{CC} \times 0.5$	-	V
ACCURACY PERFORMANCE						
Total Output Error [2]	E_{TOT}	$I_P = I_{PR(\max)}$, $T_A = 25^\circ\text{C}$ to 150°C	-2	± 1	2	%
		$I_P = I_{PR(\max)}$, $T_A = -40^\circ\text{C}$ to 25°C	-6	± 4.5	6	%
TOTAL OUTPUT ERROR COMPONENTS [3] $E_{TOT} = E_{SENS} + 100 \times V_{OE} / (\text{Sens} \times I_P)$						
Sensitivity Error	E_{sens}	$I_P = I_{PR(\max)}$, $T_A = 25^\circ\text{C}$ to 150°C	-1.5	± 1	1.5	%
		$I_P = I_{PR(\max)}$, $T_A = -40^\circ\text{C}$ to 25°C	-5.5	± 4.5	5.5	%
Voltage Offset Error	V_{OE}	$I_P = 0\text{ A}$, $T_A = 25^\circ\text{C}$ to 150°C	-10	± 6	10	mV
		$I_P = 0\text{ A}$, $T_A = -40^\circ\text{C}$ to 25°C	-30	± 8	30	mV
LIFETIME DRIFT CHARACTERISTICS						
Sensitivity Error Lifetime Drift	E_{sens_drift}		-3	± 1	3	%
Total Output Error Lifetime Drift	E_{tot_drift}		-3	± 1	3	%

[1] Typical values with +/- are 3 sigma values.

[2] Percentage of I_P , with $I_P = I_{PR(\max)}$.

[3] A single part will not have both the maximum/minimum sensitivity error and maximum/minimum offset voltage, as that would violate the maximum/minimum total output error specification. Also, 3 sigma distribution values are combined by taking the square root of the sum of the squares. See Application Information section.

xLLCTR-20AU PERFORMANCE CHARACTERISTICS: T_A Range L, valid at $T_A = -40^\circ\text{C}$ to 150°C , $V_{CC} = 5\text{ V}$, unless otherwise specified

Characteristic	Symbol	Test Conditions	Min.	Typ. ^[1]	Max.	Unit
NOMINAL PERFORMANCE						
Current-Sensing Range	I_{PR}		0	–	20	A
Sensitivity	Sens	$I_{PR(\min)} < I_P < I_{PR(\max)}$	–	200	–	mV/A
Zero-Current Output Voltage	$V_{IOUT(Q)}$	Unidirectional, $I_P = 0\text{ A}$	–	$V_{CC} \times 0.1$	–	V
ACCURACY PERFORMANCE						
Total Output Error ^[2]	E_{TOT}	$I_P = I_{PR(\max)}$, $T_A = 25^\circ\text{C}$ to 150°C	–2	± 0.7	2	%
		$I_P = I_{PR(\max)}$, $T_A = -40^\circ\text{C}$ to 25°C	–6	± 4	6	%
TOTAL OUTPUT ERROR COMPONENTS ^[3] $E_{TOT} = E_{SENS} + 100 \times V_{OE}/(\text{Sens} \times I_P)$						
Sensitivity Error	E_{sens}	$I_P = I_{PR(\max)}$, $T_A = 25^\circ\text{C}$ to 150°C	–1.5	± 0.7	1.5	%
		$I_P = I_{PR(\max)}$, $T_A = -40^\circ\text{C}$ to 25°C	–5.5	± 4	5.5	%
Voltage Offset Error	V_{OE}	$I_P = 0\text{ A}$, $T_A = 25^\circ\text{C}$ to 150°C	–10	± 6	10	mV
		$I_P = 0\text{ A}$, $T_A = -40^\circ\text{C}$ to 25°C	–30	± 8	30	mV
LIFETIME DRIFT CHARACTERISTICS						
Sensitivity Error Lifetime Drift	E_{sens_drift}		–3	± 1	3	%
Total Output Error Lifetime Drift	E_{tot_drift}		–3	± 1	3	%

^[1] Typical values with +/- are 3 sigma values.

^[2] Percentage of I_P , with $I_P = I_{PR(\max)}$.

^[3] A single part will not have both the maximum/minimum sensitivity error and maximum/minimum offset voltage, as that would violate the maximum/minimum total output error specification. Also, 3 sigma distribution values are combined by taking the square root of the sum of the squares. See Application Information section.

xLLCTR-20AB PERFORMANCE CHARACTERISTICS: T_A Range L, valid at $T_A = -40^\circ\text{C}$ to 150°C , $V_{CC} = 5\text{ V}$, unless otherwise specified

Characteristic	Symbol	Test Conditions	Min.	Typ. ^[1]	Max.	Unit
NOMINAL PERFORMANCE						
Current-Sensing Range	I_{PR}		-20	-	20	A
Sensitivity	Sens	$I_{PR(\min)} < I_P < I_{PR(\max)}$	-	100	-	mV/A
Zero-Current Output Voltage	$V_{IOUT(Q)}$	Bidirectional, $I_P = 0\text{ A}$	-	$V_{CC} \times 0.5$	-	V
ACCURACY PERFORMANCE						
Total Output Error [2]	E_{TOT}	$I_P = I_{PR(\max)}$, $T_A = 25^\circ\text{C}$ to 150°C	-2	± 0.8	2	%
		$I_P = I_{PR(\max)}$, $T_A = -40^\circ\text{C}$ to 25°C	-6	± 4	6	%
TOTAL OUTPUT ERROR COMPONENTS [3] $E_{TOT} = E_{SENS} + 100 \times V_{OE} / (\text{Sens} \times I_P)$						
Sensitivity Error	E_{sens}	$I_P = I_{PR(\max)}$, $T_A = 25^\circ\text{C}$ to 150°C	-1.5	± 0.6	1.5	%
		$I_P = I_{PR(\max)}$, $T_A = -40^\circ\text{C}$ to 25°C	-5.5	± 4	5.5	%
Voltage Offset Error	V_{OE}	$I_P = 0\text{ A}$, $T_A = 25^\circ\text{C}$ to 150°C	-10	± 5	10	mV
		$I_P = 0\text{ A}$, $T_A = -40^\circ\text{C}$ to 25°C	-30	± 6	30	mV
LIFETIME DRIFT CHARACTERISTICS						
Sensitivity Error Lifetime Drift	E_{sens_drift}		-3	± 1	3	%
Total Output Error Lifetime Drift	E_{tot_drift}		-3	± 1	3	%

[1] Typical values with +/- are 3 sigma values.

[2] Percentage of I_P , with $I_P = I_{PR(\max)}$.

[3] A single part will not have both the maximum/minimum sensitivity error and maximum/minimum offset voltage, as that would violate the maximum/minimum total output error specification. Also, 3 sigma distribution values are combined by taking the square root of the sum of the squares. See Application Information section.

xLLCTR-30AU PERFORMANCE CHARACTERISTICS: T_A Range L, valid at $T_A = -40^\circ\text{C}$ to 150°C , $V_{CC} = 5\text{ V}$, unless otherwise specified

Characteristic	Symbol	Test Conditions	Min.	Typ. ^[1]	Max.	Unit
NOMINAL PERFORMANCE						
Current-Sensing Range	I_{PR}		0	–	30	A
Sensitivity	Sens	$I_{PR(\min)} < I_P < I_{PR(\max)}$	–	133	–	mV/A
Zero-Current Output Voltage	$V_{IOUT(Q)}$	Unidirectional, $I_P = 0\text{ A}$	–	$V_{CC} \times 0.1$	–	V
ACCURACY PERFORMANCE						
Total Output Error ^[2]	E_{TOT}	$I_P = I_{PR(\max)}$, $T_A = 25^\circ\text{C}$ to 150°C	–2	± 0.7	2	%
		$I_P = I_{PR(\max)}$, $T_A = -40^\circ\text{C}$ to 25°C	–6	± 4	6	%
TOTAL OUTPUT ERROR COMPONENTS ^[3] $E_{TOT} = E_{SENS} + 100 \times V_{OE} / (\text{Sens} \times I_P)$						
Sensitivity Error	E_{sens}	$I_P = I_{PR(\max)}$, $T_A = 25^\circ\text{C}$ to 150°C	–1.5	± 0.7	1.5	%
		$I_P = I_{PR(\max)}$, $T_A = -40^\circ\text{C}$ to 25°C	–5.5	± 4	5.5	%
Voltage Offset Error	V_{OE}	$I_P = 0\text{ A}$, $T_A = 25^\circ\text{C}$ to 150°C	–10	± 6	10	mV
		$I_P = 0\text{ A}$, $T_A = -40^\circ\text{C}$ to 25°C	–30	± 7	30	mV
LIFETIME DRIFT CHARACTERISTICS						
Sensitivity Error Lifetime Drift	E_{sens_drift}		–3	± 1	3	%
Total Output Error Lifetime Drift	E_{tot_drift}		–3	± 1	3	%

^[1] Typical values with +/- are 3 sigma values.

^[2] Percentage of I_P , with $I_P = I_{PR(\max)}$.

^[3] A single part will not have both the maximum/minimum sensitivity error and maximum/minimum offset voltage, as that would violate the maximum/minimum total output error specification. Also, 3 sigma distribution values are combined by taking the square root of the sum of the squares. See Application Information section.

xLLCTR-30AB PERFORMANCE CHARACTERISTICS: T_A Range L, valid at $T_A = -40^\circ\text{C}$ to 150°C , $V_{CC} = 5\text{ V}$, unless otherwise specified

Characteristic	Symbol	Test Conditions	Min.	Typ. ^[1]	Max.	Unit
NOMINAL PERFORMANCE						
Current-Sensing Range	I_{PR}		-30	-	30	A
Sensitivity	Sens	$I_{PR(\min)} < I_P < I_{PR(\max)}$	-	66	-	mV/A
Zero-Current Output Voltage	$V_{IOUT(Q)}$	Bidirectional, $I_P = 0\text{ A}$	-	$V_{CC} \times 0.5$	-	V
ACCURACY PERFORMANCE						
Total Output Error ^[2]	E_{TOT}	$I_P = I_{PR(\max)}$, $T_A = 25^\circ\text{C}$ to 150°C	-2	± 0.8	2	%
		$I_P = I_{PR(\max)}$, $T_A = -40^\circ\text{C}$ to 25°C	-6	± 4	6	%
TOTAL OUTPUT ERROR COMPONENTS ^[3] $E_{TOT} = E_{SENS} + 100 \times V_{OE} / (\text{Sens} \times I_P)$						
Sensitivity Error	E_{sens}	$I_P = I_{PR(\max)}$, $T_A = 25^\circ\text{C}$ to 150°C	-1.5	± 0.8	1.5	%
		$I_P = I_{PR(\max)}$, $T_A = -40^\circ\text{C}$ to 25°C	-5.5	± 4	5.5	%
Voltage Offset Error	V_{OE}	$I_P = 0\text{ A}$, $T_A = 25^\circ\text{C}$ to 150°C	-10	± 6	10	mV
		$I_P = 0\text{ A}$, $T_A = -40^\circ\text{C}$ to 25°C	-30	± 6	30	mV
LIFETIME DRIFT CHARACTERISTICS						
Sensitivity Error Lifetime Drift	E_{sens_drift}		-3	± 1	3	%
Total Output Error Lifetime Drift	E_{tot_drift}		-3	± 1	3	%

^[1] Typical values with +/- are 3 sigma values.

^[2] Percentage of I_P , with $I_P = I_{PR(\max)}$.

^[3] A single part will not have both the maximum/minimum sensitivity error and maximum/minimum offset voltage, as that would violate the maximum/minimum total output error specification. Also, 3 sigma distribution values are combined by taking the square root of the sum of the squares. See Application Information section.

xLLCTR-50AB PERFORMANCE CHARACTERISTICS: T_A Range L, valid at $T_A = -40^\circ\text{C}$ to 150°C , $V_{CC} = 5\text{ V}$, $C_F = 0$, unless otherwise specified

Characteristic	Symbol	Test Conditions	Min.	Typ. ^[1]	Max.	Unit
NOMINAL PERFORMANCE						
Current-Sensing Range	I_{PR}		-50	-	50	A
Sensitivity	Sens	$I_{PR(\min)} < I_P < I_{PR(\max)}$	-	40	-	mV/A
Zero-Current Output Voltage	$V_{IOUT(Q)}$	Bidirectional, $I_P = 0\text{ A}$	-	$V_{CC} \times 0.5$	-	V
ACCURACY PERFORMANCE						
Total Output Error ^[2]	E_{TOT}	$I_P = I_{PR(\max)}$, $T_A = 25^\circ\text{C}$ to 150°C	-2	± 0.8	2	%
		$I_P = I_{PR(\max)}$, $T_A = -40^\circ\text{C}$ to 25°C	-6	± 4	6	%
TOTAL OUTPUT ERROR COMPONENTS ^[3] $E_{TOT} = E_{SENS} + 100 \times V_{OE} / (\text{Sens} \times I_P)$						
Sensitivity Error	E_{sens}	$I_P = I_{PR(\max)}$, $T_A = 25^\circ\text{C}$ to 150°C	-1.5	± 0.8	1.5	%
		$I_P = I_{PR(\max)}$, $T_A = -40^\circ\text{C}$ to 25°C	-5.5	± 4	5.5	%
Voltage Offset Error	V_{OE}	$I_P = 0\text{ A}$, $T_A = 25^\circ\text{C}$ to 150°C	-10	± 6	10	mV
		$I_P = 0\text{ A}$, $T_A = -40^\circ\text{C}$ to 25°C	-30	± 6	30	mV
LIFETIME DRIFT CHARACTERISTICS						
Sensitivity Error Lifetime Drift	E_{sens_drift}		-3	± 1	3	%
Total Output Error Lifetime Drift	E_{tot_drift}		-3	± 1	3	%

^[1] Typical values with +/- are 3 sigma values.

^[2] Percentage of I_P , with $I_P = I_{PR(\max)}$.

^[3] A single part will not have both the maximum/minimum sensitivity error and maximum/minimum offset voltage, as that would violate the maximum/minimum total output error specification. Also, 3 sigma distribution values are combined by taking the square root of the sum of the squares. See Application Information section.

CHARACTERISTIC PERFORMANCE ACS724 TYPICAL FREQUENCY RESPONSE

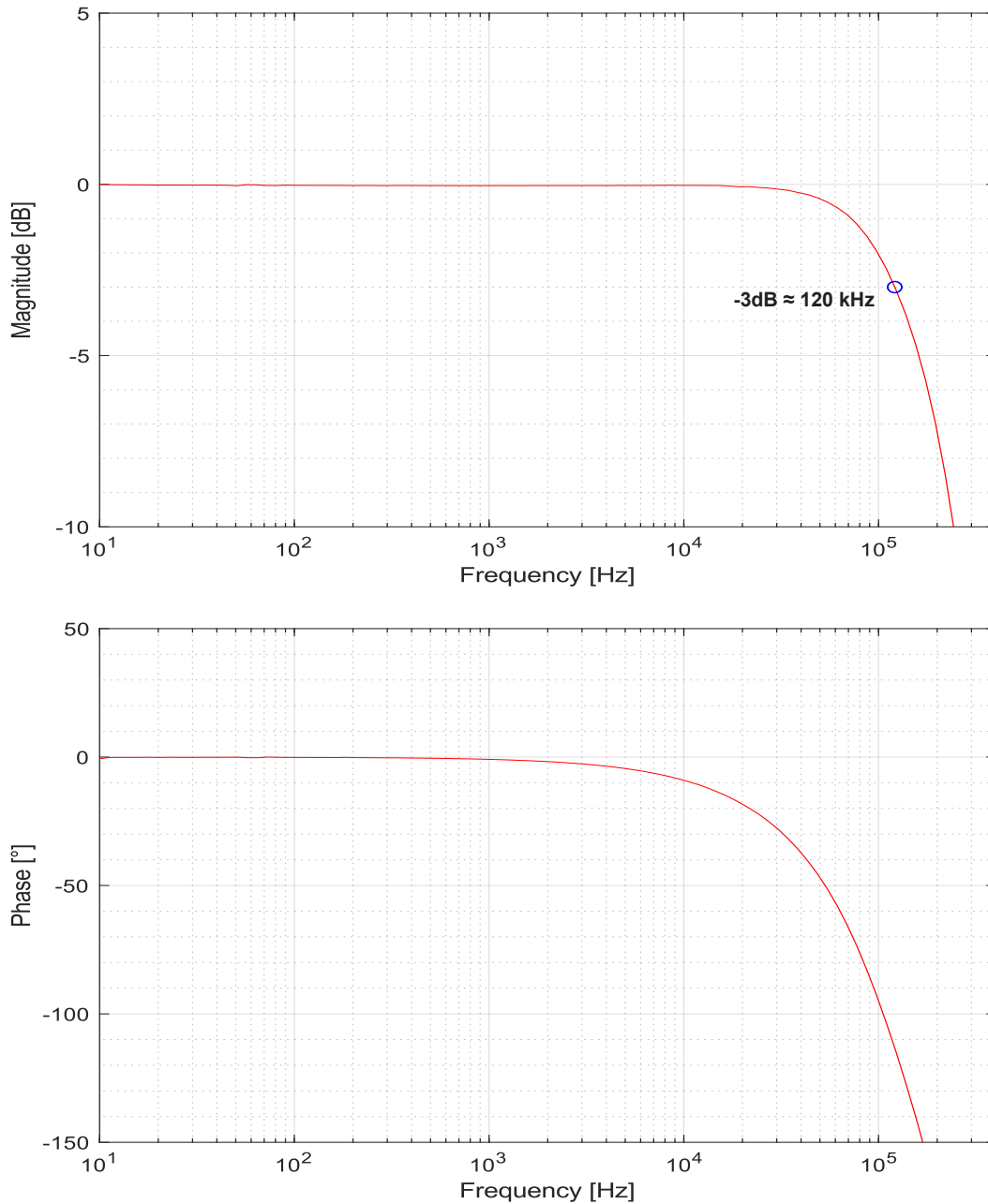

For information regarding bandwidth characterization methods used for the ACS724, see the “Characterizing System Bandwidth” application note (<https://allegromicro.com/en/insights-and-innovations/technical-documents/hall-effect-sensor-ic-publications/an-effective-method-for-characterizing-system-bandwidth-an296169>) on the Allegro website.

RESPONSE CHARACTERISTICS DEFINITIONS AND PERFORMANCE DATA

Response Time (t_{RESPONSE})

The time interval between a) when the sensed input current reaches 90% of its final value, and b) when the sensor output reaches 90% of its full-scale value.

Propagation Delay (t_{pd})

The time interval between a) when the sensed input current reaches 20% of its full-scale value, and b) when the sensor output reaches 20% of its full-scale value.

Rise Time (t_r)

The time interval between a) when the sensor reaches 10% of its full-scale value, and b) when it reaches 90% of its full-scale value.

Output Slew Rate (SR)

The rate of change [$\text{V}/\mu\text{s}$] in the output voltage from a) when the sensor reaches 10% of its full-scale value, and b) when it reaches 90% of its full-scale value.

Response Time, Propagation Delay, Rise Time, and Output Slew Rate

Applied current step with 10%-90% rise time = $1 \mu\text{s}$

Test Conditions: $T_A = 25^\circ\text{C}$, $C_{\text{BYPASS}} = 0.1 \mu\text{F}$, $C_L = 0 \text{ F}$

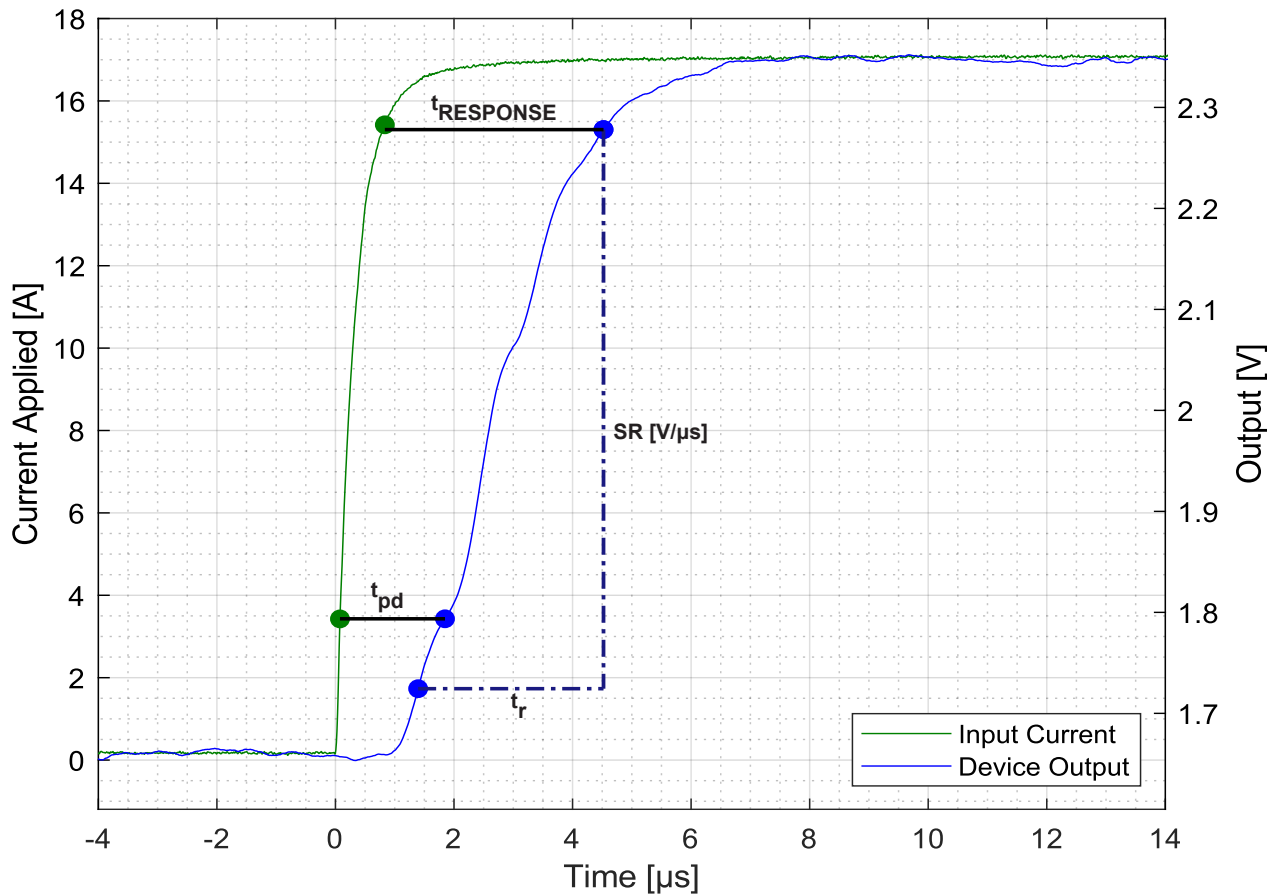

POWER ON FUNCTIONAL DESCRIPTION AND PERFORMANCE DATA

Power-On Time (t_{PO})

When the supply is ramped to its operating voltage, the device requires a finite amount of time to power its internal components before responding to an input magnetic field. Power-On Time (t_{PO}) is defined as the time interval between a) when the power supply has reached its minimum specified operating voltage ($V_{CC(min)}$), and b) when the sensor output has settled within $\pm 10\%$ of its steady-state value under an applied magnetic field.

Power-On Profile

After applying power, the part remains off in a known state referred to as Power-on Reset, or POR. The device stays in this state until the voltage reaches a point at which the device will remain powered. The power-on profile below illustrates the intended power on/off. A pull-down resistor was used on the output of the tested device.

Power-On Time (t_{PO})

Test Conditions: $T_A = 25^\circ\text{C}$, $C_{BYPASS} = 0.1 \mu\text{F}$, $R_{PD} = 10 \text{ k}\Omega$, 1V Output Swing

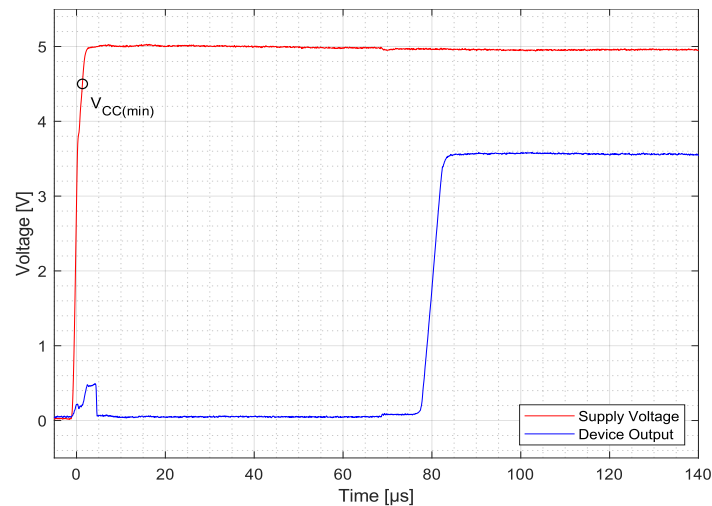

Power-On Profile

Supply voltage ramp rate = 1V/ms

Test Conditions: $T_A = 25^\circ\text{C}$, $C_{BYPASS} = 0.1 \mu\text{F}$, $R_{PD} = 10 \text{ k}\Omega$

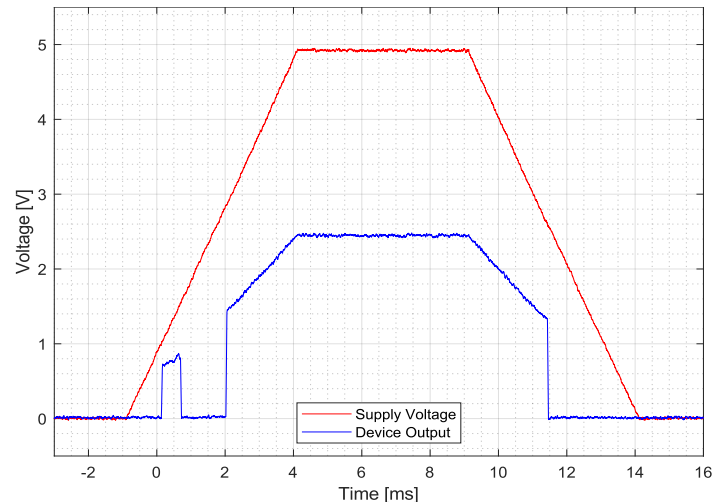

APPLICATION INFORMATION

Estimating Total Error vs. Sensed Current

The Performance Characteristics tables give distribution (± 3 sigma) values for Total Error at $I_{PR(max)}$; however, one often wants to know what error to expect at a particular current. This can be estimated by using the distribution data for the components of Total Error, Sensitivity Error, and Voltage Offset Error. The ± 3 sigma value for Total Error (E_{TOT}) as a function of the sensed current (I_p) is estimated as:

$$E_{TOT}(I_p) = \sqrt{E_{SENS}^2 + \left(\frac{100 \times V_{OE}}{Sens \times I_p}\right)^2}$$

Here, E_{SENS} and V_{OE} are the ± 3 sigma values for those error terms. If there is an average sensitivity error or average offset voltage, then the average Total Error is estimated as:

$$E_{TOT_{AVG}}(I_p) = E_{SENS_{AVG}} + \frac{100 \times V_{OE_{AVG}}}{Sens \times I_p}$$

The resulting total error will be a sum of E_{TOT} and $E_{TOT_{AVG}}$. Using these equations and the 3 sigma distributions for Sensitivity Error and Voltage Offset Error, the Total Error versus sensed current (I_p) is below for the ACS724LLCTR-20AB. As expected, as one goes towards zero current, the error in percent goes towards infinity due to division by zero (refer to Figure 1).

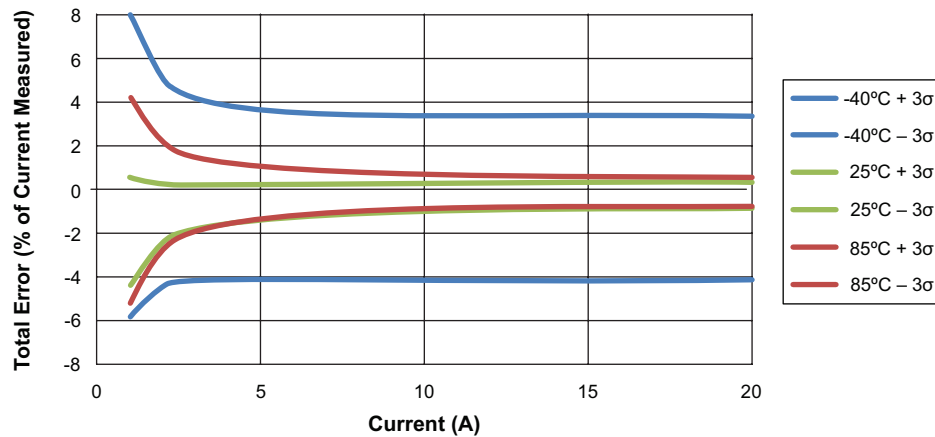

Figure 1: Predicted Total Error as a Function of the Sensed Current for the ACS724LLCTR-20AB

Thermal Rise vs. Primary Current

Self-heating due to the flow of current should be considered during the design of any current sensing system. The sensor, printed circuit board (PCB), and contacts to the PCB will generate heat as current moves through the system.

The thermal response is highly dependent on PCB layout, copper thickness, cooling techniques, and the profile of the injected current. The current profile includes peak current, current “on-time”, and duty cycle. While the data presented in this section was collected with Direct-Current (DC), these numbers may be used to approximate thermal response for both AC signals and current pulses.

The plot in Figure 2 shows the measured rise in steady-state die temperature of the ACS724 versus continuous current at an ambient temperature, T_A , of 25 °C. The thermal offset curves may be directly applied to other values of T_A . Conversely, Figure 3 shows the maximum continuous current at a given T_A . Surges beyond the maximum current listed in Figure 3 are allowed given the maximum junction temperature, $T_{J(MAX)}$ (165°C), is not exceeded.

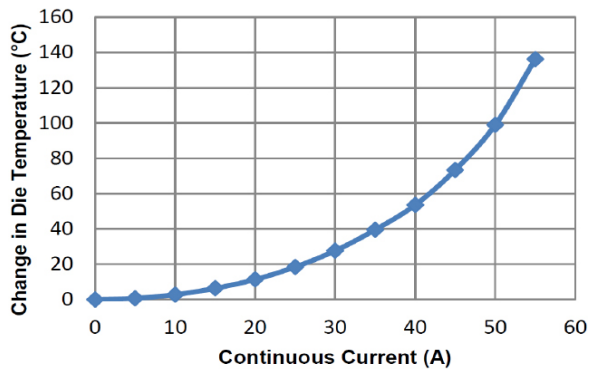

Figure 2: Self Heating in the LC Package Due to Current Flow

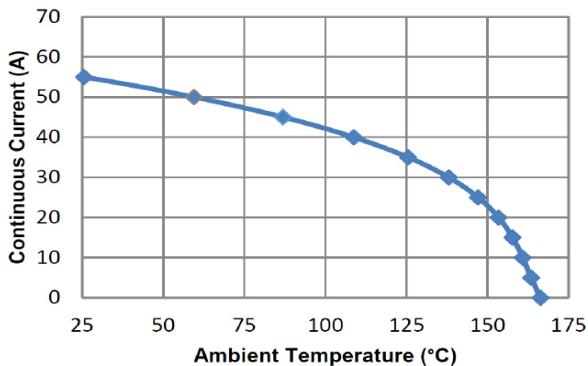

Figure 3: Maximum Continuous Current at a Given T_A

The thermal capacity of the ACS724 should be verified by the end user in the application’s specific conditions. The maximum junction temperature, $T_{J(MAX)}$ (165°C), should not be exceeded. Further information on this application testing is available in the [DC and Transient Current Capability](#) application note on our website.

ASEK724 Evaluation Board Layout

Thermal data shown in Figure 2 and Figure 3 was collected using the ASEK724 Evaluation Board (TED-85-0740-003). This board includes 1500 mm² of 4 oz. copper (0.1388 mm) connected to pins 1 and 2, and to pins 3 and 4, with thermal vias connecting the layers. Top and Bottom layers of the PCB are shown below in Figure 4.

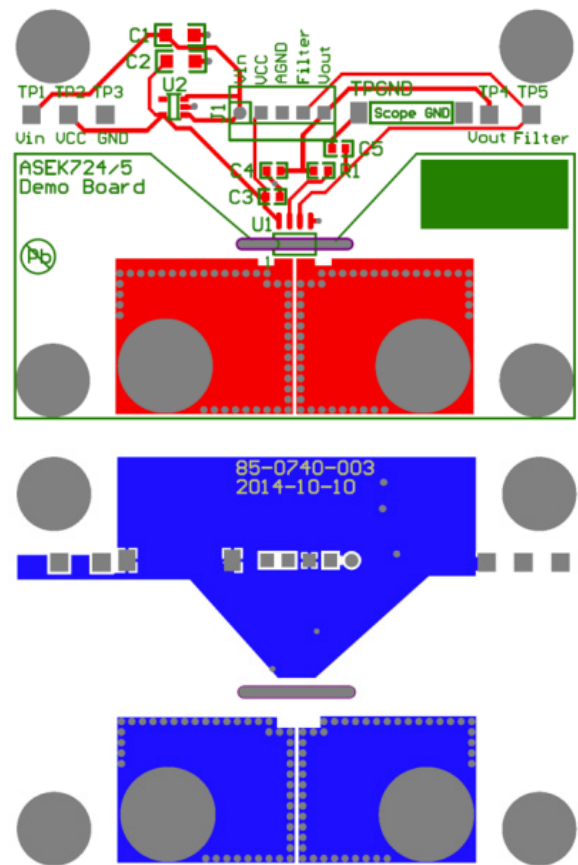

Figure 4: Top and Bottom Layers for ASEK724 Evaluation Board

Gerber files for the ASEK724 evaluation board are available for download from the Allegro website. Please see the technical documents section of the [ACS724](#) device webpage.

DEFINITIONS OF ACCURACY CHARACTERISTICS

Sensitivity (Sens). The change in sensor IC output in response to a 1 A change through the primary conductor. The sensitivity is the product of the magnetic circuit sensitivity (G/A) (1 G = 0.1 mT) and the linear IC amplifier gain (mV/G). The linear IC amplifier gain is programmed at the factory to optimize the sensitivity (mV/A) for the full-scale current of the device.

Nonlinearity (E_{LIN}). The nonlinearity is a measure of how linear the output of the sensor IC is over the full current measurement range. The nonlinearity is calculated as:

$$E_{LIN} = \left\{ 1 - \left[\frac{V_{IOUT}(I_{PR(max)}) - V_{IOUT(Q)}}{2 \cdot V_{IOUT}(I_{PR(max)/2}) - V_{IOUT(Q)}} \right] \right\} \cdot 100(\%)$$

where $V_{IOUT}(I_{PR(max)})$ is the output of the sensor IC with the maximum measurement current flowing through it and $V_{IOUT}(I_{PR(max)/2})$ is the output of the sensor IC with half of the maximum measurement current flowing through it.

Zero-Current Output Voltage ($V_{IOUT(Q)}$). The output of the sensor when the primary current is zero. For a unipolar supply voltage, it nominally remains at $0.5 \times V_{CC}$ for a bidirectional device and $0.1 \times V_{CC}$ for a unidirectional device. For example, in the case of a bidirectional output device, $V_{CC} = 5$ V translates into $V_{IOUT(Q)} = 2.5$ V. Variation in $V_{IOUT(Q)}$ can be attributed to the resolution of the Allegro linear IC quiescent voltage trim and thermal drift.

Voltage Offset Error (V_{OE}). The deviation of the device output from its ideal quiescent value of $0.5 \times V_{CC}$ (bidirectional) or $0.1 \times V_{CC}$ (unidirectional) due to nonmagnetic causes. To convert this voltage to amperes, divide by the device sensitivity, Sens.

Total Output Error (E_{TOT}). The difference between the current measurement from the sensor IC and the actual current (I_p), relative to the actual current. This is equivalent to the difference between the ideal output voltage and the actual output voltage, divided by the ideal sensitivity, relative to the current flowing through the primary conduction path:

$$E_{TOT}(I_p) = \frac{V_{IOUT,ideal}(I_p) - V_{IOUT}(I_p)}{Sens_{ideal}(I_p) \cdot I_p} \cdot 100(\%)$$

The Total Output Error incorporates all sources of error and is a function of I_p . At relatively high currents, E_{TOT} will be mostly due to sensitivity error, and at relatively low currents, E_{TOT} will be mostly due to Voltage Offset Error (V_{OE}). In fact, at $I_p = 0$, E_{TOT} approaches infinity due to the offset. This is illustrated in Figure 5 and Figure 6. Figure 5 shows a distribution of output voltages versus I_p at 25°C and across temperature. Figure 6 shows the corresponding E_{TOT} versus I_p .

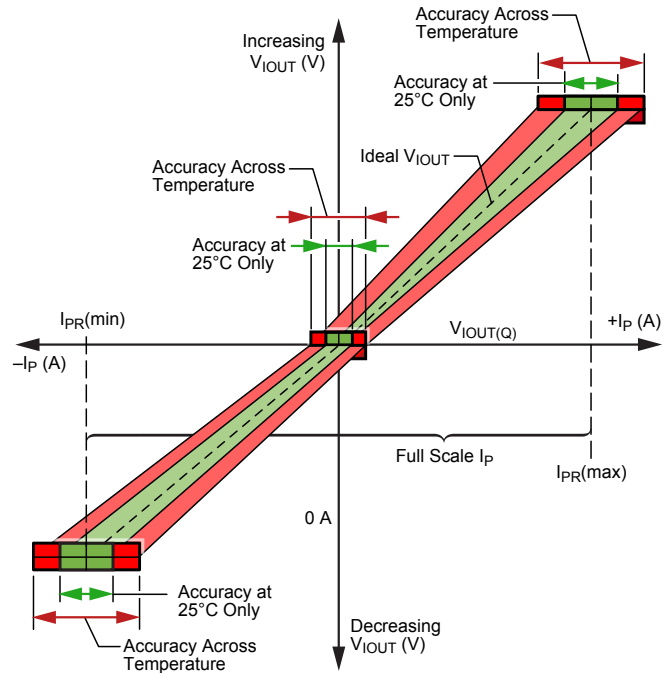

Figure 5: Output Voltage versus Sensed Current

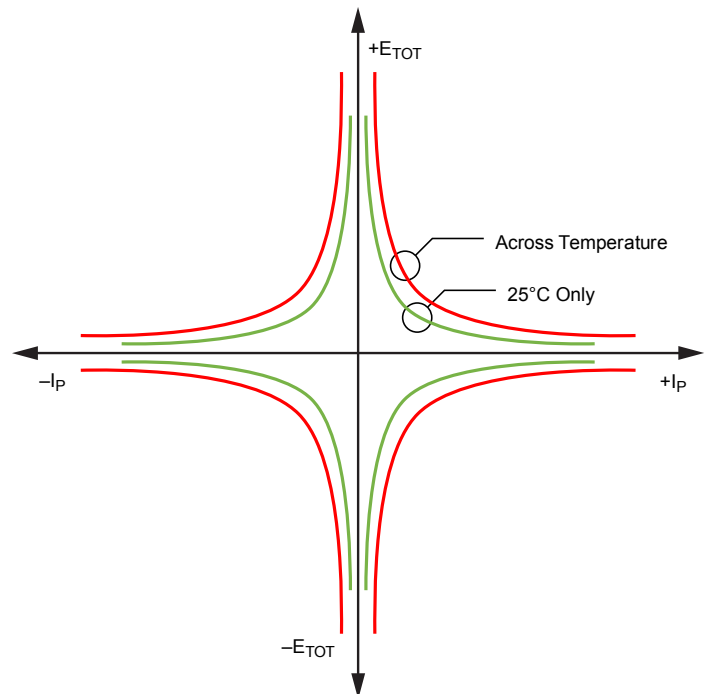

Figure 6: Total Output Error versus Sensed Current

Sensitivity Ratiometry Coefficient (SENS_RAT_COEF). The coefficient defining how the sensitivity scales with V_{CC} . The ideal coefficient is 1, meaning the sensitivity scales proportionally with V_{CC} . A 10% increase in V_{CC} results in a 10% increase in sensitivity. A coefficient of 1.1 means that the sensitivity increases by 10% more than the ideal proportionality case. This means that a 10% increase in V_{CC} results in an 11% increase in sensitivity. This relationship is described by the following equation:

$$Sens(V_{cc}) = Sens(5 V) \left[1 + \frac{(V_{cc} - 5 V) \cdot SENS_RAT_COEF}{5 V} \right]$$

This can be rearranged to define the sensitivity ratiometry coefficient as:

$$SENS_RAT_COEF = \left[\frac{Sens(V_{cc})}{Sens(5 V)} - 1 \right] \cdot \frac{5 V}{(V_{cc} - 5 V)}$$

Zero-Current Output Ratiometry Coefficient (QVO_RAT_COEF). The coefficient defining how the zero-current output voltage scales with V_{CC} . The ideal coefficient is 1, meaning the output voltage scales proportionally with V_{CC} , always being equal to $V_{CC}/2$. A coefficient of 1.1 means that the zero-current output voltage increases by 10% more than the ideal proportionality case. This means that a 10% increase in V_{CC} results in an 11% increase in the zero-current output voltage. This relationship is described by the following equation:

$$VIOUTQ(V_{cc}) = VIOUTQ(5 V) \left[1 + \frac{(V_{cc} - 5 V) \cdot QVO_RAT_COEF}{5 V} \right]$$

This can be rearranged to define the zero-current output ratiometry coefficient as:

$$QVO_RAT_COEF = \left[\frac{VIOUTQ(V_{cc})}{VIOUTQ(5 V)} - 1 \right] \cdot \frac{5 V}{(V_{cc} - 5 V)}$$

PACKAGE OUTLINING DRAWING

For Reference Only – Not for Tooling Use

(Reference MS-012AA)
 Dimensions in millimeters – NOT TO SCALE
 Dimensions exclusive of mold flash, gate burrs, and dambar protrusions
 Exact case and lead configuration at supplier discretion within limits shown

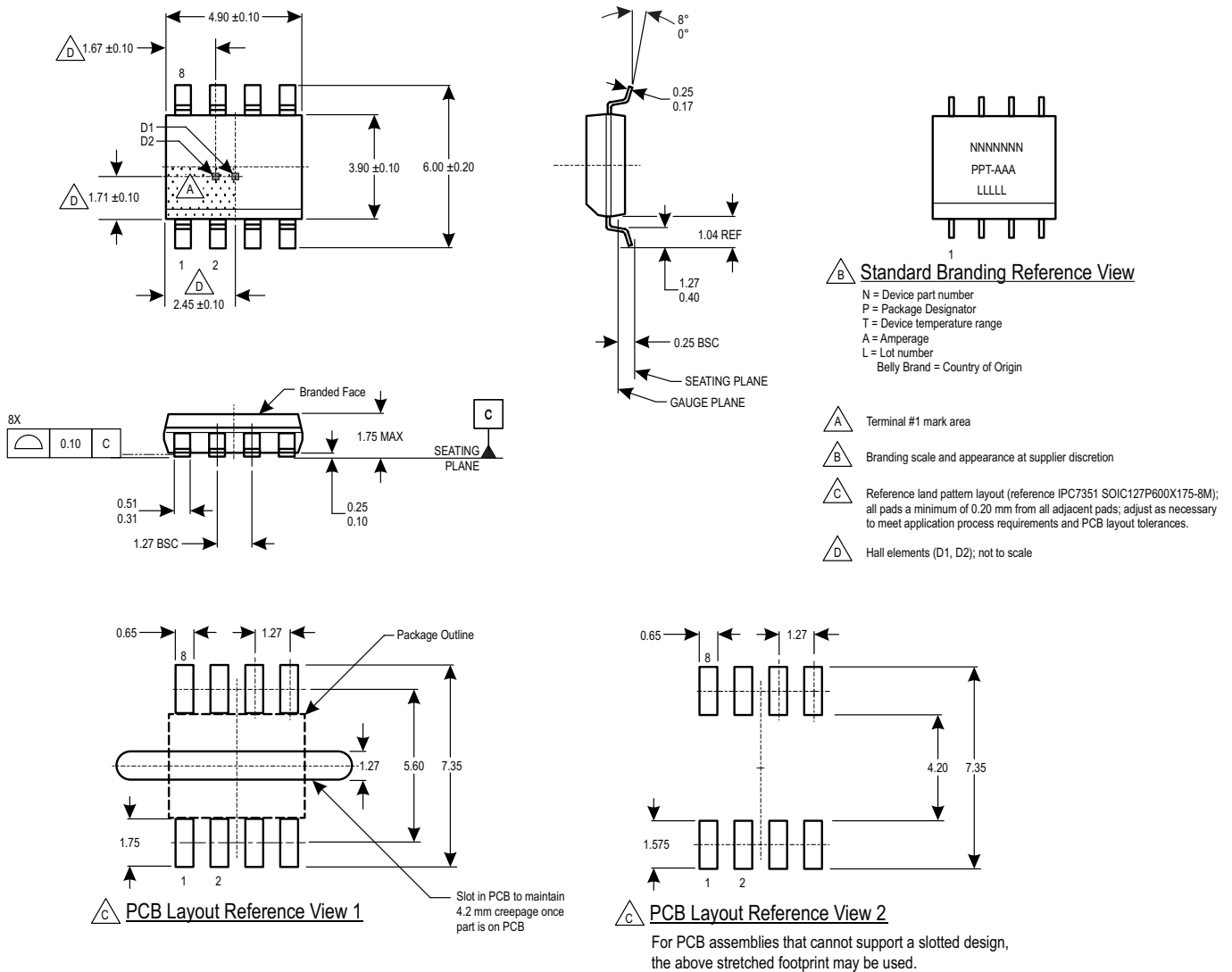

Figure 7: Package LC, 8-pin SOICN

Revision History

Number	Description	Pages	Responsible	Date
–	Added Characteristic Performance graphs and Application Information to Preliminary draft to create Final draft	All	A. Latham	January 16, 2015
1	Corrected Features and Benefits	2	A. Latham	June 19, 2015
2	Added ACS724LLCTR-50AB-T variant with electrical characteristics	2, 9	A. Latham	June 23, 2015
3	Corrected Characteristic Performance graph legends; updated Lifetime Drift Characteristics and added Error Over Lifetime electrical characteristics	6-18	A. Latham, S. Milano	August 12, 2015
4	Added ACS724LLCTR-05AB-T variant with electrical characteristics	2, 6	W. Bussing	August 8, 2016
5	Added AEC-Q100 qualified status	1	W. Bussing	June 28, 2017
6	Added ACS724LLCTR-05AB-T and ACS724LLCTR-50AB-T Characteristic Performance graphs	14, 21	W. Bussing	August 3, 2017
7	Updated Clearance and Creepage rating values	3	W. Bussing	January 10, 2018
8	Added Dielectric Surge Strength Test Voltage characteristic	2	W. Bussing	January 23, 2018
	Added Common Mode Field Rejection Ratio characteristic	5		
9	Added ACS724LLCTR-2P5AB-T variant with electrical characteristics	2, 6	W. Bussing	April 13, 2018
	Updated PCB Layout References in Package Outline Drawing	27		
10	Added Hall dimensions in Package Outline Drawing	27	W. Bussing	May 14, 2018
	Added ACS724LLCTR-40AU-T variant with electrical characteristics and performance graphs	2, 14, 23		
11	Added ACS724LLCTR-2P5AB-T performance graphs	16	M. McNally	June 22, 2018
	Added Typical Frequency Response plots	26	W. Bussing	
12	Added “Thermal Rise vs. Primary Current” and “ASEK724/5 Evaluation Board Layout” to the Applications Information section	28	W. Bussing	July 3, 2018
13	Corrected ACS724LLCTR-40AU-T Total Output Error and Sensitivity Error values	14	M. McNally	November 15, 2018
14	Updated certificate numbers	1	V. Mach	December 13, 2018
15	Updated TUV certificate mark	1	M. McNally	June 3, 2019
16	Added Maximum Current value to Absolute Maximum Ratings table; added ESD Ratings Table; updated Isolation Characteristics Table; updated Rise Time, Response Time, Propagation Delay, and Output Slew Rate test conditions; added Primary Conductor Inductance and Output Slew Rate values; added Typical Frequency Response application page; added Response Characteristics Definitions and Performance Data; added Power On Functional Description and Performance Data; added thermal data section; corrected Voltage Offset to Voltage Offset Error	All	K. Hampton	April 3, 2020
17	Updated Functional Block Diagram	4	K. Hampton	February 1, 2021
18	Removed Maximum Continuous Current from Absolute Maximum Ratings table; added -S lead free part variants; updated Common Electrical Characteristics table	All	K. Hampton	July 20, 2021
19	Added ACS724LLCTR-05AU-T and ACS724LLCTR-05AU-S variant with electrical characteristics	3, 8	K. Hampton	August 2, 2021
20	Removed Advanced designation from lead free part variants; removed ESD Ratings table; removed ACS724LLCTR-40AU-T part variant; minor editorial edits	3	K. Hampton	April 14, 2022
21	Merged Selection Guide tables	2	K. Hampton	May 18, 2022

Copyright 2022, Allegro MicroSystems.

Allegro MicroSystems reserves the right to make, from time to time, such departures from the detail specifications as may be required to permit improvements in the performance, reliability, or manufacturability of its products. Before placing an order, the user is cautioned to verify that the information being relied upon is current.

Allegro's products are not to be used in any devices or systems, including but not limited to life support devices or systems, in which a failure of Allegro's product can reasonably be expected to cause bodily harm.

The information included herein is believed to be accurate and reliable. However, Allegro MicroSystems assumes no responsibility for its use; nor for any infringement of patents or other rights of third parties which may result from its use.

Copies of this document are considered uncontrolled documents.

For the latest version of this document, visit our website:

www.allegromicro.com