

**790-036P**  
**Right Angle PCB Terminated**  
**Panel Mount Receptacle, Pin Contacts**  
**How To Order**



Series 79  
 90° PCB  
 Connectors

**790-036P Right Angle PCB Panel Mount Receptacles**  
**PIN CONTACTS WITH RIGHT ANGLE PCB TERMINATION**



Lightweight, rugged right angle headers feature gold-plated contacts for thru-hole printed circuit board termination. 790-036P connectors are designed for rear-panel mounting and are supplied with conductive panel gaskets. Contacts are permanently installed and are sealed with epoxy. Shells are aluminum alloy. Threaded board mounting holes and integral standoffs simplify installation. EMI shroud improves EMI performance. Fluorosilicone face seal provides watertight interface. Available in 29 different contact arrangements, these connectors feature size #23 signal contacts along with #16 and #12 power contacts for up to 23 amps current rating.

**HOW TO ORDER**

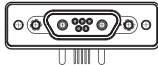
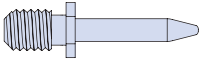
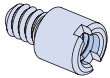
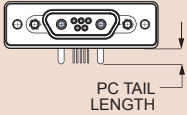
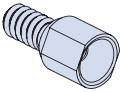
Sample Part Number				
790-036P	D-7P2	MT	P	A
Part Number	Shell Size - Insert Arrangements	Shell Finish	Hardware Option	PC Tail Length
<b>790-036P</b> Rear-Panel Mounted Receptacle with 90° PC Tail Pin Contacts for Termination to Backplanes or Flexible Circuits	See Table 1 for Available Insert Arrangements	<b>M</b> Electroless Nickel <i>general purpose applications</i>	 <b>N</b> No Hardware	<b>A</b> .125 Inch (3.2 mm.)
		<b>MT</b> Nickel-PTFE 1000 Hour Grey™ <i>maximum corrosion protection and durability (non-reflective grey)</i>	 <b>G</b> Guide Pin	<b>B</b> .250 inch (6.4 mm.)
		<b>ZNU</b> Zinc-Nickel with Black Chromate <i>tactical applications (non-reflective black)</i>	 <b>P</b> Female Jackpost	 PC TAIL LENGTH
		Additional shell finishes are listed on page C-9.	 <b>S</b> Female Guide Socket	

**SPECIFICATIONS**

Current Rating	#23 5 AMPS, #16 13 A., #12 23 A.
Dielectric Withstanding Voltage	#23 500 VAC RMS, #12 and #16 1800 VAC RMS
Insulation Resistance	5000 megohms minimum
Operating Temperature	-65° C. to +150° C.
Shock	300 g.
Vibration	37 g.

**MATERIALS AND FINISHES**

Shell	Aluminum alloy
Contacts	Copper alloy, 50 microinches gold plated
Insulator	Liquid crystal polymer (LCP)
Interfacial Seal	Fluorosilicone rubber
Hardware	300 series stainless steel
Panel Gasket	Fluorosilicone, conductive
Encapsulant	Epoxy

Dimensions in Inches (millimeters) are subject to change without notice.



# 790-036P Right Angle PCB Terminated Panel Mount Receptacle, Pin Contacts How To Order

Table I Contact Arrangements

Layout	Contact Quantity			Face View
	#23	#16	#12	
A-5	5			
B-2P2	2			
B-9	9			
C-13	13			
D-15	15			
D-3P3	3			
D-7P2	5	2		
E-11P2	9	2		
E-19	19			
E-7P3	4	3		
F-15P2	13	2		
F-23	23			
F-5P5	5			
G-33	33			
H-10P4	6	4		
H-29P7	22	7		
H-36P2	34	2		
H-54P2	52	2		
H-5P5		5		
H-66	66			
J-17P4	13	4		
J-25P2	23	2		
J-33	33			
J-7P7	7			
K-27P4	23	4		
K-35P2	33	2		
K-43	43			
K-9P9	9			
L-6P6		6		
L-78	78			
M-102	102			

CROSS-SECTIONAL VIEW OF 790-036P

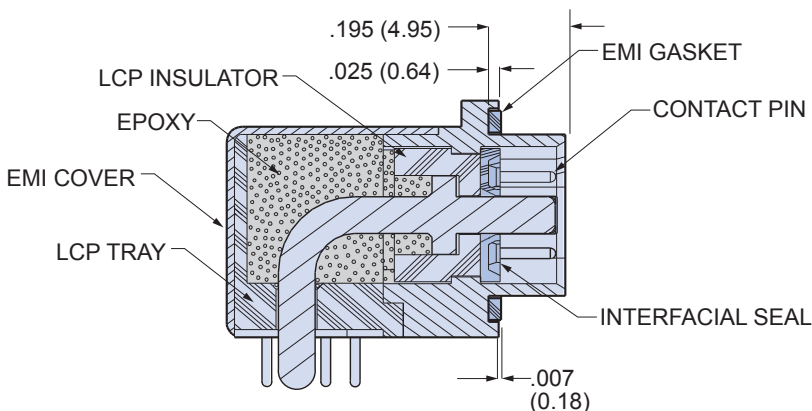
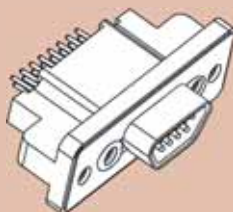

TABLE 2  
HARDWARE OPTION



**N**

**No Mating Hardware**

Connector is supplied with blind, tapped holes. Shell sizes H and L have 6-32 UNC-2B thread, other sizes are #4-40. Minimum thread depth is .150" (3.81).

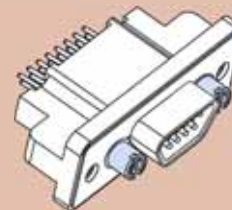

**P**

**Jackposts**

Connector is supplied with non-removable jackposts. Shell sizes H and L have #4-40 UNC-2B thread, other sizes have #2-56 thread.

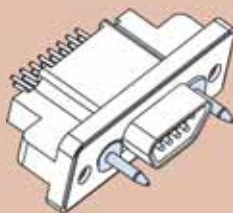

**G**

**Male Guide Pins**

Connector is supplied with stainless steel guide pins to mate with code S guide sockets. Pins are non-removable.

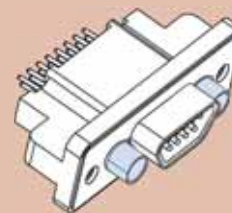

**S**

**Female Guide Sockets**

Connector is supplied with stainless steel guide sockets to mate with code G guide pins. Sockets are non-removable.

Dimensions in Inches (millimeters) are subject to change without notice.

**790-036P**  
**Right Angle PCB Terminated**  
**Panel Mount Receptacle, Pin Contacts**  
**Dimensions**



Series 79  
 90° PCB  
 Connectors

**790-036P Shell Sizes A-F, J and K Dimensions**

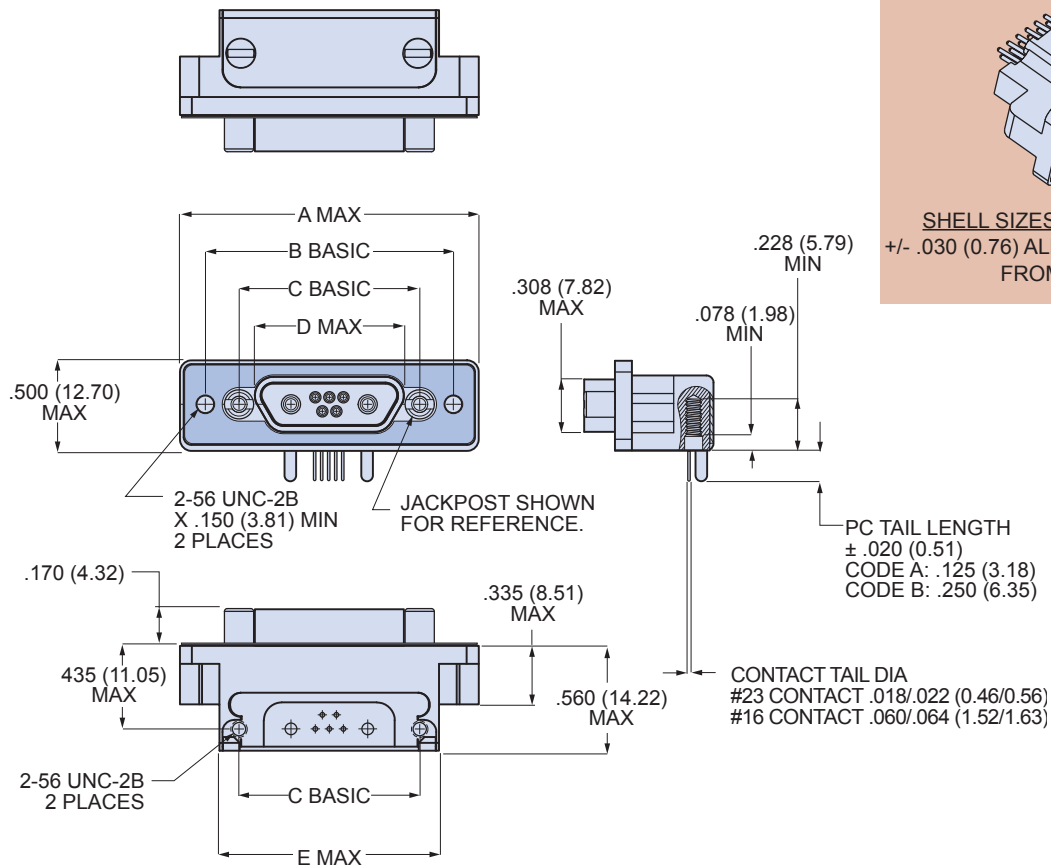

**BLIND MATE**

SHELL SIZES A, B, C, D, E, F, G, J, K  
 +/- .030 (0.76) ALLOWABLE MISALIGNMENT  
 FROM CENTERLINE

790-036P SHELL SIZES A-F, J AND K										
Shell Size	A Max.		B Basic		C Basic		D Max.		E Max.	
	In.	mm.	In.	mm.	In.	mm.	In.	mm.	In.	mm.
A	1.211	30.76	.925	23.50	.565	14.35	.401	10.19	.805	20.45
B	1.361	34.57	1.075	27.31	.715	18.16	.551	14.00	.955	24.26
C	1.511	38.38	1.225	31.12	.865	21.97	.701	17.81	1.105	28.07
D	1.611	40.92	1.325	33.66	.965	24.51	.801	20.35	1.205	30.61
E	1.761	44.73	1.475	37.47	1.115	28.32	.951	24.16	1.355	34.42
F	1.911	48.54	1.625	41.28	1.265	32.13	1.101	27.96	1.505	38.23
J	2.261	57.43	1.975	50.17	1.615	41.02	1.460	37.08	1.855	47.12
K	2.661	67.59	2.375	60.33	2.015	51.18	1.860	47.24	2.255	57.28

Dimensions in Inches (millimeters) are subject to change without notice.





**790-036P**  
Right Angle PCB Terminated  
Panel Mount Receptacle, Pin Contacts  
Dimensions

**790-036P Shell Size G Dimensions**

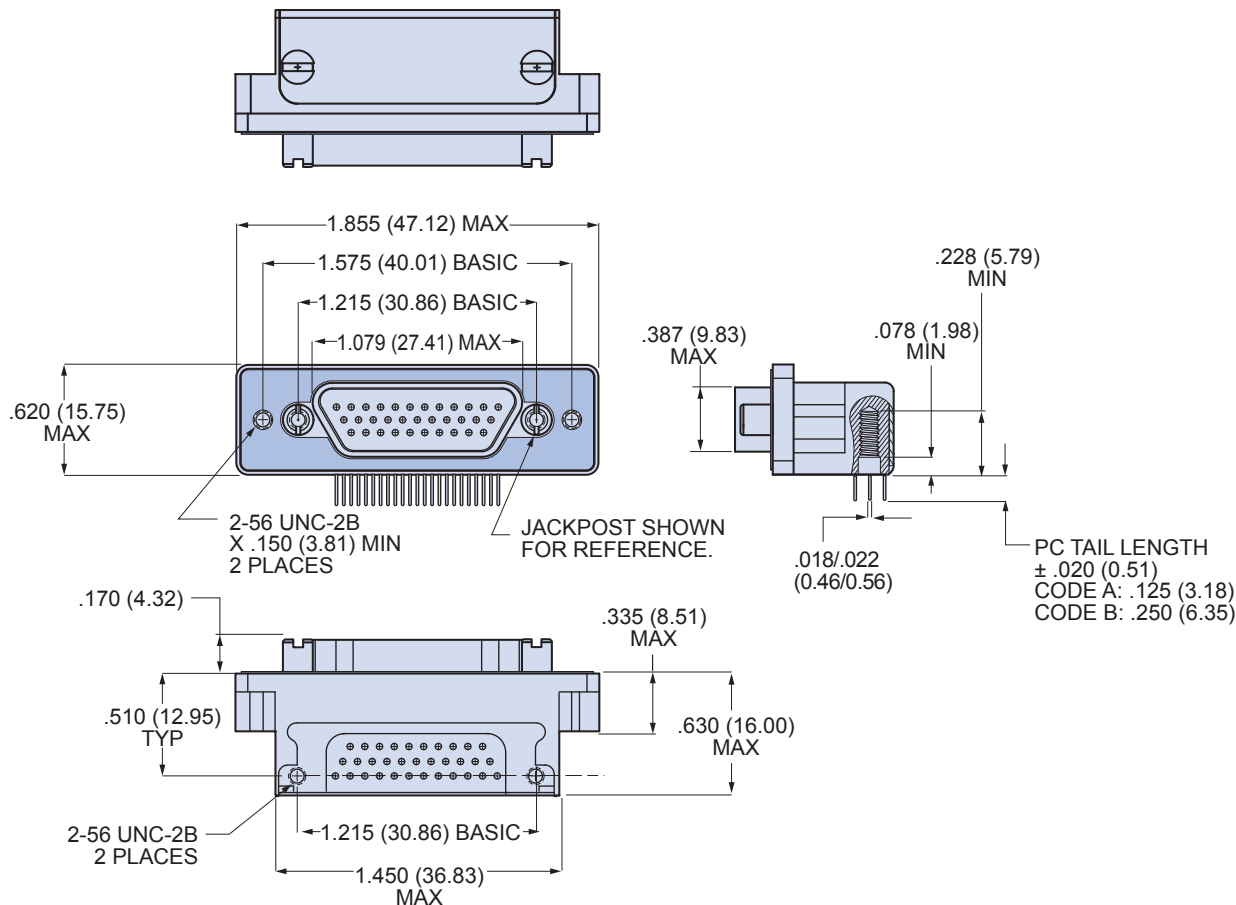

**BLIND MATE**

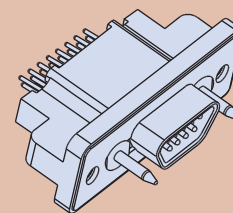

SHELL SIZES A, B, C, D, E, F, G, J, K  
+/- .030 (0.76) ALLOWABLE MISALIGNMENT  
FROM CENTERLINE

Dimensions in Inches (millimeters) are subject to change without notice.

# 790-036P Right Angle PCB Terminated Panel Mount Receptacle, Pin Contacts Dimensions



Series 79  
90° PCB  
Connectors

## 790-036P Shell Sizes H and L Dimensions

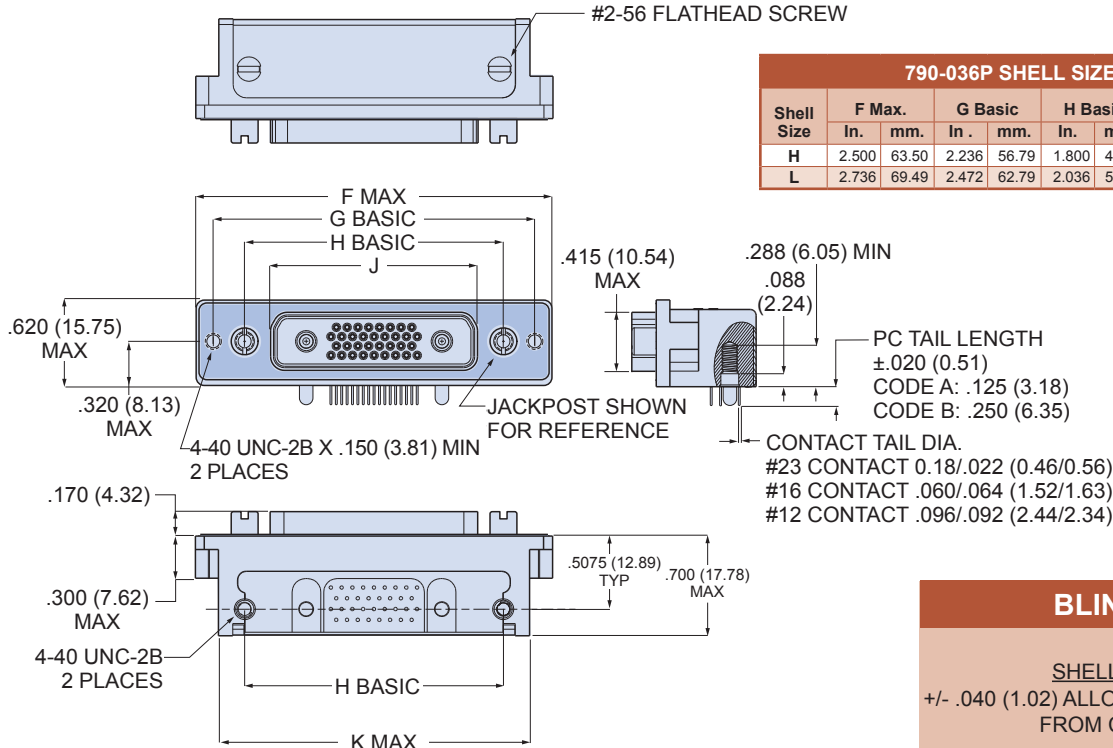

**BLIND MATE**

SHELL SIZES H, L  
+/- .040 (1.02) ALLOWABLE MISALIGNMENT FROM CENTERLINE

## 790-036P Shell Size M Dimensions

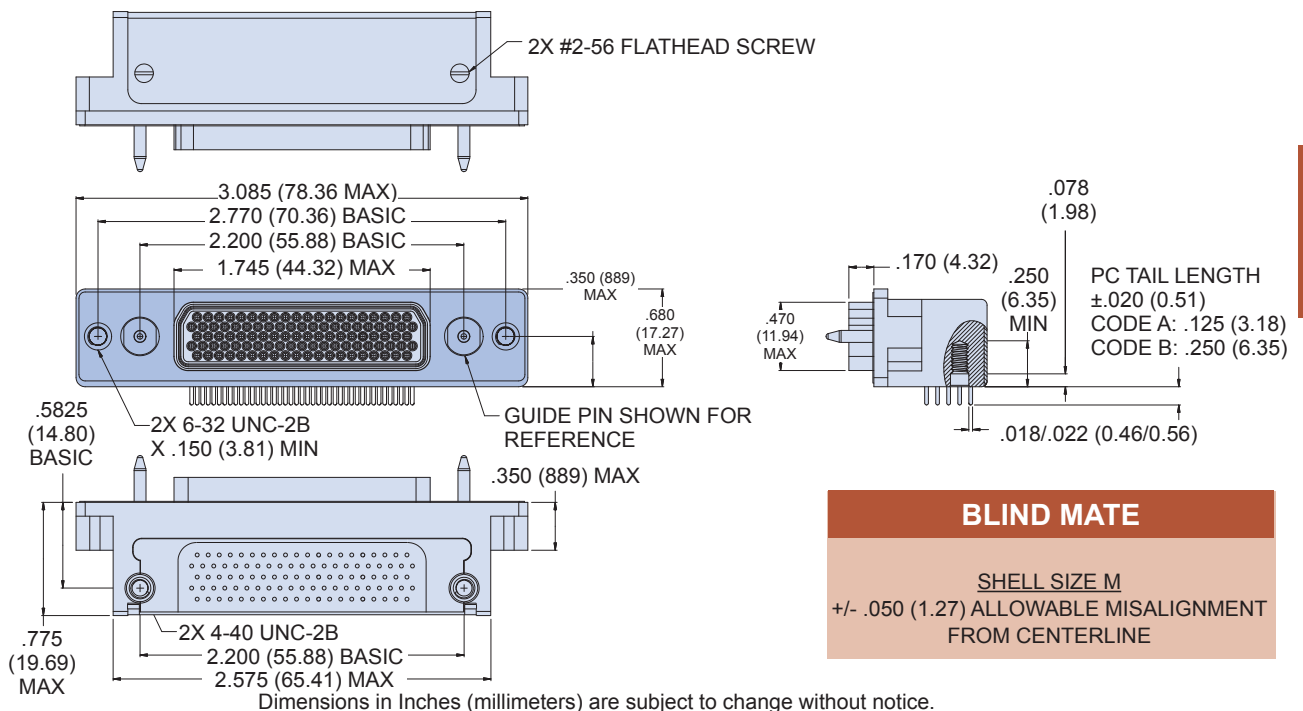

**BLIND MATE**

SHELL SIZE M  
+/- .050 (1.27) ALLOWABLE MISALIGNMENT FROM CENTERLINE

Dimensions in Inches (millimeters) are subject to change without notice.

# Mouser Electronics

Authorized Distributor

Click to View Pricing, Inventory, Delivery & Lifecycle Information:

[Glenair:](#)

[790-036PB-9MPA](#) [790-036PB-9MGA](#) [790-036PH-66MTPA](#) [790-036PM-102MSA](#) [790036PJ-33MTPA](#) [790-036PJ-33MTPA](#)