



CAMBLOCK

PCB
TERMINAL
BLOCKS

5.08mm Pitch Pluggable Rising Clamp Terminal

- 2-24 pole solid block
- Pluggable male-female connectors
- Open & closed headers
- Horizontal & vertical female plug styles
- Polarised mouldings
- Moulded in green UL94-V0 flame retardant PA66
- Professional rising clamp terminals
- 0.33-2mm² (22-14AWG) solid & stranded cable
- Captive screws
- Guided pin alignment
-   approved

SPECIFICATION

Rating	15A 300V
Insulation resistance	1000MΩ/1000V
Withstand Voltage	AC1500V/1min
Contact Resistance	20mΩ
Working Temperature	-40°C to +105°C
Mouldings	UL94-V0 flame retardant PA66
Pin/Terminal	Tin plated brass
Screw/Torque	M2.5 Steel, Nickel Plated 0.4Nm
Recommended PCB hole size	ø1.7mm

Female Connector

TYPE NO.	POLES	LENGTH	TYPE NO.	POLES	LENGTH
CTB9209/2	2	10.2mm	CTB9209/14	14	71.1mm
CTB9209/3	3	15.2mm	CTB9209/15	15	76.2mm
CTB9209/4	4	20.3mm	CTB9209/16	16	81.3mm
CTB9209/5	5	25.4mm	CTB9209/17	17	86.4mm
CTB9209/6	6	30.5mm	CTB9209/18	18	91.4mm
CTB9209/7	7	35.6mm	CTB9209/19	19	96.5mm
CTB9209/8	8	40.6mm	CTB9209/20	20	101.6mm
CTB9209/9	9	45.7mm	CTB9209/21	21	106.7mm
CTB9209/10	10	50.8mm	CTB9209/22	22	111.8mm
CTB9209/11	11	55.9mm	CTB9209/23	23	116.8mm
CTB9209/12	12	61mm	CTB9209/24	24	121.9mm
CTB9209/13	13	66mm			

CTB9209

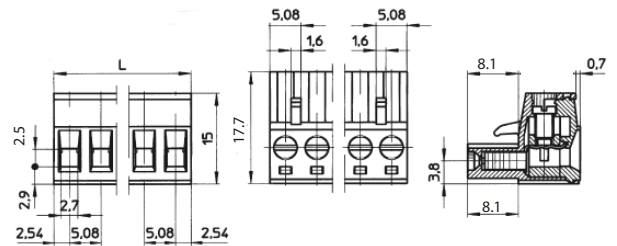

Female Connector Vertical (standard)

TYPE NO.	POLES	LENGTH	TYPE NO.	POLES	LENGTH
CTB922VJ/2S	2	10.2mm	CTB922VJ/14S	14	71.1mm
CTB922VJ/3S	3	15.2mm	CTB922VJ/15S	15	76.2mm
CTB922VJ/4S	4	20.3mm	CTB922VJ/16S	16	81.3mm
CTB922VJ/5S	5	25.4mm	CTB922VJ/17S	17	86.4mm
CTB922VJ/6S	6	30.5mm	CTB922VJ/18S	18	91.4mm
CTB922VJ/7S	7	35.6mm	CTB922VJ/19S	19	96.5mm
CTB922VJ/8S	8	40.6mm	CTB922VJ/20S	20	101.6mm
CTB922VJ/9S	9	45.7mm	CTB922VJ/21S	21	106.7mm
CTB922VJ/10S	10	50.8mm	CTB922VJ/22S	22	111.8mm
CTB922VJ/11S	11	55.9mm	CTB922VJ/23S	23	116.8mm
CTB922VJ/12S	12	61mm	CTB922VJ/24S	24	121.9mm
CTB922VJ/13S	13	66mm			

CTB922VJ/S

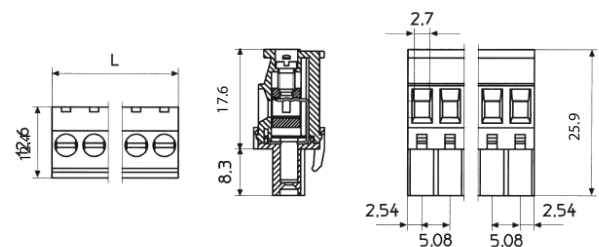

CAMBLOCK

Female Connector Vertical (reversed)

TYPE NO.	POLES	LENGTH
CTB922VJ/2R	2	10.2mm
CTB922VJ/3R	3	15.2mm
CTB922VJ/4R	4	20.3mm
CTB922VJ/5R	5	25.4mm
CTB922VJ/6R	6	30.5mm
CTB922VJ/7R	7	35.6mm
CTB922VJ/8R	8	40.6mm
CTB922VJ/9R	9	45.7mm
CTB922VJ/10R	10	50.8mm
CTB922VJ/11R	11	55.9mm
CTB922VJ/12R	12	61mm
CTB922VJ/13R	13	66mm
CTB922VJ/14R	14	71.1mm
CTB922VJ/15R	15	76.2mm
CTB922VJ/16R	16	81.3mm
CTB922VJ/17R	17	86.4mm
CTB922VJ/18R	18	91.4mm
CTB922VJ/19R	19	96.5mm
CTB922VJ/20R	20	101.6mm
CTB922VJ/21R	21	106.7mm
CTB922VJ/22R	22	111.8mm
CTB922VJ/23R	23	116.8mm
CTB922VJ/24R	24	121.9mm

CTB922VJ/R

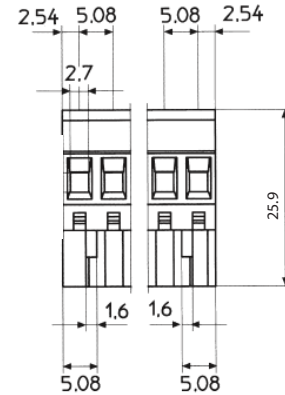
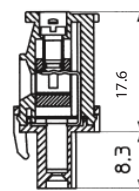
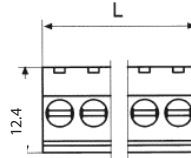

PCB Mounting Male Vertical (closed end)

TYPE NO.	POLES	LENGTH
CTB9309/2	2	11.4mm
CTB9309/3	3	16.4mm
CTB9309/4	4	21.5mm
CTB9309/5	5	26.6mm
CTB9309/6	6	31.7mm
CTB9309/7	7	36.78mm
CTB9309/8	8	41.8mm
CTB9309/9	9	46.9mm
CTB9309/10	10	52mm
CTB9309/11	11	57.1mm
CTB9309/12	12	62.3mm
CTB9309/13	13	67.2mm
CTB9309/14	14	72.3mm
CTB9309/15	15	77.4mm
CTB9309/16	16	82.5mm
CTB9309/17	17	87.6mm
CTB9309/18	18	92.6mm
CTB9309/19	19	97.7mm
CTB9309/20	20	102.8mm
CTB9309/21	21	107.9mm
CTB9309/22	22	113mm
CTB9309/23	23	118mm
CTB9309/24	24	123.1mm

CTB9309

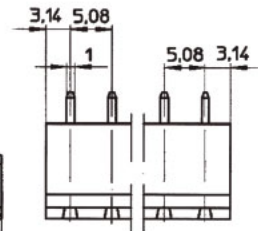
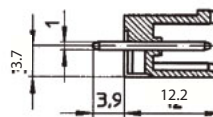
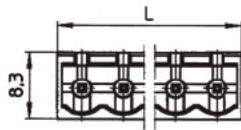

CAMBLOCK

PCB
TERMINAL
BLOCKS

PCB Mounting Male Horizontal (closed end)

TYPE NO.	POLES	LENGTH	CTB9359
CTB9359/2	2	11.4mm	
CTB9359/3	3	16.4mm	
CTB9359/4	4	21.5mm	
CTB9359/5	5	26.6mm	
CTB9359/6	6	31.7mm	
CTB9359/7	7	36.78mm	
CTB9359/8	8	41.8mm	
CTB9359/9	9	46.9mm	
CTB9359/10	10	52mm	
CTB9359/11	11	57.1mm	
CTB9359/12	12	62.3mm	
CTB9359/13	13	67.2mm	
CTB9359/14	14	72.3mm	
CTB9359/15	15	77.4mm	
CTB9359/16	16	82.5mm	
CTB9359/17	17	87.6mm	
CTB9359/18	18	92.6mm	
CTB9359/19	19	97.7mm	
CTB9359/20	20	102.8mm	
CTB9359/21	21	107.9mm	
CTB9359/22	22	113mm	
CTB9359/23	23	118mm	
CTB9359/24	24	123.1mm	

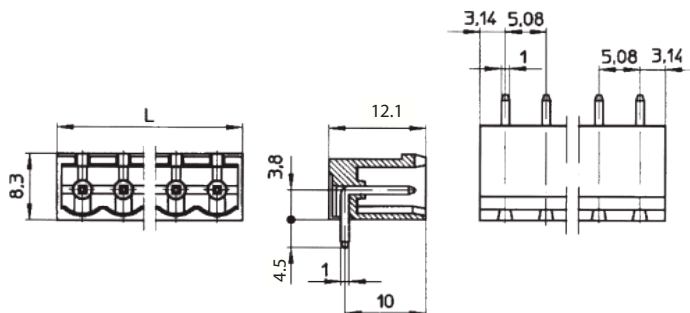

PCB Mounting Male Vertical (open ended)

TYPE NO.	POLES	LENGTH	CTB9309/AO
CTB9309/2AO	2	10.2mm	
CTB9309/3AO	3	15.2mm	
CTB9309/4AO	4	20.3mm	
CTB9309/5AO	5	25.4mm	
CTB9309/6AO	6	30.5mm	
CTB9309/7AO	7	35.6mm	
CTB9309/8AO	8	40.6mm	
CTB9309/9AO	9	45.7mm	
CTB9309/10AO	10	50.8mm	
CTB9309/11AO	11	55.9mm	
CTB9309/12AO	12	61mm	
CTB9309/13AO	13	66mm	
CTB9309/14AO	14	71.1mm	
CTB9309/15AO	15	76.2mm	
CTB9309/16AO	16	81.3mm	
CTB9309/17AO	17	86.4mm	
CTB9309/18AO	18	91.4mm	
CTB9309/19AO	19	96.5mm	
CTB9309/20AO	20	101.6mm	
CTB9309/21AO	21	106.7mm	
CTB9309/22AO	22	111.7mm	
CTB9309/23AO	23	116.8mm	
CTB9309/24AO	24	121.9mm	

