

International
IR Rectifier

QUIETIR Series 10ETF..FP

FAST SOFT RECOVERY RECTIFIER DIODE

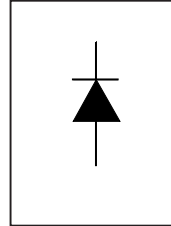

$$V_F < 1.33V @ 10A$$

$$t_{rr} = 80ns$$

$$V_{RRM} 1000, 1200V$$

Description/ Features

The 10ETF..FP fast soft recovery *QUIETIR* rectifier series has been optimized for combined short reverse recovery time and low forward voltage drop.

The glass passivation ensures stable reliable operation in the most severe temperature and power cycling conditions.

Typical applications are both:

- output rectification and freewheeling in inverters, choppers and converters
- and input rectifications where severe restrictions on conducted EMI should be met.

Major Ratings and Characteristics

Characteristics	10ETF..FP	Units
$I_{F(AV)}$ Sinusoidal waveform	10	A
V_{RRM}	1000 to 1200	V
I_{FSM}	160	A
V_F @ 10 A, $T_J = 25^\circ C$	1.33	V
t_{rr} @ 1 A, 100 A/ μs	80	ns
T_J	-40 to 150	$^\circ C$

Package Outline

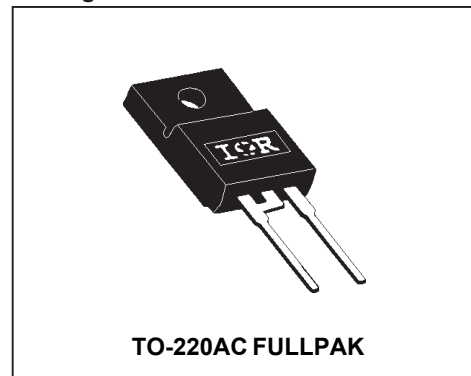

Voltage Ratings

Part Number	V_{RRM} , maximum peak reverse voltage V	V_{RSM} , maximum non repetitive peak reverse voltage V	I_{RRM} 150°C mA
10ETF10FP	1000	1100	4
10ETF12FP	1200	1300	

Absolute Maximum Ratings

Parameters	10ETF..FP	Units	Conditions
$I_{F(AV)}$ Max. Average Forward Current	10	A	@ $T_C = 95^\circ\text{C}$, 180° conduction half sine wave
I_{FSM} Max. Peak One Cycle Non-Repetitive Surge Current	160	A	10ms Sine pulse, rated V_{RRM} applied
	185		10ms Sine pulse, no voltage reapplied
I^2t Max. I^2t for fusing	128	A^2s	10ms Sine pulse, rated V_{RRM} applied
	180		10ms Sine pulse, no voltage reapplied
$I^2\sqrt{t}$ Max. $I^2\sqrt{t}$ for fusing	1800	$A^2\sqrt{s}$	$t = 0.1$ to 10ms, no voltage reapplied

Electrical Specifications

Parameters	10ETF..FP	Units	Conditions
V_{FM} Max. Forward Voltage Drop	1.33	V	@ 10A, $T_J = 25^\circ\text{C}$
r_t Forward slope resistance	22.9	$m\Omega$	$T_J = 150^\circ\text{C}$
$V_{F(TO)}$ Threshold voltage	0.96	V	
I_{RM} Max. Reverse Leakage Current	0.1	mA	$T_J = 25^\circ\text{C}$
	4		$T_J = 150^\circ\text{C}$

$V_R = \text{rated } V_{RRM}$

Recovery Characteristics

Parameters	10ETF..FP	Units	Conditions
t_{rr} Reverse Recovery Time	310	ns	$I_F @ 10\text{Apk}$
I_{rr} Reverse Recovery Current	4.7	A	@ 25A/ μs
Q_{rr} Reverse Recovery Charge	1.05	μC	@ 25°C
S Typical Snap Factor	0.6		

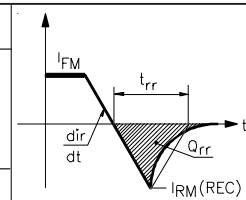

Thermal-Mechanical Specifications

Parameters		10ETF..FP	Units	Conditions
T_J	Max. Junction Temperature Range	-40 to 150	°C	
T_{stg}	Max. Storage Temperature Range	-40 to 150	°C	
R_{thJC}	Max. Thermal Resistance Junction to Case	2.5	°C/W	DC operation
R_{thJA}	Max. Thermal Resistance Junction to Ambient	62	°C/W	
R_{thCS}	Typical Thermal Resistance, Case to Heatsink	0.5	°C/W	Mounting surface , smooth and greased
wt	Approximate Weight	2 (0.07)	g (oz.)	
T	Mounting Torque	Min.	6 (5)	Kg-cm (lbf-in)
		Max.	12 (10)	
Case Style		TO-220AC FULLPAK	JEDEC	

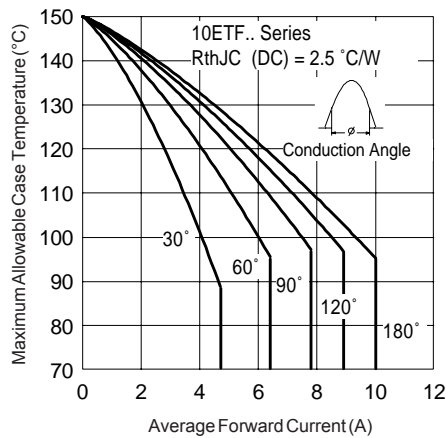

Fig. 1 - Current Rating Characteristics

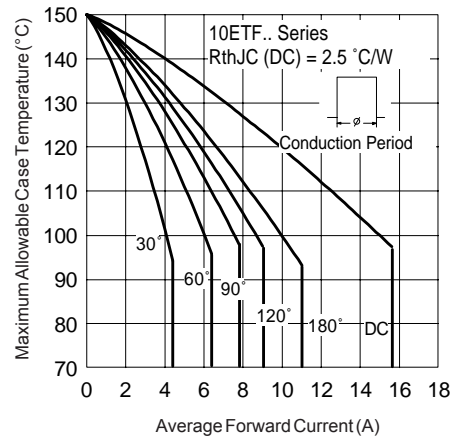

Fig. 2 - Current Rating Characteristics

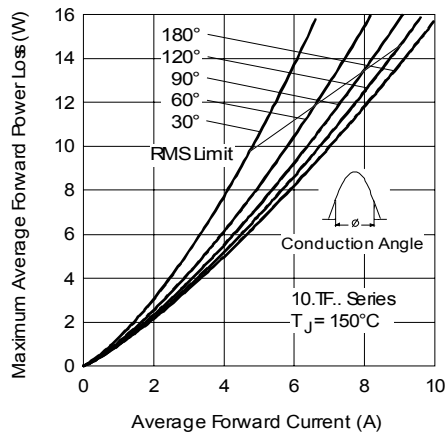

Fig. 3 - Forward Power Loss Characteristics

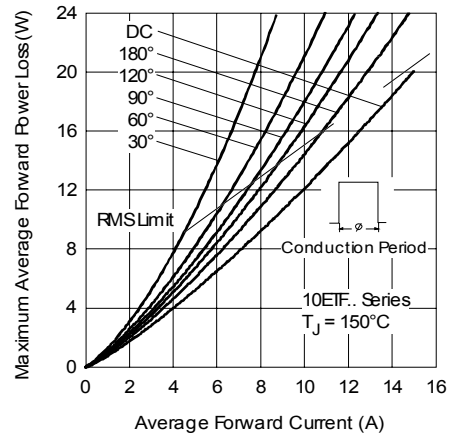

Fig. 4 - Forward Power Loss Characteristics

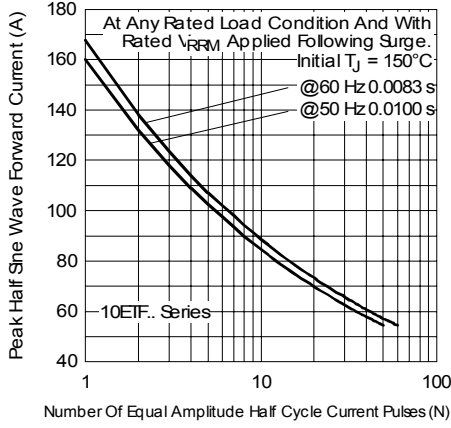

Fig. 5 - Maximum Non-Repetitive Surge Current

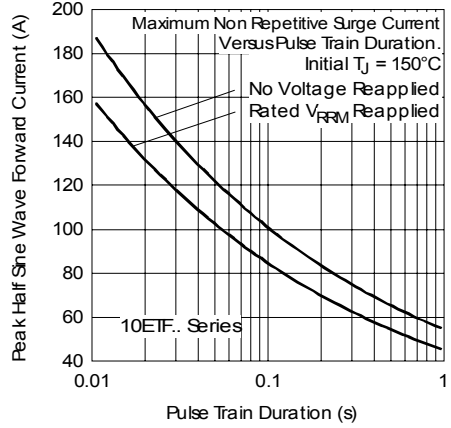

Fig. 6 - Maximum Non-Repetitive Surge Current

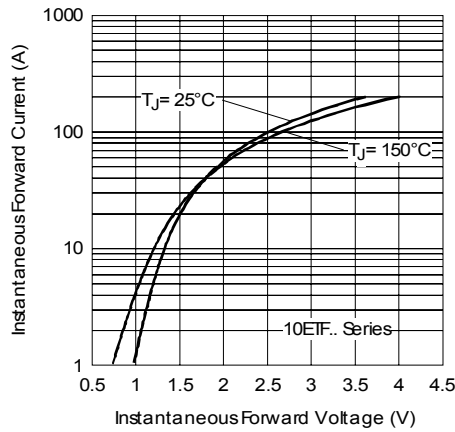

Fig. 7 - Forward Voltage Drop Characteristics

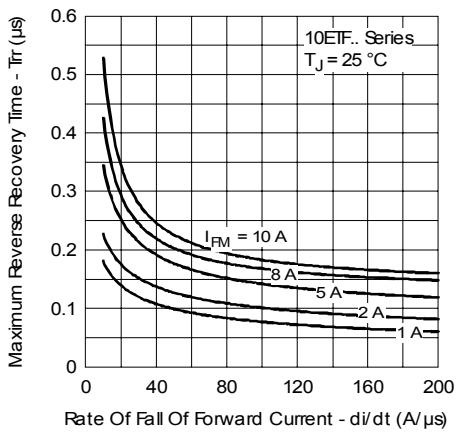

Fig. 8 - Recovery Time Characteristics, $T_J = 25^\circ\text{C}$

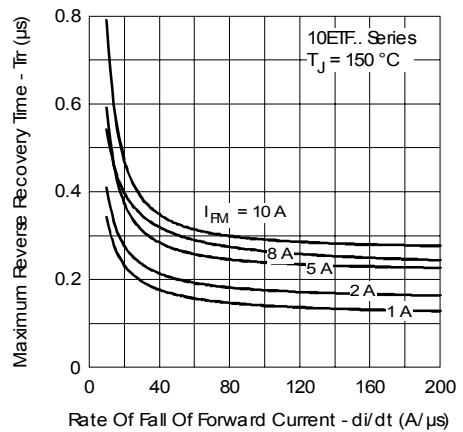

Fig. 9 - Recovery Time Characteristics, $T_J = 150^\circ\text{C}$

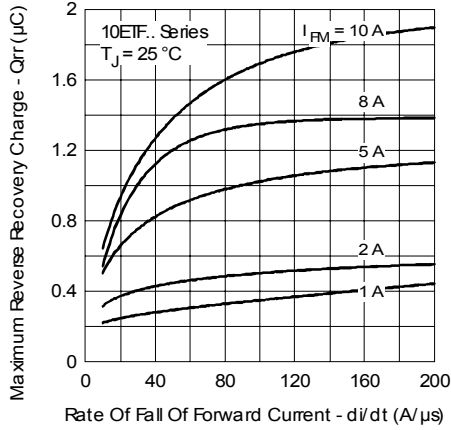

Fig. 10 - Recovery Charge Characteristics, $T_J = 25^\circ\text{C}$

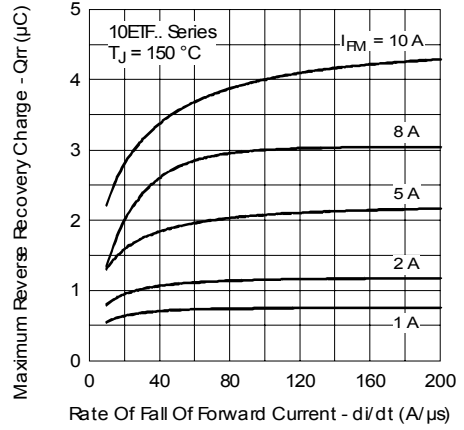

Fig. 11 - Recovery Charge Characteristics, $T_J = 150^\circ\text{C}$

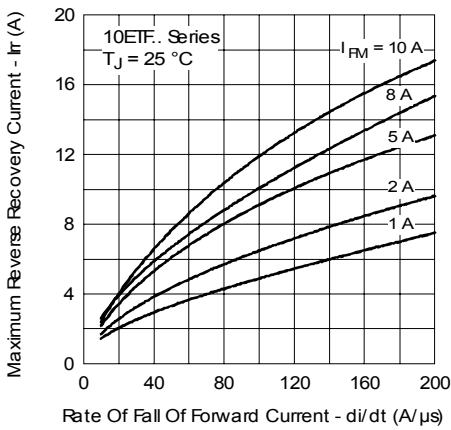

Fig. 12 - Recovery Current Characteristics, $T_J = 25^\circ\text{C}$

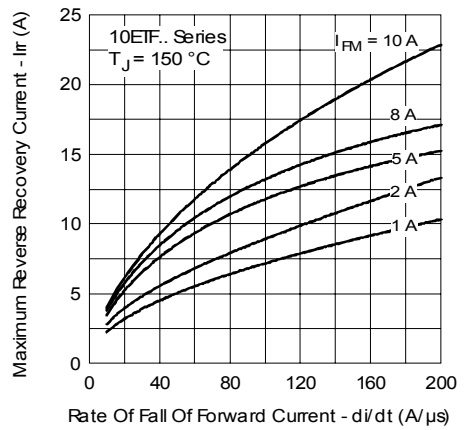

Fig. 13 - Recovery Current Characteristics, $T_J = 150^\circ\text{C}$

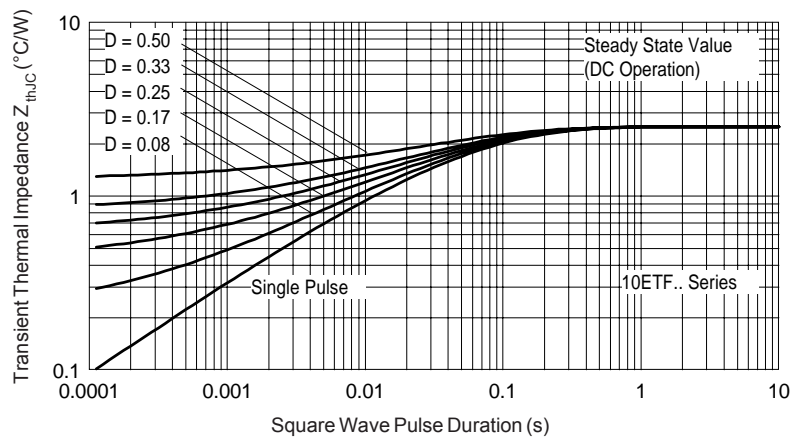

Fig. 14 - Thermal Impedance Z_{thJC} Characteristics

10ETF..FP QUIETIR Series

Bulletin I2165 06/03

International
IR Rectifier

Outline Table

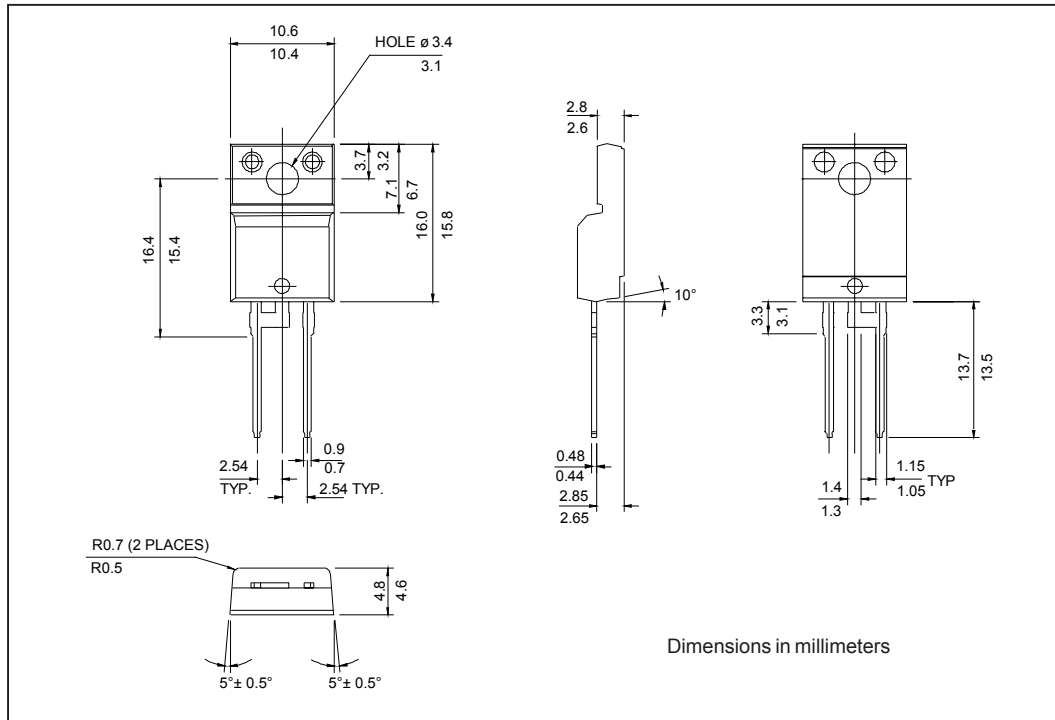

Ordering Information Table

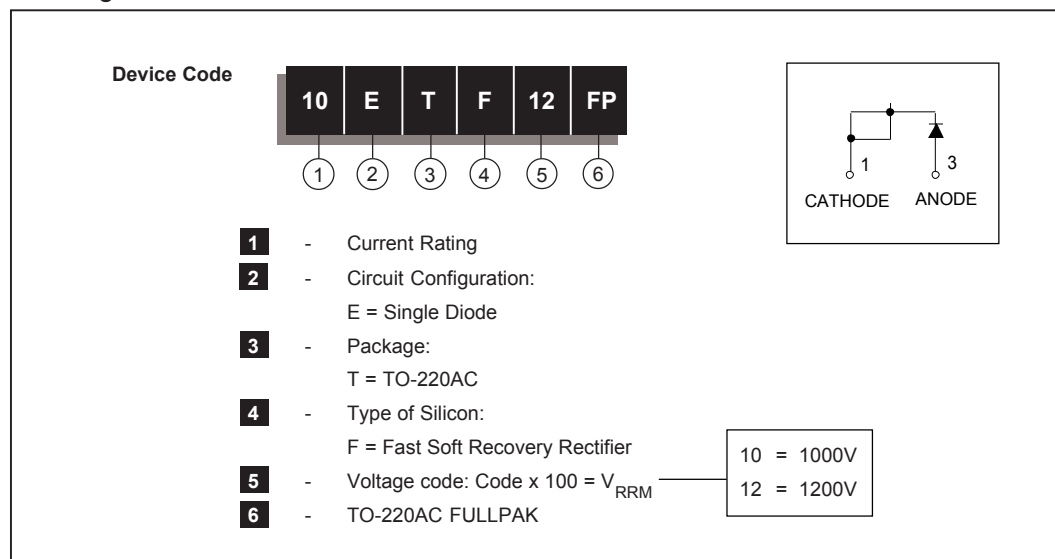

Data and specifications subject to change without notice.
This product has been designed and qualified for Industrial Level.
Qualification Standards can be found on IR's Web site.

International
IOR Rectifier

IR WORLD HEADQUARTERS: 233 Kansas St., El Segundo, California 90245, USA Tel: (310) 252-7105
TAC Fax: (310) 252-7309
Visit us at www.irf.com for sales contact information. 06/03

This datasheet has been download from:

www.datasheetcatalog.com

Datasheets for electronics components.