



## 2.5GHz 45dB RF-Detecting Controllers

### General Description

The MAX4000/MAX4001/MAX4002 low-cost, low-power logarithmic amplifiers are designed to control RF power amplifiers (PA) operating in the 0.1GHz to 2.5GHz frequency range. A typical dynamic range of 45dB makes this family of log amps useful in a variety of wireless applications including cellular handset PA control, transmitter power measurement, and RSSI for terminal devices. Logarithmic amplifiers provide much wider measurement range and superior accuracy to controllers based on diode detectors. Excellent temperature stability is achieved over the full operating range of -40°C to +85°C.

The choice of three different input voltage ranges eliminates the need for external attenuators, thus simplifying PA control-loop design. The logarithmic amplifier is a voltage-measuring device with a typical signal range of -58dBV to -13dBV for the MAX4000, -48dBV to -3dBV for the MAX4001, and -43dBV to +2dBV for the MAX4002.

The input signal for the MAX4000 is internally AC-coupled using an on-chip 5pF capacitor in series with a 2k $\Omega$  input resistance. This highpass coupling, with a corner at 16MHz, sets the lowest operating frequency and allows the input signal source to be DC grounded. The MAX4001/MAX4002 require an external coupling capacitor in series with the RF input port. These PA controllers feature a power-on delay when coming out of shutdown, holding OUT low for approximately 5 $\mu$ s to ensure glitch-free controller output.

The MAX4000/MAX4001/MAX4002 family is available in an 8-pin  $\mu$ MAX package and an 8-bump chip-scale package (UCSP™). The device consumes 5.9mA with a 5.5V supply, and when powered down the typical shutdown current is 13 $\mu$ A.

### Applications

Transmitter Power Measurement and Control  
 TSSI for Wireless Terminal Devices  
 Cellular Handsets (TDMA, CDMA, GPRS, GSM)  
 RSSI for Fiber Modules

UCSP is a registered trademark of Maxim Integrated Products, Inc.

### Features

- ◆ Complete RF-Detecting PA Controllers
- ◆ Variety of Input Ranges
  - MAX4000: -58dBV to -13dBV (-45dBm to 0dBm in 50 $\Omega$ )
  - MAX4001: -48dBV to -3dBV (-35dBm to +10dBm in 50 $\Omega$ )
  - MAX4002: -43dBV to +2dBV (-30dBm to +15dBm in 50 $\Omega$ )
- ◆ Frequency Range from 100MHz to 2.5GHz
- ◆ Temperature Stable Linear-in-dB Response
- ◆ Fast Response: 70ns 10dB Step
- ◆ 10mA Output Sourcing Capability
- ◆ Low Power: 17mW at 3V (typ)
- ◆ Shutdown Current 30 $\mu$ A (max)
- ◆ Available in an 8-Bump UCSP and a Small 8-Pin  $\mu$ MAX Package

### Ordering Information

| PART         | TEMP RANGE     | PIN-PACKAGE | TOP MARK |
|--------------|----------------|-------------|----------|
| MAX4000EBL-T | -40°C to +85°C | 8 UCSP-8    | ABF      |
| MAX4000EUA   | -40°C to +85°C | 8 $\mu$ MAX | —        |
| MAX4001EBL-T | -40°C to +85°C | 8 UCSP-8    | ABE      |
| MAX4001EUA   | -40°C to +85°C | 8 $\mu$ MAX | —        |
| MAX4002EBL-T | -40°C to +85°C | 8 UCSP-8    | ABD      |
| MAX4002EUA   | -40°C to +85°C | 8 $\mu$ MAX | —        |

Pin Configurations appear at end of data sheet.

### Functional Diagram

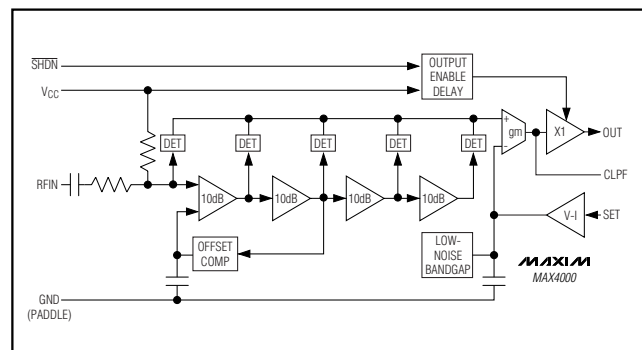

# 2.5GHz 45dB RF-Detecting Controllers

## ABSOLUTE MAXIMUM RATINGS

(Voltages Referenced to GND)

|                                                 |                                   |
|-------------------------------------------------|-----------------------------------|
| V <sub>CC</sub> .....                           | -0.3V to +6V                      |
| OUT, SET, $\overline{\text{SHDN}}$ , CLPF ..... | -0.3V to (V <sub>CC</sub> + 0.3V) |
| RFIN                                            |                                   |
| MAX4000 .....                                   | +6dBm                             |
| MAX4001 .....                                   | +16dBm                            |
| MAX4002 .....                                   | +19dBm                            |
| Equivalent Voltage                              |                                   |
| MAX4000 .....                                   | 0.45V <sub>RMS</sub>              |
| MAX4001 .....                                   | 1.4V <sub>RMS</sub>               |
| MAX4002 .....                                   | 2.0V <sub>RMS</sub>               |

|                                                       |                 |
|-------------------------------------------------------|-----------------|
| OUT Short Circuit to GND .....                        | Continuous      |
| Continuous Power Dissipation (T <sub>A</sub> = +70°C) |                 |
| 8-Bump UCSP (derate 4.7mW/°C above +70°C).....        | 379mW           |
| 8-Pin $\mu$ MAX (derate 4.5mW/°C above +70°C) .....   | 362mW           |
| Operating Temperature Range .....                     | -40°C to +85°C  |
| Storage Temperature Range .....                       | -65°C to +150°C |
| Lead Temperature (soldering , 10s) .....              | +300°C          |

Stresses beyond those listed under "Absolute Maximum Ratings" may cause permanent damage to the device. These are stress ratings only, and functional operation of the device at these or any other conditions beyond those indicated in the operational sections of the specifications is not implied. Exposure to absolute maximum rating conditions for extended periods may affect device reliability.

## ELECTRICAL CHARACTERISTICS

(V<sub>CC</sub> = 3V,  $\overline{\text{SHDN}}$  = 1.8V, T<sub>A</sub> = -40°C to +85°C, unless otherwise noted. Typical values are at T<sub>A</sub> = +25°C.) (Note 1)

| PARAMETER                              | SYMBOL            | CONDITIONS                                              | MIN  | TYP   | MAX  | UNITS                  |
|----------------------------------------|-------------------|---------------------------------------------------------|------|-------|------|------------------------|
| Supply Voltage                         | V <sub>CC</sub>   |                                                         | 2.7  |       | 5.5  | V                      |
| Supply Current                         | I <sub>CC</sub>   | V <sub>CC</sub> = 5.5V                                  |      | 5.9   | 9.3  | mA                     |
| Shutdown Supply Current                | I <sub>CC</sub>   | $\overline{\text{SHDN}}$ = 0.8V, V <sub>CC</sub> = 5.5V |      | 13    | 30   | $\mu$ A                |
| Shutdown Output Voltage                | V <sub>OUT</sub>  | $\overline{\text{SHDN}}$ = 0.8V                         |      | 100   |      | mV                     |
| Logic-High Threshold                   | V <sub>H</sub>    |                                                         | 1.8  |       |      | V                      |
| Logic-Low Threshold                    | V <sub>L</sub>    |                                                         |      |       | 0.8  | V                      |
| $\overline{\text{SHDN}}$ Input Current | I <sub>SHDN</sub> | $\overline{\text{SHDN}}$ = 3V                           |      | 5     | 20   | $\mu$ A                |
|                                        |                   | $\overline{\text{SHDN}}$ = 0                            | -0.8 | -0.01 |      |                        |
| <b>SET-POINT INPUT</b>                 |                   |                                                         |      |       |      |                        |
| Voltage Range (Note 2)                 | V <sub>SET</sub>  | Corresponding to central 40dB                           | 0.35 |       | 1.45 | V                      |
| Input Resistance                       | R <sub>IN</sub>   |                                                         |      | 30    |      | M $\Omega$             |
| Slew Rate (Note 3)                     |                   |                                                         |      | 16    |      | V/ $\mu$ s             |
| <b>MAIN OUTPUT</b>                     |                   |                                                         |      |       |      |                        |
| Voltage Range                          | V <sub>OUT</sub>  | High, I <sub>SOURCE</sub> = 10mA                        | 2.65 | 2.75  |      | V                      |
|                                        |                   | Low, I <sub>SINK</sub> = 350 $\mu$ A                    |      | 0.15  |      |                        |
| Output-Referred Noise                  |                   | From CLPF                                               |      | 8     |      | nV/ $\sqrt{\text{Hz}}$ |
| Small-Signal Bandwidth                 | BW                | From CLPF                                               |      | 20    |      | MHz                    |
| Slew Rate                              |                   | V <sub>OUT</sub> = 0.2V to 2.6V                         |      | 8     |      | V/ $\mu$ s             |

# 2.5GHz 45dB RF-Detecting Controllers

MAX4000/MAX4001/MAX4002

## ELECTRICAL CHARACTERISTICS

( $V_{CC} = 3V$ ,  $\overline{SHDN} = 1.8V$ ,  $f_{RF} = 100MHz$  to  $2.5GHz$ ,  $T_A = -40^{\circ}C$  to  $+85^{\circ}C$ , unless otherwise noted. Typical values are at  $T_A = +25^{\circ}C$ .) (Note 1)

| PARAMETER                                                   | SYMBOL   | CONDITIONS                                         |         | MIN  | TYP  | MAX  | UNITS      |
|-------------------------------------------------------------|----------|----------------------------------------------------|---------|------|------|------|------------|
| RF Input Frequency                                          | $f_{RF}$ |                                                    |         | 100  |      | 2500 | MHz        |
| RF Input Voltage Range<br>(Note 4)                          | $V_{RF}$ | MAX4000                                            |         | -58  |      | -13  | dBV        |
|                                                             |          | MAX4001                                            |         | -48  |      | -3   |            |
|                                                             |          | MAX4002                                            |         | -43  |      | +2   |            |
| Equivalent Power Range<br>(50 $\Omega$ Terminated) (Note 4) | $P_{RF}$ | MAX4000                                            |         | -45  |      | 0    | dBm        |
|                                                             |          | MAX4001                                            |         | -35  |      | +10  |            |
|                                                             |          | MAX4002                                            |         | -30  |      | +15  |            |
| Logarithmic Slope                                           | $V_S$    | $f_{RF} = 100MHz$                                  |         | 22.5 | 25.5 | 28.5 | mV/dB      |
|                                                             |          | $f_{RF} = 900MHz$                                  |         |      | 25   |      |            |
|                                                             |          | $f_{RF} = 1900MHz$                                 |         |      | 29   |      |            |
| Logarithmic Intercept                                       | $P_X$    | $f_{RF} = 100MHz$                                  | MAX4000 | -62  | -55  | -49  | dBm        |
|                                                             |          |                                                    | MAX4001 | -52  | -45  | -39  |            |
|                                                             |          |                                                    | MAX4002 | -47  | -40  | -34  |            |
|                                                             |          | $f_{RF} = 900MHz$                                  | MAX4000 |      | -57  |      |            |
|                                                             |          |                                                    | MAX4001 |      | -48  |      |            |
|                                                             |          |                                                    | MAX4002 |      | -43  |      |            |
|                                                             |          | $f_{RF} = 1900MHz$                                 | MAX4000 |      | -56  |      |            |
|                                                             |          |                                                    | MAX4001 |      | -45  |      |            |
|                                                             |          |                                                    | MAX4002 |      | -41  |      |            |
| <b>RF INPUT INTERFACE</b>                                   |          |                                                    |         |      |      |      |            |
| DC Resistance                                               | $R_{DC}$ | MAX4001/MAX4002, connected to $V_{CC}$<br>(Note 5) |         |      | 2    |      | k $\Omega$ |
| Inband Resistance                                           | $R_{IB}$ |                                                    |         |      | 2    |      | k $\Omega$ |
| Inband Capacitance                                          | $C_{IB}$ | MAX4000, internally AC-coupled<br>(Note 6)         |         |      | 0.5  |      | pF         |

**Note 1:** All devices are 100% production tested at  $T_A = +25^{\circ}C$  and are guaranteed by design for  $T_A = -40^{\circ}C$  to  $+85^{\circ}C$  as specified. All production AC testing is done at 100MHz.

**Note 2:** Typical value only, set-point input voltage range determined by logarithmic slope and logarithmic intercept.

**Note 3:** Set-point slew rate is the rate at which the reference level voltage, applied to the inverting input of the  $g_m$  stage, responds to a voltage step at the SET pin (see Figure 1).

**Note 4:** Typical min/max range for detector.

**Note 5:** MAX4000 internally AC-coupled.

**Note 6:** MAX4001/MAX4002 are internally resistive-coupled to  $V_{CC}$ .

# 2.5GHz 45dB RF-Detecting Controllers

## Typical Operating Characteristics

( $V_{CC} = 3V$ ,  $\overline{SHDN} = V_{CC}$ ,  $T_A = +25^\circ C$ , unless otherwise specified.)

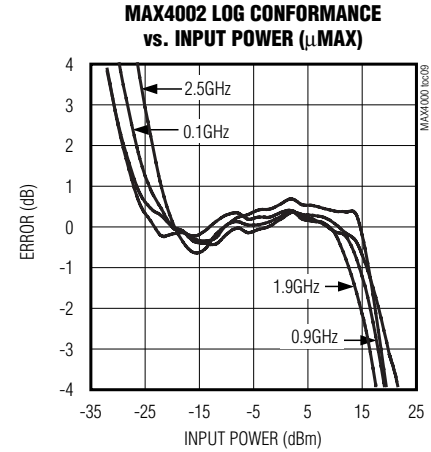
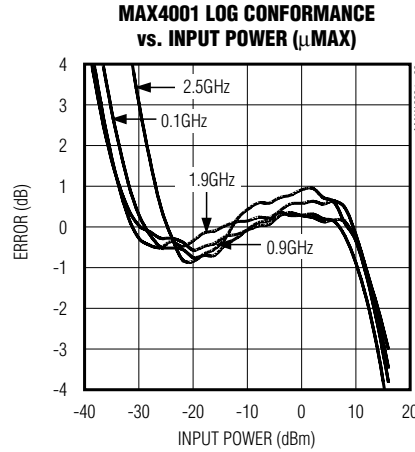
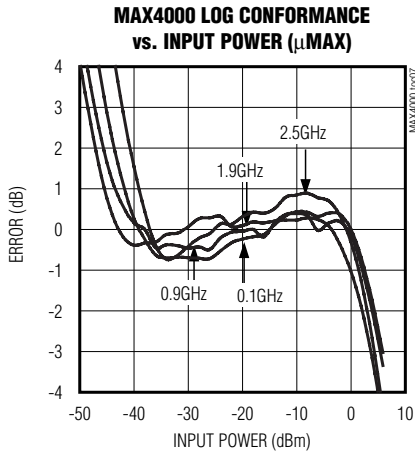
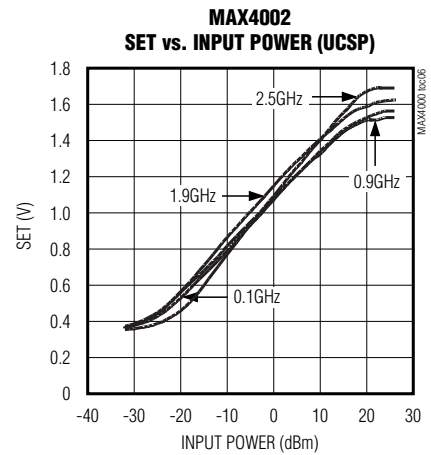
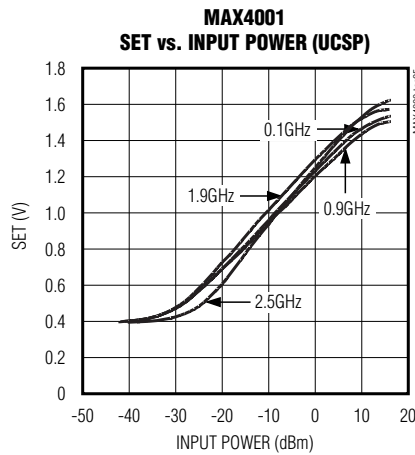
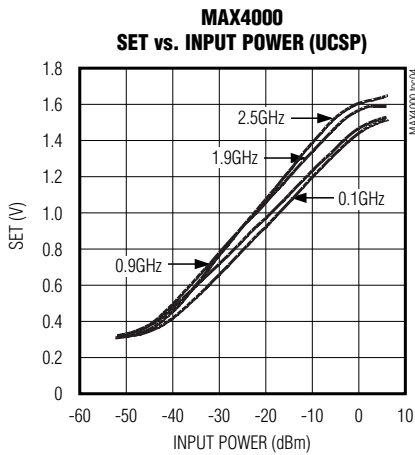
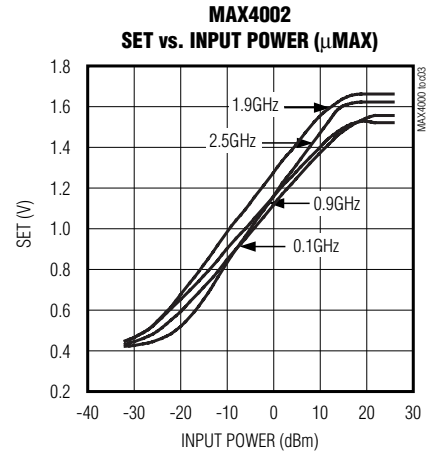
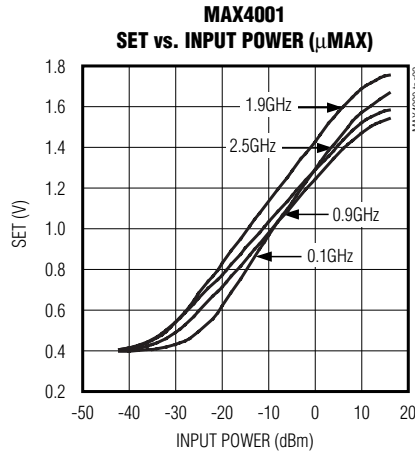
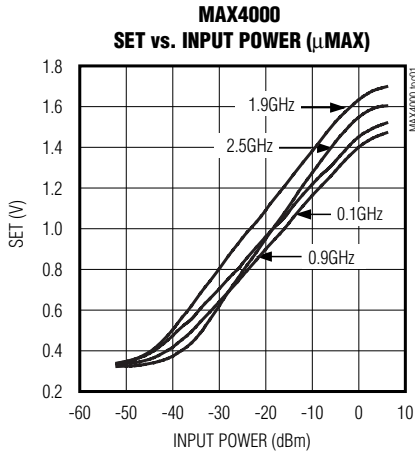

# 2.5GHz 45dB RF-Detecting Controllers

## Typical Operating Characteristics (continued)

( $V_{CC} = 3V$ ,  $SHDN = V_{CC}$ ,  $T_A = +25^\circ C$ , unless otherwise specified.)

MAX4000/MAX4001/MAX4002

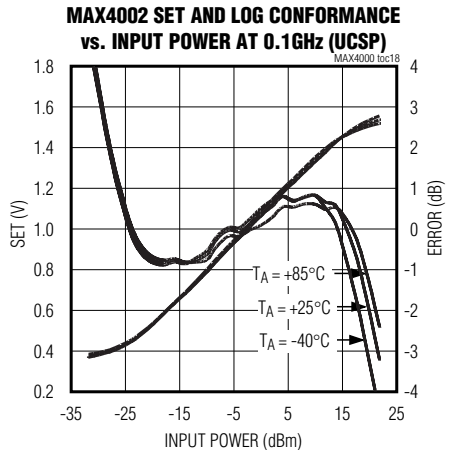
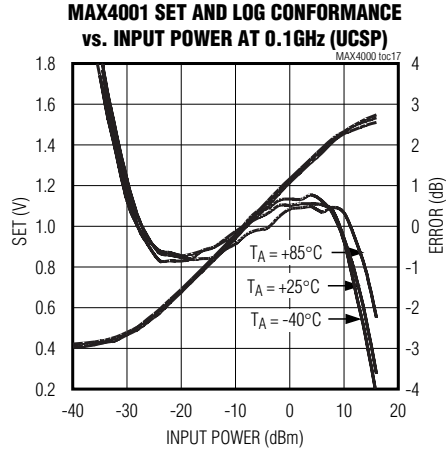
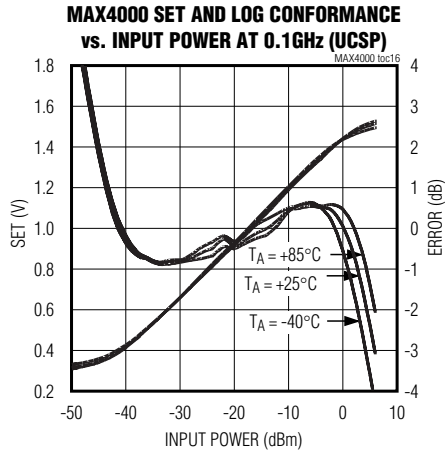
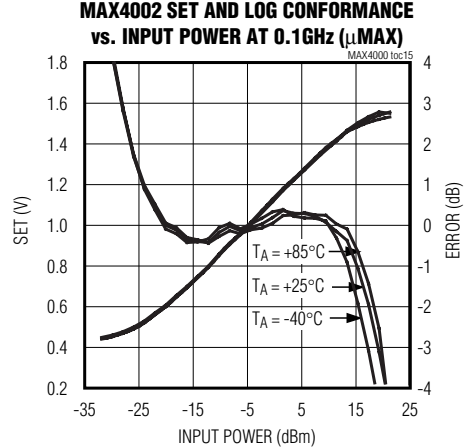
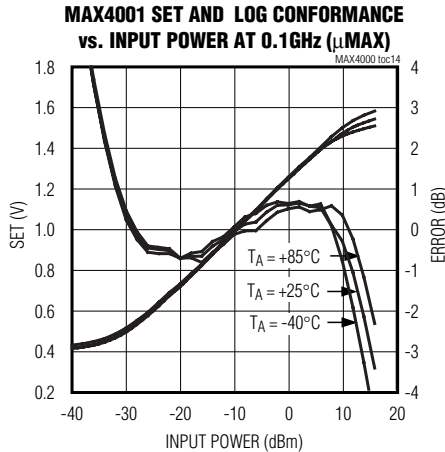
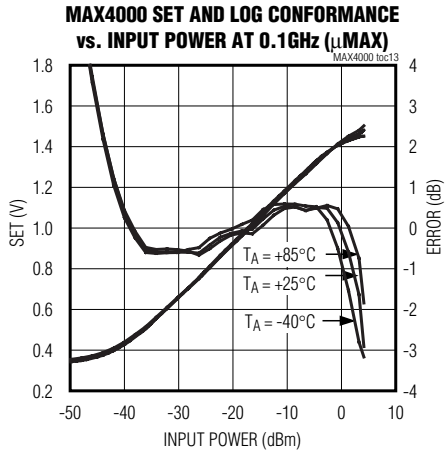
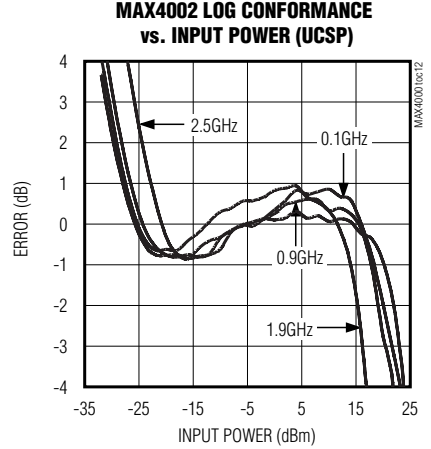
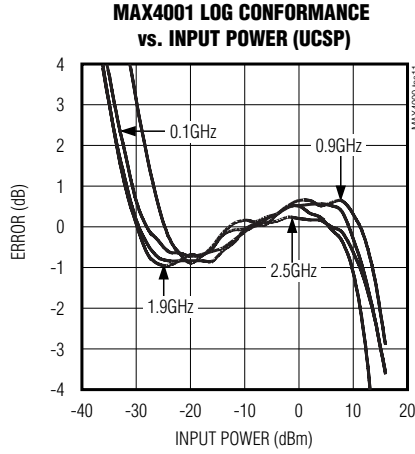
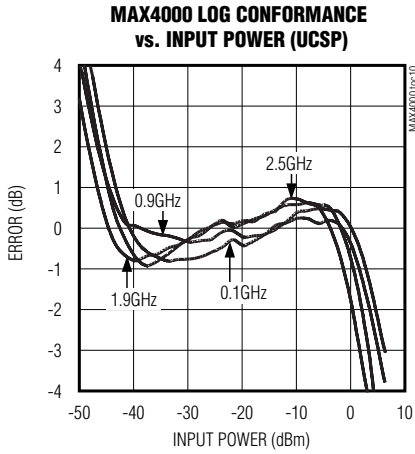

# 2.5GHz 45dB RF-Detecting Controllers

## Typical Operating Characteristics (continued)

( $V_{CC} = 3V$ ,  $SHDN = V_{CC}$ ,  $T_A = +25^\circ C$ , unless otherwise specified.)

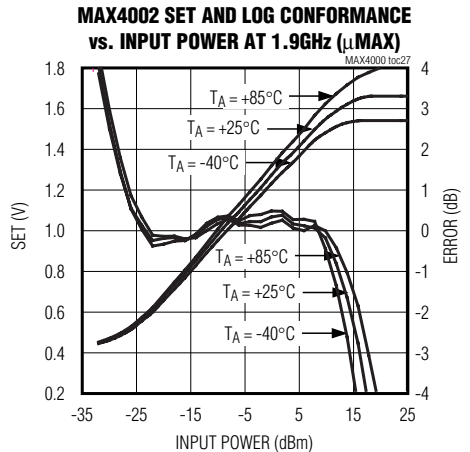
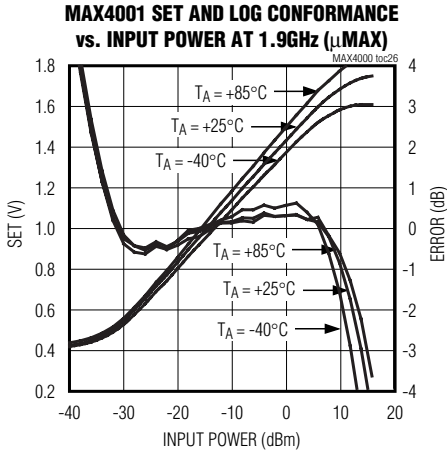
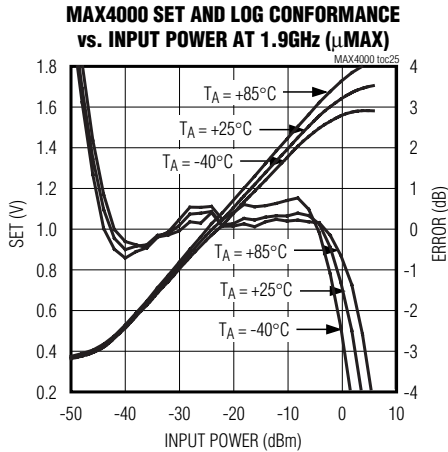
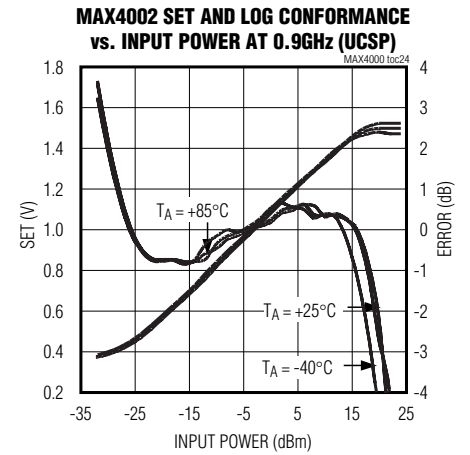
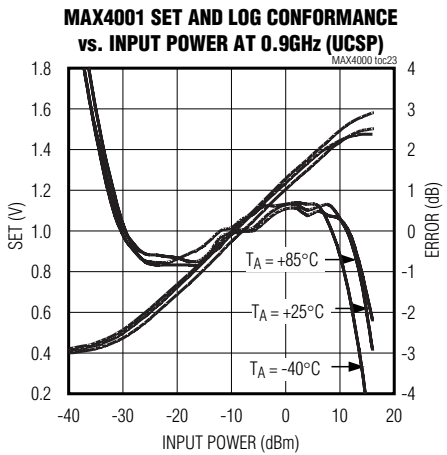
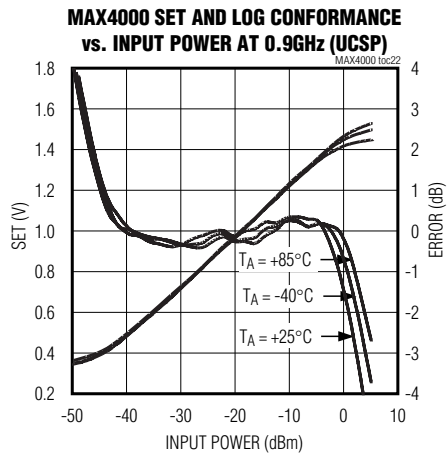
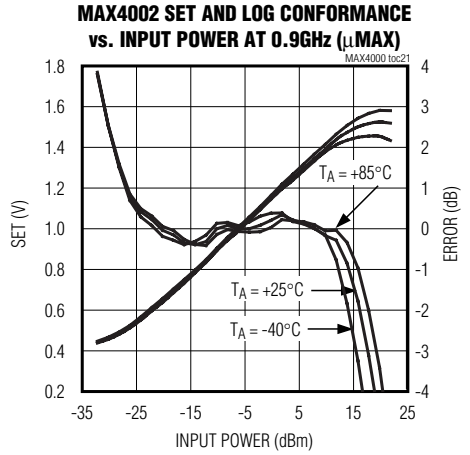
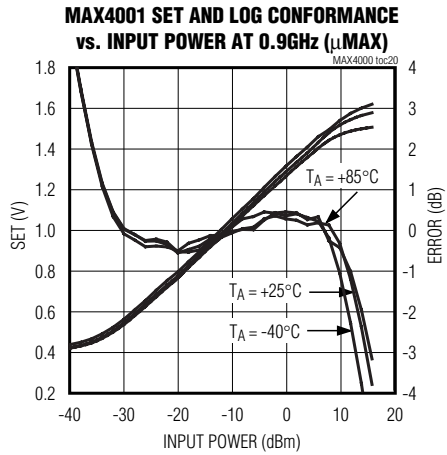
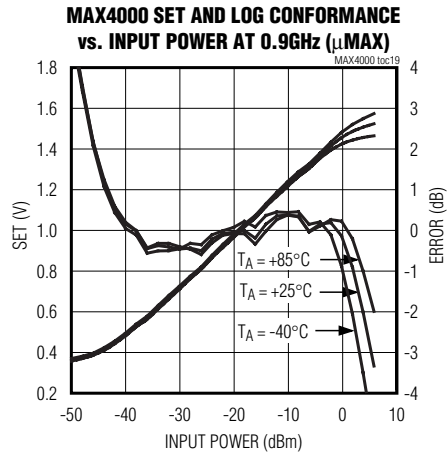

# 2.5GHz 45dB RF-Detecting Controllers

## Typical Operating Characteristics (continued)

( $V_{CC} = 3V$ ,  $\overline{SHDN} = V_{CC}$ ,  $T_A = +25^\circ C$ , unless otherwise specified.)

MAX4000/MAX4001/MAX4002

**MAX4000 SET AND LOG CONFORMANCE vs. INPUT POWER AT 1.9GHz (UCSP)**

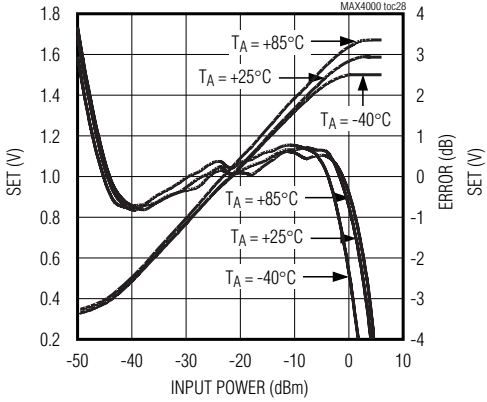

**MAX4001 SET AND LOG CONFORMANCE vs. INPUT POWER AT 1.9GHz (UCSP)**

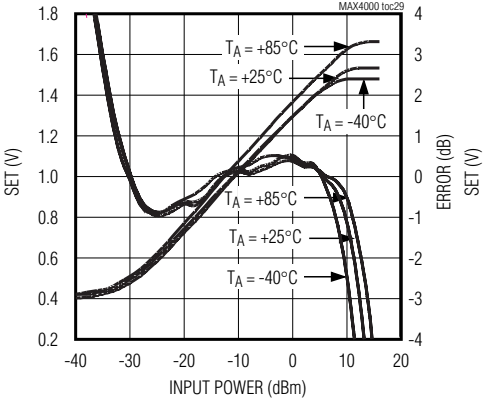

**MAX4002 SET AND LOG CONFORMANCE vs. INPUT POWER AT 1.9GHz (UCSP)**

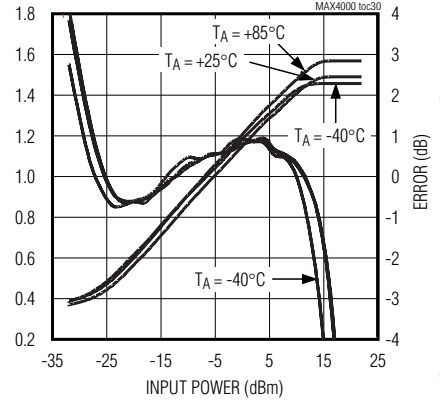

**MAX4000 SET AND LOG CONFORMANCE vs. INPUT POWER AT 2.5GHz ( $\mu$ MAX)**

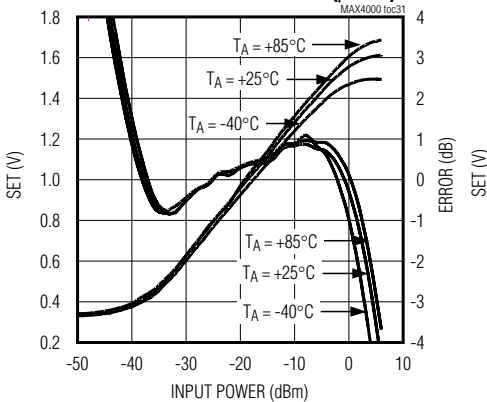

**MAX4001 SET AND LOG CONFORMANCE vs. INPUT POWER AT 2.5GHz ( $\mu$ MAX)**

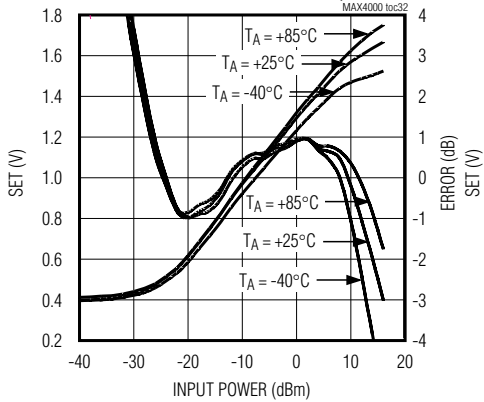

**MAX4002 SET AND LOG CONFORMANCE vs. INPUT POWER AT 2.5GHz ( $\mu$ MAX)**

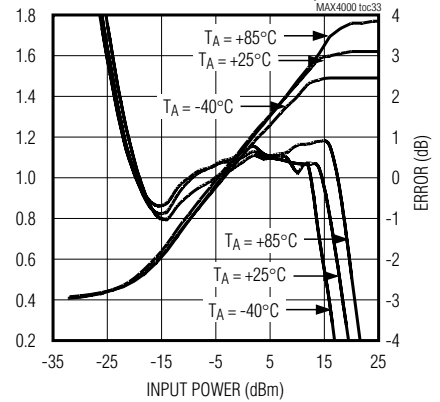

**MAX4000 SET AND LOG CONFORMANCE vs. INPUT POWER AT 2.5GHz (UCSP)**

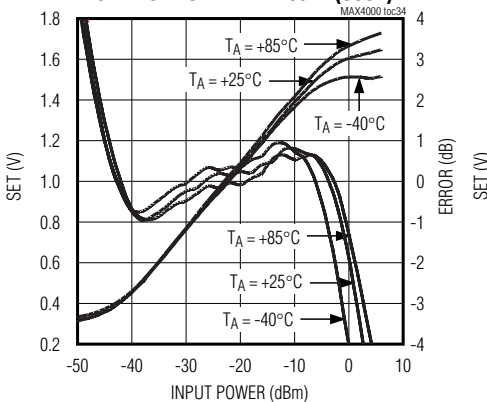

**MAX4001 SET AND LOG CONFORMANCE vs. INPUT POWER AT 2.5GHz (UCSP)**

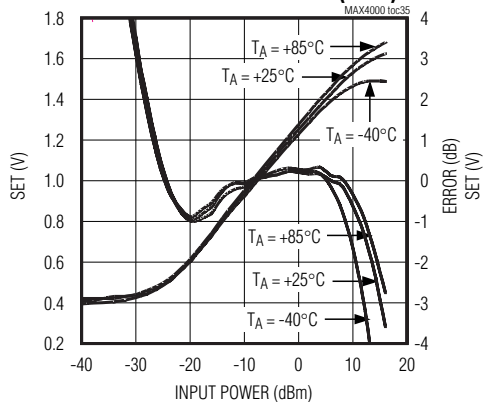

**MAX4002 SET AND LOG CONFORMANCE vs. INPUT POWER AT 2.5GHz (UCSP)**

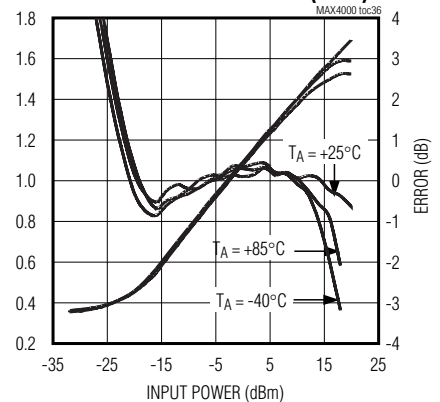

# 2.5GHz 45dB RF-Detecting Controllers

## Typical Operating Characteristics (continued)

( $V_{CC} = 3V$ ,  $\overline{SHDN} = V_{CC}$ ,  $T_A = +25^\circ C$ , unless otherwise specified.)

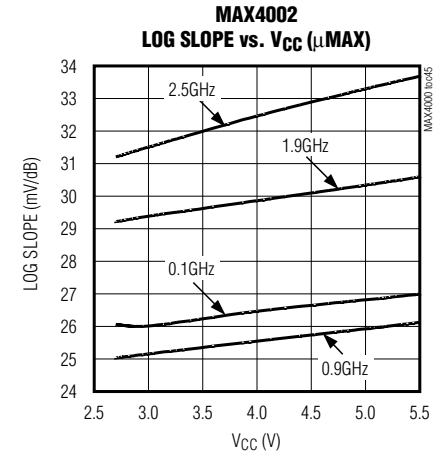
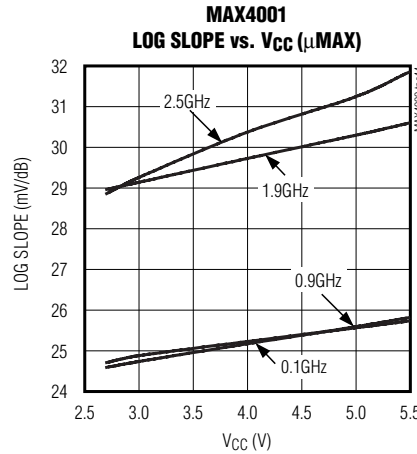
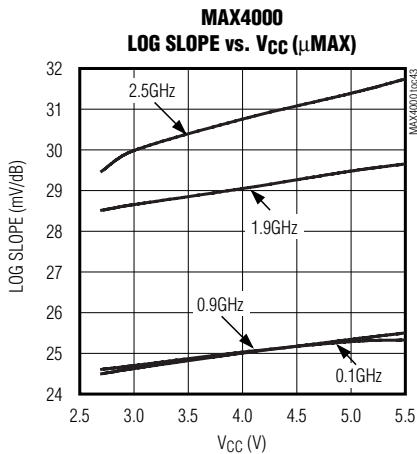
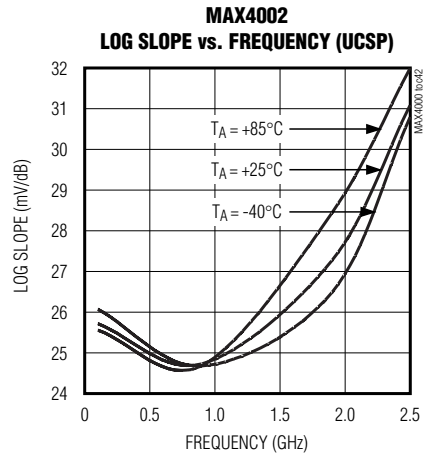
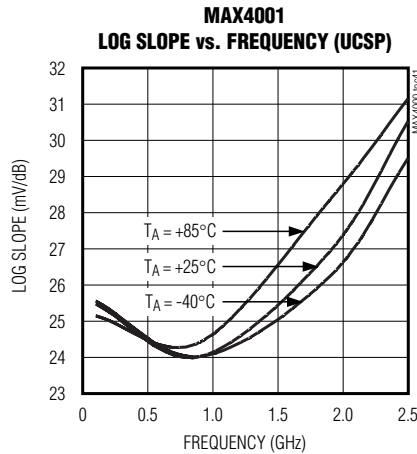
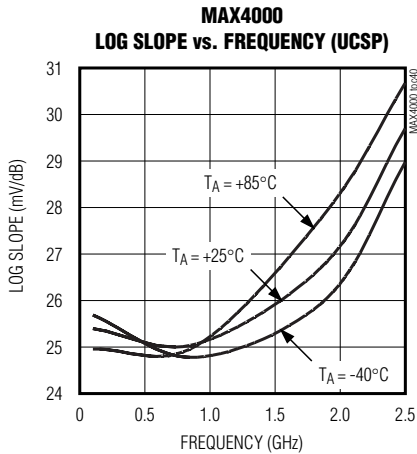
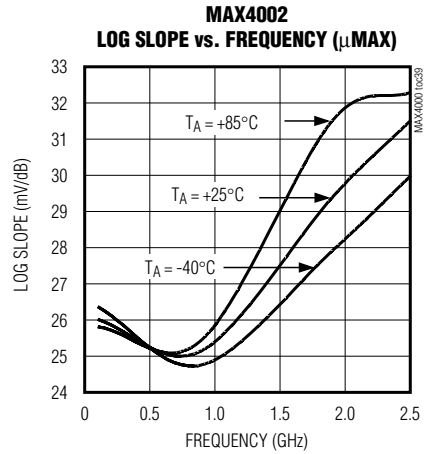
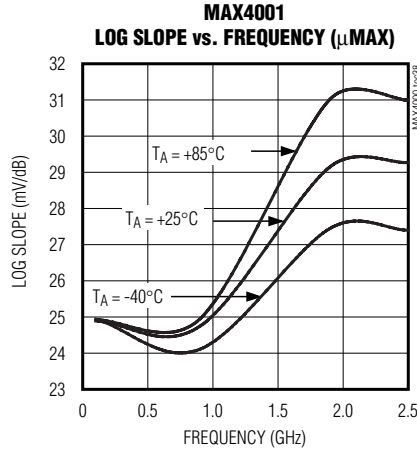
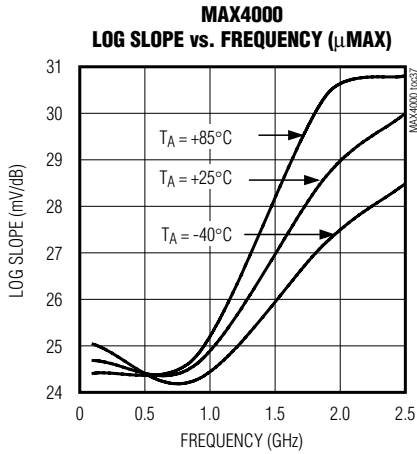



# 2.5GHz 45dB RF-Detecting Controllers

## Typical Operating Characteristics (continued)

( $V_{CC} = 3V$ ,  $\overline{SHDN} = V_{CC}$ ,  $T_A = +25^\circ C$ , unless otherwise specified.)

MAX4000/MAX4001/MAX4002

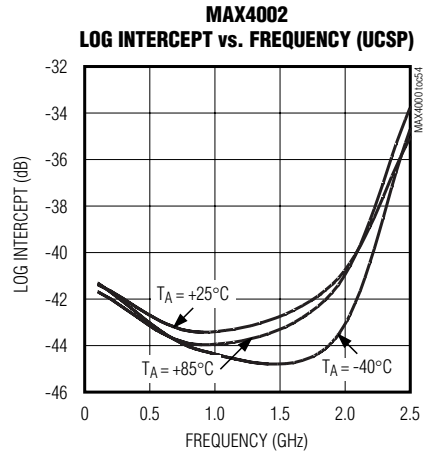
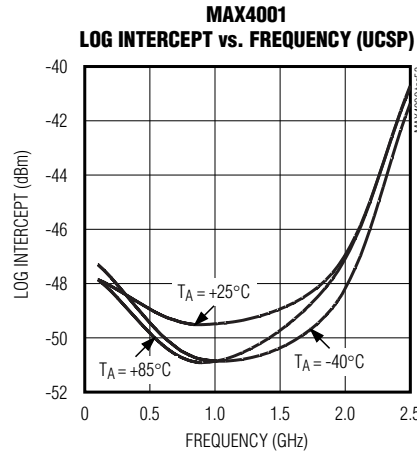
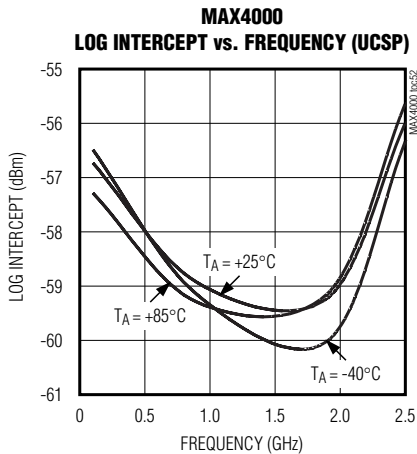
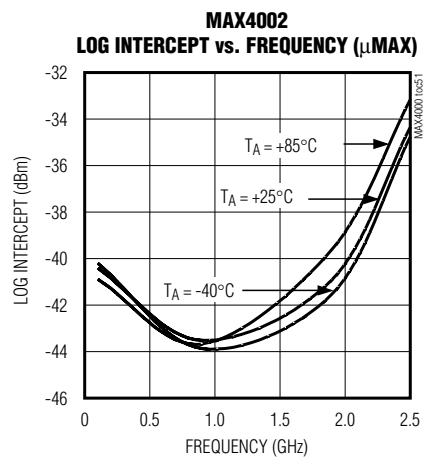
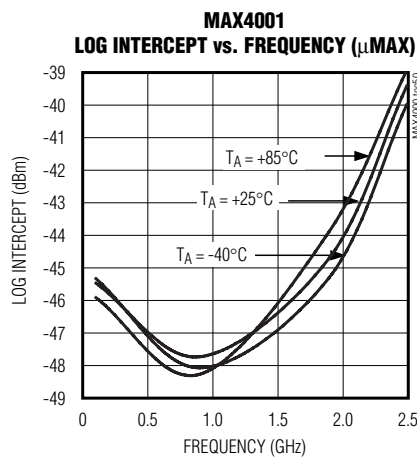
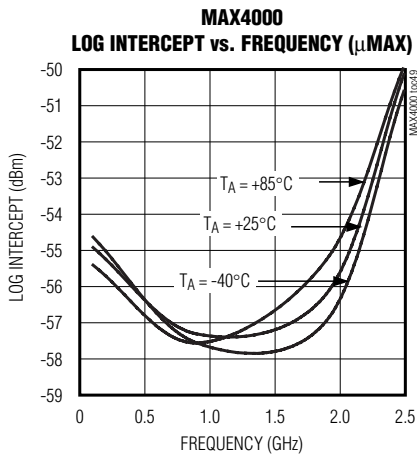
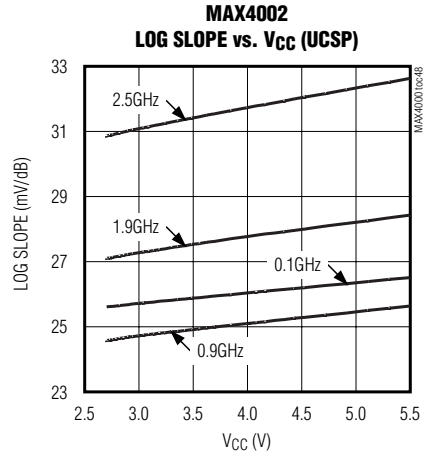
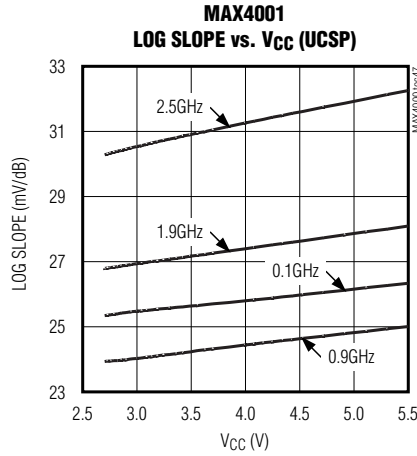
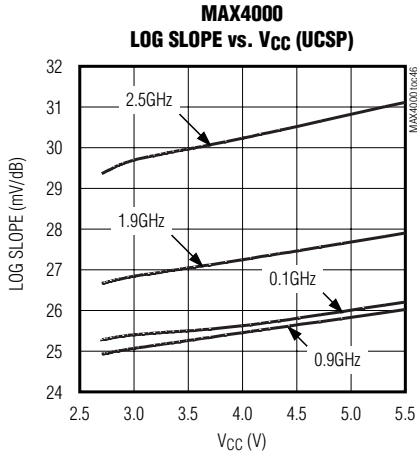

# 2.5GHz 45dB RF-Detecting Controllers

## Typical Operating Characteristics (continued)

( $V_{CC} = 3V$ ,  $\overline{SHDN} = V_{CC}$ ,  $T_A = +25^\circ C$ , unless otherwise specified.)

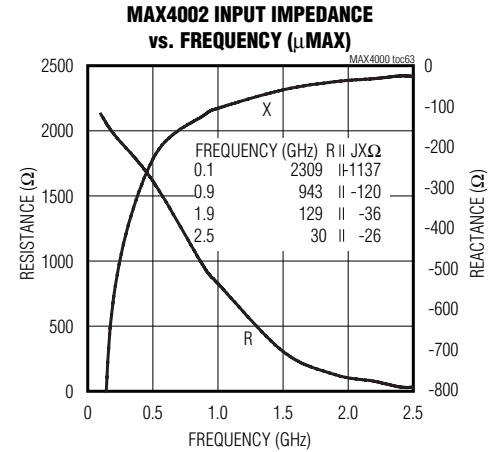
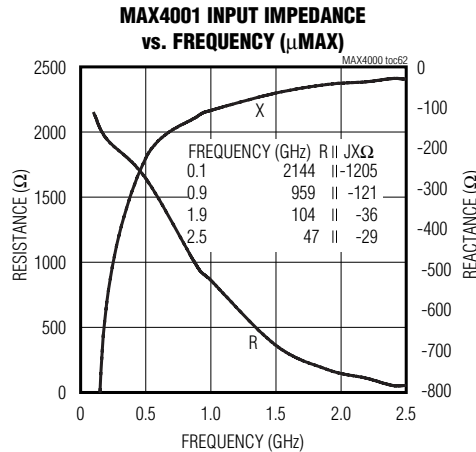
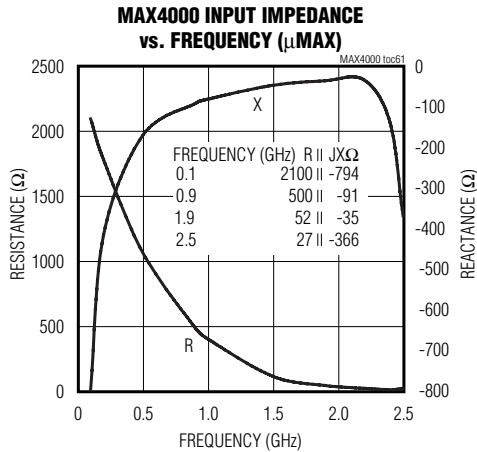
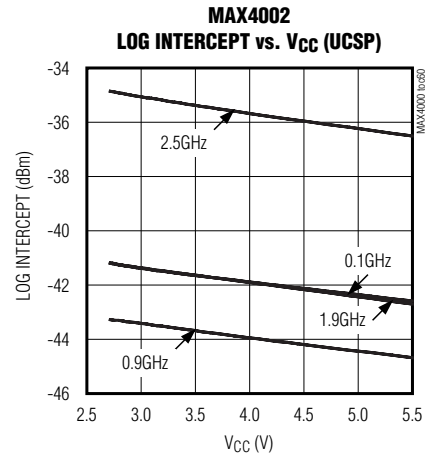
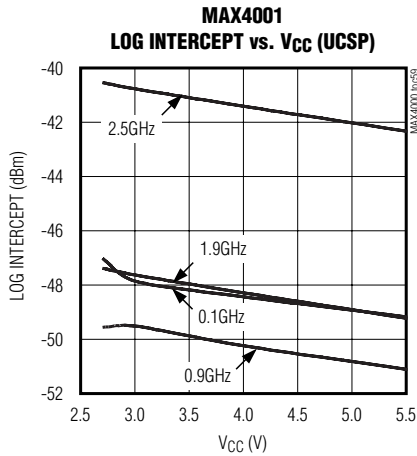
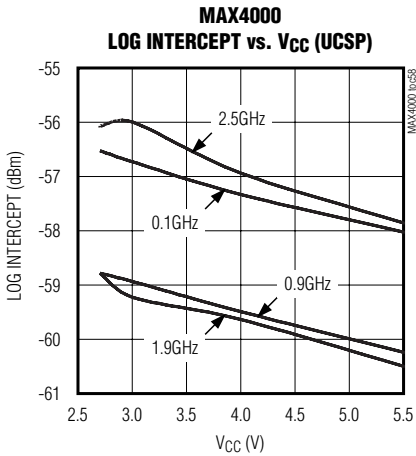
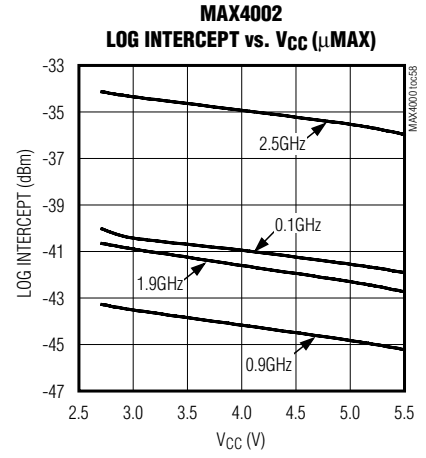
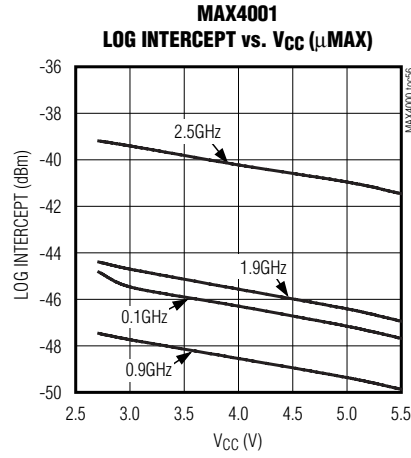
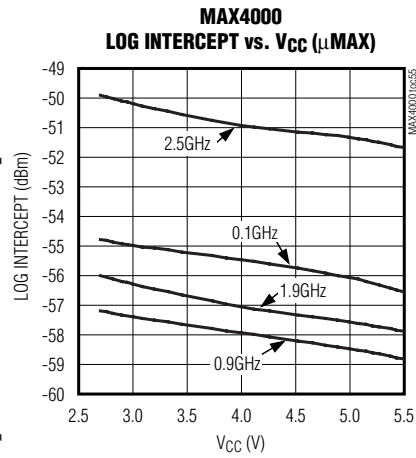

# 2.5GHz 45dB RF-Detecting Controllers

## Typical Operating Characteristics (continued)

( $V_{CC} = 3V$ ,  $\overline{SHDN} = V_{CC}$ ,  $T_A = +25^\circ C$ , unless otherwise specified.)

MAX4000/MAX4001/MAX4002

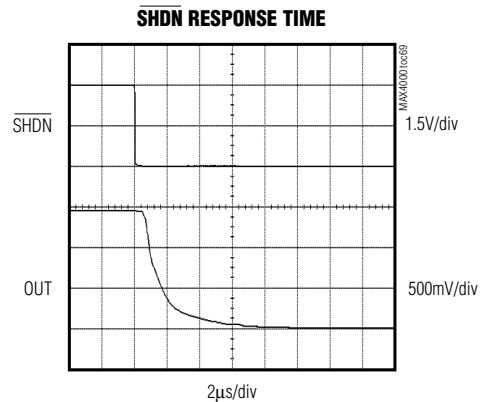
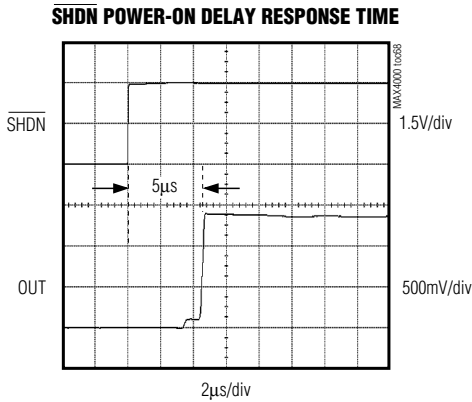
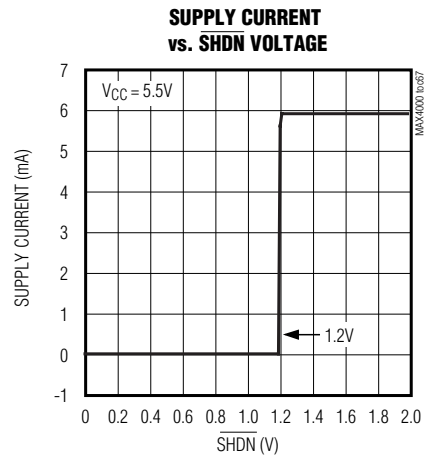
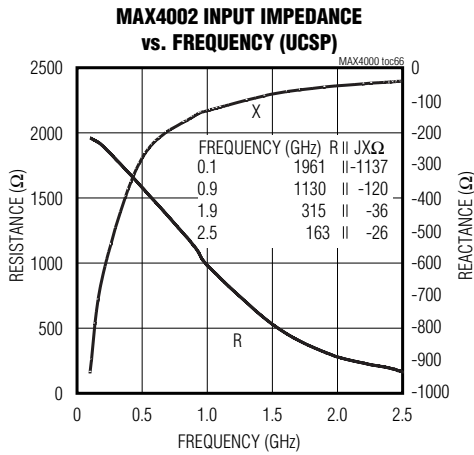
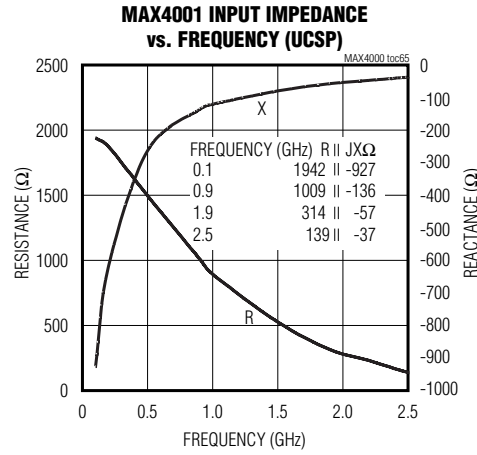
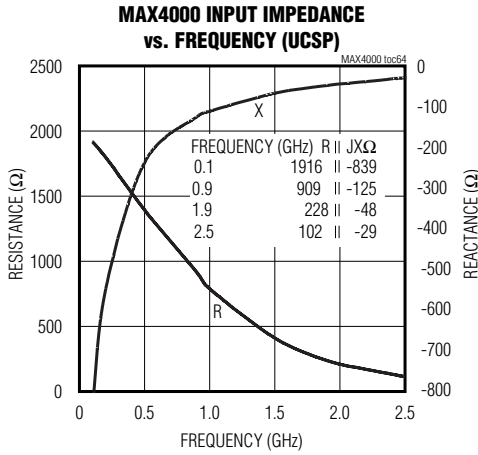

# 2.5GHz 45dB RF-Detecting Controllers

## Typical Operating Characteristics (continued)

( $V_{CC} = 3V$ ,  $\overline{SHDN} = V_{CC}$ ,  $T_A = +25^\circ C$ , unless otherwise specified.)

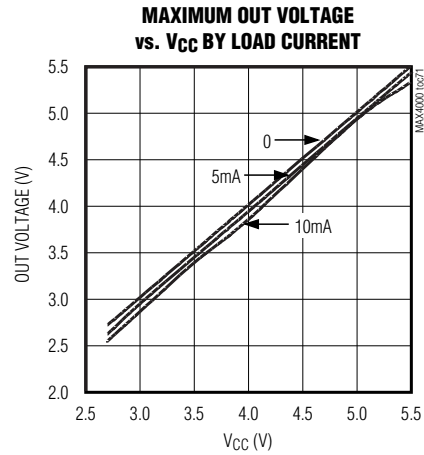
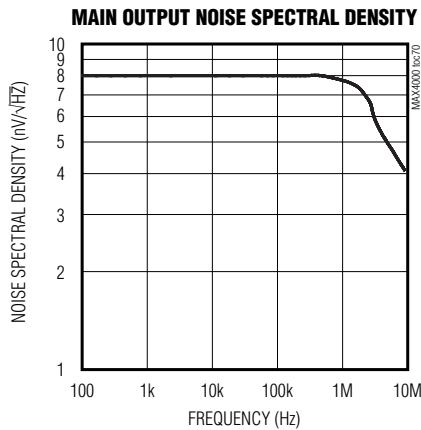

## Pin Description

| PIN       |        | NAME              | FUNCTION                                                                                                  |
|-----------|--------|-------------------|-----------------------------------------------------------------------------------------------------------|
| $\mu$ MAX | UCSP   |                   |                                                                                                           |
| 1         | A1     | RFIN              | RF Input                                                                                                  |
| 2         | A2     | $\overline{SHDN}$ | Shutdown. Connect to $V_{CC}$ for normal operation.                                                       |
| 3         | A3     | SET               | Set-Point Input for Controller Mode Operation                                                             |
| 4         | B3     | CLPF              | Lowpass Filter Connection. Connect external capacitor between CLPF and GND to set control-loop bandwidth. |
| 5         | C3     | GND               | Ground                                                                                                    |
| 6         | —      | N.C.              | No Connection. Not internally connected.                                                                  |
| 7         | C2     | OUT               | Output to PA Gain-Control Pin                                                                             |
| 8         | B1, C1 | VCC               | Supply Voltage. $V_{CC} = 2.7V$ to $5.5V$ .                                                               |

# 2.5GHz 45dB RF-Detecting Controllers

MAX4000/MAX4001/MAX4002

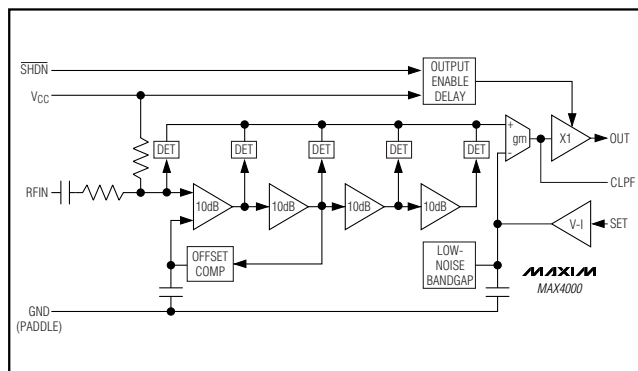

Figure 1. Functional Diagram

## Detailed Description

The MAX4000/MAX4001/MAX4002 family of logarithmic amplifiers (log amps) is comprised of four main amplifier/limiter stages each with a small-signal gain of 10dB. The output stage of each amplifier is applied to a full-wave rectifier (detector). A detector stage also precedes the first gain stage. In total, five detectors each separated by 10dB, comprise the log amp strip. Figure 1 shows the functional diagram of the log amps.

A portion of the PA output power is coupled to RFIN of the log amp controller, and is applied to the log amp strip. Each detector cell outputs a rectified current and all cell currents are summed and form a logarithmic output. The detected output is applied to a high-gain gm stage, which is buffered and then applied to OUT. OUT is applied to the gain-control pin of the PA to close the control loop. The voltage applied to SET determines the output power of the PA in the control loop. The voltage applied to SET relates to an input power level determined by the log amp detector characteristics.

Extrapolating a straight-line fit of the graph of SET vs. RFIN provides the logarithmic intercept. Logarithmic slope, the amount SET changes for each dB change of RF input, is generally independent of waveform or termination impedance. The MAX4000/MAX4001/MAX4002 slope at low frequencies is about 25mV/dB. Variance in temperature and supply voltage does not alter the slope significantly as shown in the *Typical Operating Characteristics*.

The MAX4000/MAX4001/MAX4002 are specifically designed for use in PA control applications. In a control loop, the output starts at approximately 2.9V (with supply voltage of 3V) for the minimum input signal and falls to a value close to ground at the maximum input. With a portion of the PA output power coupled to RFIN, apply a voltage to SET and connect OUT to the gain-control pin of the PA to control its output power. An external

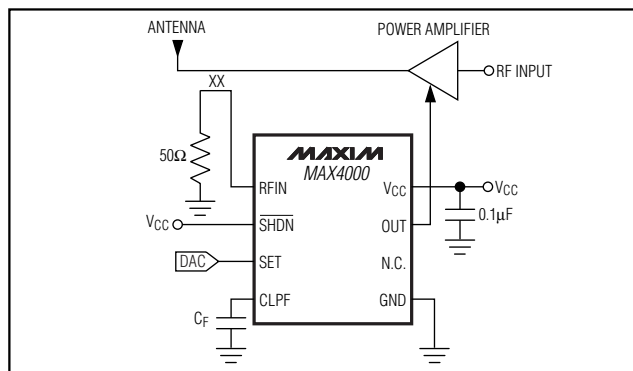

Figure 2. Controller Mode Application Circuit Block

capacitor from the CLPF pin to ground sets the bandwidth of the PA control loop.

## Transfer Function

Logarithmic slope and intercept determine the transfer function of the MAX4000/MAX4001/MAX4002 family of log amps. The change in SET voltage per dB change in RF input defines the logarithmic slope. Therefore, a 10dB change in RF input results in a 250mV change at SET. The Log-Conformance plots (see *Typical Operating Characteristics*) show the dynamic range of the log amp family. Dynamic range is the range for which the error remains within a band of  $\pm 1$ dB.

The intercept is defined as the point where the linear response, when extrapolated, intersects the y-axis of the Log-Conformance plot. Using these parameters, the input power can be calculated at any SET voltage level within the specified input range with the following equation:

$$RFIN = \frac{SET}{SLOPE} + IP$$

where SET is the set-point voltage, SLOPE is the logarithmic slope (V/dB), RFIN is in either dBm or dBV and IP is the logarithmic intercept point utilizing the same units as RFIN.

## Applications Information

### Controller Mode

Figure 2 provides a circuit example of the MAX4000/MAX4001/MAX4002 configured as a controller. The MAX4000/MAX4001/MAX4002 require a 2.7V to 5.5V supply voltage. Place a 0.1μF low-ESR, surface-mount ceramic capacitor close to VCC to decouple the supply. Electrically isolate the RF input from other pins (especially SET) to maximize performance at high frequencies (especially at the high-power levels of the MAX4002). The MAX4000 has an internal input-coupling capacitor

## 2.5GHz 45dB RF-Detecting Controllers

and does not require external AC-coupling. Achieve  $50\Omega$  input matching by connecting a  $50\Omega$  resistor between RFIN and ground. See the *Typical Operating Characteristics* section for a plot of Input Impedance vs. Frequency. See the *Additional Input Coupling* section for other coupling methods.

The MAX4000/MAX4001/MAX4002 log amps function as both the detector and controller in power-control loops. Use a directional coupler to couple a portion of the PA's output power to the log amp's RF input. In applications requiring dual-mode operation where there are two PAs and two directional couplers, passively combine the outputs of the directional couplers before applying to the log amp. Apply a set-point voltage to SET from a controlling source (usually a DAC). OUT, which drives the automatic gain-control pin of the PA, corrects any inequality between the RF input level and the corresponding set-point level. This is valid assuming the gain control of the variable gain element is positive, such that increasing OUT voltage increases gain. OUT voltage can range from 150mV to within 250mV of the supply rail while sourcing 10mA. Use a suitable load resistor between OUT and GND for PA control inputs that source current. The *Typical Operating Characteristics* section has a plot of the sourcing capabilities and output swing of OUT.

### SHDN and Power-On

The MAX4000/MAX4001/MAX4002 can be placed in shutdown by pulling SHDN to ground. SHDN reduces supply current to typically  $13\mu\text{A}$ . A graph of SHDN Response is included in the *Typical Operating Characteristics* section. Connect SHDN and VCC together for continuous on-operation.

### Power Convention

Expressing power in dBm, decibels above 1mW, is the most common convention in RF systems. Log amp input levels specified in terms of power are a result of following common convention. Note that input power does not refer to power, but rather to input voltage relative to a  $50\Omega$  impedance. Use of dBV, decibels with respect to a  $1\text{V}_{\text{RMS}}$  sine wave, yields a less ambiguous result. The dBV convention has its own pitfalls in that log amp response is also dependent on waveform. A complex input such as CDMA does not have the exact same output response as the sinusoidal signal. The MAX4000/MAX4001/MAX4002 performance specifications are in both dBV and dBm, with equivalent dBm levels for a  $50\Omega$  environment. To convert dBV values into dBm in a  $50\Omega$  network, add 13dB.

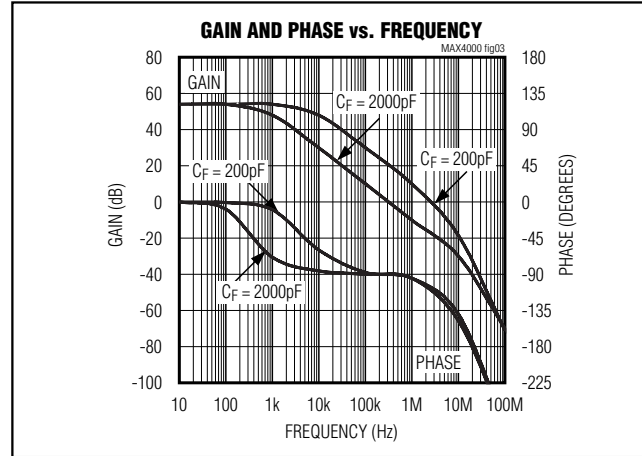

Figure 3. Gain and Phase vs. Frequency Graph

### Filter Capacitor and Transient Response

In general, the choice of filter capacitor only partially determines the time-domain response of a PA control loop. However, some simple conventions can be applied to affect transient response. A large filter capacitor,  $C_F$ , dominates time-domain response, but the loop bandwidth remains a factor of the PA gain-control range. The bandwidth is maximized at power outputs near the center of the PA's range, and minimized at the low and high power levels, where the slope of the gain-control curve is lowest.

A smaller valued  $C_F$  results in an increased loop bandwidth inversely proportional to the capacitor value. Inherent phase lag in the PA's control path, usually caused by parasitics at the OUT pin, ultimately results in the addition of complex poles in the AC loop equation. To avoid this secondary effect, experimentally determine the lowest usable  $C_F$  for the power amplifier of interest. This requires full consideration to the intricacies of the PA control function. The worst-case condition, where the PA output is smallest (gain function is steepest), should be used because the PA control function is typically nonlinear. An additional zero can be added to improve loop dynamics by placing a resistor in series with  $C_F$ . See Figure 3 for the gain and phase response for different  $C_F$  values.

### Additional Input Coupling

There are three common methods for input coupling: broadband resistive, narrowband reactive, and series attenuation. A broadband resistive match is implemented by connecting a resistor to ground at RFIN as shown in Figure 4a. A  $50\Omega$  resistor (use other values for different input impedances) in this configuration in parallel with the input impedance of the MAX4000 presents an input

# 2.5GHz 45dB RF-Detecting Controllers

impedance of approximately 50Ω. See the *Typical Operating Characteristics* for the input impedance plot to determine the required external termination at the frequency of interest. The MAX4001/MAX4002 require an additional external coupling capacitor in series with the RF input. As the operating frequency increases over 2GHz, input impedance is reduced, resulting in the need for a larger-valued shunt resistor. Use a Smith Chart for calculating the ideal shunt resistor value.

For high frequencies, use narrowband reactive coupling. This implementation is shown in Figure 4b. The matching components are drawn as reactances since these can be either capacitors or inductors depending on the input impedance at the desired frequency and available standard value components. A Smith Chart is used to obtain the input impedance at the desired frequency and then matching reactive components are chosen. Table 1 provides standard component values at some common frequencies for the MAX4001. Note that these inductors must have a high SRF (self-resonant frequency), much higher than the intended frequency of operation to implement this matching scheme.

Device sensitivity is increased by the use of a reactive matching network, because a voltage gain occurs before being applied to RFIN. The associated gain is calculated with the following equation:

$$\text{Voltage Gain}_{\text{dB}} = 20 \log_{10} \sqrt{\frac{R_2}{R_1}}$$

where R1 is the source impedance to which the device is being matched, and R2 is the input resistance of the device. The gain is the best-case scenario for a perfect match. However, component tolerance and standard value choice often result in a reduced gain.

Figure 4c demonstrates series attenuation coupling. This method is intended for use in applications where the RF input signal is greater than the input range of the device. The input signal is thus resistively divided by the use of a series resistor connected to the RF source. Since the MAX4000/MAX4001/MAX4002 log amps offer a wide selection of RF input ranges, series attenuation coupling is not needed for typical applications.

**Table 1. Suggested Components for MAX4001 Reactive Matching Network**

| FREQUENCY (GHz) | jx1 (nH) | jx2 (nH) | VOLTAGE GAIN (dB) |
|-----------------|----------|----------|-------------------|
| 0.9             | 38       | 47       | 12.8              |
| 1.9             | 4.4      | 4.7      | 3.2               |
| 2.5             | —        | 1.8      | -0.3              |

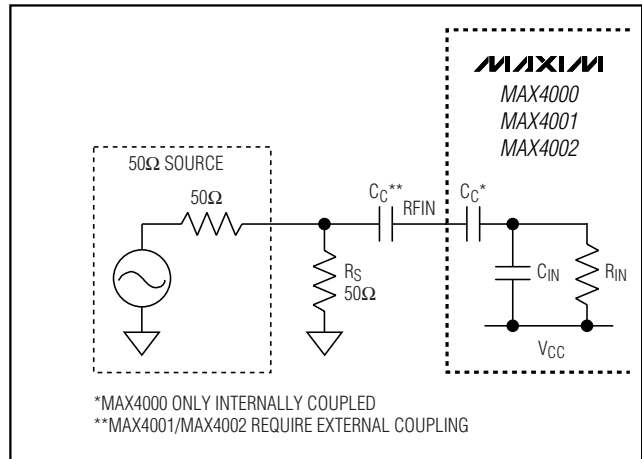

Figure 4a. Broadband Resistive Matching

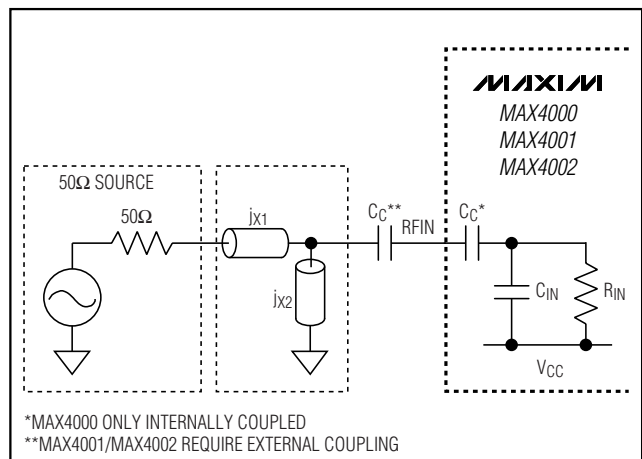

Figure 4b. Narrowband Reactive Matching

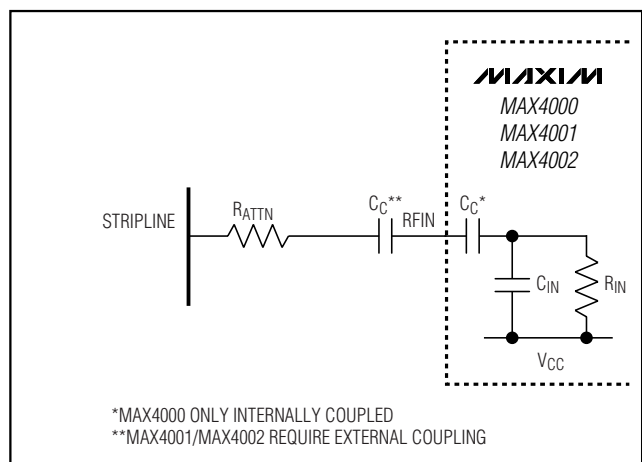

Figure 4c. Series Attenuation Network

## 2.5GHz 45dB RF-Detecting Controllers

### Waveform Considerations

The MAX4000/MAX4001/MAX4002 family of log amps respond to voltage, not power, even though input levels are specified in dBm. It is important to realize that input signals with identical RMS power but unique waveforms results in different log amp outputs.

Differing signal waveforms result in either an upward or downward shift in the logarithmic intercept. However, the logarithmic slope remains the same.

### Layout Considerations

As with any RF circuit, the layout of the MAX4000/MAX4001/MAX4002 circuits affects performance. Use a short 50Ω line at the input with multiple ground vias along the length of the line. The input capacitor and resistor should both be placed as close to the IC as possible. V<sub>CC</sub> should be bypassed as close as possible to the IC with multiple vias connecting the capacitor to the ground plane. It is recommended that good RF components be chosen for the desired operating frequency range. **Electrically isolate RF input from other pins (especially SET) to maximize performance at high frequencies (especially at the high power levels of the MAX4002).**

### UCSP Reliability

The UCSP represents a unique package that greatly reduces board space compared to other packages. UCSP reliability is integrally linked to the user's assembly methods, circuit board material, and usage environment. The user should closely review these areas when considering use of a UCSP. This form factor may not perform equally to a packaged product through traditional mechanical reliability tests. Performance through operating life test and moisture resistance remains uncompromised as it is primarily determined by the wafer fabrication process. Mechanical stress performance is a greater consideration for a UCSP. UCSP solder joint contact integrity must be considered since the package is attached through direct solder contact to the user's PC board. Testing done to characterize the UCSP reliability performance shows that it is capable of performing reliably through environmental stresses. Results of environmental stress tests and additional usage data and recommendations are detailed in the UCSP application note, which can be found on Maxim's website, [www.maxim-ic.com](http://www.maxim-ic.com).

### Pin Configurations

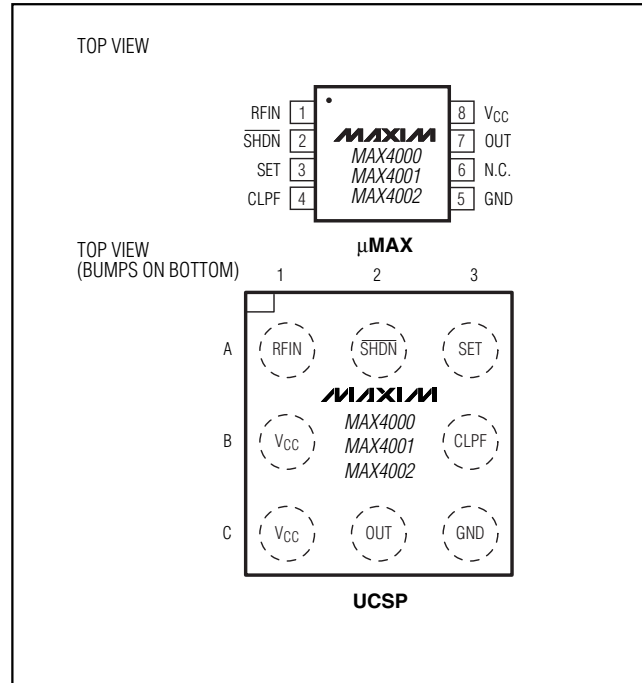

### Chip Information

TRANSISTOR COUNT: 358

PROCESS: Bipolar



# 2.5GHz 45dB RF-Detecting Controllers

## Package Information

(The package drawing(s) in this data sheet may not reflect the most current specifications. For the latest package outline information, go to [www.maxim-ic.com/packages](http://www.maxim-ic.com/packages).)

MAX4000/MAX4001/MAX4002

9LUCSP, 3x3EFS

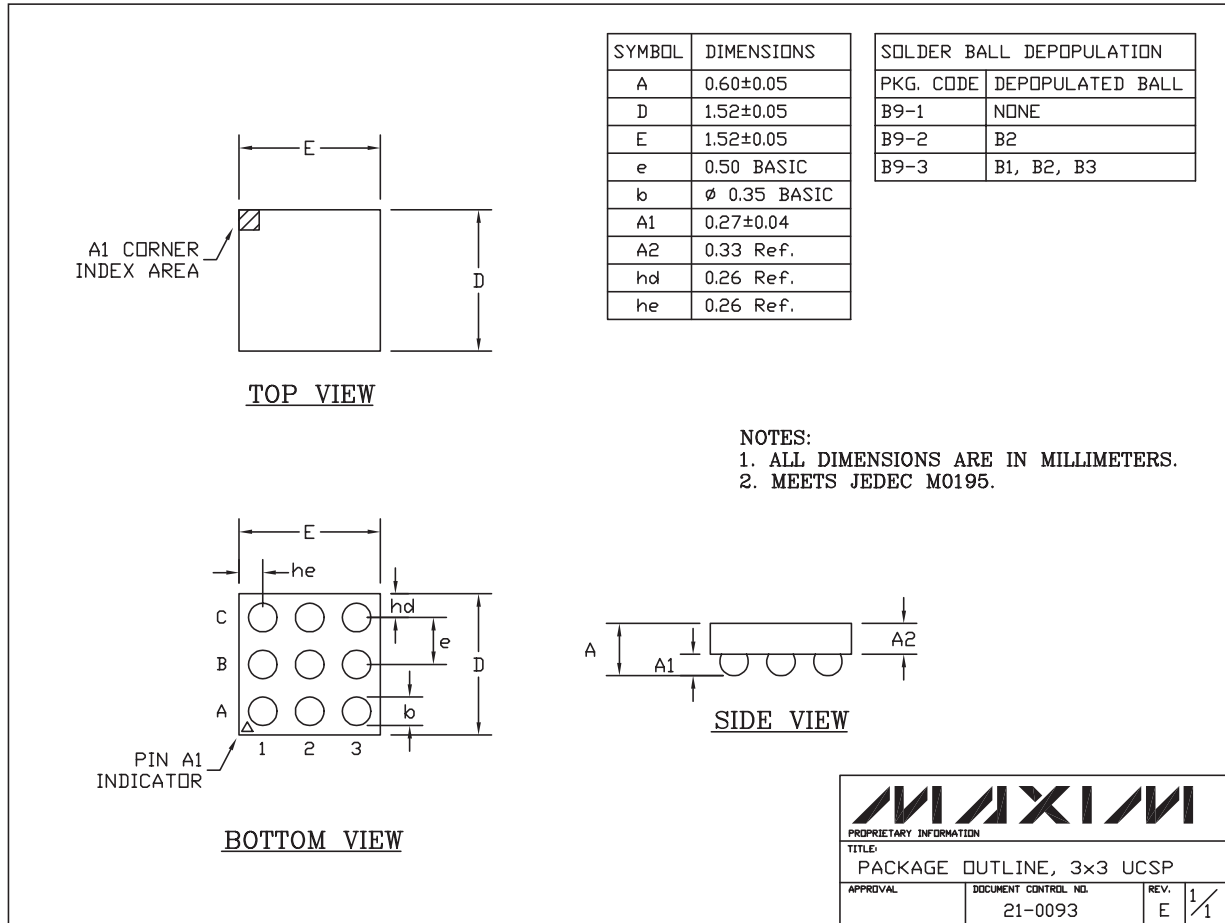

# 2.5GHz 45dB RF-Detecting Controllers

## Package Information (continued)

(The package drawing(s) in this data sheet may not reflect the most current specifications. For the latest package outline information, go to [www.maxim-ic.com/packages](http://www.maxim-ic.com/packages).)

| DIM      | INCHES      |             | MILLIMETERS |             |
|----------|-------------|-------------|-------------|-------------|
|          | MIN         | MAX         | MIN         | MAX         |
| A        | -           | 0.043       | -           | 1.10        |
| A1       | 0.002       | 0.006       | 0.05        | 0.15        |
| A2       | 0.030       | 0.037       | 0.75        | 0.95        |
| b        | 0.010       | 0.014       | 0.25        | 0.36        |
| c        | 0.005       | 0.007       | 0.13        | 0.18        |
| D        | 0.116       | 0.120       | 2.95        | 3.05        |
| e        | 0.0256 BSC  |             | 0.65 BSC    |             |
| E        | 0.116       | 0.120       | 2.95        | 3.05        |
| H        | 0.188       | 0.198       | 4.78        | 5.03        |
| L        | 0.016       | 0.026       | 0.41        | 0.66        |
| $\alpha$ | 0 $^\infty$ | 6 $^\infty$ | 0 $^\infty$ | 6 $^\infty$ |
| S        | 0.0207 BSC  |             | 0.5250 BSC  |             |

**NOTES:**  
 1. D&E DO NOT INCLUDE MOLD FLASH.  
 2. MOLD FLASH OR PROTRUSIONS NOT TO EXCEED 0.15MM (.006").  
 3. CONTROLLING DIMENSION: MILLIMETERS.  
 4. MEETS JEDEC MO-187C-AA.

|                                                        |                                                |                          |     |
|--------------------------------------------------------|------------------------------------------------|--------------------------|-----|
|                                                        |                                                |                          |     |
| <small>PROPRIETARY INFORMATION</small>                 |                                                |                          |     |
| <small>TITLE:</small><br>PACKAGE OUTLINE, 8L uMAX/uSOP |                                                |                          |     |
| <small>APPROVAL</small>                                | <small>DOCUMENT CONTROL NO.</small><br>21-0036 | <small>REV.</small><br>J | 1/1 |

R111MAX1.EPS

Maxim cannot assume responsibility for use of any circuitry other than circuitry entirely embodied in a Maxim product. No circuit patent licenses are implied. Maxim reserves the right to change the circuitry and specifications without notice at any time.

18 **Maxim Integrated Products, 120 San Gabriel Drive, Sunnyvale, CA 94086 408-737-7600**