

TLV27x Family of 550- μ A/Ch, 3-MHz, Rail-to-Rail Output Operational Amplifiers

1 Features

- Rail-to-Rail Output
- Wide Bandwidth: 3 MHz
- High Slew Rate: 2.4 V/ μ s
- Supply Voltage Range: 2.7 V to 16 V
- Supply Current: 550 μ A/Channel
- Input Noise Voltage: 39 nV/ $\sqrt{\text{Hz}}$
- Input Bias Current: 1 pA
- Specified Temperature Range:
 - Commercial Grade: 0°C to 70°C
 - Industrial Grade: -40°C to 125°C
- Ultrasmall Packaging:
 - 5-Pin SOT-23 (TLV271)
 - 8-Pin MSOP (TLV272)
- Ideal Upgrade for TLC72x Family

2 Applications

- E-Bike
- Power Banks
- Smoke detectors
- Solar Inverters
- Low-Power Motor Controls
- Battery-Powered Instruments
- Building Automation

Operational Amplifier

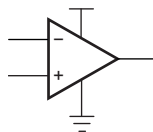

Copyright © 2016,
Texas Instruments Incorporated

3 Description

Operating from 2.7 V to 16 V over the extended industrial temperature range from -40°C to +125°C, the TLV27x is a low power, wide bandwidth operational amplifier (opamp) with rail to rail output. This makes it an ideal alternative to the TLC27x family for applications where rail-to-rail output swings are essential. The TLV27x provides 3-MHz bandwidth from only 550 μ A.

Like the TLC27x, the TLV27x is fully specified for 5-V and \pm 5-V supplies. The maximum recommended supply voltage is 16 V, which allows the devices to be operated from a variety of rechargeable cells (\pm 8 V supplies down to \pm 1.35 V).

The CMOS inputs enable use in high-impedance sensor interfaces, with the lower voltage operation making an attractive alternative for the TLC27x in battery-powered applications.

All members are available in PDIP and SOIC with the singles in the small SOT-23 package, duals in the MSOP, and quads in the TSSOP package.

The 2.7-V operation makes it compatible with Li-Ion powered systems and the operating supply voltage range of many micropower microcontrollers available today including TI's [MSP430](#).

Device Information⁽¹⁾

PART NUMBER	PACKAGE	BODY SIZE (NOM)
TLV271	SOIC (8)	4.98 mm x 3.91 mm
	SOT-23 (5)	2.90 mm x 1.60 mm
	PDIP (8)	9.81 mm x 6.35 mm
TLV272	SOIC (8)	4.98 mm x 3.91 mm
	PDIP (8)	9.81 mm x 6.35 mm
	VSSOP (8)	3.00 mm x 3.00 mm
TLV274	SOIC (14)	8.65 mm x 3.91 mm
	PDIP (14)	3.90 mm x 6.35 mm
	TSSOP (14)	5.00 mm x 4.40 mm

(1) For all available packages, see the orderable addendum at the end of the data sheet.



Table of Contents

1	Features	1	8.1	Overview	16
2	Applications	1	8.2	Functional Block Diagram	16
3	Description	1	8.3	Feature Description	17
4	Revision History	2	8.4	Device Functional Modes	17
5	Device Comparison Table	3	9	Application and Implementation	18
6	Pin Configuration and Functions	4	9.1	Application Information	18
7	Specifications	6	9.2	Typical Application	18
7.1	Absolute Maximum Ratings	6	9.3	System Examples	19
7.2	Recommended Operating Conditions	6	10	Power Supply Recommendations	21
7.3	Thermal Information: TLV271	7	11	Layout	21
7.4	Thermal Information: TLV272	7	11.1	Layout Guidelines	21
7.5	Thermal Information: TLV274	7	11.2	Layout Example	22
7.6	Electrical Characteristics: DC Characteristics	8	12	Device and Documentation Support	23
7.7	Electrical Characteristics: Input Characteristics	8	12.1	Documentation Support	23
7.8	Electrical Characteristics: Output Characteristics	9	12.2	Related Links	23
7.9	Electrical Characteristics: Power Supply	10	12.3	Receiving Notification of Documentation Updates	23
7.10	Electrical Characteristics: Dynamic Performance	10	12.4	Community Resource	23
7.11	Electrical Characteristics: Noise/Distortion Performance	10	12.5	Trademarks	23
7.12	Typical Characteristics	11	12.6	Electrostatic Discharge Caution	23
8	Detailed Description	16	12.7	Glossary	24
			13	Mechanical, Packaging, and Orderable Information	24

4 Revision History

NOTE: Page numbers for previous revisions may differ from page numbers in the current version.

Changes from Revision D (February 2004) to Revision E	Page
• Added <i>Feature Description</i> section, <i>Device Functional Modes</i> , <i>Application and Implementation</i> section, <i>Power Supply Recommendations</i> section, <i>Layout</i> section, <i>Device and Documentation Support</i> section, and <i>Mechanical, Packaging, and Orderable Information</i> section	1
• Deleted <i>Continuous total power dissipation</i> parameter from <i>Absolute Maximum Ratings</i>	6
• Deleted <i>Dissipation Ratings</i> table	7
• Deleted <i>Macromodel Information</i>	21

5 Device Comparison Table

DEVICE ⁽¹⁾	V _{DD} (V)	V _{IO} (μV)	I _Q /Ch (μA)	I _B (pA)	GBW (MHz)	SR (V/μs)	SHUTDOWN	RAIL-TO-RAIL	SINGLES/ DUALS/ QUADS
TLV27x	2.7 to 16	500	550	1	3	2.4	—	O	S/D/Q
TLC27x	3 to 16	1100	675	1	1.7	3.6	—	—	S/D/Q
TLV237x	2.7 to 16	500	550	1	3	2.4	Yes	I/O	S/D/Q
TLC227x	2.7 to 16	300	1100	1	2.2	3.6	—	O	D/Q
TLV246x	2.7 to 6	150	550	1300	6.4	1.6	Yes	I/O	S/D/Q
TLV247x	2.7 to 6	250	600	2	2.8	1.5	Yes	I/O	S/D/Q
TLV244x	2.7 to 10	300	725	1	1.8	1.4	—	O	D/Q

(1) Typical values measured at 5 V, 25°C.

6 Pin Configuration and Functions

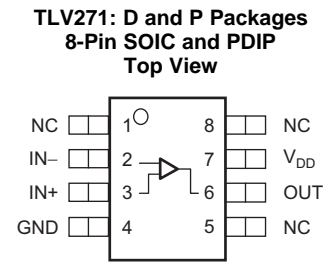
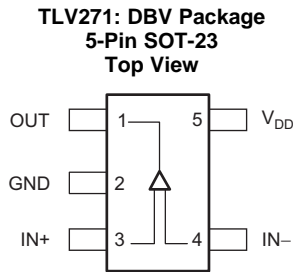

Pin Functions

NAME	PIN		I/O	DESCRIPTION
	TLV271			
	SOT-23	SOIC PDIP		
GND	2	4	—	Negative (lowest) supply or ground (for single-supply operation)
IN-	4	2	I	Negative (inverting) input
IN+	3	3	I	Positive (noninverting) input
NC	—	1, 5, 8	—	No internal connection (can be left floating)
OUT	1	6	O	Output
V _{DD}	5	7	—	Positive (highest) supply

**TLV272: D, DGK, and P Packages
8-Pin SOIC, VSSOP, and PDIP
Top View**

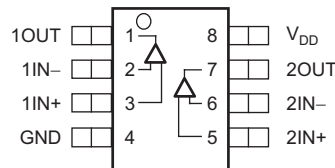

Pin Functions

NAME	PIN		I/O	DESCRIPTION
	TLV272			
	SOIC VSSOP PDIP			
GND	4	—	—	Negative (lowest) supply or ground (for single-supply operation)
1IN-	2	I	I	Inverting input, channel 1
1IN+	3	I	I	Noninverting input, channel 1
2IN-	6	I	I	Inverting input, channel 2
2IN+	5	I	I	Noninverting input, channel 2
1OUT	1	O	O	Output, channel 1
2OUT	7	O	O	Output, channel 2
V _{DD}	8	—	—	Positive (highest) supply

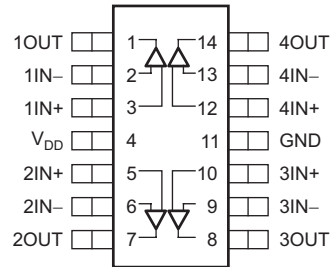
**TLV274: D, PW, and N Packages
14-Pin SOIC, TSSOP, and PDIP
Top View**

Pin Functions

PIN		I/O	DESCRIPTION
NAME	TLV274 SOIC TSSOP PDIP		
GND	11	—	Negative supply or ground (for single-supply operation)
1IN–	2	I	Inverting input, channel 1
1IN+	3	I	Noninverting input, channel 1
2IN–	6	I	Inverting input, channel 2
2IN+	5	I	Noninverting input, channel 2
3IN–	9	I	Inverting input, channel 3
3IN+	10	I	Noninverting input, channel 3
4IN–	13	I	Inverting input, channel 4
4IN+	12	I	Noninverting input, channel 4
1OUT	1	O	Output, channel 1
2OUT	7	O	Output, channel 2
3OUT	8	O	Output, channel 3
4OUT	14	O	Output, channel 4
V _{DD}	4	—	Positive supply

7 Specifications

7.1 Absolute Maximum Ratings

over operating free-air temperature range (unless otherwise noted)⁽¹⁾

		MIN	MAX	UNIT	
Voltage	Supply, V_{DD}		16.5	V	
	Differential input, V_{ID}	$-V_{DD}$	V_{DD}	V	
	Input, V_I	-0.2	$V_{DD} + 0.2$	V	
Current	Input, I_I	-10	10	mA	
	Output, I_O	-100	100	mA	
Temperature	Operating, T_A	C-suffix	0	70	°C
		I-suffix	-40	125	°C
	Junction, T_J		150	°C	
	Storage, T_{stg}	-65	150	°C	

(1) Stresses beyond those listed under *Absolute Maximum Ratings* may cause permanent damage to the device. These are stress ratings only, which do not imply functional operation of the device at these or any other conditions beyond those indicated under *Recommended Operating Conditions*. Exposure to absolute-maximum-rated conditions for extended periods may affect device reliability. All voltage values, except differential voltages, are with respect to GND.

7.2 Recommended Operating Conditions

over operating free-air temperature range (unless otherwise noted)

		MIN	NOM	MAX	UNIT
Supply voltage, V_{DD}	Single-supply	2.7		16	V
	Split-supply	± 1.35		± 8	
Common-mode input voltage, V_{ICR}		0		$V_{DD} - 1.35$	V
Operating free-air temperature, T_A	C-suffix	0		70	°C
	I-suffix	-40		125	

7.3 Thermal Information: TLV271

THERMAL METRIC ⁽¹⁾		TLV271			UNIT
		D (SOIC)	DBV (SOT-23)	P (PDIP)	
		8 PINS	5 PINS	8 PINS	
$R_{\theta JA}$	Junction-to-ambient thermal resistance	127.2	221.7	49.2	°C/W
$R_{\theta JC(top)}$	Junction-to-case (top) thermal resistance	71.6	144.7	39.4	°C/W
$R_{\theta JB}$	Junction-to-board thermal resistance	68.2	49.7	26.4	°C/W
Ψ_{JT}	Junction-to-top characterization parameter	22	26.1	15.4	°C/W
Ψ_{JB}	Junction-to-board characterization parameter	67.6	49	26.3	°C/W
$R_{\theta JC(bot)}$	Junction-to-case (bottom) thermal resistance	n/a	n/a	n/a	°C/W

(1) For more information about traditional and new thermal metrics, see the [Semiconductor and IC Package Thermal Metrics](#) application report.

7.4 Thermal Information: TLV272

THERMAL METRIC ⁽¹⁾		TLV272			UNIT
		D (SOIC)	DGK (VSSOP)	P (PDIP)	
		8 PINS	8 PINS	8 PINS	
$R_{\theta JA}$	Junction-to-ambient thermal resistance	127.2	186.6	49.2	°C/W
$R_{\theta JC(top)}$	Junction-to-case (top) thermal resistance	71.6	78.8	39.4	°C/W
$R_{\theta JB}$	Junction-to-board thermal resistance	68.2	107.9	26.4	°C/W
Ψ_{JT}	Junction-to-top characterization parameter	22	15.5	15.4	°C/W
Ψ_{JB}	Junction-to-board characterization parameter	67.6	106.3	26.3	°C/W
$R_{\theta JC(bot)}$	Junction-to-case (bottom) thermal resistance	n/a	n/a	n/a	°C/W

(1) For more information about traditional and new thermal metrics, see the [Semiconductor and IC Package Thermal Metrics](#) application report.

7.5 Thermal Information: TLV274

THERMAL METRIC ⁽¹⁾		TLV274			UNIT
		D (SOIC)	N (PDIP)	PW (TSSOP)	
		14 PINS	14 PINS	14 PINS	
$R_{\theta JA}$	Junction-to-ambient thermal resistance	97	66.3	135	°C/W
$R_{\theta JC(top)}$	Junction-to-case (top) thermal resistance	56	20.5	45	°C/W
$R_{\theta JB}$	Junction-to-board thermal resistance	53	26.8	66	°C/W
Ψ_{JT}	Junction-to-top characterization parameter	19	2.1	n/a	°C/W
Ψ_{JB}	Junction-to-board characterization parameter	46	26.2	60	°C/W
$R_{\theta JC(bot)}$	Junction-to-case (bottom) thermal resistance	n/a	n/a	n/a	°C/W

(1) For more information about traditional and new thermal metrics, see the [Semiconductor and IC Package Thermal Metrics](#) application report.

7.6 Electrical Characteristics: DC Characteristics

 at specified free-air temperature, $V_{DD} = 2.7\text{ V}$, 5 V , and $\pm 5\text{ V}$ (unless otherwise noted)

PARAMETER		TEST CONDITIONS		$T_A^{(1)}$	MIN	TYP	MAX	UNIT
V_{IO}	Input offset voltage	$V_{IC} = V_{DD}/2$, $R_L = 10\text{ k}\Omega$, $V_O = V_{DD}/2$, $R_S = 50\ \Omega$		25°C		0.5	5	mV
				Full range			7	
αV_{IO}	Offset voltage drift			25°C		2		$\mu\text{V}/^\circ\text{C}$
CMRR	Common-mode rejection ratio	$V_{IC} = 0\text{ to }V_{DD} - 1.35\text{ V}$, $R_S = 50\ \Omega$	$V_{DD} = 2.7\text{ V}$	25°C	58	70	dB	
				Full range	55			
		$V_{DD} = 5\text{ V}$	25°C	65	80			
			Full range	62				
		$V_{DD} = \pm 5\text{ V}$	25°C	69	85			
			Full range	66				
A_{VD}	Large-signal differential voltage amplification	$V_{O(PP)} = V_{DD}/2$, $R_L = 10\text{ k}\Omega$	$V_{DD} = 2.7\text{ V}$	25°C	97	106	dB	
				Full range	76			
			$V_{DD} = 5\text{ V}$	25°C	100	110		
				Full range	86			
			$V_{DD} = \pm 5\text{ V}$	25°C	100	115		
				Full range	90			

(1) Full range is 0°C to 70°C for C-suffix and full range is –40°C to 125°C for I-suffix. If not specified, full range is –40°C to 125°C.

7.7 Electrical Characteristics: Input Characteristics

 at specified free-air temperature, $V_{DD} = 2.7\text{ V}$, 5 V , and $\pm 5\text{ V}$ (unless otherwise noted).

PARAMETER	TEST CONDITIONS	T_A	MIN	TYP	MAX	UNIT
I_{IO}	$V_{DD} = 5\text{ V}$, $V_{IC} = V_{DD}/2$, $V_O = V_{DD}/2$, $R_S = 50\ \Omega$	25°C		1	60	pA
		70°C			100	
		125°C			1000	
I_{IB}	$V_{DD} = 5\text{ V}$, $V_{IC} = V_{DD}/2$, $V_O = V_{DD}/2$, $R_S = 50\ \Omega$	25°C		1	60	pA
		70°C			100	
		125°C			1000	
$r_{i(d)}$	Differential input resistance	25°C		1000		G Ω
C_{IC}	Common-mode input capacitance	$f = 21\text{ kHz}$		8		pF

7.8 Electrical Characteristics: Output Characteristics

 at specified free-air temperature, $V_{DD} = 2.7\text{ V}$, 5 V , and $\pm 5\text{ V}$ (unless otherwise noted).

PARAMETER	TEST CONDITIONS		T_A	MIN	TYP	MAX	UNIT
V_{OH} High-level output voltage	$V_{IC} = V_{DD}/2$, $I_{OH} = -1\text{ mA}$	$V_{DD} = 2.7\text{ V}$	25°C	2.55	2.58		V
			Full range	2.48			
		$V_{DD} = 5\text{ V}$	25°C	4.9	4.93		
			Full range	4.85			
		$V_{DD} = \pm 5\text{ V}$	25°C	4.92	4.96		
			Full range	4.9			
	$V_{IC} = V_{DD}/2$, $I_{OH} = -5\text{ mA}$	$V_{DD} = 2.7\text{ V}$	25°C	1.9	2.1		
			Full range	1.5			
		$V_{DD} = 5\text{ V}$	25°C	4.6	4.68		
			Full range	4.5			
		$V_{DD} = \pm 5\text{ V}$	25°C	4.7	4.84		
			Full range	4.65			
V_{OL} Low-level output voltage	$V_{IC} = V_{DD}/2$, $I_{OH} = 1\text{ mA}$	$V_{DD} = 2.7\text{ V}$	25°C		0.1	0.15	V
			Full range			0.22	
		$V_{DD} = 5\text{ V}$	25°C		0.05	0.1	
			Full range			0.15	
		$V_{DD} = \pm 5\text{ V}$	25°C		-4.95	-4.92	
			Full range			-4.9	
	$V_{IC} = V_{DD}/2$, $I_{OH} = 5\text{ mA}$	$V_{DD} = 2.7\text{ V}$	25°C		0.5	0.7	
			Full range			1.1	
		$V_{DD} = 5\text{ V}$	25°C		0.28	0.4	
			Full range			0.5	
		$V_{DD} = \pm 5\text{ V}$	25°C		-4.84	-4.7	
			Full range			-4.65	
I_O Output current	$V_O = 0.5\text{ V}$ from rail, $V_{DD} = 2.7\text{ V}$	Positive rail	25°C		4	mA	
		Negative rail	25°C		5		
	$V_O = 0.5\text{ V}$ from rail, $V_{DD} = 5\text{ V}$	Positive rail	25°C		7		
		Negative rail	25°C		8		
	$V_O = 0.5\text{ V}$ from rail, $V_{DD} = 10\text{ V}$	Positive rail	25°C		13		
		Negative rail	25°C		12		

7.9 Electrical Characteristics: Power Supply

 at specified free-air temperature, $V_{DD} = 2.7\text{ V}$, 5 V , and $\pm 5\text{ V}$ (unless otherwise noted).

PARAMETER		TEST CONDITIONS		$T_A^{(1)}$	MIN	TYP	MAX	UNIT
I_{DD}	Supply current (per channel)	$V_O = V_{DD}/2$	$V_{DD} = 2.7\text{ V}$	25°C		470	560	μA
			$V_{DD} = 5\text{ V}$	25°C		550	660	
			$V_{DD} = 10\text{ V}$	25°C		625	800	
				Full range			1000	
PSRR	Supply voltage rejection ratio ($\Delta V_{DD} / \Delta V_{IO}$)	$V_{DD} = 2.7\text{ V}$ to 16 V , $V_{IC} = V_{DD}/2$, no load		25°C	70	80		dB
				Full range	65			

(1) Full range is 0°C to 70°C for C-suffix and full range is –40°C to 125°C for I-suffix. If not specified, full range is –40°C to 125°C.

7.10 Electrical Characteristics: Dynamic Performance

over operating free-air temperature range (unless otherwise noted).

PARAMETER		TEST CONDITIONS		$T_A^{(1)}$	MIN	TYP	MAX	UNIT
UGBW	Unity-gain bandwidth	$R_L = 2\text{ k}\Omega$, $C_L = 10\text{ pF}$	$V_{DD} = 2.7\text{ V}$	25°C		2.4		MHz
			$V_{DD} = 5\text{ V}$ to 10 V	25°C		3		
SR	Slew rate at unity gain	$V_{O(PP)} = V_{DD}/2$, $C_L = 50\text{ pF}$, $R_L = 10\text{ k}\Omega$	$V_{DD} = 2.7\text{ V}$	25°C	1.35	2.1		$\text{V}/\mu\text{s}$
				Full range	1			
			$V_{DD} = 5\text{ V}$	25°C	1.45	2.4		$\text{V}/\mu\text{s}$
				Full range	1.2			
			$V_{DD} = \pm 5\text{ V}$	25°C	1.8	2.6		$\text{V}/\mu\text{s}$
				Full range	1.3			
ϕ_m	Phase margin	$R_L = 2\text{ k}\Omega$	$C_L = 10\text{ pF}$	25°C		65		°
	Gain margin	$R_L = 2\text{ k}\Omega$	$C_L = 10\text{ pF}$	25°C		18		dB
t_s	Setting time	$V_{DD} = 2.7\text{ V}$, $V_{(STEP)PP} = 1\text{ V}$, $A_V = -1$, $C_L = 10\text{ pF}$, $R_L = 2\text{ k}\Omega$	0.1%	25°C		2.9		μs
			0.1%			2		
		$V_{DD} = 5\text{ V}$, $\pm 5\text{ V}$, $V_{(STEP)PP} = 1\text{ V}$, $A_V = -1$, $C_L = 47\text{ pF}$, $R_L = 2\text{ k}\Omega$						

(1) Full range is 0°C to 70°C for C suffix and full range is –40°C to 125°C for I suffix. If not specified, full range is –40°C to 125°C.

7.11 Electrical Characteristics: Noise/Distortion Performance

over operating free-air temperature range (unless otherwise noted).

PARAMETER		TEST CONDITIONS		T_A	MIN	TYP	MAX	UNIT
THD + N	Total harmonic distortion plus noise	$V_{DD} = 2.7\text{ V}$, $V_{O(PP)} = V_{DD}/2\text{ V}$, $R_L = 2\text{ k}\Omega$, $f = 10\text{ kHz}$	$A_V = 1$	25°C		0.02%		
			$A_V = 10$			0.05%		
			$A_V = 100$			0.18%		
		$V_{DD} = 5\text{ V}$, $\pm 5\text{ V}$, $V_{O(PP)} = V_{DD}/2\text{ V}$, $R_L = 2\text{ k}\Omega$, $f = 10\text{ kHz}$	$A_V = 1$	25°C		0.02%		
			$A_V = 10$			0.09%		
			$A_V = 100$			0.5%		
V_n	Equivalent input noise voltage	$f = 1\text{ kHz}$	25°C			39	$\text{nV}/\sqrt{\text{Hz}}$	
		$f = 10\text{ kHz}$				35		
I_n	Equivalent input noise current	$f = 1\text{ kHz}$	25°C			0.6	$\text{fA}/\sqrt{\text{Hz}}$	

7.12 Typical Characteristics

Table 1. Table of Graphs

DESCRIPTION		FIGURE NO.	
CMRR	Common-mode rejection ratio	vs Frequency	Figure 1
	Input bias and offset current	vs Free-air temperature	Figure 2
V_{OL}	Low-level output voltage	vs Low-level output current	Figure 3 , Figure 5 , Figure 7
V_{OH}	High-level output voltage	vs High-level output current	Figure 4 , Figure 6 , Figure 8
$V_{O(PP)}$	Peak-to-peak output voltage	vs Frequency	Figure 9
I_{DD}	Supply current	vs Supply voltage	Figure 10
PSRR	Power-supply rejection ratio	vs Frequency	Figure 11
A_{VD}	Differential voltage gain and phase	vs Frequency	Figure 12
	Gain-bandwidth product	vs Free-air temperature	Figure 13
SR	Slew rate	vs Supply voltage	Figure 14
		vs Free-air temperature	Figure 15
ϕ_m	Phase margin	vs Capacitive load	Figure 16
V_n	Equivalent input noise voltage	vs Frequency	Figure 17
	Voltage-follower large-signal pulse response		Figure 18 , Figure 19
	Voltage-follower small-signal pulse response		Figure 20
	Inverting large-signal response		Figure 21 , Figure 22
	Inverting small-signal response		Figure 23
	Crosstalk	vs Frequency	Figure 24

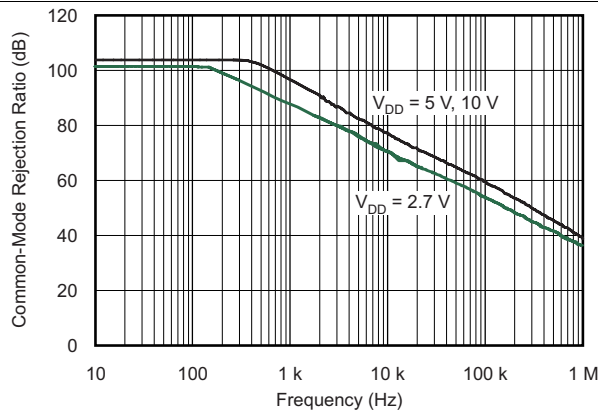

Figure 1. Common-Mode Rejection Ratio vs Frequency

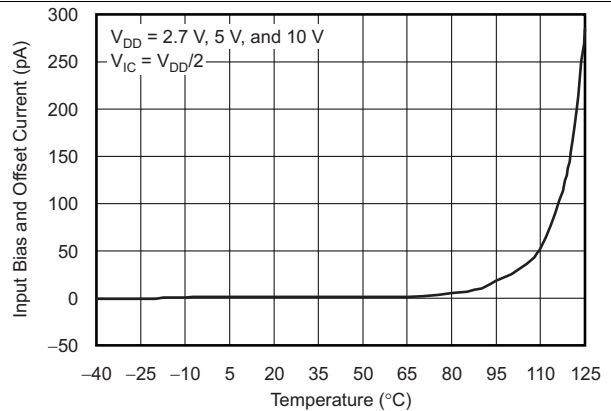

Figure 2. Input Bias and Offset Current vs Free-Air Temperature

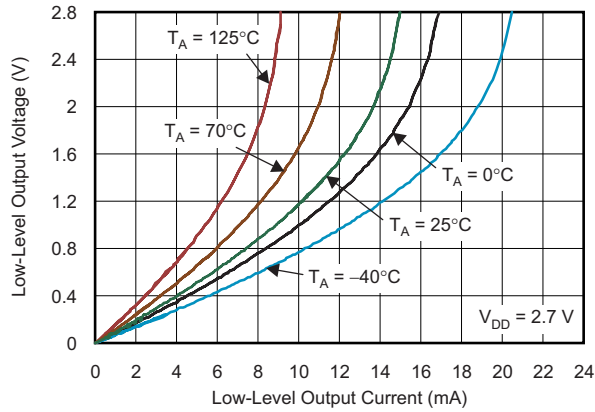

Figure 3. Low-Level Output Voltage vs Low-Level Output Current

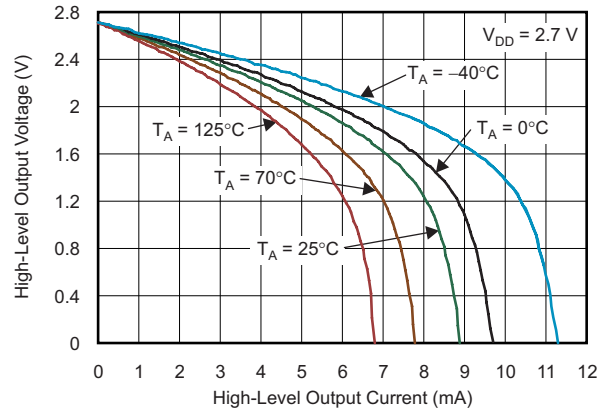

Figure 4. High-Level Output Voltage vs High-Level Output Current

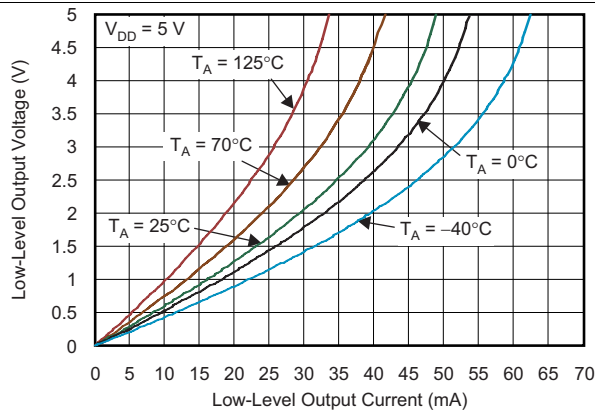

Figure 5. Low-Level Output Voltage vs Low-Level Output Current

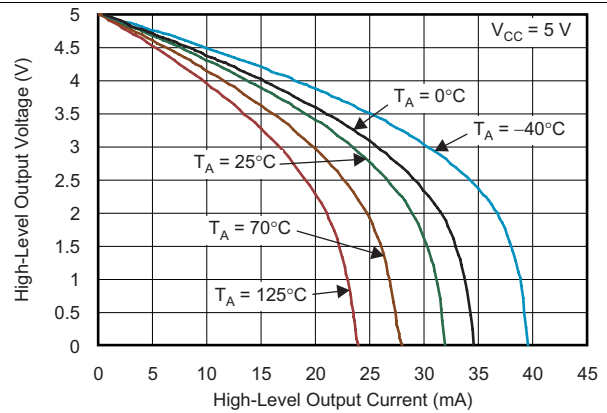

Figure 6. High-Level Output Voltage vs High-Level Output Current

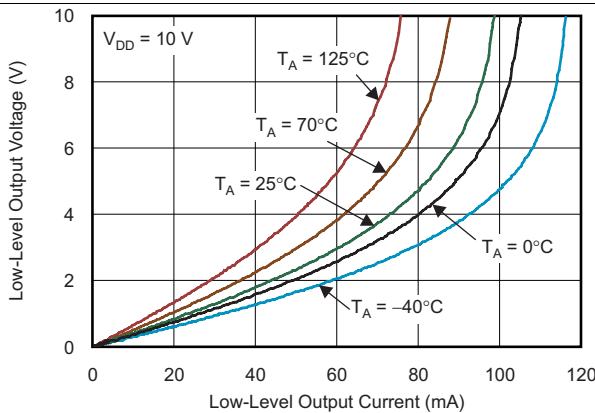

Figure 7. Low-Level Output Voltage vs Low-Level Output Current

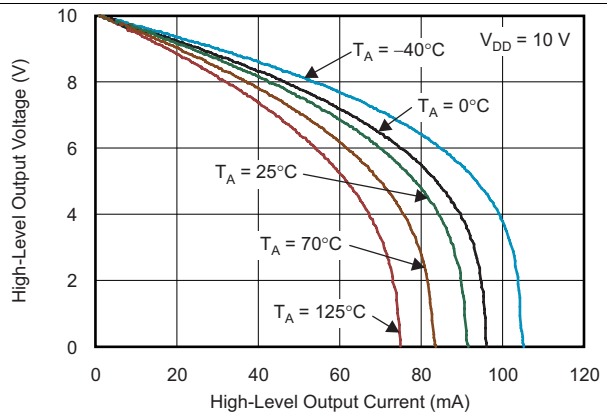

Figure 8. High-Level Output Voltage vs High-Level Output Current

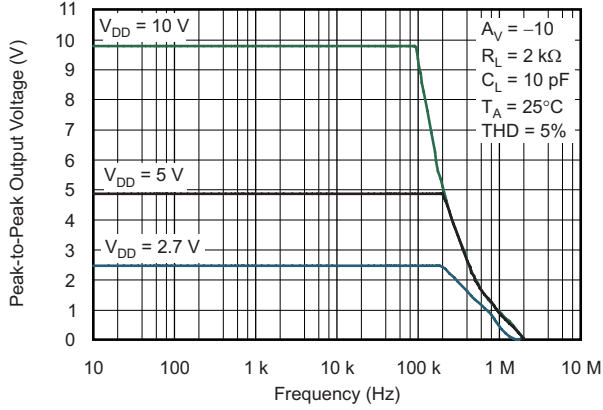

Figure 9. Peak-to-Peak Output Voltage vs Frequency

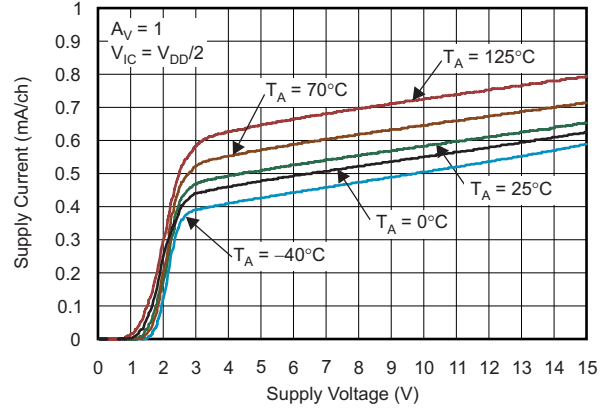

Figure 10. Supply Current vs Supply Voltage

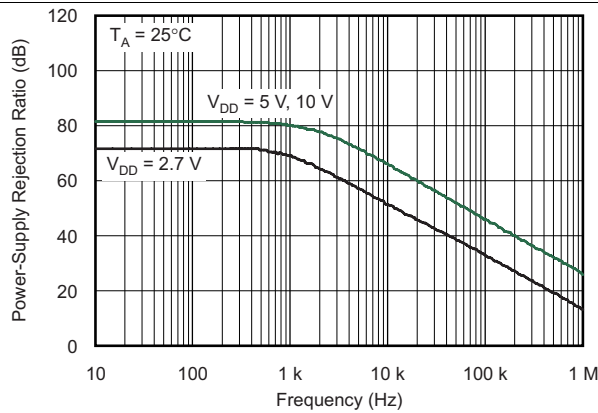

Figure 11. Power-Supply Rejection Ratio vs Frequency

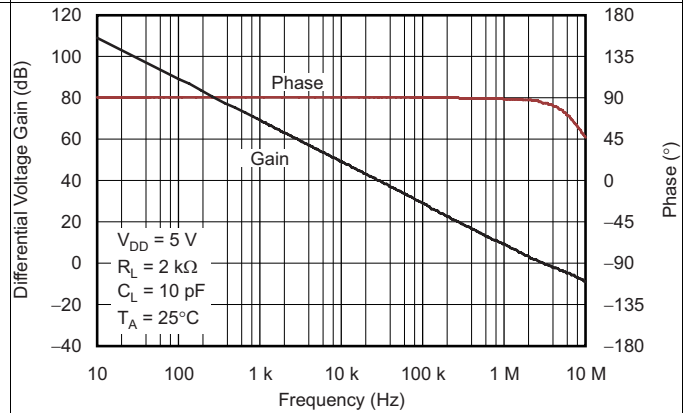

Figure 12. Differential Voltage Gain and Phase

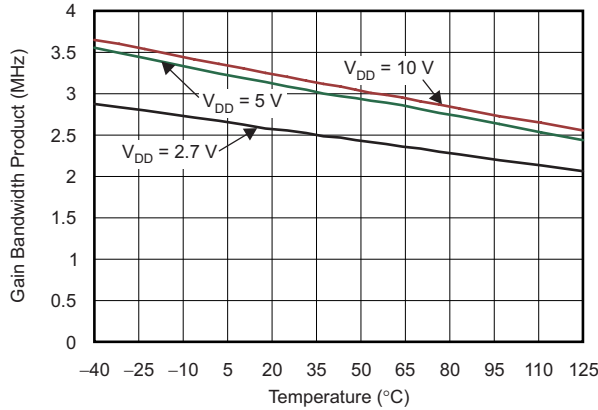

Figure 13. Gain Bandwidth Product vs Free-Air Temperature

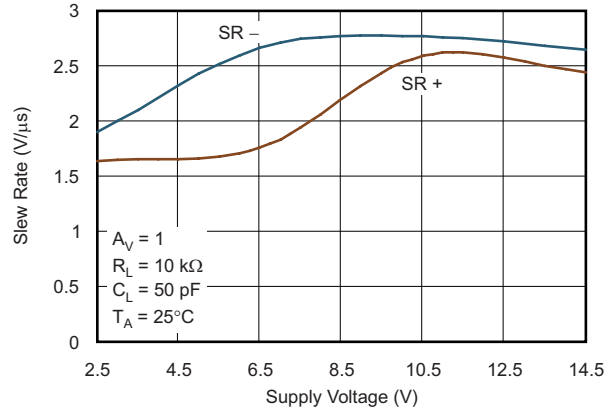

Figure 14. Slew Rate vs Supply Voltage

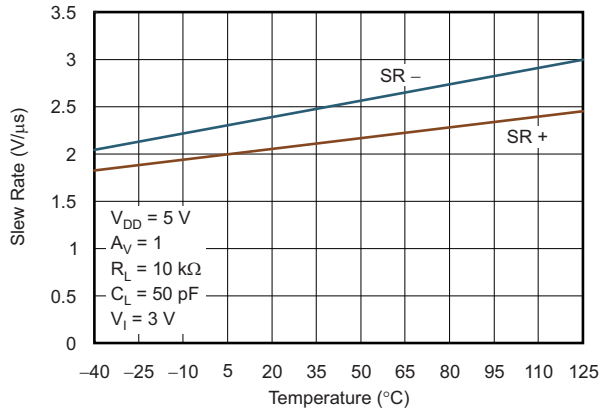

Figure 15. Slew Rate vs Free-Air Temperature

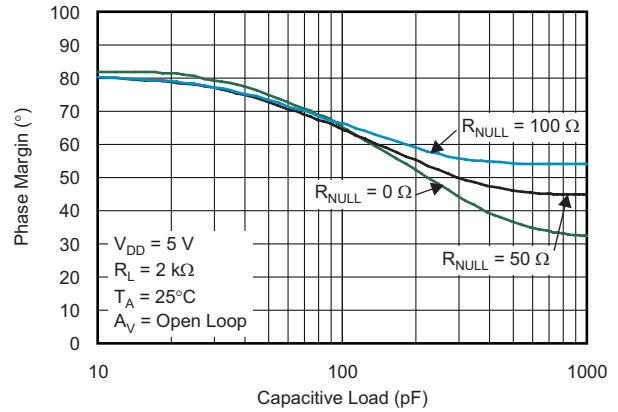

Figure 16. Phase Margin vs Capacitive Load

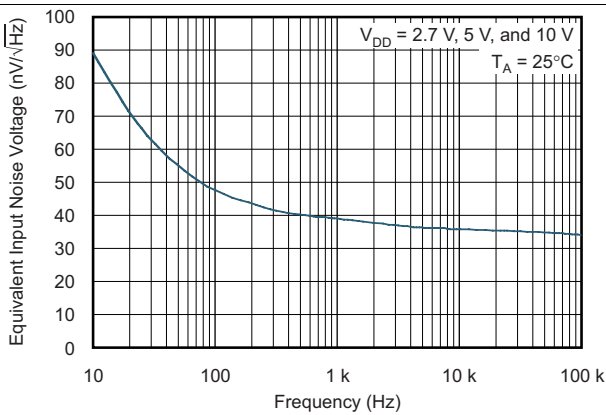

Figure 17. Equivalent Input Noise Voltage vs Frequency

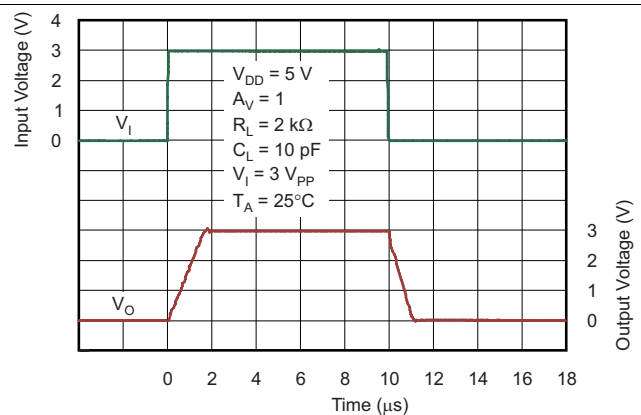

Figure 18. Voltage-Follower Large-Signal Pulse Response

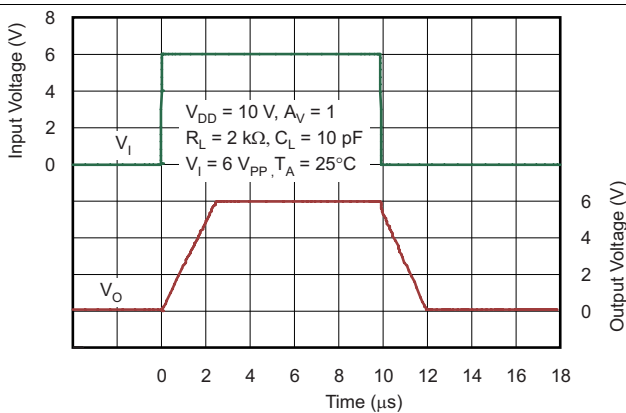

Figure 19. Voltage-Follower Large-Signal Pulse Response

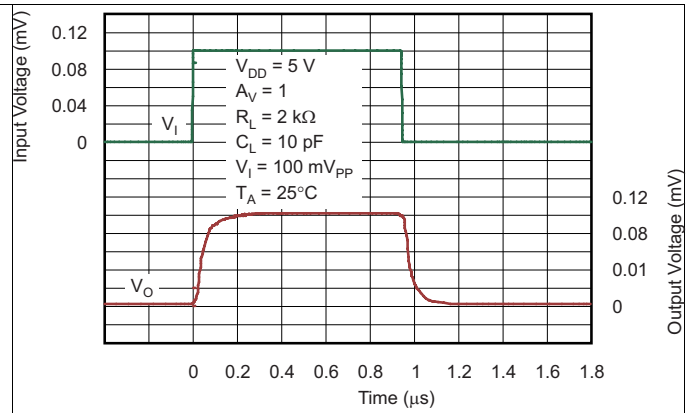
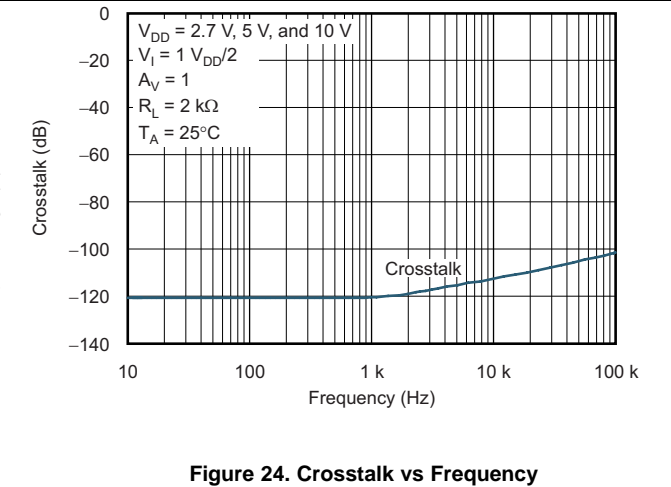
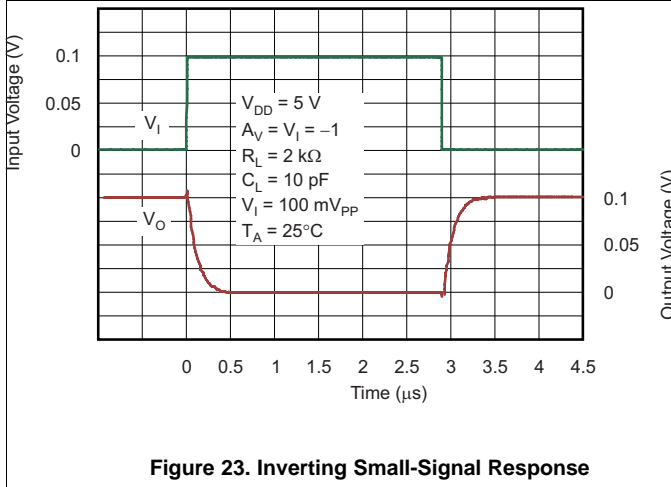
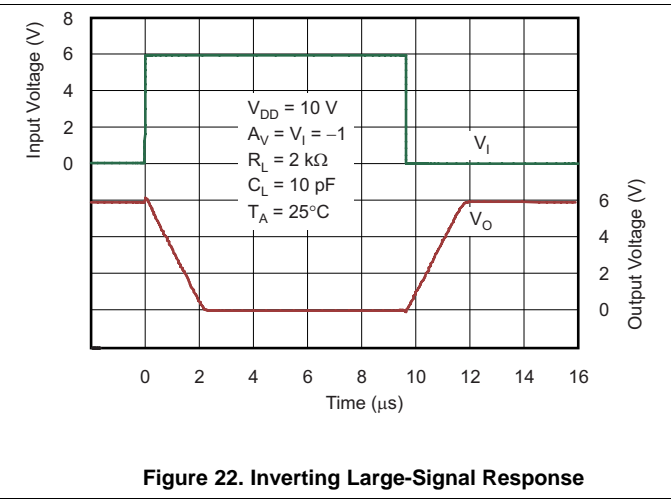
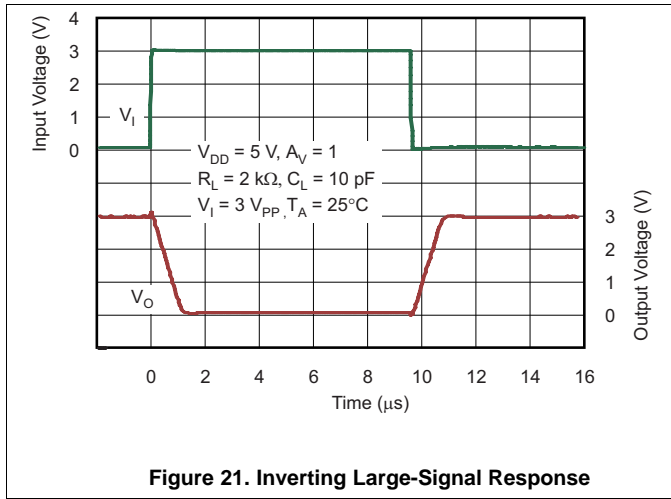

Figure 20. Voltage-Follower Small-Signal Pulse Response



8 Detailed Description

8.1 Overview

The TLV27x operates from a single power supply and consumes only 550 μA of quiescent current. With rail-to-rail output swing capability and 3-MHz bandwidth, the TLV27x is ideal for battery-powered and industrial applications.

8.2 Functional Block Diagram

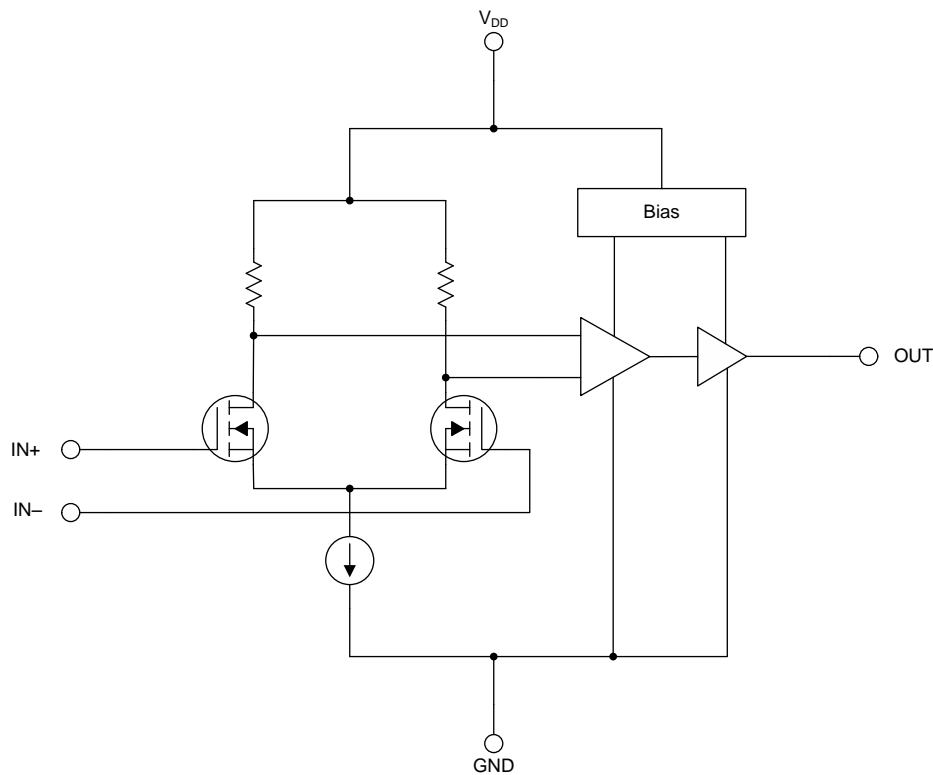

Copyright © 2016, Texas Instruments Incorporated

8.3 Feature Description

8.3.1 Rail to Rail Output

The TLV27x family of opamps features a rail to rail output stage. Rail to rail outputs allow for a wide dynamic range in low voltage systems. This feature along with low power and wide bandwidth make the TLV27x family suitable for portable and battery powered systems.

8.3.2 Offset Voltage

The output offset voltage (V_{OO}) is the sum of the input offset voltage (V_{IO}) and both input bias currents (I_{IB}) times the corresponding gains. Use the schematic in [Figure 25](#) and [Equation 1](#) to calculate the output offset voltage:

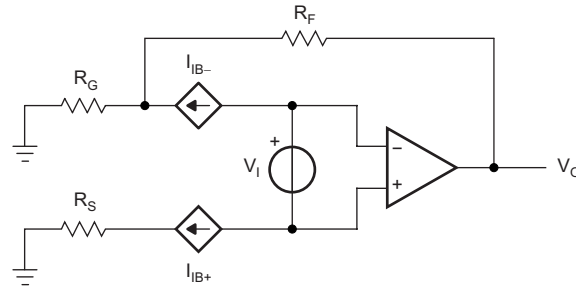

Copyright © 2016, Texas Instruments Incorporated

Figure 25. Output Offset Voltage Model

$$V_{OO} = V_{IO} \left[1 + \left(\frac{R_F}{R_G} \right) \right] \pm I_{IB+} R_S \left[1 + \left(\frac{R_F}{R_G} \right) \right] \pm I_{IB-} R_F \quad (1)$$

8.3.3 Driving a Capacitive Load

When the amplifier is configured in this manner, capacitive loading directly on the output decreases the device phase margin, leading to high frequency ringing or oscillations. Therefore, for capacitive loads of greater than 10 pF, TI recommends placing a resistor in series (R_{NULL}) with the output of the amplifier, as shown in [Figure 26](#). A minimum value of 20 Ω should work well for most applications.

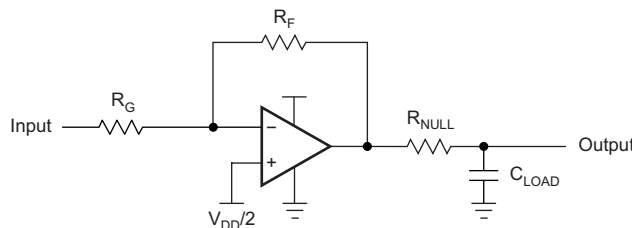

Copyright © 2016, Texas Instruments Incorporated

Figure 26. Driving a Capacitive Load

8.4 Device Functional Modes

The TLV27x has a single functional mode. It is operational when the power supply applied to the device is between 2.7 V (± 1.35 V) and 16 V (± 8 V). Electrical parameters that can vary with operating conditions are shown in [Typical Characteristics](#).

9 Application and Implementation

NOTE

Information in the following applications sections is not part of the TI component specification, and TI does not warrant its accuracy or completeness. TI's customers are responsible for determining suitability of components for their purposes. Customers should validate and test their design implementation to confirm system functionality.

9.1 Application Information

The TLV27x family offers outstanding DC and AC performance. These devices operate up to a 16-V power supply and offer ultra-low input bias current and 3-MHz bandwidth. These features make the TLV27x a robust operational amplifier for battery-powered and industrial applications.

9.2 Typical Application

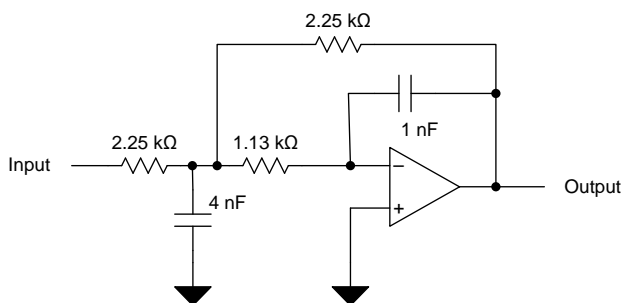

Figure 27. Second-Order, Low-Pass Filter

9.2.1 Design Requirements

- Gain = 1 V/V
- Low-pass cutoff frequency = 50 kHz
- –40-dB/dec filter response
- Maintain less than 3-dB gain peaking in the gain versus frequency response

9.2.2 Detailed Design Procedure

The infinite-gain multiple-feedback circuit for a low-pass network function is shown in [Figure 27](#). Use [Equation 2](#) to calculate the voltage transfer function.

$$\frac{\text{Output}}{\text{Input}}(s) = \frac{-1/R_1 R_3 C_2 C_5}{s^2 + (s/C_2)(1/R_1 + 1/R_3 + 1/R_4) + 1/R_3 R_4 C_2 C_5} \quad (2)$$

This circuit produces a signal inversion. For this circuit, the gain at DC and the low-pass cutoff frequency are calculated by [Equation 3](#):

$$\text{Gain} = \frac{R_4}{R_1}$$

$$f_c = \frac{1}{2\pi} \sqrt{(1/R_3 R_4 C_2 C_5)} \quad (3)$$

Typical Application (continued)

Software tools are readily available to simplify filter design. WEBENCH® Filter Designer is a simple, powerful, and easy-to-use active filter design program. The [WEBENCH® Filter Designer](#) lets you create optimized filter designs using a selection of TI operational amplifiers and passive components from TI's vendor partners.

Available as a web-based tool from the WEBENCH Design Center, WEBENCH Filter Designer allows you to design, optimize, and simulate complete multistage active filter solutions within minutes.

9.2.3 Application Curve

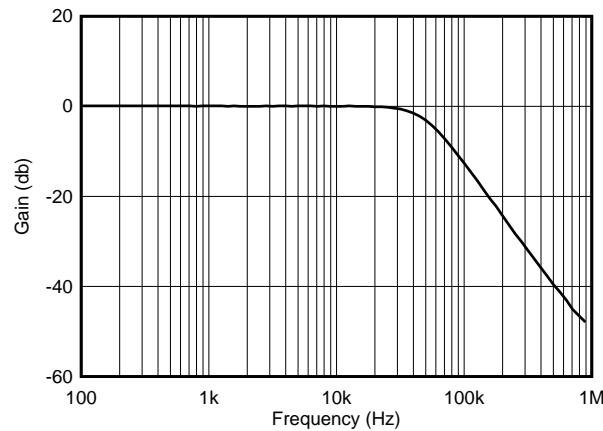
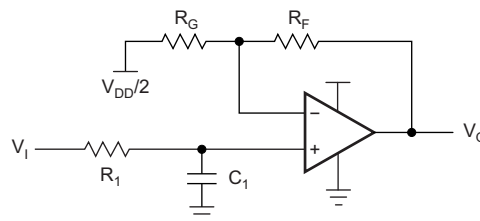

Figure 28. TLV27x Second-Order, 50-kHz, Low-Pass Filter

9.3 System Examples

9.3.1 General Configurations

When receiving low-level signals, limiting the bandwidth of the incoming signals into the system is often required. The simplest way to accomplish this limiting is to place an RC filter at the noninverting terminal of the amplifier (see [Figure 29](#) and [Equation 4](#)).



Copyright © 2016, Texas Instruments Incorporated

Figure 29. Single-Pole Low-Pass Filter

$$\frac{V_O}{V_I} = \left(1 + \frac{R_F}{R_G}\right) \left(\frac{1}{1 + sR_1C_1}\right)$$

$$f_{-3db} = \frac{1}{2\pi R_1 C_1}$$

(4)

System Examples (continued)

If even more attenuation is needed, a multiple pole filter is required. The Sallen-Key filter, shown in [Figure 30](#), can be used for this task. For best results, the amplifier should have a bandwidth that is 8 to 10 times the filter frequency bandwidth; refer to [Equation 5](#). Failure to use an amplifier with this characteristic can result in phase shift of the amplifier.

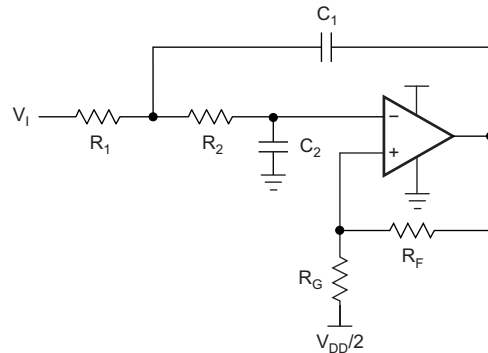

Copyright © 2016, Texas Instruments Incorporated

Figure 30. Two-Pole, Low-Pass, Sallen-Key Filter

$R_1 = R_2 = R$
 $C_1 = C_2 = C$
 $Q = \text{Peaking Factor}$
 (Butterworth $Q = 0.707$)

$$f_{-3\text{db}} = \frac{1}{2\pi RC}$$

$$R_G = \frac{R_F}{\left(2 - \frac{1}{Q}\right)}$$

(5)

10 Power Supply Recommendations

The TLV27x is specified for operation from 2.7 V to 16 V (± 1.35 V to ± 8 V); many specifications apply from -40°C to 125°C . Parameters that can exhibit significant variance with regard to operating voltage or temperature are presented in the [Typical Characteristics](#).

CAUTION

Supply voltages larger than 16.5 V can permanently damage the device; see the [Absolute Maximum Ratings](#).

Place 0.1- μF bypass capacitors close to the power-supply pins to reduce errors coupling in from noisy or high-impedance power supplies. For more detailed information on bypass capacitor placement, see [Layout Guidelines](#).

11 Layout

11.1 Layout Guidelines

To achieve the levels of high performance of the TLV27x, follow proper printed circuit board (PCB) design techniques. A general set of guidelines is given in the following.

- Ground planes—TI highly recommends using a ground plane on the board to provide all components with a low-inductive ground connection. However, in the areas of the amplifier inputs and output, the ground plane can be removed to minimize the stray capacitance.
- Proper power supply decoupling—Use a 6.8- μF tantalum capacitor in parallel with a 0.1- μF ceramic capacitor on each supply terminal. It may be possible to share the tantalum among several amplifiers depending on the application, but a 0.1- μF ceramic capacitor should always be used on the supply terminal of every amplifier. In addition, the 0.1- μF capacitor should be placed as close as possible to the supply terminal. As this distance increases, the inductance in the connecting trace makes the capacitor less effective. The designer should strive for distances of less than 0.1 inches between the device power terminals and the ceramic capacitors.
- Sockets—Sockets can be used but are not recommended. The additional lead inductance in the socket pins often leads to stability problems. Surface-mount packages soldered directly to the printed-circuit board is the best implementation.
- Short trace runs/compact part placements—Optimum high performance is achieved when stray series inductance has been minimized. To realize this, the circuit layout should be made as compact as possible, thereby minimizing the length of all trace runs. Particular attention should be paid to the inverting input of the amplifier. Its length should be kept as short as possible. This helps to minimize stray capacitance at the input of the amplifier.
- Surface-mount passive components—Using surface-mount passive components is recommended for high performance amplifier circuits for several reasons. First, because of the extremely low lead inductance of surface-mount components, the problem with stray series inductance is greatly reduced. Second, the small size of surface-mount components naturally leads to a more compact layout thereby minimizing both stray inductance and capacitance. If leaded components are used, TI recommends keeping the lead lengths as short as possible.

11.2 Layout Example

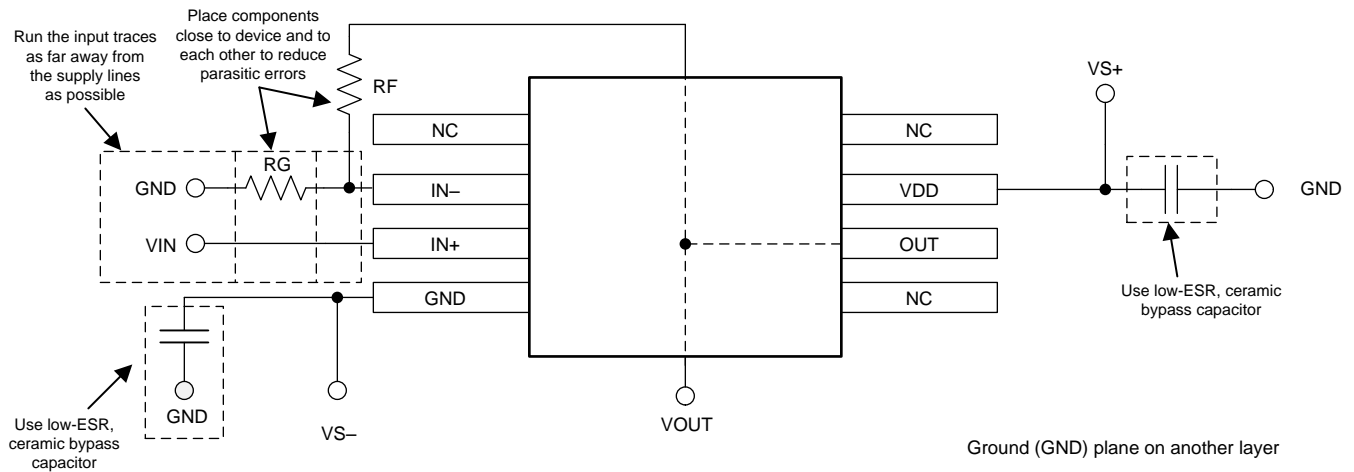
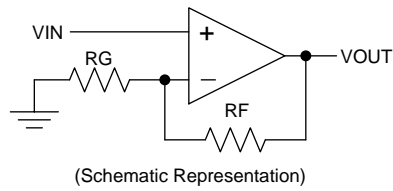

Copyright © 2016, Texas Instruments Incorporated

Figure 31. TLV27x Layout Example

12 Device and Documentation Support

12.1 Documentation Support

12.1.1 Related Documentation

The following documents are relevant to using the TLV27x, and recommended for reference. All are available for download at www.ti.com unless otherwise noted.

- [Compensate Transimpedance Amplifiers Intuitively](#) (SBOA055)
- [Operational amplifier gain stability, Part 3: AC gain-error analysis](#) (SLYT383)
- [Operational amplifier gain stability, Part 2: DC gain-error analysis](#) (SLYT374)
- [Using the infinite-gain, MFB filter topology in fully differential active filters](#) (SLYT343)
- [Op Amp Performance Analysis](#) (SBOA054)
- [Single-Supply Operation of Operational Amplifiers](#) (SBOA059)
- [Tuning in Amplifiers](#) (SBOA067)
- [Shelf-Life Evaluation of Lead-Free Component Finishes](#) (SZZA046)

12.2 Related Links

[Table 2](#) lists quick access links. Categories include technical documents, support and community resources, tools and software, and quick access to sample or buy.

Table 2. Related Links

PARTS	PRODUCT FOLDER	SAMPLE & BUY	TECHNICAL DOCUMENTS	TOOLS & SOFTWARE	SUPPORT & COMMUNITY
TLV271	Click here	Click here	Click here	Click here	Click here
TLV272	Click here	Click here	Click here	Click here	Click here
TLV274	Click here	Click here	Click here	Click here	Click here

12.3 Receiving Notification of Documentation Updates

To receive notification of documentation updates, navigate to the device product folder on ti.com. In the upper right corner, click on *Alert me* to register and receive a weekly digest of any product information that has changed. For change details, review the revision history included in any revised document.

12.4 Community Resource

The following links connect to TI community resources. Linked contents are provided "AS IS" by the respective contributors. They do not constitute TI specifications and do not necessarily reflect TI's views; see TI's [Terms of Use](#).

TI E2E™ Online Community *TI's Engineer-to-Engineer (E2E) Community*. Created to foster collaboration among engineers. At e2e.ti.com, you can ask questions, share knowledge, explore ideas and help solve problems with fellow engineers.

Design Support *TI's Design Support* Quickly find helpful E2E forums along with design support tools and contact information for technical support.

12.5 Trademarks

E2E is a trademark of Texas Instruments.
 WEBENCH is a registered trademark of Texas Instruments.
 All other trademarks are the property of their respective owners.

12.6 Electrostatic Discharge Caution



These devices have limited built-in ESD protection. The leads should be shorted together or the device placed in conductive foam during storage or handling to prevent electrostatic damage to the MOS gates.

12.7 Glossary

[SLYZ022](#) — *TI Glossary*.

This glossary lists and explains terms, acronyms, and definitions.

13 Mechanical, Packaging, and Orderable Information

The following pages include mechanical, packaging, and orderable information. This information is the most current data available for the designated devices. This data is subject to change without notice and revision of this document. For browser-based versions of this data sheet, refer to the left-hand navigation.

PACKAGING INFORMATION

Orderable Device	Status (1)	Package Type	Package Drawing	Pins	Package Qty	Eco Plan (2)	Lead finish/ Ball material (6)	MSL Peak Temp (3)	Op Temp (°C)	Device Marking (4/5)	Samples
TLV271CD	ACTIVE	SOIC	D	8	75	RoHS & Green	NIPDAU	Level-1-260C-UNLIM	0 to 70	T271C	Samples
TLV271CDBVR	ACTIVE	SOT-23	DBV	5	3000	RoHS & Green	NIPDAU	Level-1-260C-UNLIM	0 to 70	VBHC	Samples
TLV271CDBVRG4	ACTIVE	SOT-23	DBV	5	3000	RoHS & Green	NIPDAU	Level-1-260C-UNLIM	0 to 70	VBHC	Samples
TLV271CDBVT	ACTIVE	SOT-23	DBV	5	250	RoHS & Green	NIPDAU	Level-1-260C-UNLIM	0 to 70	VBHC	Samples
TLV271CDBVTG4	ACTIVE	SOT-23	DBV	5	250	RoHS & Green	NIPDAU	Level-1-260C-UNLIM	0 to 70	VBHC	Samples
TLV271CDR	ACTIVE	SOIC	D	8	2500	RoHS & Green	NIPDAU	Level-1-260C-UNLIM	0 to 70	T271C	Samples
TLV271ID	ACTIVE	SOIC	D	8	75	RoHS & Green	NIPDAU	Level-1-260C-UNLIM	-40 to 125	T271I	Samples
TLV271IDBVR	ACTIVE	SOT-23	DBV	5	3000	RoHS & Green	NIPDAU	Level-1-260C-UNLIM	-40 to 125	VBHI	Samples
TLV271IDBVRG4	ACTIVE	SOT-23	DBV	5	3000	RoHS & Green	NIPDAU	Level-1-260C-UNLIM	-40 to 125	VBHI	Samples
TLV271IDBVT	ACTIVE	SOT-23	DBV	5	250	RoHS & Green	NIPDAU	Level-1-260C-UNLIM	-40 to 125	VBHI	Samples
TLV271IDBVTG4	ACTIVE	SOT-23	DBV	5	250	RoHS & Green	NIPDAU	Level-1-260C-UNLIM	-40 to 125	VBHI	Samples
TLV271IDR	ACTIVE	SOIC	D	8	2500	RoHS & Green	NIPDAU	Level-1-260C-UNLIM	-40 to 125	T271I	Samples
TLV271IP	ACTIVE	PDIP	P	8	50	RoHS & Green	NIPDAU	N / A for Pkg Type	-40 to 125	T271I	Samples
TLV272CD	ACTIVE	SOIC	D	8	75	RoHS & Green	NIPDAU	Level-1-260C-UNLIM	0 to 70	T272C	Samples
TLV272CDG4	ACTIVE	SOIC	D	8	75	RoHS & Green	NIPDAU	Level-1-260C-UNLIM	0 to 70	T272C	Samples
TLV272CDGK	ACTIVE	VSSOP	DGK	8	80	RoHS & Green	NIPDAU NIPDAUAG	Level-1-260C-UNLIM	0 to 70	AVF	Samples
TLV272CDGKR	ACTIVE	VSSOP	DGK	8	2500	RoHS & Green	NIPDAU NIPDAUAG	Level-1-260C-UNLIM	0 to 70	AVF	Samples
TLV272CDR	ACTIVE	SOIC	D	8	2500	RoHS & Green	NIPDAU	Level-1-260C-UNLIM	0 to 70	T272C	Samples
TLV272CDRG4	ACTIVE	SOIC	D	8	2500	RoHS & Green	NIPDAU	Level-1-260C-UNLIM	0 to 70	T272C	Samples
TLV272ID	ACTIVE	SOIC	D	8	75	RoHS & Green	NIPDAU	Level-1-260C-UNLIM	-40 to 125	T272I	Samples

Orderable Device	Status (1)	Package Type	Package Drawing	Pins	Package Qty	Eco Plan (2)	Lead finish/ Ball material (6)	MSL Peak Temp (3)	Op Temp (°C)	Device Marking (4/5)	Samples
TLV272IDG4	ACTIVE	SOIC	D	8	75	RoHS & Green	NIPDAU	Level-1-260C-UNLIM	-40 to 125	T272I	Samples
TLV272IDGK	ACTIVE	VSSOP	DGK	8	80	RoHS & Green	NIPDAU NIPDAUAG	Level-1-260C-UNLIM	-40 to 125	AVG	Samples
TLV272IDGKG4	ACTIVE	VSSOP	DGK	8	80	RoHS & Green	NIPDAU	Level-1-260C-UNLIM	-40 to 125	AVG	Samples
TLV272IDGKR	ACTIVE	VSSOP	DGK	8	2500	RoHS & Green	NIPDAU NIPDAUAG	Level-1-260C-UNLIM	-40 to 125	AVG	Samples
TLV272IDGKRG4	ACTIVE	VSSOP	DGK	8	2500	RoHS & Green	NIPDAU	Level-1-260C-UNLIM	-40 to 125	AVG	Samples
TLV272IDR	ACTIVE	SOIC	D	8	2500	RoHS & Green	NIPDAU	Level-1-260C-UNLIM	-40 to 125	T272I	Samples
TLV272IDRG4	ACTIVE	SOIC	D	8	2500	RoHS & Green	NIPDAU	Level-1-260C-UNLIM	-40 to 125	T272I	Samples
TLV272IP	ACTIVE	PDIP	P	8	50	RoHS & Green	NIPDAU	N / A for Pkg Type	-40 to 125	T272I	Samples
TLV274CD	ACTIVE	SOIC	D	14	50	RoHS & Green	NIPDAU	Level-1-260C-UNLIM	0 to 70	TLV274C	Samples
TLV274CDG4	ACTIVE	SOIC	D	14	50	RoHS & Green	NIPDAU	Level-1-260C-UNLIM	0 to 70	TLV274C	Samples
TLV274CDR	ACTIVE	SOIC	D	14	2500	RoHS & Green	NIPDAU	Level-1-260C-UNLIM	0 to 70	TLV274C	Samples
TLV274CPW	ACTIVE	TSSOP	PW	14	90	RoHS & Green	NIPDAU	Level-1-260C-UNLIM	0 to 70	TLV274C	Samples
TLV274CPWR	ACTIVE	TSSOP	PW	14	2000	RoHS & Green	NIPDAU	Level-1-260C-UNLIM	0 to 70	TLV274C	Samples
TLV274CPWRG4	ACTIVE	TSSOP	PW	14	2000	RoHS & Green	NIPDAU	Level-1-260C-UNLIM	0 to 70	TLV274C	Samples
TLV274ID	ACTIVE	SOIC	D	14	50	RoHS & Green	NIPDAU	Level-1-260C-UNLIM	-40 to 125	TLV274I	Samples
TLV274IDG4	ACTIVE	SOIC	D	14	50	RoHS & Green	NIPDAU	Level-1-260C-UNLIM	-40 to 125	TLV274I	Samples
TLV274IDR	ACTIVE	SOIC	D	14	2500	RoHS & Green	NIPDAU	Level-1-260C-UNLIM	-40 to 125	TLV274I	Samples
TLV274IDRG4	ACTIVE	SOIC	D	14	2500	RoHS & Green	NIPDAU	Level-1-260C-UNLIM	-40 to 125	TLV274I	Samples
TLV274IN	ACTIVE	PDIP	N	14	25	RoHS & Green	NIPDAU	N / A for Pkg Type	-40 to 125	TLV274I	Samples
TLV274IPW	ACTIVE	TSSOP	PW	14	90	RoHS & Green	NIPDAU	Level-1-260C-UNLIM	-40 to 125	TLV274I	Samples
TLV274IPWG4	ACTIVE	TSSOP	PW	14	90	RoHS & Green	NIPDAU	Level-1-260C-UNLIM	-40 to 125	TLV274I	Samples

Orderable Device	Status (1)	Package Type	Package Drawing	Pins	Package Qty	Eco Plan (2)	Lead finish/ Ball material (6)	MSL Peak Temp (3)	Op Temp (°C)	Device Marking (4/5)	Samples
TLV274IPWR	ACTIVE	TSSOP	PW	14	2000	RoHS & Green	NIPDAU	Level-1-260C-UNLIM	-40 to 125	TLV274I	Samples
TLV274IPWRG4	ACTIVE	TSSOP	PW	14	2000	RoHS & Green	NIPDAU	Level-1-260C-UNLIM	-40 to 125	TLV274I	Samples

(1) The marketing status values are defined as follows:

ACTIVE: Product device recommended for new designs.

LIFEBUY: TI has announced that the device will be discontinued, and a lifetime-buy period is in effect.

NRND: Not recommended for new designs. Device is in production to support existing customers, but TI does not recommend using this part in a new design.

PREVIEW: Device has been announced but is not in production. Samples may or may not be available.

OBSOLETE: TI has discontinued the production of the device.

(2) **RoHS:** TI defines "RoHS" to mean semiconductor products that are compliant with the current EU RoHS requirements for all 10 RoHS substances, including the requirement that RoHS substance do not exceed 0.1% by weight in homogeneous materials. Where designed to be soldered at high temperatures, "RoHS" products are suitable for use in specified lead-free processes. TI may reference these types of products as "Pb-Free".

RoHS Exempt: TI defines "RoHS Exempt" to mean products that contain lead but are compliant with EU RoHS pursuant to a specific EU RoHS exemption.

Green: TI defines "Green" to mean the content of Chlorine (Cl) and Bromine (Br) based flame retardants meet JS709B low halogen requirements of <=1000ppm threshold. Antimony trioxide based flame retardants must also meet the <=1000ppm threshold requirement.

(3) MSL, Peak Temp. - The Moisture Sensitivity Level rating according to the JEDEC industry standard classifications, and peak solder temperature.

(4) There may be additional marking, which relates to the logo, the lot trace code information, or the environmental category on the device.

(5) Multiple Device Markings will be inside parentheses. Only one Device Marking contained in parentheses and separated by a "~" will appear on a device. If a line is indented then it is a continuation of the previous line and the two combined represent the entire Device Marking for that device.

(6) Lead finish/Ball material - Orderable Devices may have multiple material finish options. Finish options are separated by a vertical ruled line. Lead finish/Ball material values may wrap to two lines if the finish value exceeds the maximum column width.

Important Information and Disclaimer:The information provided on this page represents TI's knowledge and belief as of the date that it is provided. TI bases its knowledge and belief on information provided by third parties, and makes no representation or warranty as to the accuracy of such information. Efforts are underway to better integrate information from third parties. TI has taken and continues to take reasonable steps to provide representative and accurate information but may not have conducted destructive testing or chemical analysis on incoming materials and chemicals. TI and TI suppliers consider certain information to be proprietary, and thus CAS numbers and other limited information may not be available for release.

In no event shall TI's liability arising out of such information exceed the total purchase price of the TI part(s) at issue in this document sold by TI to Customer on an annual basis.

OTHER QUALIFIED VERSIONS OF TLV271, TLV272, TLV274 :

- Automotive : [TLV271-Q1](#), [TLV272-Q1](#), [TLV274-Q1](#)

NOTE: Qualified Version Definitions:

- Automotive - Q100 devices qualified for high-reliability automotive applications targeting zero defects

TAPE AND REEL INFORMATION

QUADRANT ASSIGNMENTS FOR PIN 1 ORIENTATION IN TAPE

*All dimensions are nominal

Device	Package Type	Package Drawing	Pins	SPQ	Reel Diameter (mm)	Reel Width W1 (mm)	A0 (mm)	B0 (mm)	K0 (mm)	P1 (mm)	W (mm)	Pin1 Quadrant
TLV271CDBVR	SOT-23	DBV	5	3000	178.0	9.0	3.23	3.17	1.37	4.0	8.0	Q3
TLV271CDBVT	SOT-23	DBV	5	250	178.0	9.0	3.3	3.2	1.4	4.0	8.0	Q3
TLV271CDR	SOIC	D	8	2500	330.0	12.4	6.4	5.2	2.1	8.0	12.0	Q1
TLV271IDBVR	SOT-23	DBV	5	3000	178.0	9.0	3.3	3.2	1.4	4.0	8.0	Q3
TLV271IDBVT	SOT-23	DBV	5	250	178.0	9.0	3.3	3.2	1.4	4.0	8.0	Q3
TLV271IDR	SOIC	D	8	2500	330.0	12.4	6.4	5.2	2.1	8.0	12.0	Q1
TLV272CDGKR	VSSOP	DGK	8	2500	330.0	12.4	5.3	3.4	1.4	8.0	12.0	Q1
TLV272CDGKR	VSSOP	DGK	8	2500	330.0	12.4	5.3	3.4	1.4	8.0	12.0	Q1
TLV272CDR	SOIC	D	8	2500	330.0	12.4	6.4	5.2	2.1	8.0	12.0	Q1
TLV272IDGKR	VSSOP	DGK	8	2500	330.0	12.4	5.3	3.4	1.4	8.0	12.0	Q1
TLV272IDGKR	VSSOP	DGK	8	2500	330.0	12.4	5.3	3.4	1.4	8.0	12.0	Q1
TLV272IDR	SOIC	D	8	2500	330.0	12.4	6.4	5.2	2.1	8.0	12.0	Q1
TLV274CDR	SOIC	D	14	2500	330.0	16.4	6.5	9.0	2.1	8.0	16.0	Q1
TLV274CPWR	TSSOP	PW	14	2000	330.0	12.4	6.9	5.6	1.6	8.0	12.0	Q1
TLV274IDR	SOIC	D	14	2500	330.0	16.4	6.5	9.0	2.1	8.0	16.0	Q1
TLV274IPWR	TSSOP	PW	14	2000	330.0	12.4	6.9	5.6	1.6	8.0	12.0	Q1

TAPE AND REEL BOX DIMENSIONS

*All dimensions are nominal

Device	Package Type	Package Drawing	Pins	SPQ	Length (mm)	Width (mm)	Height (mm)
TLV271CDBVR	SOT-23	DBV	5	3000	180.0	180.0	18.0
TLV271CDBVT	SOT-23	DBV	5	250	180.0	180.0	18.0
TLV271CDR	SOIC	D	8	2500	340.5	336.1	25.0
TLV271IDBVR	SOT-23	DBV	5	3000	180.0	180.0	18.0
TLV271IDBVT	SOT-23	DBV	5	250	180.0	180.0	18.0
TLV271IDR	SOIC	D	8	2500	340.5	336.1	25.0
TLV272CDGKR	VSSOP	DGK	8	2500	364.0	364.0	27.0
TLV272CDGKR	VSSOP	DGK	8	2500	358.0	335.0	35.0
TLV272CDR	SOIC	D	8	2500	340.5	336.1	25.0
TLV272IDGKR	VSSOP	DGK	8	2500	364.0	364.0	27.0
TLV272IDGKR	VSSOP	DGK	8	2500	358.0	335.0	35.0
TLV272IDR	SOIC	D	8	2500	340.5	336.1	25.0
TLV274CDR	SOIC	D	14	2500	340.5	336.1	32.0
TLV274CPWR	TSSOP	PW	14	2000	853.0	449.0	35.0
TLV274IDR	SOIC	D	14	2500	340.5	336.1	32.0
TLV274IPWR	TSSOP	PW	14	2000	853.0	449.0	35.0



DBV0005A

PACKAGE OUTLINE

SOT-23 - 1.45 mm max height

SMALL OUTLINE TRANSISTOR

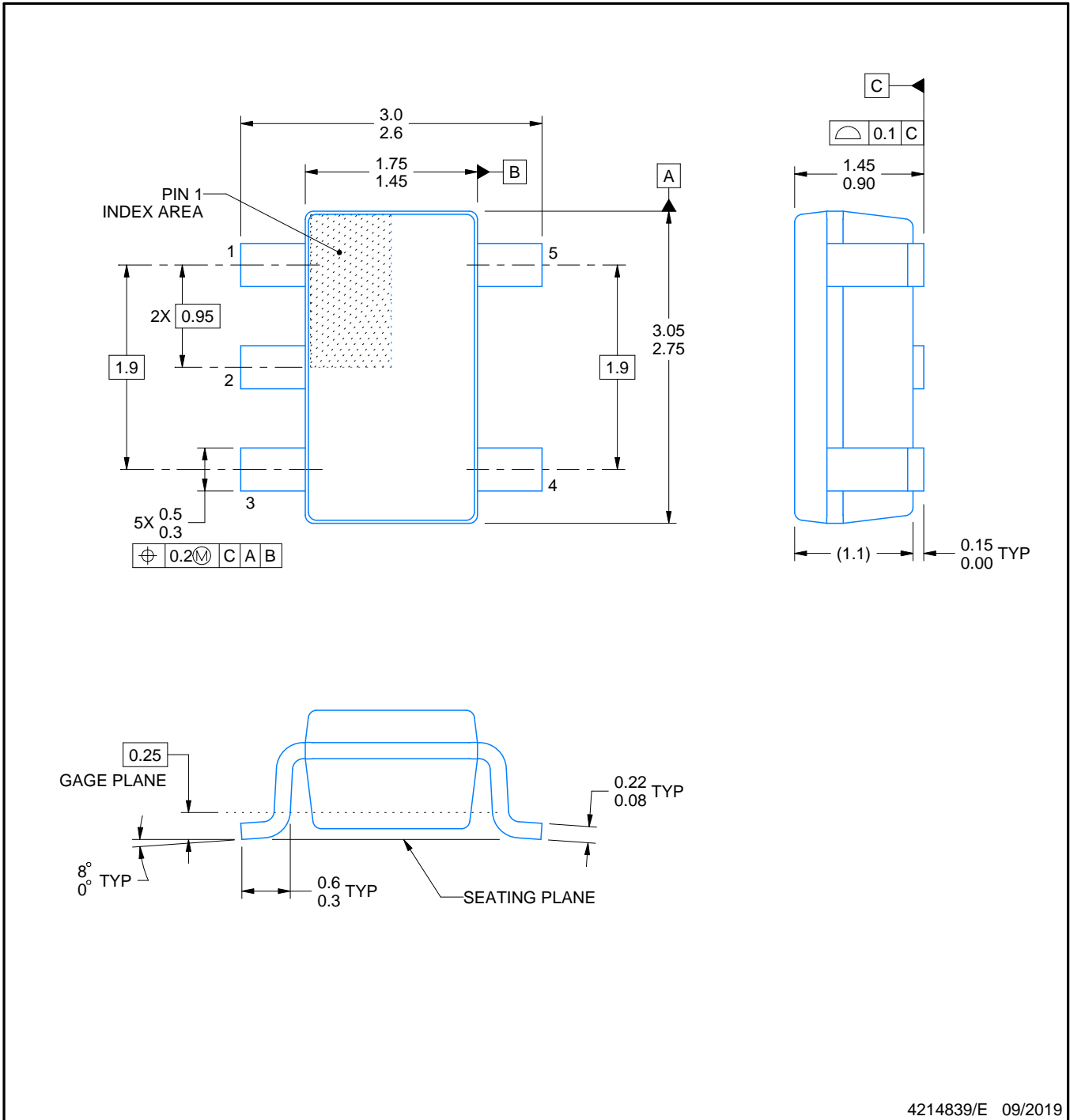

4214839/E 09/2019

NOTES:

1. All linear dimensions are in millimeters. Any dimensions in parenthesis are for reference only. Dimensioning and tolerancing per ASME Y14.5M.
2. This drawing is subject to change without notice.
3. Reference JEDEC MO-178.
4. Body dimensions do not include mold flash, protrusions, or gate burrs. Mold flash, protrusions, or gate burrs shall not exceed 0.15 mm per side.

EXAMPLE BOARD LAYOUT

DBV0005A

SOT-23 - 1.45 mm max height

SMALL OUTLINE TRANSISTOR



LAND PATTERN EXAMPLE
EXPOSED METAL SHOWN
SCALE:15X

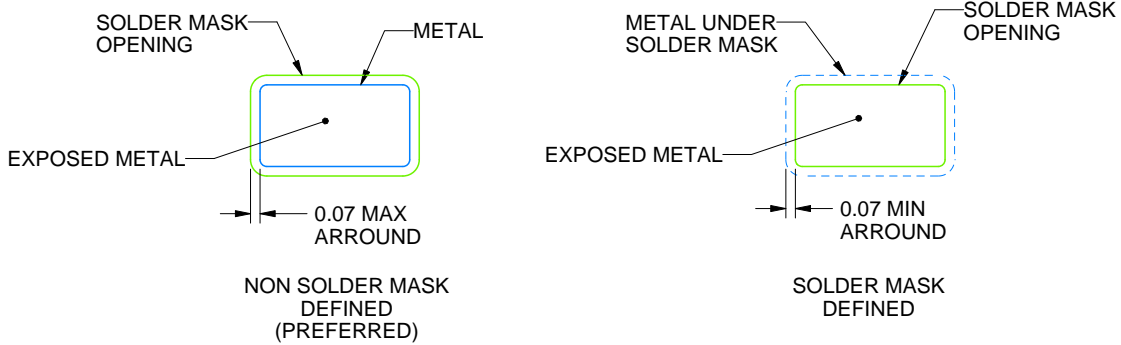

SOLDER MASK DETAILS

4214839/E 09/2019

NOTES: (continued)

- 5. Publication IPC-7351 may have alternate designs.
- 6. Solder mask tolerances between and around signal pads can vary based on board fabrication site.

EXAMPLE STENCIL DESIGN

DBV0005A

SOT-23 - 1.45 mm max height

SMALL OUTLINE TRANSISTOR



SOLDER PASTE EXAMPLE
BASED ON 0.125 mm THICK STENCIL
SCALE:15X

4214839/E 09/2019

NOTES: (continued)

7. Laser cutting apertures with trapezoidal walls and rounded corners may offer better paste release. IPC-7525 may have alternate design recommendations.
8. Board assembly site may have different recommendations for stencil design.

DBV0005A



PACKAGE OUTLINE

SOT-23 - 1.45 mm max height

SMALL OUTLINE TRANSISTOR

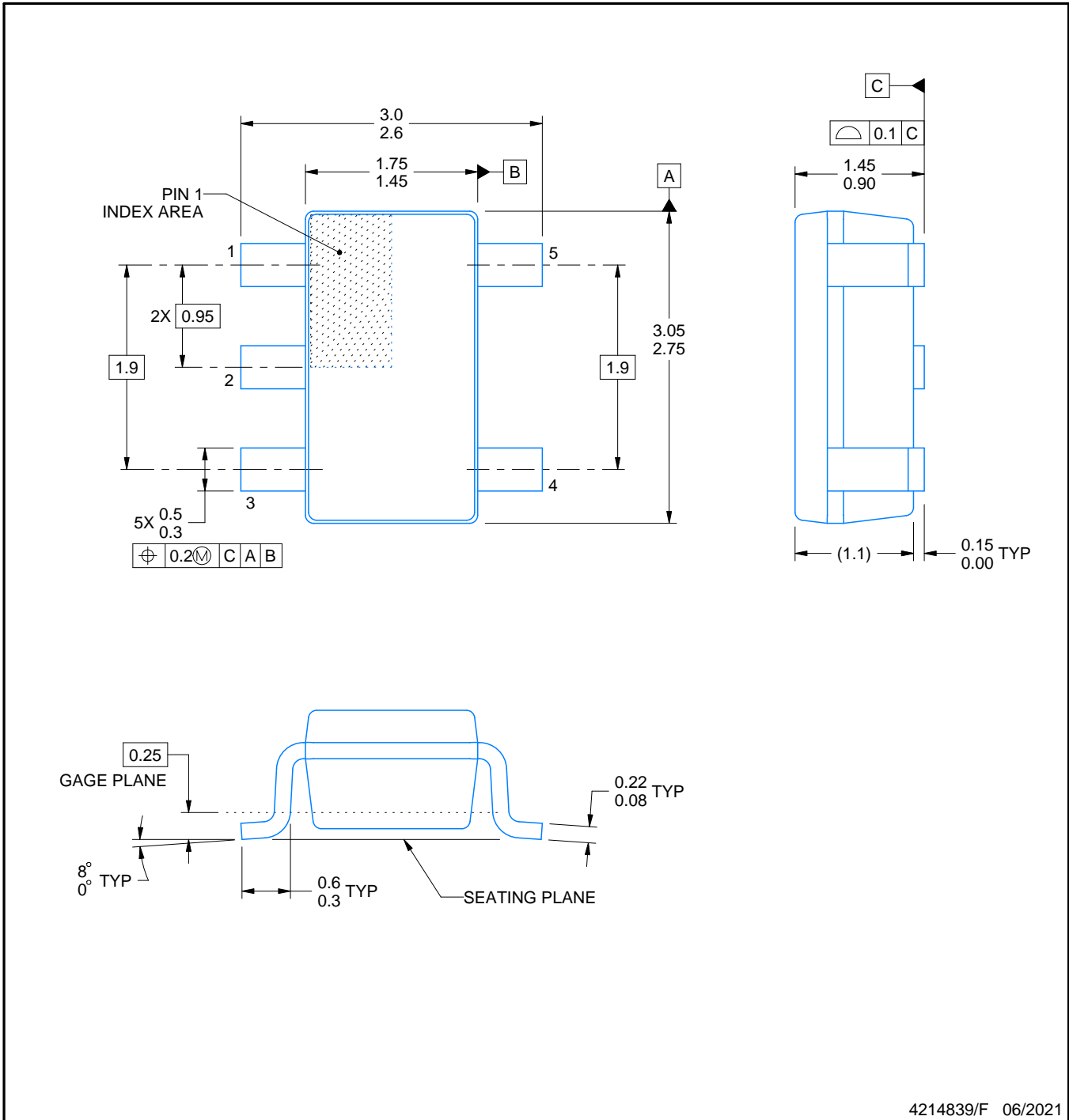

4214839/F 06/2021

NOTES:

1. All linear dimensions are in millimeters. Any dimensions in parenthesis are for reference only. Dimensioning and tolerancing per ASME Y14.5M.
2. This drawing is subject to change without notice.
3. Reference JEDEC MO-178.
4. Body dimensions do not include mold flash, protrusions, or gate burrs. Mold flash, protrusions, or gate burrs shall not exceed 0.25 mm per side.

EXAMPLE BOARD LAYOUT

DBV0005A

SOT-23 - 1.45 mm max height

SMALL OUTLINE TRANSISTOR



LAND PATTERN EXAMPLE
EXPOSED METAL SHOWN
SCALE:15X



SOLDER MASK DETAILS

4214839/F 06/2021

NOTES: (continued)

- 5. Publication IPC-7351 may have alternate designs.
- 6. Solder mask tolerances between and around signal pads can vary based on board fabrication site.

EXAMPLE STENCIL DESIGN

DBV0005A

SOT-23 - 1.45 mm max height

SMALL OUTLINE TRANSISTOR



SOLDER PASTE EXAMPLE
BASED ON 0.125 mm THICK STENCIL
SCALE:15X

4214839/F 06/2021

NOTES: (continued)

7. Laser cutting apertures with trapezoidal walls and rounded corners may offer better paste release. IPC-7525 may have alternate design recommendations.
8. Board assembly site may have different recommendations for stencil design.

D (R-PDSO-G14)

PLASTIC SMALL OUTLINE



- NOTES:
- A. All linear dimensions are in inches (millimeters).
 - B. This drawing is subject to change without notice.
 -  Body length does not include mold flash, protrusions, or gate burrs. Mold flash, protrusions, or gate burrs shall not exceed 0.006 (0,15) each side.
 -  Body width does not include interlead flash. Interlead flash shall not exceed 0.017 (0,43) each side.
 - E. Reference JEDEC MS-012 variation AB.

D (R-PDSO-G14)

PLASTIC SMALL OUTLINE



4211283-3/E 08/12

- NOTES:
- All linear dimensions are in millimeters.
 - This drawing is subject to change without notice.
 - Publication IPC-7351 is recommended for alternate designs.
 - Laser cutting apertures with trapezoidal walls and also rounding corners will offer better paste release. Customers should contact their board assembly site for stencil design recommendations. Refer to IPC-7525 for other stencil recommendations.
 - Customers should contact their board fabrication site for solder mask tolerances between and around signal pads.

PW (R-PDSO-G14)

PLASTIC SMALL OUTLINE



- NOTES:
- A. All linear dimensions are in millimeters. Dimensioning and tolerancing per ASME Y14.5M-1994.
 - B. This drawing is subject to change without notice.
 - C. Body length does not include mold flash, protrusions, or gate burrs. Mold flash, protrusions, or gate burrs shall not exceed 0,15 each side.
 - D. Body width does not include interlead flash. Interlead flash shall not exceed 0,25 each side.
 - E. Falls within JEDEC MO-153



D0008A

PACKAGE OUTLINE

SOIC - 1.75 mm max height

SMALL OUTLINE INTEGRATED CIRCUIT



NOTES:

1. Linear dimensions are in inches [millimeters]. Dimensions in parenthesis are for reference only. Controlling dimensions are in inches. Dimensioning and tolerancing per ASME Y14.5M.
2. This drawing is subject to change without notice.
3. This dimension does not include mold flash, protrusions, or gate burrs. Mold flash, protrusions, or gate burrs shall not exceed $.006$ [0.15] per side.
4. This dimension does not include interlead flash.
5. Reference JEDEC registration MS-012, variation AA.

EXAMPLE BOARD LAYOUT

D0008A

SOIC - 1.75 mm max height

SMALL OUTLINE INTEGRATED CIRCUIT



LAND PATTERN EXAMPLE
 EXPOSED METAL SHOWN
 SCALE:8X



SOLDER MASK DETAILS

4214825/C 02/2019

NOTES: (continued)

- 6. Publication IPC-7351 may have alternate designs.
- 7. Solder mask tolerances between and around signal pads can vary based on board fabrication site.

EXAMPLE STENCIL DESIGN

D0008A

SOIC - 1.75 mm max height

SMALL OUTLINE INTEGRATED CIRCUIT



SOLDER PASTE EXAMPLE
BASED ON .005 INCH [0.125 MM] THICK STENCIL
SCALE:8X

4214825/C 02/2019

NOTES: (continued)

8. Laser cutting apertures with trapezoidal walls and rounded corners may offer better paste release. IPC-7525 may have alternate design recommendations.
9. Board assembly site may have different recommendations for stencil design.

P (R-PDIP-T8)

PLASTIC DUAL-IN-LINE PACKAGE



- NOTES:
- A. All linear dimensions are in inches (millimeters).
 - B. This drawing is subject to change without notice.
 - C. Falls within JEDEC MS-001 variation BA.

N (R-PDIP-T**)

PLASTIC DUAL-IN-LINE PACKAGE

16 PINS SHOWN



- NOTES:
- A. All linear dimensions are in inches (millimeters).
 - B. This drawing is subject to change without notice.
 - Falls within JEDEC MS-001, except 18 and 20 pin minimum body length (Dim A).
 - The 20 pin end lead shoulder width is a vendor option, either half or full width.

DGK (S-PDSO-G8)

PLASTIC SMALL-OUTLINE PACKAGE



- NOTES:
- A. All linear dimensions are in millimeters.
 - B. This drawing is subject to change without notice.
 - C. Body length does not include mold flash, protrusions, or gate burrs. Mold flash, protrusions, or gate burrs shall not exceed 0.15 per end.
 - D. Body width does not include interlead flash. Interlead flash shall not exceed 0.50 per side.
 - E. Falls within JEDEC MO-187 variation AA, except interlead flash.



- NOTES:
- A. All linear dimensions are in millimeters.
 - B. This drawing is subject to change without notice.
 - C. Publication IPC-7351 is recommended for alternate designs.
 - D. Laser cutting apertures with trapezoidal walls and also rounding corners will offer better paste release. Customers should contact their board assembly site for stencil design recommendations. Refer to IPC-7525 for other stencil recommendations.
 - E. Customers should contact their board fabrication site for solder mask tolerances between and around signal pads.

IMPORTANT NOTICE AND DISCLAIMER

TI PROVIDES TECHNICAL AND RELIABILITY DATA (INCLUDING DATASHEETS), DESIGN RESOURCES (INCLUDING REFERENCE DESIGNS), APPLICATION OR OTHER DESIGN ADVICE, WEB TOOLS, SAFETY INFORMATION, AND OTHER RESOURCES "AS IS" AND WITH ALL FAULTS, AND DISCLAIMS ALL WARRANTIES, EXPRESS AND IMPLIED, INCLUDING WITHOUT LIMITATION ANY IMPLIED WARRANTIES OF MERCHANTABILITY, FITNESS FOR A PARTICULAR PURPOSE OR NON-INFRINGEMENT OF THIRD PARTY INTELLECTUAL PROPERTY RIGHTS.

These resources are intended for skilled developers designing with TI products. You are solely responsible for (1) selecting the appropriate TI products for your application, (2) designing, validating and testing your application, and (3) ensuring your application meets applicable standards, and any other safety, security, or other requirements. These resources are subject to change without notice. TI grants you permission to use these resources only for development of an application that uses the TI products described in the resource. Other reproduction and display of these resources is prohibited. No license is granted to any other TI intellectual property right or to any third party intellectual property right. TI disclaims responsibility for, and you will fully indemnify TI and its representatives against, any claims, damages, costs, losses, and liabilities arising out of your use of these resources.

TI's products are provided subject to TI's Terms of Sale (<https://www.ti.com/legal/termsofsale.html>) or other applicable terms available either on [ti.com](https://www.ti.com) or provided in conjunction with such TI products. TI's provision of these resources does not expand or otherwise alter TI's applicable warranties or warranty disclaimers for TI products.

Mailing Address: Texas Instruments, Post Office Box 655303, Dallas, Texas 75265
Copyright © 2021, Texas Instruments Incorporated