

FEATURES

- Cermet resistive element.
- Plastic material according to UL94V-0.
- Alumina substrate.
- IP54 protection according to IEC 60529.
- Also upon request:
 - Wiper positioned at initial, 50% or fully clockwise.
 - Long life model for low cost control pot. applications.
 - Supplied in magazines for automatic insertion.
 - Low torque option.
 - Available as SPDT switch.
 - Laser trimming for tighter tolerances.
 - Mechanical detents.
 - Special tapers.

MECHANICAL SPECIFICATIONS

- Mechanical rotation angle: $265^\circ \pm 5^\circ$
- Electrical rotation angle: $240^\circ \pm 20^\circ$
- Torque: 0.5 to 2.5 Ncm. (0.7 to 3.4 in-oz)
- Stop torque: > 10 Ncm. (>14 in-oz)
- Life*: Up to 10K cycles

ELECTRICAL SPECIFICATIONS

- Range of values*
 $100\Omega \leq R_n \leq 5\text{ M}$ (Decad. 1.0 - 2.0 - 2.2 - 2.5 - 4.7 - 5.0)
- Tolerance*: $100\Omega \leq R_n \leq 1\text{M}\Omega$ ----- $\pm 20\%$
 $1\text{M}\Omega < R_n \leq 5\text{M}\Omega$ ----- $\pm 30\%$
- Max. Voltage: 250 VDC (lin) 125 VDC (no lin)
- Nominal Power 70°C (158°F) (see power rating curve)
0.50 W (lin) 0.25 W (no lin)
- Taper* (Log. & Alog. only $R_n \geq 1\text{K}$) Lin ; Log; Alog.
- Residual resistance*: $\leq 0.5\%$ R_n (5 Ω min.)
- Equivalent Noise Resistance: $\leq 3\%$ R_n (3 Ω min.)
- Operating temperature**: $-40^\circ\text{C} + 90^\circ\text{C}$ ($-40^\circ\text{F} + 194^\circ\text{F}$)

* Others check availability.

** Up to +120°C depending on application. Check availability.

HOW TO ORDER

Series		Code	Mounting Method	Taper	Value	Tolerance	Long Life	Shaft Thum.	Wiper position	Magazine	Shaft/rotor colour	Detents	Torque
PTC15	L	H01	-	223	A	2020							
Rotors		H01	H2.5	A = Lin.	101 = 100 Ω	0505 = $\pm 5\%$	E = Long life	01 - Fig. 1	PM = 50%	T	RO = Red	PAI	-- = Standard
		H05	H5	B = Log.	223 = 22 K	0707 = $\pm 7\%$	(See note 5)	28 - Fig. 28	PF = Final	(See note 8)	NE = Black	PAM	L = Low Torque
		H15	HA5	C = Alog.	504 = 500 K	1010 = $\pm 10\%$		(See note 9)			VE = Green	P11	(See note 7)
		H06	B		505 = 5 M	3030 = $\pm 30\%$					AM = Yellow	P1F	
		H10	H5P		000 = C M	(See note 4)					AZ = Blue	P02	
		V02	V12.5								MA = Brown	...	
		V12	VA								GR = Grey	P38	
		V15	V15								NA = Orange		
		V17	V17.5										
		V18	D										
		V21	V12.5P										
		V22	VAP										
		V23	V15P										
		V25	V17.5P										

NOTES

- "Z" adjustment only available on "H" versions. Standard colour for the "T" rotor: Orange
- Terminals styles: "P" are crimped terminals. V=Vertical adjust; H=Horizontal Adjust
- Value Example: Code: $\begin{matrix} 10 & 1 & 100\Omega \\ \swarrow & \searrow & \\ \text{Numb of zeros} & & \\ \text{First two digits of the value.} & & \end{matrix}$ 000 = CM: SPDT switch 45°
- Non standard tolerance, check availability. Example: +7% -5% Code: $\begin{matrix} 07 & 05 \\ \swarrow & \searrow \\ \text{negative tolerance} & & \\ \text{positive tolerance} & & \end{matrix}$
- Life
 - Standard: 1K cycles
 - Long life: 10K cycles
- Colour shaft/rotor:
 - Potentiometer without shaft: only rotor
 - Potentiometer with shaft: only shaft
- Low Torque: $\leq 1.5\text{Ncm}$. No detent option available for low torque models
- Magazines (35 pcs/mag): available for VA (12.5), V (12.5), V (12.5P), V (15), V15 (P) and H models. For more information please contact your nearest Piher supplier.
- If you wish to use your own custom plastic shaft/knob/actuator please contact Piher for advice about compatible materials.

HOW TO ORDER CUSTOM DRAWING

PTC-15 LH 01 + DRAWING NUMBER (Max. 16 digits)

This way of ordering should be used for options which are not included in the "How to order" standard and optional extras.

STANDARD OPTIONS

Detents	None
Rotor colour	Natural
Shaft colour	Natural
Wiper position	Initial
Torque	Standard
Life	1000 cycles

ROTORS

Wipers positioned at initial (without shaft)

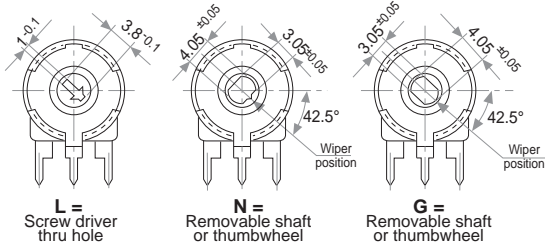

Wipers positioned at 50% (without shaft)

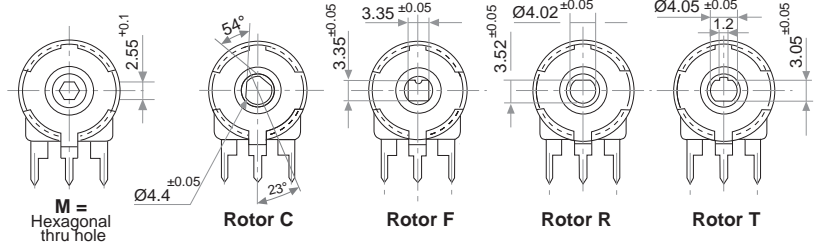

With shaft

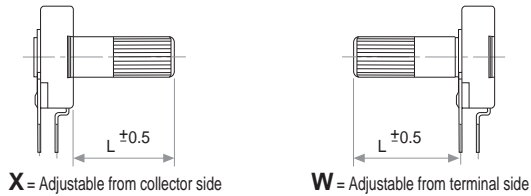

With thumbwheel



VERTICAL MOUNTING – HORIZONTAL ADJUSTMENT

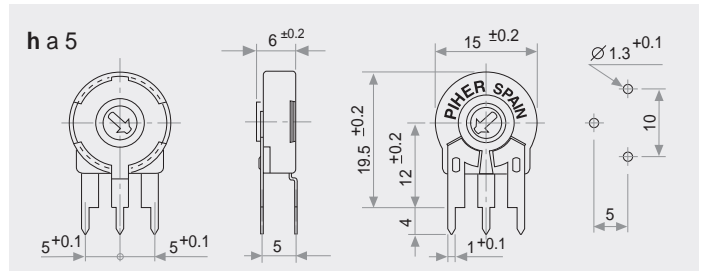
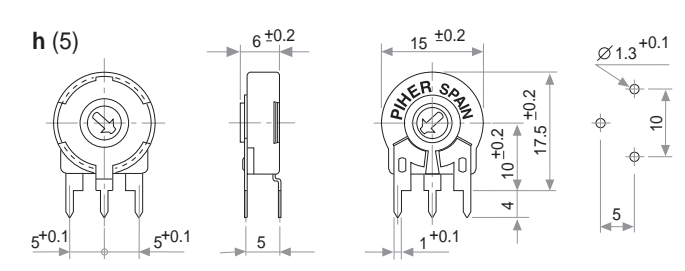
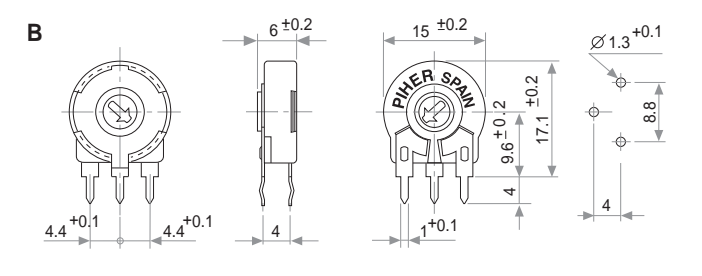
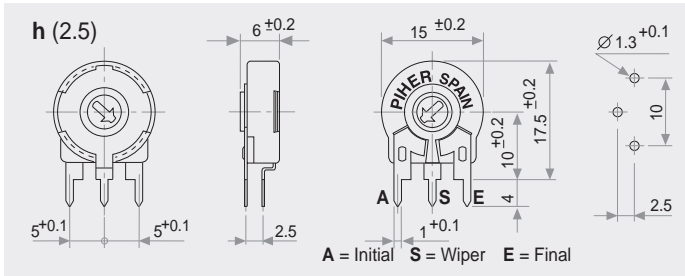

HORIZONTAL MOUNTING – VERTICAL ADJUSTMENT

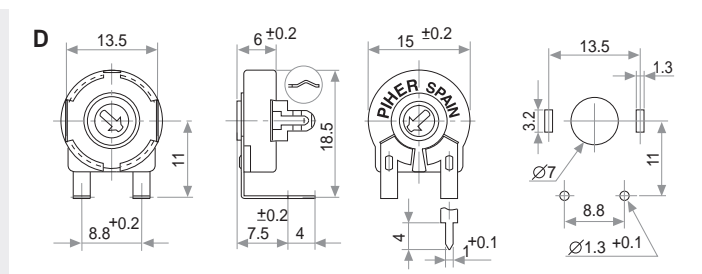
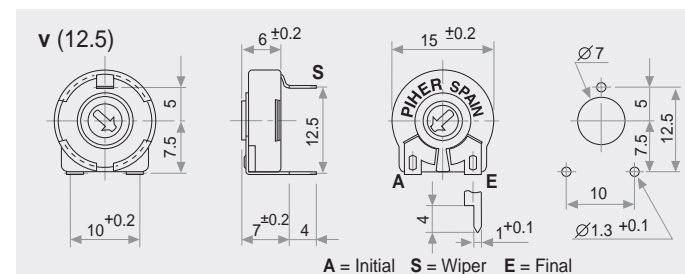

HORIZONTAL MOUNTING – VERTICAL ADJUSTMENT

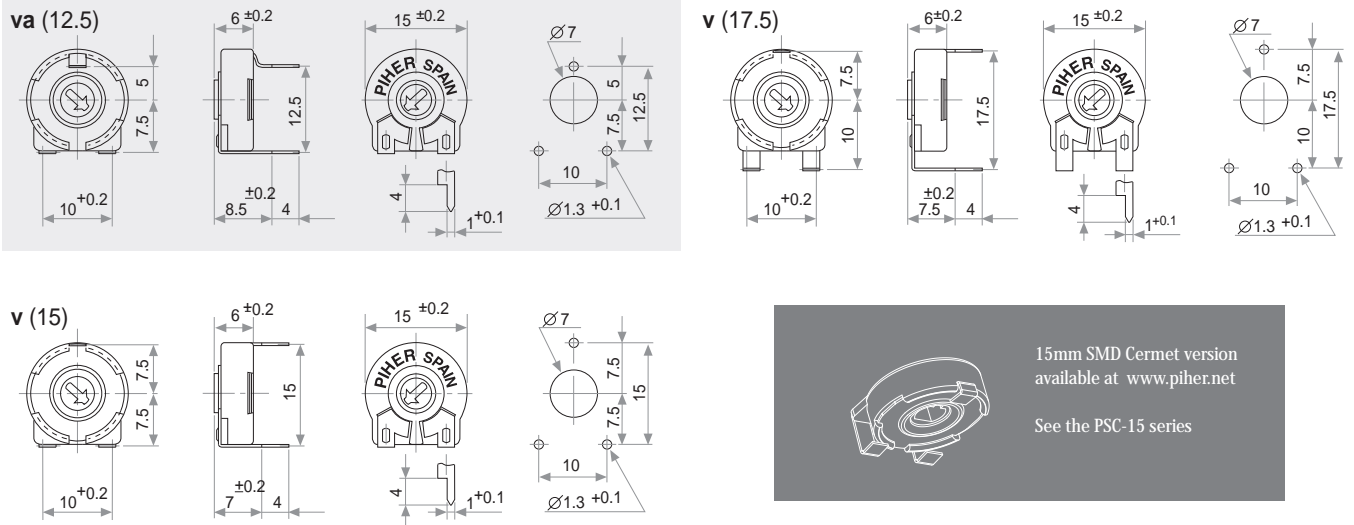

DETENT DETAILS

22 detents
example

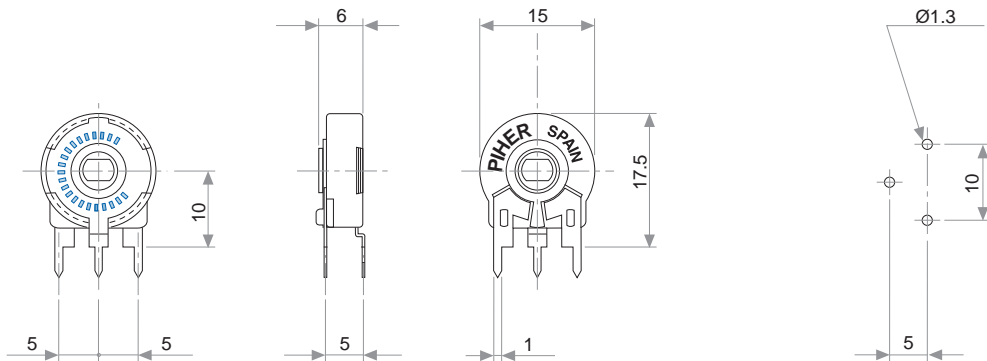

CRIMPED TERMINALS (DETAIL)

POWER RATING CURVE

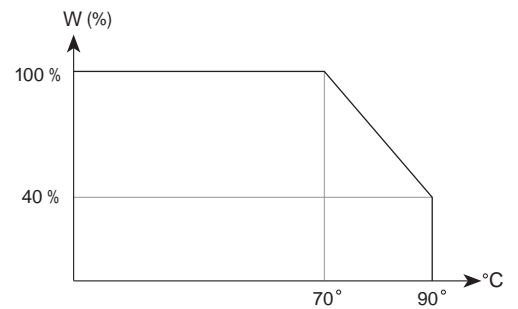
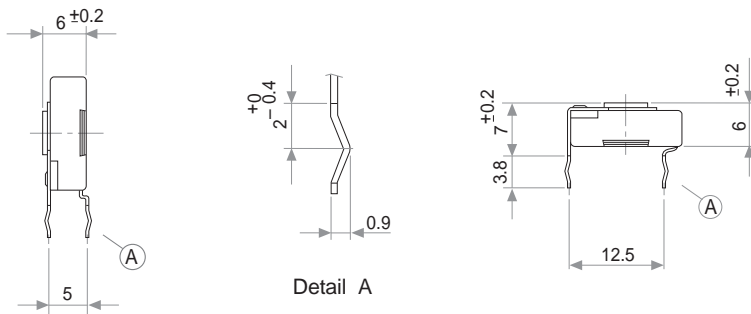

TAPER

POSITIONING

Please note relative terminal positions when ordering non linear tapers.

A = Linear
B = Log.
C = Alog.

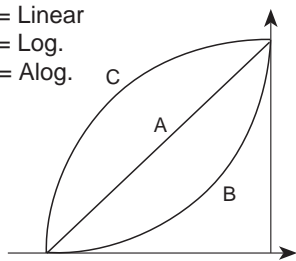

Standard

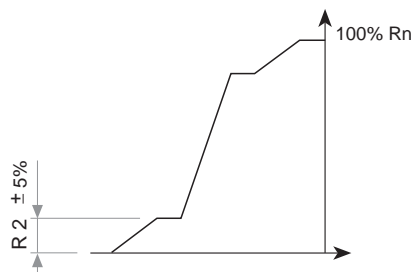

Special curve example

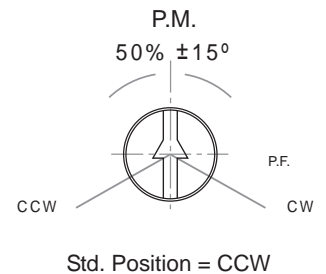

Std. Position = CCW

STANDARD SWITCH VERSION

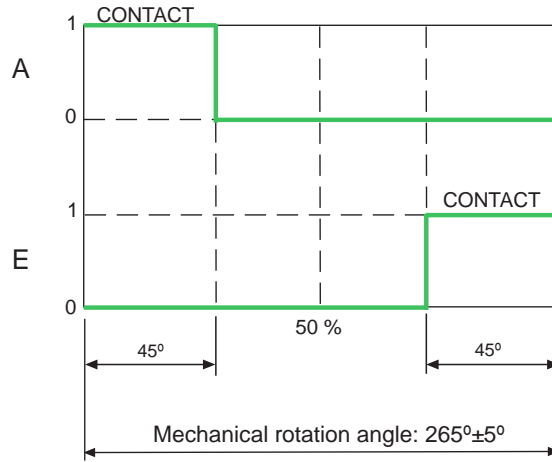
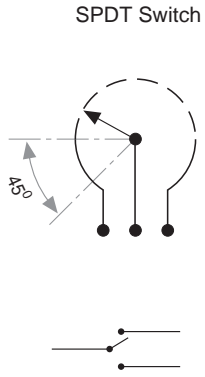

SW Standard specs.

Power Rating:
24V / 15mA

ON position resistance:
 $\leq 5 \Omega$

Insulation Resistance:
 $\geq 30 M\Omega$

Please contact Piher
for ordering information.

TESTS

TYPICAL VARIATIONS

ELECTRICAL LIFE	1.000 h. @ 70°C; 0.5 W	$\pm 5 \%$
MECHANICAL LIFE (CYCLES)	1000 @ 10 CPM ... 15 CPM	$\pm 2 \%$ (Rn < 1 M Ω)
TEMPERATURE COEFFICIENT	-40° C; +90° C	± 100 ppm (Rn < 100 K)
THERMAL CYCLING	16 h. @ 90° C; 2h. @ -40° C	$\pm 2.5 \%$
DAMP HEAT	500 h. @ 40° C @ 95% HR	$\pm 5 \%$
VIBRATION (for each plane X,Y,Z)	2 h. @ 10 Hz. ... 55 Hz.	$\pm 2 \%$

NOTE: Out of range values may not comply these results.

SHAFTS

Hollow model shafts

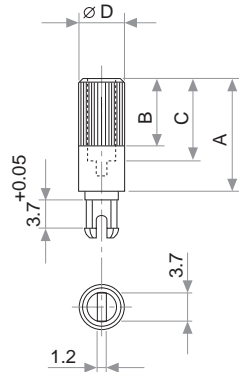

FIG.	A	B	C	D	Ref.
1	12	9	8	6	5272
2	19	9	15	6	5214
5	9.5	6.5	5.5	6	5208
9	35	9	31	6	5216
10	37.8	9	33.8	6	5218
11	35	25	31	6	5209
13	7.8	4.8	3.8	6	5265

A = Length (FRS)
B = Knurling length
C = Hollow depth
D = Shaft diameter
FRS = From rotor surface

Solid model shafts

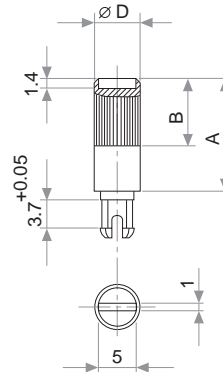
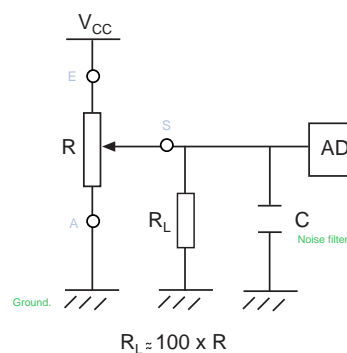

FIG.	A	B	D	Ref.
6	15	9	6	5219
7	16.8	9	6	5220
8	25.3	9	6	5207
12	46	5	6	5227

Slot (1 x 1.4) perpendicular to wiper position. Fig. 12 slot is on line with wiper position.

RECOMMENDED CONNECTIONS

Piher potentiometer's recommended connection circuit for a position sensor or control application. (voltage divider circuit electronic design).



SHAFTS

By default shafts, knobs & thumbwheels are delivered unassembled.
 Mounted shafts, knobs & thumbwheels are delivered at random position. Positioning available check availability.
 If you wish to use your own plastic shaft/knob/actuator please contact Piher for advice about compatible materials.

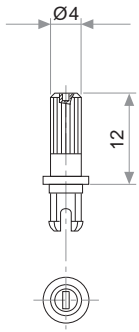

Fig. 3 / Ref. 5372

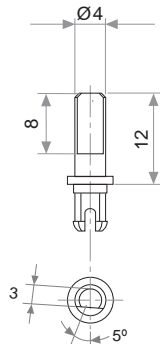

Fig. 15 / Ref. 5217

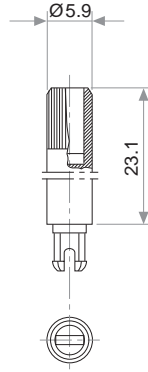

Fig. 17 / Ref. 5210

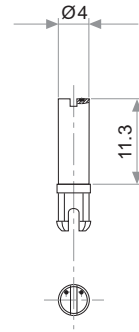

Fig. 18 / Ref. 5271

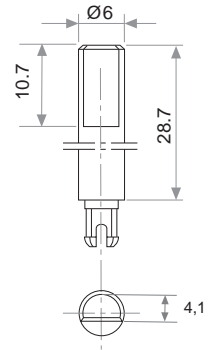

Fig. 19 / Ref. 6032*

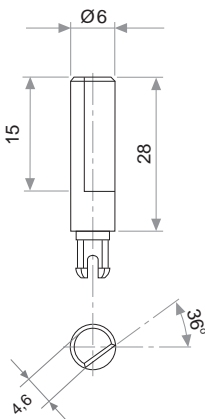

Fig. 20 / Ref. 5369*

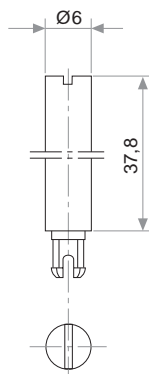

Fig. 21 / Ref. 6031*

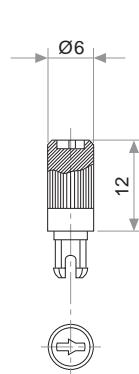

Fig. 22 / Ref. 6029

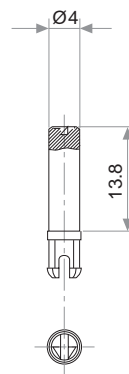

Fig. 23 / Ref. 6022

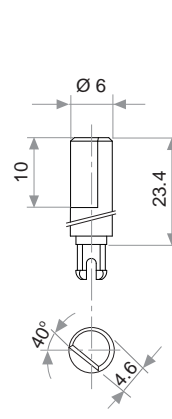

Fig. 29 / Ref. 6162

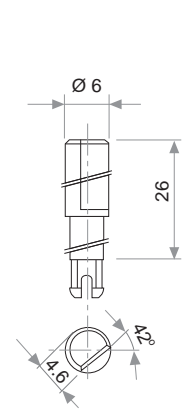

Fig. 25 / Ref. 6059

* Not available in self extinguishable plastic

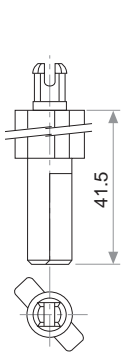

Fig. 27 / Ref. 5268*

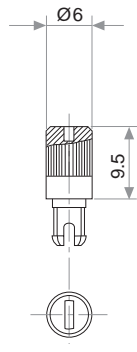

Fig. 28 / Ref. 6055

THUMBWHEEL

By default shafts, knobs & thumbwheels are delivered unassembled. Mounted shafts, knobs & thumbwheels are delivered at random position. Custom positioning available. If you wish to use your own plastic shaft/knob/actuator please contact Piher for advice about compatible materials.

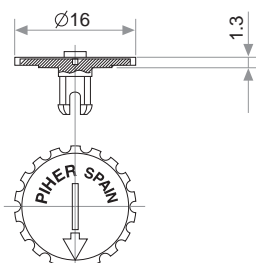

Fig. 4 / Ref. 5371

PACKAGING

Model	Units per box
Without shaft thumbwheel	400 (80 x 85 x 185 mm.)
With thumbwheel	200 (80 x 85 x 185 mm.)
With shaft	Contact Piher



DETENT CONFIGURATIONS EXAMPLES

This innovative PT's with detents family has been specifically developed to allow the integration of otherwise large and expensive external mechanisms into the body of the potentiometer thus allowing a high range of configurations: special tapers, torque, tolerances, linearity, cut track, etc.

This detent design not only adds a "click" sensation of position, but also offers enormous savings in both cost and space for any given application.

Strong and weak detents can be mixed as per customer's request.

Detent number and positions can be made or fitted to the customer needs or preferences.

 Relative detent positions along the total mechanical travel. Unless otherwise specified the detents are evenly spaced (using the end points as reference)

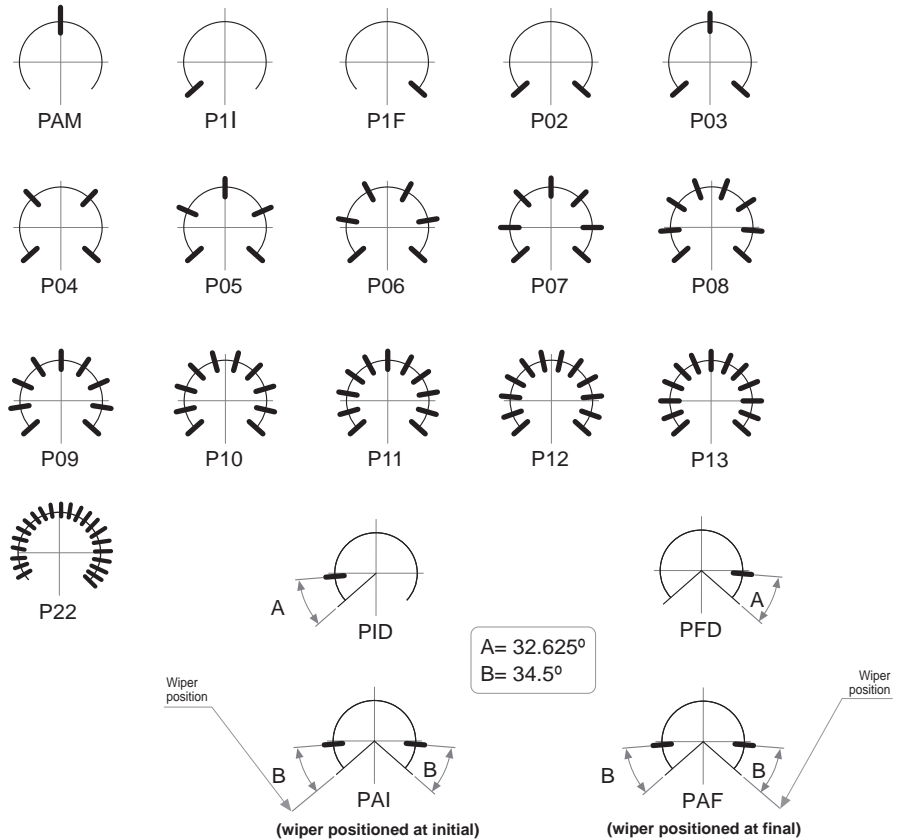

NOTES FOR DETENTED VERSIONS:

- (1) For the following mounting methods, the detents configurations will be studied individually case by case:
 - V02 & V21
 - V12 & V22
 - V18
 - V24
- (2) For more than 13 detents versions please contact your nearest PIHER authorised distributor.
- (3) Standard mechanical life is 500 cycles.
- (4) Long life versions are available under request and have the following characteristics at T^a:
 - Potentiometers with 1 to 3 detents: up to 10K cycles
 - Potentiometers with 4 and more detents: up to 5K cycles
- (5) Detent torque can vary from 1.2 to 2.5 times the standard potentiometer torque.

For all detents versions of more than 13 detents the detent torque will be 0.5 to 3.5 Ncm.
- (6) Please consult your nearest Piher supplier if unique non-overlapping values at each detent position or LOG/ALOG tapers are required.
- (7) Different output voltage values can be matched at each detent position (upon request).

DETENTS WITH CONSTANT VALUE ZONES

upon request

PIHER's potentiometers may feature special stepped outputs or 'constant voltage zones' for the 6, 10 and 15mm product families.

These constant voltage zones can be combined with PIHER's mechanical detents to provide exact alignment between the electrical output (flat areas) and the mechanical detent's positions. The result is a higher level of precision in controlling lighting, temperature, motor or other electronic control systems.

In addition to established catalogue detent configurations, we will design and manufacture any other configuration on our tried-and-tested carbon/cermet & THM/SMD potentiometer technology and processes.

With its exacting control capabilities, our 10mm and 15mm potentiometers series are well suited for many consumer applications such as ovens, ranges, dishwashers, lighting (dimmers), power hand tools, washing machines and HVAC systems.

Constant value zones can be combined with strategically located stops matching the flat areas of the output.

10 stepped outputs version example:

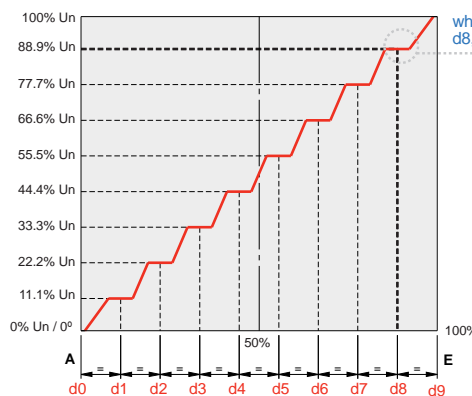

when the potentiometer's wiper position is located at detent d8, the output voltage will be 88.9% Un ± % tolerance.

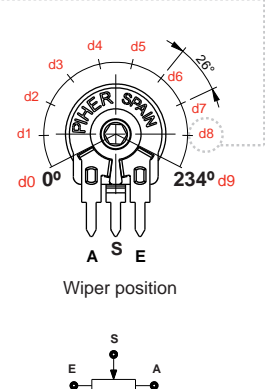

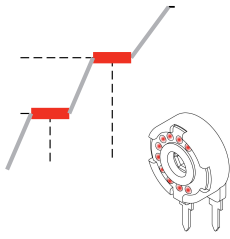

Improved repeatability

By combining the constant value zones with the detents, engineers can align the same voltage values with each of the detent stops when rotating the control both forward and backward.

This provides clear mechanical positions that are not only repeatable, but perfectly aligned electrical outputs at each of the (detent) angles.

Piher’s detents also prevent output values from changing due to vibration or accidental rotor movements, furthering reliable control consistency.

Design tip. Cost-effectiveness

Absolute encoders can easily be replaced connecting the potentiometer to the microprocessor’s analogue input.



Main advantages

- ✓ Unique, non-overlapping values at each stop (detent position)
- ✓ Prevents output value change due to light vibration or accidental rotor micro-movements
- ✓ Fully customisable according to customer’s needs
- ✓ Cost effective replacement for absolute encoders

Disclaimer

The product information in this catalogue is for reference purposes. Please consult for the most up to date and accurate design information.

Piher Sensors & Controls S.A., its affiliates, agents, and employees, and all persons acting on its or their behalf (collectively, “Piher”), disclaim any and all liability for any errors, inaccuracies or incompleteness contained herein or in any other disclosure relating to any product described herein.

Piher disclaims any and all liability arising out of the use or application of any product described herein or of any information provided herein to the maximum extent permitted by law. The product specifications do not expand or otherwise modify Piher’s terms and conditions of sale, including but not limited to the warranty expressed therein, which apply to these products.

No licence, express or implied, by estoppel or otherwise, to any intellectual property rights is granted by this document or by any conduct of Piher.

The products shown herein are not designed for use in medical, life-saving, or life-sustaining applications unless otherwise expressly indicated. Customers using or selling Piher products not expressly indicated for use in such applications do so entirely at their own risk and agree to fully indemnify Piher for any damages arising or resulting from such use or sale. Please contact authorised Piher personnel to obtain written terms and conditions regarding products designed for such applications.

Product names and markings noted herein may be trademarks of their respective owners.

Information contained in and/or attached to this catalogue may be subject to export control regulations of the European Community, USA, or other countries. Each recipient of this document is responsible to ensure that usage and/or transfer of any information contained in this document complies with all relevant export control regulations. If you are in any doubt about the export control restrictions that apply to this information, please contact the sender immediately. For any Piher Exports, Note: All products / technologies are EAR99 Classified commodities. Exports from the United States are in accordance with the Export Administration Regulations. Diversion contrary to US law is prohibited.

Piher is an Amphenol™ company.

3D models
in our
web

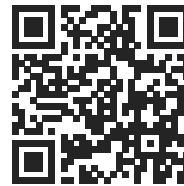

RoHS
compliant

All Piher products can be adapted to meet customer’s requirements.

Due to continuous process improvement, specifications are subject to change without notice.

Please always use the datasheets published at our website www.piher.net for the most up-to-date information.

v090419

Contact

Piher Sensing Systems
Poligono Industrial Municipal
Vial T2 N°22
31500 Tudela - Spain
Tel: +34-948-820450

sales@piher.net

www.piher.net