

## STELLA-A

Type II and III beam for street lighting.  
Compatible with up to 23 mm LES size COBs.  
Variant with black frame.

### TECHNICAL SPECIFICATIONS:

Dimensions	Ø 90.0 mm
Height	22 mm
Fastening	screw
Ingress protection classes	IP67
ROHS compliant	yes ⓘ



### MATERIAL SPECIFICATIONS:

Component	Type	Material	Colour	Finish
STELLA-A	Single lens	Silicone	clear	
STELLA-FRAME	Holder	PA66	black	





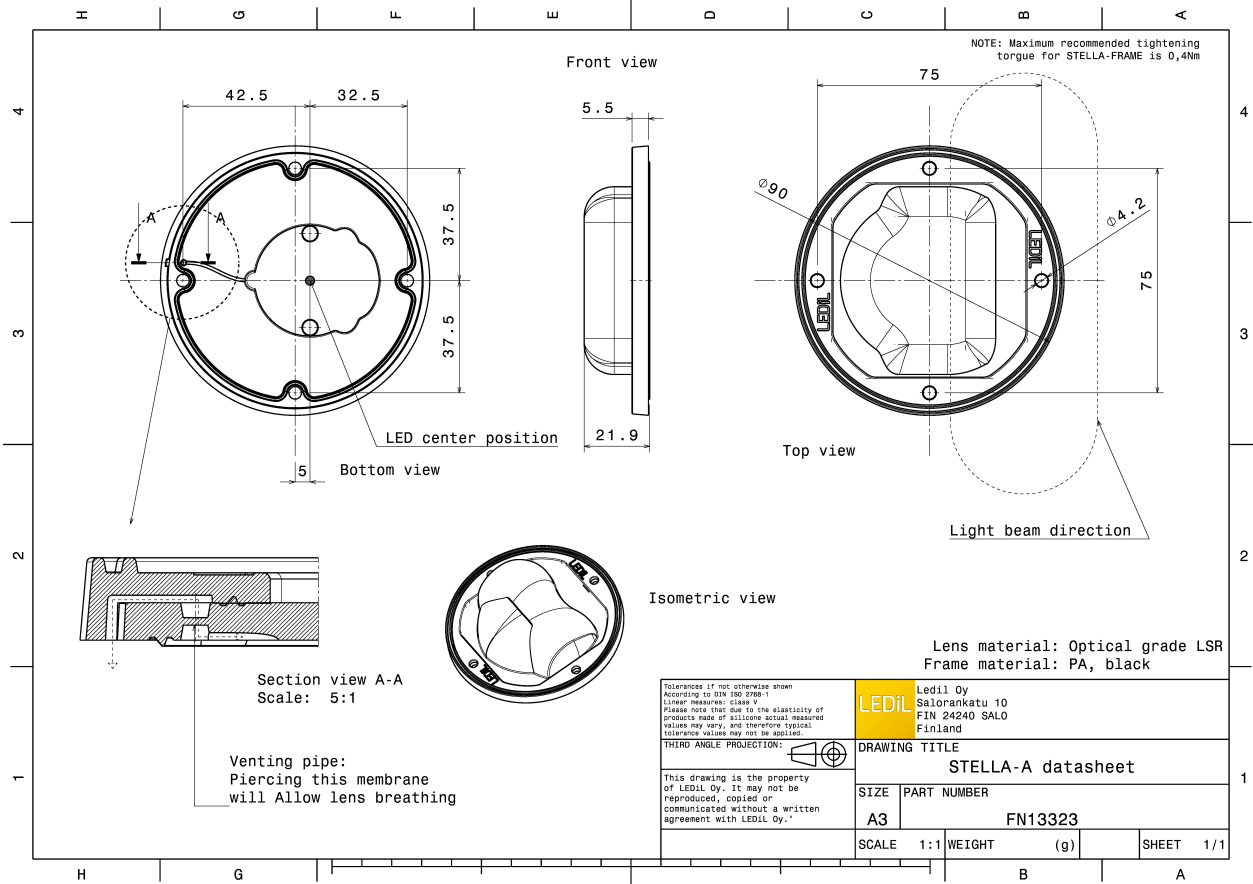

### ORDERING INFORMATION:

Component		Qty in box	MOQ	MPQ	Box weight (kg)
FN13323_STELLA-A	Single lens	100	50	10	6.6
» Box size:					

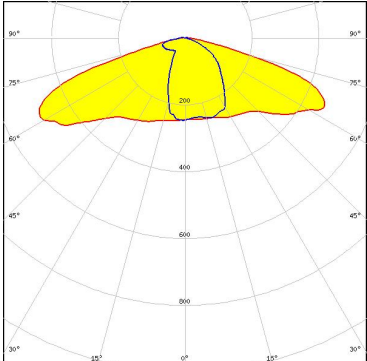

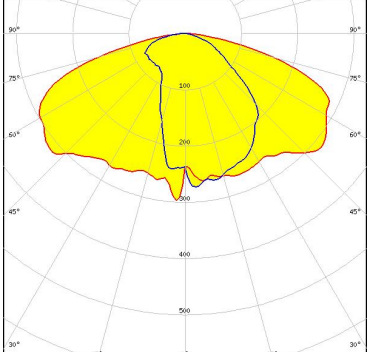
See also our general installation guide: [www.ledil.com/installation\\_guide](http://www.ledil.com/installation_guide)

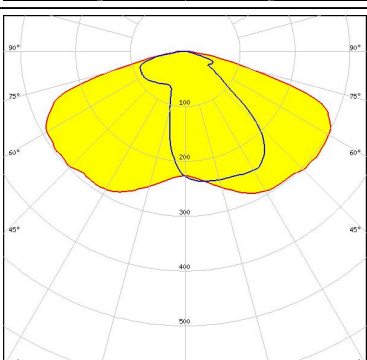
### PHOTOMETRIC DATA (MEASURED):

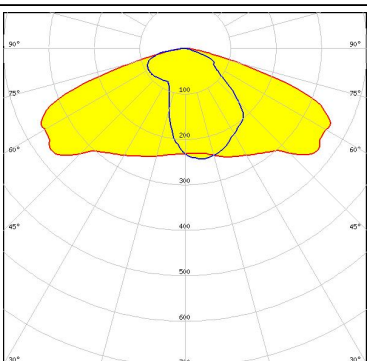
<p></p> <p>LED V15 Gen6            FWHM / FWTM Asymmetric            Efficiency 91 %            Peak intensity 0.6 cd/lm            LEDs/each optic 1            Light colour White            Required components:</p>	
<p></p> <p>LED V18 Gen7            FWHM / FWTM Asymmetric            Efficiency 85 %            Peak intensity 0.4 cd/lm            LEDs/each optic 1            Light colour White            Required components:</p>	
<p></p> <p>LED VERO13            FWHM / FWTM Asymmetric            Efficiency 92 %            Peak intensity 0.7 cd/lm            LEDs/each optic 1            Light colour White            Required components:</p>	
<p></p> <p>LED VERO18            FWHM / FWTM Asymmetric            Efficiency 92 %            Peak intensity 0.5 cd/lm            LEDs/each optic 1            Light colour White            Required components:</p>	

### PHOTOMETRIC DATA (MEASURED):

#### CITIZEN

LED CLL03x/CLU03x  
 FWHM / FWTM Asymmetric  
 Efficiency 92 %  
 Peak intensity 0.6 cd/lm  
 LEDs/each optic 1  
 Light colour White  
 Required components:  
 Bender Wirth: 433 Typ L1

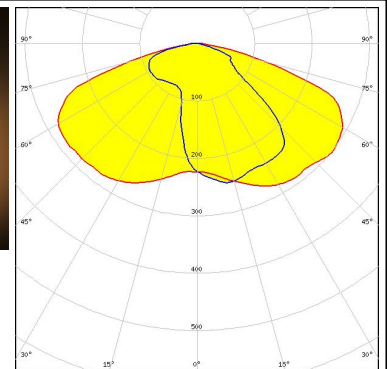
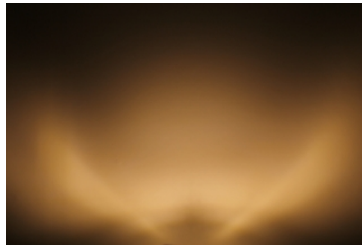

#### CITIZEN

LED CLU700/701/702  
 FWHM / FWTM Asymmetric  
 Efficiency 89 %  
 Peak intensity 1.4 cd/lm  
 LEDs/each optic 1  
 Light colour White  
 Required components:  
 Bender Wirth: 434 Typ L1

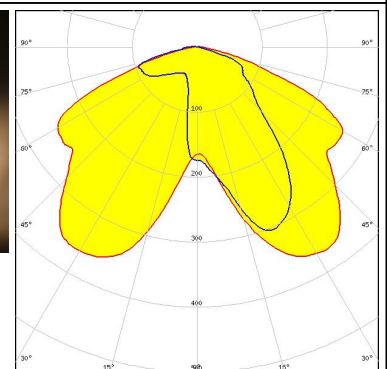
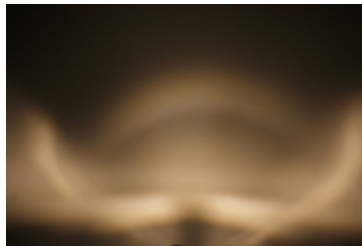

#### CITIZEN

LED CLU710/711  
 FWHM / FWTM Asymmetric  
 Efficiency 89 %  
 Peak intensity 1 cd/lm  
 LEDs/each optic 1  
 Light colour White  
 Required components:

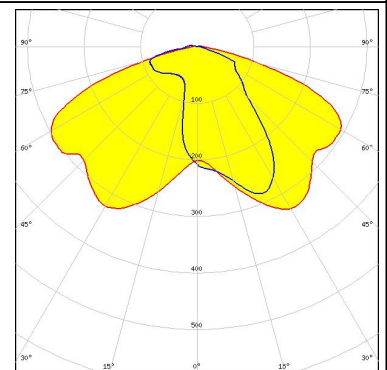

#### CITIZEN

LED CLU720/721  
 FWHM / FWTM Asymmetric  
 Efficiency 91 %  
 Peak intensity 0.8 cd/lm  
 LEDs/each optic 1  
 Light colour White  
 Required components:  
 Bender Wirth: 433 Typ L1

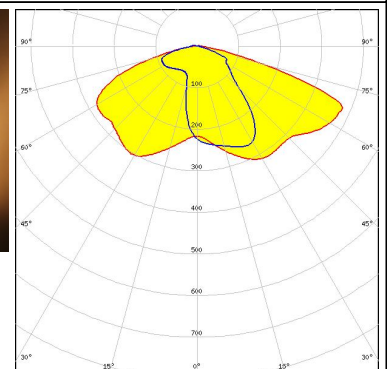
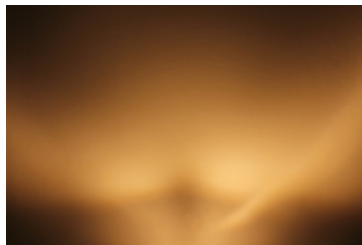

### PHOTOMETRIC DATA (MEASURED):

#### CITIZEN

LED CLU720/721  
 FWHM / FWTM Asymmetric  
 Efficiency %  
 Peak intensity 0.7 cd/lm  
 LEDs/each optic 1  
 Light colour White  
 Required components:

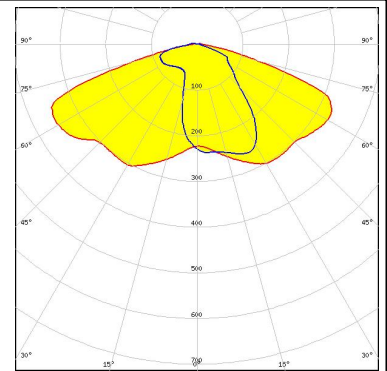

#### CREE

LED CXA/B 15xx  
 FWHM / FWTM Asymmetric  
 Efficiency 92 %  
 Peak intensity 0.9 cd/lm  
 LEDs/each optic 1  
 Light colour White  
 Required components:  
 Bender Wirth: 441 Typ L1

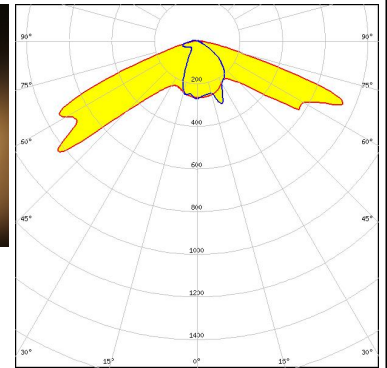
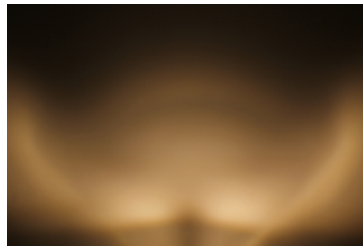

#### CREE

LED CXA/B 15xx  
 FWHM / FWTM Asymmetric  
 Efficiency 92 %  
 Peak intensity 1.1 cd/lm  
 LEDs/each optic 1  
 Light colour White  
 Required components:

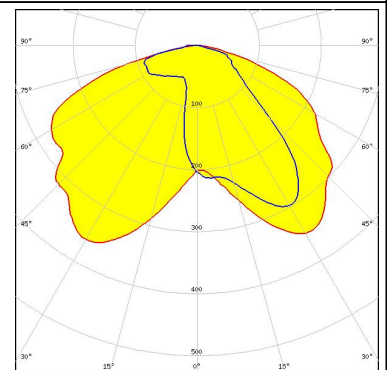

#### CREE

LED CXA/B 15xx  
 FWHM / FWTM Asymmetric  
 Efficiency 89 %  
 Peak intensity 1 cd/lm  
 LEDs/each optic 1  
 Light colour White  
 Required components:  
 C14305\_STELLA-CLAMP-CXA15-18

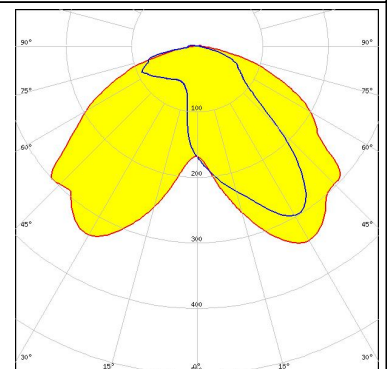

### PHOTOMETRIC DATA (MEASURED):



LED CXA/B 1816 & CXA/B 1820 & CXA 1850  
 FWHM / FWTM Asymmetric  
 Efficiency 87 %  
 Peak intensity 0.7 cd/lm  
 LEDs/each optic 1  
 Light colour White  
 Required components:

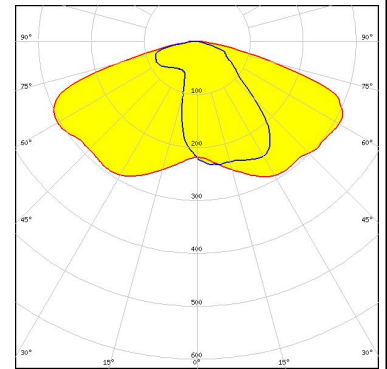

LED CXA/B 1816 & CXA/B 1820 & CXA 1850  
 FWHM / FWTM Asymmetric  
 Efficiency 89 %  
 Peak intensity 0.7 cd/lm  
 LEDs/each optic 1  
 Light colour White  
 Required components:  
 Bender Wirth: 437 Typ L1

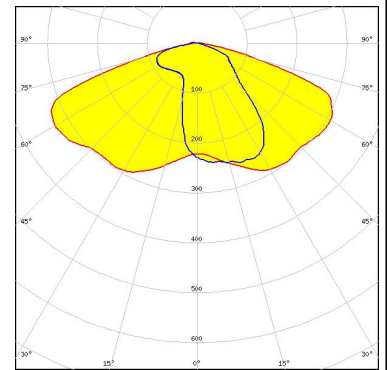

LED CXA/B 1816 & CXA/B 1820 & CXA 1850  
 FWHM / FWTM Asymmetric  
 Efficiency 92 %  
 Peak intensity 0.7 cd/lm  
 LEDs/each optic 1  
 Light colour White  
 Required components:  
 C14305\_STELLA-CLAMP-CXA15-18

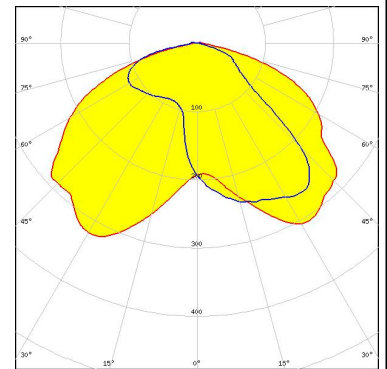

LED CXA/B 1816 & CXA/B 1820 & CXA 1850  
 FWHM / FWTM Asymmetric  
 Efficiency 87 %  
 Peak intensity 0.6 cd/lm  
 LEDs/each optic 1  
 Light colour White  
 Required components:

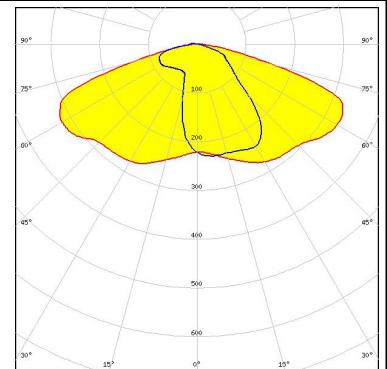



### PHOTOMETRIC DATA (MEASURED):



LED CXA/B 25xx  
 FWHM / FWTM Asymmetric  
 Efficiency 93 %  
 Peak intensity 0.5 cd/lm  
 LEDs/each optic 1  
 Light colour White  
 Required components:

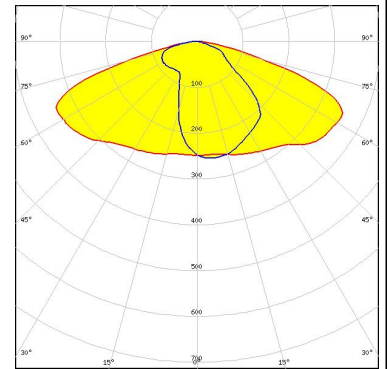

LED LUXEON CoB 1202/1203  
 FWHM / FWTM Asymmetric  
 Efficiency 88 %  
 Peak intensity 0.9 cd/lm  
 LEDs/each optic 1  
 Light colour White  
 Required components:  
 Bender Wirth: 438 Typ L1

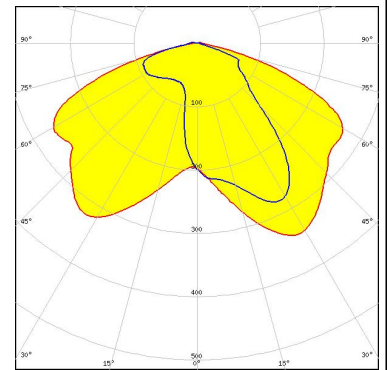

LED LUXEON CoB 1208  
 FWHM / FWTM Asymmetric  
 Efficiency %  
 Peak intensity 0.3 cd/lm  
 LEDs/each optic 1  
 Light colour White  
 Required components:

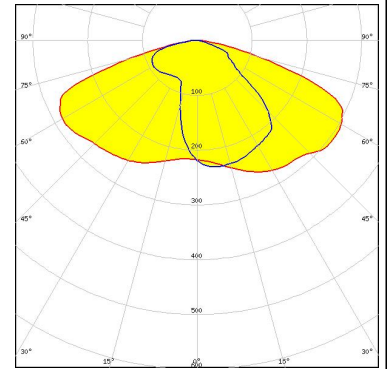

LED CxM-14 (19x19)  
 FWHM / FWTM Asymmetric  
 Efficiency 90 %  
 Peak intensity 0.6 cd/lm  
 LEDs/each optic 1  
 Light colour White  
 Required components:

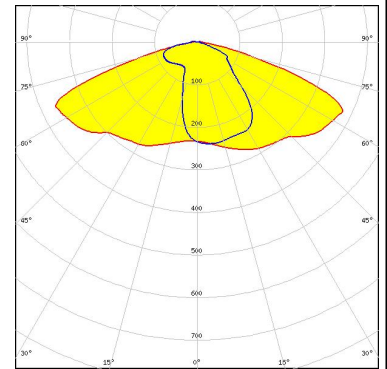

### PHOTOMETRIC DATA (MEASURED):

<p><b>LUMINUS</b></p> <p>LED CxM-18 (21.5x21.5)            FWHM / FWTM Asymmetric            Efficiency 89 %            Peak intensity 0.5 cd/lm            LEDs/each optic 1            Light colour White            Required components:</p>	
<p><b>NICHIA</b></p> <p>LED COB J-Type            FWHM / FWTM Asymmetric            Efficiency 87 %            Peak intensity 0.5 cd/lm            LEDs/each optic 1            Light colour White            Required components:</p>	
<p><b>NICHIA</b></p> <p>LED COB L-Type (LES 11)            FWHM / FWTM Asymmetric            Efficiency 89 %            Peak intensity 0.7 cd/lm            LEDs/each optic 1            Light colour White            Required components:            Bender Wirth: 438 Typ L1</p>	
<p><b>NICHIA</b></p> <p>LED COB L-Type (LES 9)            FWHM / FWTM Asymmetric            Efficiency 90 %            Peak intensity 0.9 cd/lm            LEDs/each optic 1            Light colour White            Required components:            Bender Wirth: 438 Typ L1</p>	



### PHOTOMETRIC DATA (MEASURED):

#### OSRAM

Opto Semiconductors

LED Soleriq S13  
 FWHM / FWTM Asymmetric  
 Efficiency 92 %  
 Peak intensity 0.7 cd/lm  
 LEDs/each optic 1  
 Light colour White  
 Required components:  
 Bender Wirth: 437 Typ L1

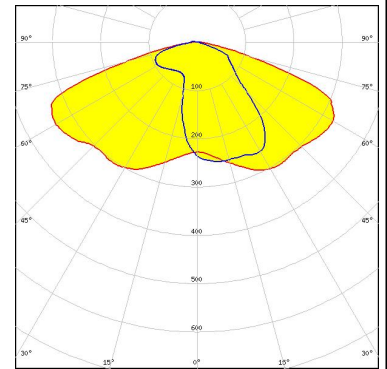

#### OSRAM

Opto Semiconductors

LED Soleriq S13  
 FWHM / FWTM Asymmetric  
 Efficiency 91 %  
 Peak intensity 0.7 cd/lm  
 LEDs/each optic 1  
 Light colour White  
 Required components:

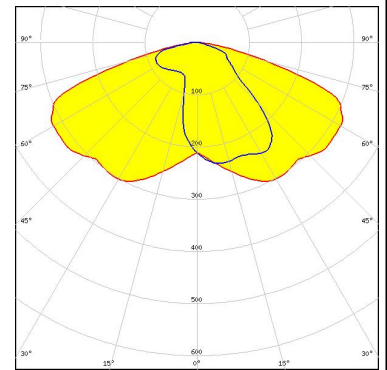

#### OSRAM

Opto Semiconductors

LED Soleriq S19  
 FWHM / FWTM Asymmetric  
 Efficiency 90 %  
 Peak intensity 0.5 cd/lm  
 LEDs/each optic 1  
 Light colour White  
 Required components:

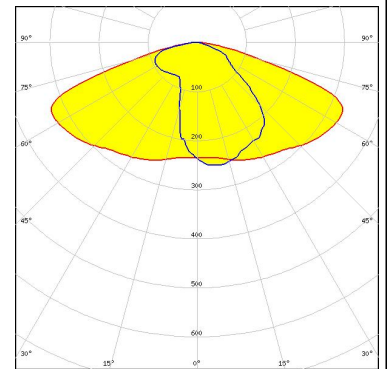

#### SAMSUNG

LED LC016D / LC019D / LC026D / LC033D  
 FWHM / FWTM Asymmetric  
 Efficiency 87 %  
 Peak intensity 0.5 cd/lm  
 LEDs/each optic 1  
 Light colour White  
 Required components:

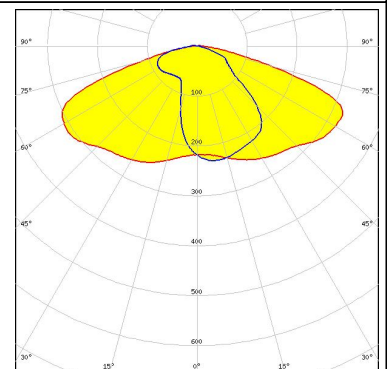



## PHOTOMETRIC DATA (MEASURED):

### SHARP

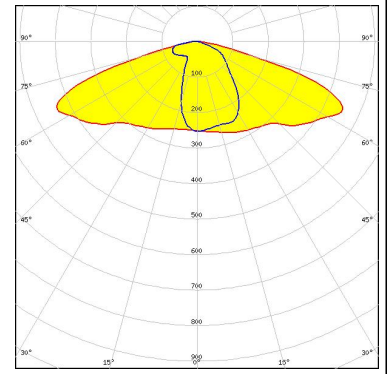
LED Mega Zenigata (GW6DME)  
FWHM / FWTM Asymmetric  
Efficiency 90 %  
Peak intensity 0.6 cd/lm  
LEDs/each optic 1  
Light colour White  
Required components:

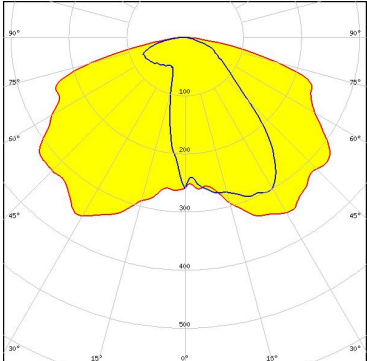

### PHOTOMETRIC DATA (SIMULATED):

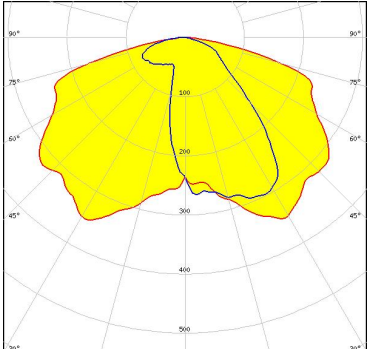
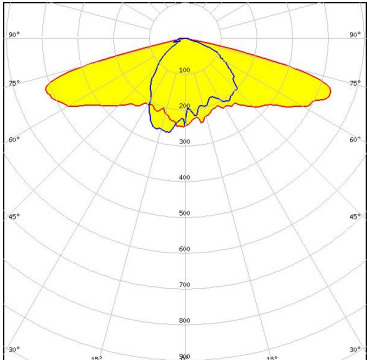
<p> LED V10 Gen7 FWHM / FWTM Asymmetric Efficiency 89 % Peak intensity 0.6 cd/lm LEDs/each optic 1 Light colour White Required components: Bender Wirth: 486 Typ L1</p>	
<p> LED V13 Gen7 FWHM / FWTM Asymmetric Efficiency 89 % Peak intensity 0.6 cd/lm LEDs/each optic 1 Light colour White Required components: Bender Wirth: 477 Typ L1</p>	
<p><b>CITIZEN</b> LED CLL02x/CLU02x (LES10) FWHM / FWTM Asymmetric Efficiency 91 % Peak intensity 0.7 cd/lm LEDs/each optic 1 Light colour White Required components:</p>	

### GENERAL INFORMATION:

NOTE: The typical beam angle will be changed by different color, chip size and chip position tolerance. The typical total beam angle is the full angle measured where the luminous intensity is half of the peak value.

Due to use of high power COB's with this product, special attention to proper thermal design is highly recommended. LEDiL has no liability for direct, indirect or consecutive damages arising from the LEDiL products being used outside of the recommended temperature range.

### MATERIALS:

As part of our continuous research and improvement processes, and to ensure the best possible quality and availability of our products, LEDiL reserves the right to change material grades without notice.

### PRODUCT DATA USER AGREEMENT AND DISCLAIMER:

The measured data in the provided downloadable LEDiL Product Datasheets and Mechanical 2D-Drawings is rounded and provided as reference for planning. LEDiL Oy's optical specifications have been verified by conducting performance testing of the products in accordance with the company's quality system. The reported data are averaged results of multiple measurements with typical variation. LEDiL Oy reserves the right to without prior notification make changes and improvements to its products.

LEDiL Oy assumes neither warranty, nor guarantee nor any other liability of any kind for the contents and correctness of the provided data. The provided data has been generated with highest diligence but the provided data may in reality not represent the complete possible variation range of all intrinsic parameters. Therefore, in certain cases a deviation from the provided data could occur.

LEDiL Oy reserves the right to undertake technical changes of its products without further notification which could lead to changes in the provided data. LEDiL Oy assumes no liability of any kind for the possible deviation from any provided data or any other damage resulting from the usage of the provided data.

The user agrees to this disclaimer and user agreement with the download or usage of the provided files.

#### LEDiL Oy

Joensuunkatu 13  
FI-24240 SALO  
Finland

#### LEDiL Inc.

228 West Page Street  
Suite D  
Sycamore IL 60178  
USA

#### Ledil Optics Technology (Shenzhen) Co., Ltd.

# 405 , Block B  
Casic Motor Building  
Shenzhen 518057  
P.R.CHINA

#### Local sales and technical support

[www.ledil.com/  
where\\_to\\_buy](http://www.ledil.com/where_to_buy)

#### Shipping locations

Salo, Finland  
Hong Kong, China

#### Distribution Partners

[www.ledil.com/  
where\\_to\\_buy](http://www.ledil.com/where_to_buy)