

General Description

The AO6402A uses advanced trench technology to provide excellent $R_{DS(ON)}$ and low gate charge. This device is suitable for use as a load switch or in PWM applications. The source leads are separated to allow a Kelvin connection to the source, which may be used to bypass the source inductance.

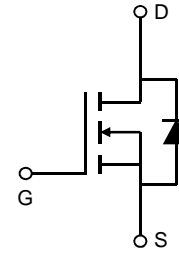

Features

- $V_{DS} (V) = 30V$
- $I_D = 7.5A$ ($V_{GS} = 10V$)
- $R_{DS(ON)} < 24m\Omega$ ($V_{GS} = 10V$)
- $R_{DS(ON)} < 35m\Omega$ ($V_{GS} = 4.5V$)

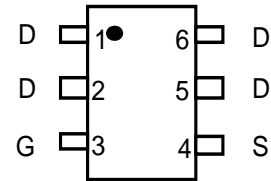

SOT23-6

Absolute Maximum Ratings $T_A=25^\circ C$ unless otherwise noted

Parameter	Symbol	Maximum	Units
Drain-Source Voltage	V_{DS}	30	V
Gate-Source Voltage	V_{GS}	± 20	V
Continuous Drain Current ^{A,F}	I_D	7.5	A
$T_A=25^\circ C$		6.0	
Pulsed Drain Current ^B	I_{DM}	64	
Power Dissipation	P_D	2.0	W
		$T_A=25^\circ C$	
Junction and Storage Temperature Range	T_J, T_{STG}	-55 to 150	$^\circ C$

Thermal Characteristics					
Parameter	Symbol	Typ	Max	Units	
Maximum Junction-to-Ambient ^A	$R_{\theta JA}$	48	62.5	$^\circ C/W$	
$t \leq 10s$		74	110	$^\circ C/W$	
Maximum Junction-to-Ambient ^A	$R_{\theta JL}$	54	68	$^\circ C/W$	
Steady-State		54	68	$^\circ C/W$	
Maximum Junction-to-Lead ^C				$^\circ C/W$	

Electrical Characteristics ($T_J=25^\circ\text{C}$ unless otherwise noted)

Symbol	Parameter	Conditions	Min	Typ	Max	Units
STATIC PARAMETERS						
BV_{DSS}	Drain-Source Breakdown Voltage	$I_D=250\mu\text{A}, V_{GS}=0\text{V}$	30			V
I_{DSS}	Zero Gate Voltage Drain Current	$V_{DS}=30\text{V}, V_{GS}=0\text{V}$ $T_J=55^\circ\text{C}$			1	μA
					5	
I_{GSS}	Gate-Body leakage current	$V_{DS}=0\text{V}, V_{GS}=\pm 20\text{V}$			100	nA
$V_{GS(th)}$	Gate Threshold Voltage	$V_{DS}=V_{GS}, I_D=250\mu\text{A}$	1.5	2.1	2.6	V
$I_{D(ON)}$	On state drain current	$V_{GS}=10\text{V}, V_{DS}=5\text{V}$	64			A
$R_{DS(ON)}$	Static Drain-Source On-Resistance	$V_{GS}=10\text{V}, I_D=7.5\text{A}$		17.3	24	$\text{m}\Omega$
		$V_{GS}=4.5\text{V}, I_D=5.6\text{A}$		25	35	$\text{m}\Omega$
g_{FS}	Forward Transconductance	$V_{DS}=5\text{V}, I_D=7.5\text{A}$		20		S
V_{SD}	Diode Forward Voltage	$I_S=1\text{A}, V_{GS}=0\text{V}$		0.75	1	V
I_S	Maximum Body-Diode Continuous Current				2.5	A
DYNAMIC PARAMETERS						
C_{iss}	Input Capacitance	$V_{GS}=0\text{V}, V_{DS}=15\text{V}, f=1\text{MHz}$		373	448	pF
C_{oss}	Output Capacitance			67		pF
C_{rss}	Reverse Transfer Capacitance			41		pF
R_g	Gate resistance	$V_{GS}=0\text{V}, V_{DS}=0\text{V}, f=1\text{MHz}$		2	2.8	Ω
SWITCHING PARAMETERS						
$Q_g(10\text{V})$	Total Gate Charge	$V_{GS}=10\text{V}, V_{DS}=15\text{V}, I_D=7.5\text{A}$		7.2	11	nC
$Q_g(4.5\text{V})$	Total Gate Charge			3.5	5	nC
Q_{gs}	Gate Source Charge			1.3		nC
Q_{gd}	Gate Drain Charge			1.7		nC
$t_{D(on)}$	Turn-On DelayTime	$V_{GS}=10\text{V}, V_{DS}=15\text{V}, R_L=2\Omega,$ $R_{GEN}=3\Omega$		4.5	6.5	ns
t_r	Turn-On Rise Time			2.7	4.5	ns
$t_{D(off)}$	Turn-Off DelayTime			14.9	23	ns
t_f	Turn-Off Fall Time			2.9	5.5	ns
t_{rr}	Body Diode Reverse Recovery Time	$I_F=7.5\text{A}, dI/dt=100\text{A}/\mu\text{s}$		10.5	12.6	ns
Q_{rr}	Body Diode Reverse Recovery Charge	$I_F=7.5\text{A}, dI/dt=100\text{A}/\mu\text{s}$		4.5	5.4	nC

A: The value of $R_{\theta JA}$ is measured with the device mounted on 1in² FR-4 board with 2oz. Copper, in a still air environment with $T_A=25^\circ\text{C}$. The value in any given application depends on the user's specific board design. The current rating is based on the $t \leq 10\text{s}$ thermal resistance rating.

B: Repetitive rating, pulse width limited by junction temperature.

C: The $R_{\theta JA}$ is the sum of the thermal impedance from junction to lead $R_{\theta JL}$ and lead to ambient.

D: The static characteristics in Figures 1 to 6 are obtained using $<300\mu\text{s}$ pulses, duty cycle 0.5% max.

E: These tests are performed with the device mounted on 1 in² FR-4 board with 2oz. Copper, in a still air environment with $T_A=25^\circ\text{C}$. The SOA curve provides a single pulse rating.

F: The current rating is based on the $t \leq 10\text{s}$ thermal resistance rating.

TYPICAL ELECTRICAL AND THERMAL CHARACTERISTICS

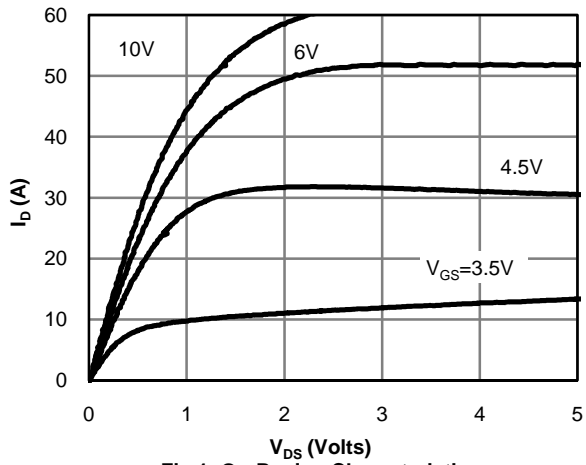

Fig 1: On-Region Characteristics

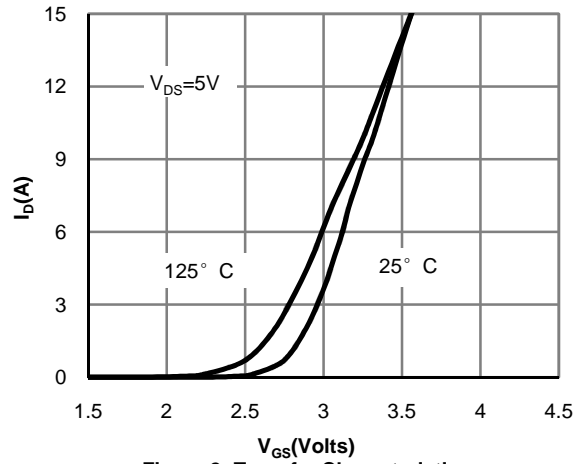

Figure 2: Transfer Characteristics

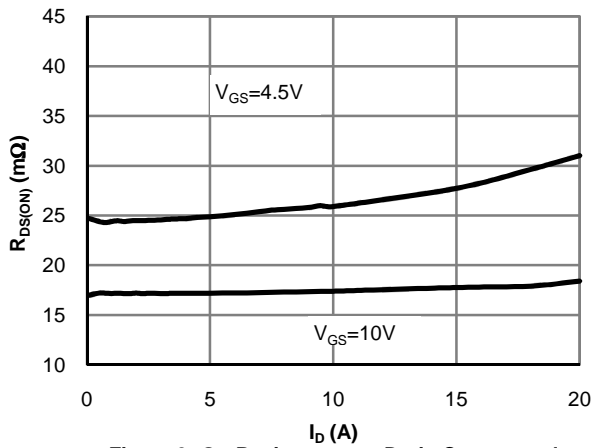

Figure 3: On-Resistance vs. Drain Current and Gate Voltage

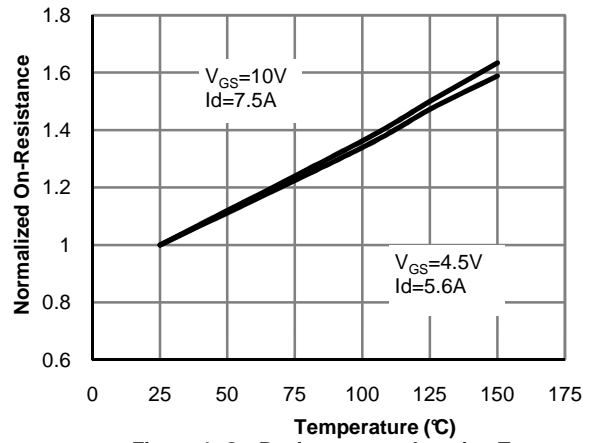

Figure 4: On-Resistance vs. Junction Temperature

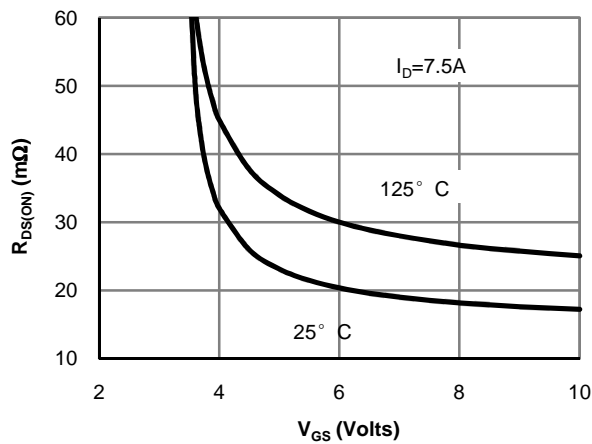

Figure 5: On-Resistance vs. Gate-Source Voltage

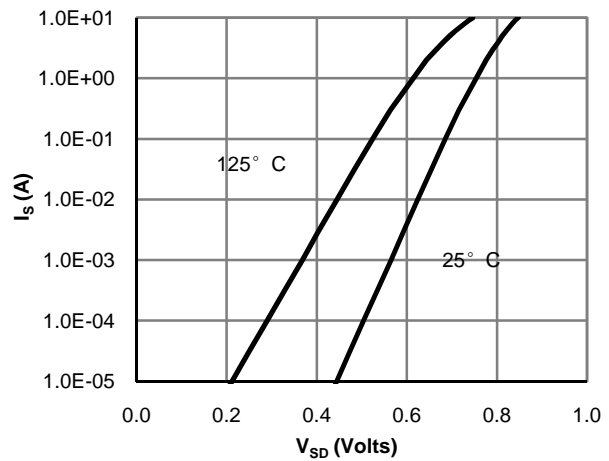

Figure 6: Body-Diode Characteristics

TYPICAL ELECTRICAL AND THERMAL CHARACTERISTICS

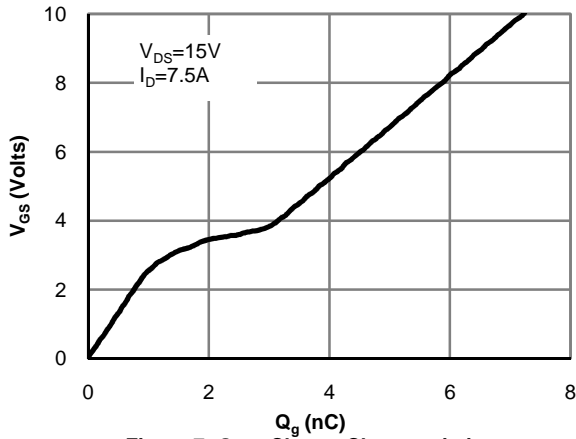

Figure 7: Gate-Charge Characteristics

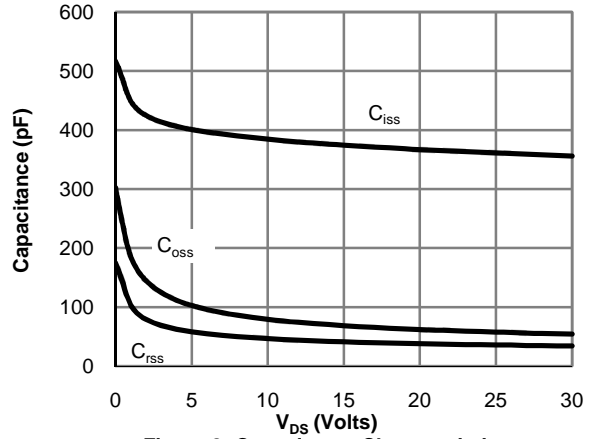

Figure 8: Capacitance Characteristics

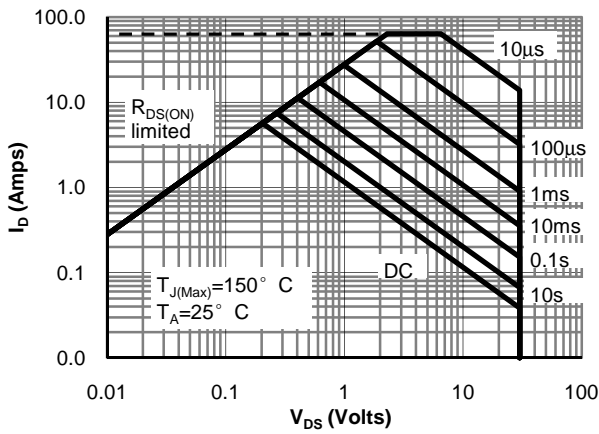

Figure 9: Maximum Forward Biased Safe Operating Area (Note E)

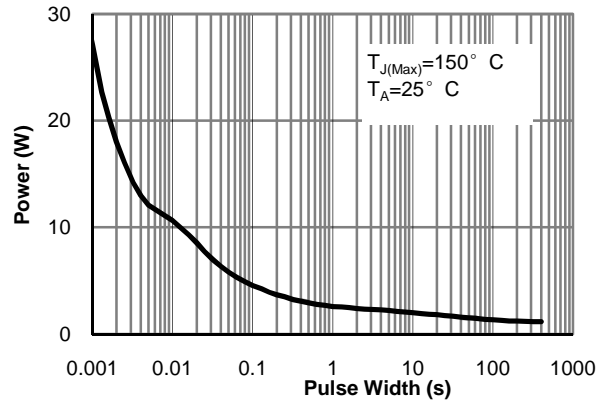

Figure 10: Single Pulse Power Rating Junction-to-Ambient (Note E)

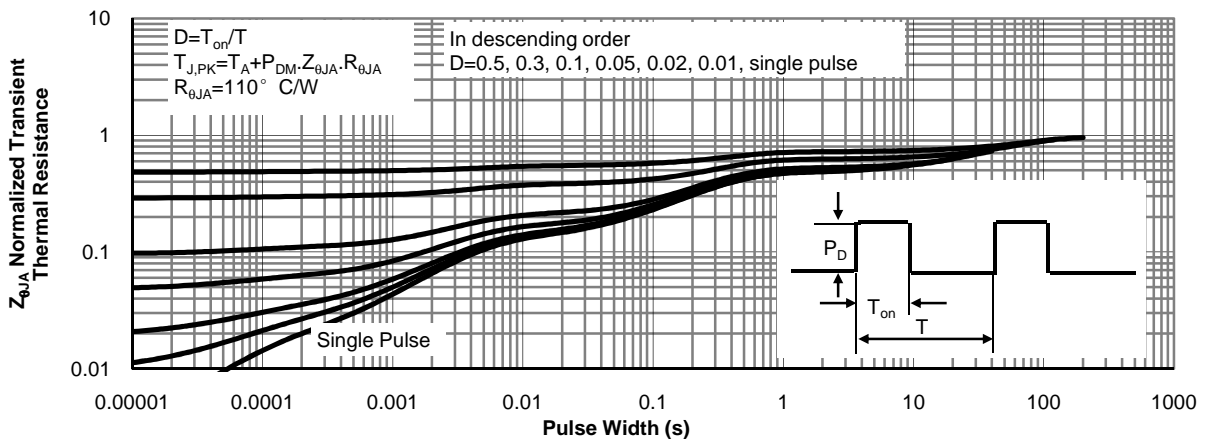
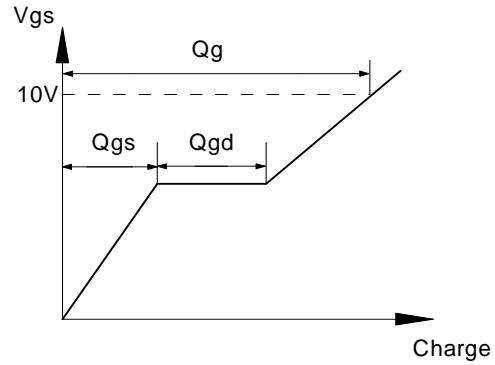
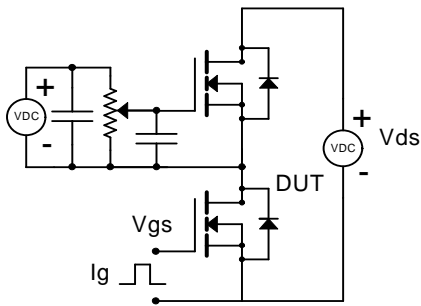
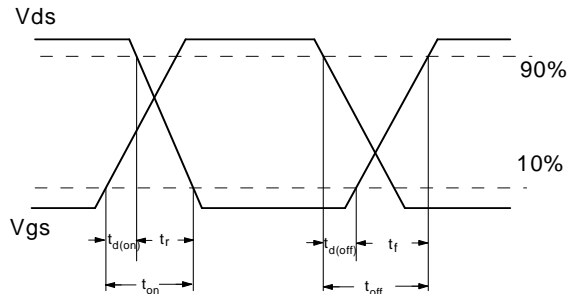
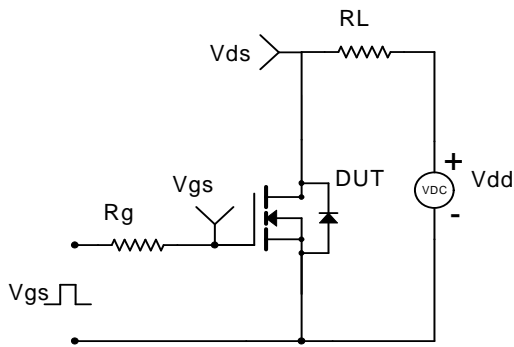

Figure 11: Normalized Maximum Transient Thermal Impedance

Gate Charge Test Circuit & Waveform



Resistive Switching Test Circuit & Waveforms



Diode Recovery Test Circuit & Waveforms

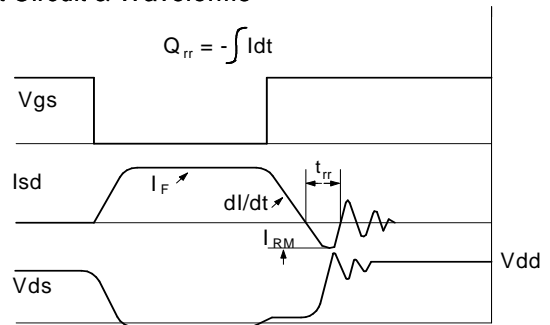
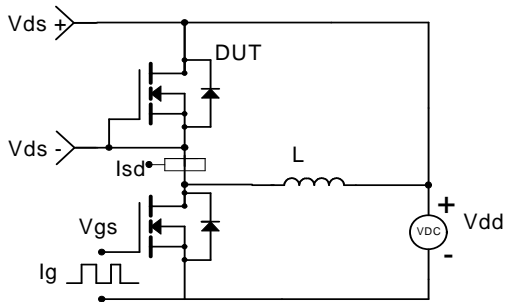

SOT23- 6 PACKAGE OUTLIE DIMENSIONS

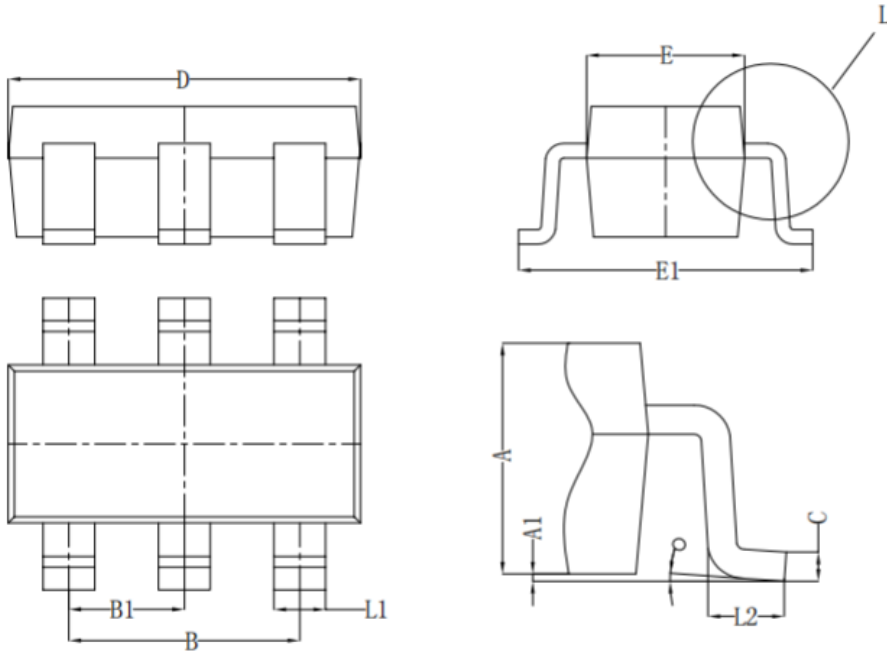

Symbol	Dim in mm		
	Min	Nor	Max
A	1.050	1.100	1.150
A1	0.000	0.050	0.100
L1	0.300	0.400	0.500
C	0.100	0.150	0.200
D	2.820	2.920	3.020
E	1.500	1.600	1.700
E1	2.650	2.800	2.950
B	1.800	1.900	2.000
B1	0.950 TYP		
L2	0.300	0.450	0.600
o	0°	4°	8°

Marking

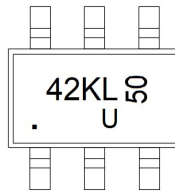

Ordering information

Order code	Package	Baseqty	Deliverymode
UMW AO6402A	SOT23-6	3000	Tape and reel