

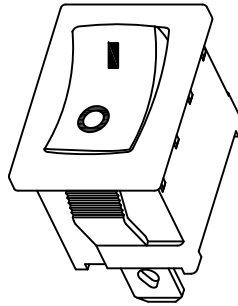

HONGJU ELECTRONIC

MR-1

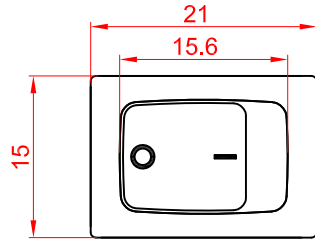

Rating: 10A 125V AC (UL CUL) 
 6A 250V AC (CQC TÜV CB )
 Contact Resistance: 50mΩ Max
 Insulation Resistance: DC 500V 100MΩ Min
 Dielectric Strength: AC1500V 1 minute
 Electrical life: 10,000 cycles
 Operating Temperature: 0°C ~ 85°C

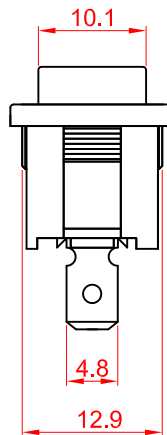
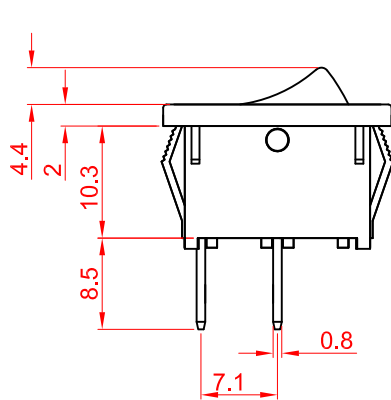

CUT-OUT

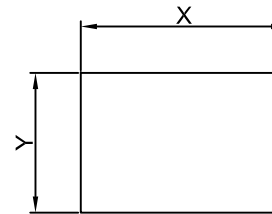

	X	Y
0.75~1.25	19.2-0.1	13.0+0.1
1.25~2.00	19.4-0.1	13.0+0.1
2.00~3.00	19.8-0.1	13.0+0.1

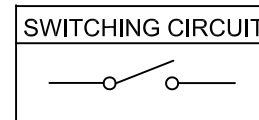

MATERIAL:

Body:Nylon66,UL rated:94V-2 min
 Actuator:Nylon66,UL rated:94V-2 min
 Terminal:Brass,silver or tin plated

0	1	2	3	4	5	7	8	9	A	B	C	D	E	G	H	J	L
None																	

				公差 TOLERANCES		.X± 0.3 .XX± 0.15		角度 ANGLE ± 1°		单位 DIMENSION UNIT		mm.	
				版本 VERSION	A1	比例尺 SCALE	NONE	日期 DATE	2014.07.17	品名 TITLE		图号 DRAWING NO	
				核准		核对		绘图		MR-1-110-CXN-BBAA		MR-1-110-CXN-BBAA_A1	
版本 VER.	变更说明 CHANGE DESCRIPTION	日期 DATE	ECN NO.	APPROVED BY		CHECKED BY		DRAWN BY					
A1	重新整理后发行	2014.07.17	N/A										