

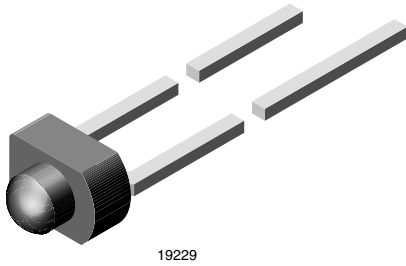

## Universal LED, Ø 1.8 mm Tinted Diffused Miniplast Package



### FEATURES

- Three colors
- For DC and pulse operation
- Luminous intensity categorized
- End-to-end stackable in center-to-center spacing of 0.1" (2.54 mm)
- Material categorization: for definitions of compliance please see [www.vishay.com/doc?99912](http://www.vishay.com/doc?99912)



### PRODUCT GROUP AND PACKAGE DATA

- Product group: LED
- Package: 1.8 mm (miniplast)
- Product series: standard
- Angle of half intensity: ± 20°

### APPLICATIONS

- General indicating and lighting purposes

PARTS TABLE														
PART	COLOR	LUMINOUS INTENSITY (mcd)			at I <sub>F</sub> (mA)	WAVELENGTH (nm)			at I <sub>F</sub> (mA)	FORWARD VOLTAGE (V)			at I <sub>F</sub> (mA)	TECHNOLOGY
		MIN.	TYP.	MAX.		MIN.	TYP.	MAX.		MIN.	TYP.	MAX.		
TLUO2400 <sup>(1)</sup>	Red	1.6	11	-	10	612	618	625	10	-	2	3	20	GaAsP on GaP
TLUO2401	Red	4	10	20	10	612	618	625	10	-	2	3	20	GaAsP on GaP
TLUY2400	Yellow	1	8	-	10	581	586	594	10	-	2.4	3	20	GaAsP on GaP
TLUY2401	Yellow	2.5	6	12.5	10	581	586	594	10	-	2.4	3	20	GaAsP on GaP
TLUY2401-AS12 <sup>(1)</sup>	Yellow	2.5	6	12.5	10	581	586	594	10	-	2.4	3	20	GaAsP on GaP
TLUG2400	Green	1.6	10	-	10	562	568	575	10	-	2.4	3	20	GaP on GaP
TLUG2401	Green	4	12	20	10	562	568	575	10	-	2.4	3	20	GaP on GaP

#### Note

<sup>(1)</sup> Not for new designs

ABSOLUTE MAXIMUM RATINGS (T <sub>amb</sub> = 25 °C, unless otherwise specified)					
TLUO240., TLUY240., TLUG240.					
PARAMETER	TEST CONDITION	PART	SYMBOL	VALUE	UNIT
Reverse voltage			V <sub>R</sub>	6	V
DC forward current		TLUO240.	I <sub>F</sub>	30	mA
		TLUY240.	I <sub>F</sub>	30	mA
		TLUG240.	I <sub>F</sub>	30	mA
Surge forward current	t <sub>p</sub> ≤ 10 μs		I <sub>FSM</sub>	1	A
Power dissipation	T <sub>amb</sub> ≤ 55 °C	TLUO240.	P <sub>V</sub>	100	mW
		TLUY240.	P <sub>V</sub>	100	mW
		TLUG240.	P <sub>V</sub>	100	mW
Junction temperature			T <sub>j</sub>	100	°C
Operating temperature range			T <sub>amb</sub>	-40 to +100	°C
Storage temperature range			T <sub>stg</sub>	-55 to +100	°C
Soldering temperature	t ≤ 3 s, 2 mm from body		T <sub>sd</sub>	260	°C
	t ≤ 5 s, 4 mm from body		T <sub>sd</sub>	260	°C
Thermal resistance junction/ambient		TLUO240.	R <sub>thJA</sub>	450	K/W
		TLUY240.	R <sub>thJA</sub>	450	K/W
		TLUG240.	R <sub>thJA</sub>	450	K/W

**OPTICAL AND ELECTRICAL CHARACTERISTICS** ( $T_{amb} = 25\text{ }^{\circ}\text{C}$ , unless otherwise specified)  
**TLUO240., RED**

PARAMETER	TEST CONDITION	PART	SYMBOL	MIN.	TYP.	MAX.	UNIT
Luminous intensity <sup>(1)</sup>	$I_F = 10\text{ mA}$	TLUO2400 <sup>(2)</sup>	$I_V$	1.6	11	-	mcd
		TLUO2401	$I_V$	4	10	20	mcd
Dominant wavelength	$I_F = 10\text{ mA}$		$\lambda_d$	612	618	625	nm
Peak wavelength	$I_F = 10\text{ mA}$		$\lambda_p$	-	630	-	nm
Angle of half intensity	$I_F = 10\text{ mA}$		$\phi$	-	$\pm 20$	-	$^{\circ}$
Forward voltage	$I_F = 20\text{ mA}$		$V_F$	-	2	3	V
Reverse voltage	$I_R = 10\text{ }\mu\text{A}$		$V_R$	6	15	-	V
Junction capacitance	$V_R = 0\text{ V}$ , $f = 1\text{ MHz}$		$C_j$	-	50	-	pF

**Notes**

- (1) In one packing unit  $I_{Vmin.}/I_{Vmax.} \leq 0.5$   
(2) Not for new designs

**OPTICAL AND ELECTRICAL CHARACTERISTICS** ( $T_{amb} = 25\text{ }^{\circ}\text{C}$ , unless otherwise specified)  
**TLUY240., YELLOW**

PARAMETER	TEST CONDITION	PART	SYMBOL	MIN.	TYP.	MAX.	UNIT
Luminous intensity <sup>(1)</sup>	$I_F = 10\text{ mA}$	TLUY2400	$I_V$	1	8	-	mcd
		TLUY2401	$I_V$	2.5	6	12.5	mcd
Dominant wavelength	$I_F = 10\text{ mA}$		$\lambda_d$	581	586	594	nm
Peak wavelength	$I_F = 10\text{ mA}$		$\lambda_p$	-	585	-	nm
Angle of half intensity	$I_F = 10\text{ mA}$		$\phi$	-	$\pm 20$	-	$^{\circ}$
Forward voltage	$I_F = 20\text{ mA}$		$V_F$	-	2.4	3	V
Reverse voltage	$I_R = 10\text{ }\mu\text{A}$		$V_R$	6	15	-	V
Junction capacitance	$V_R = 0\text{ V}$ , $f = 1\text{ MHz}$		$C_j$	-	50	-	pF

**Note**

- (1) In one packing unit  $I_{Vmin.}/I_{Vmax.} \leq 0.5$

**OPTICAL AND ELECTRICAL CHARACTERISTICS** ( $T_{amb} = 25\text{ }^{\circ}\text{C}$ , unless otherwise specified)  
**TLUG240., GREEN**

PARAMETER	TEST CONDITION	PART	SYMBOL	MIN.	TYP.	MAX.	UNIT
Luminous intensity <sup>(1)</sup>	$I_F = 10\text{ mA}$	TLUG2400	$I_V$	1.6	10	-	mcd
		TLUG2401	$I_V$	4	12	20	mcd
Dominant wavelength	$I_F = 10\text{ mA}$		$\lambda_d$	562	568	575	nm
Peak wavelength	$I_F = 10\text{ mA}$		$\lambda_p$	-	565	-	nm
Angle of half intensity	$I_F = 10\text{ mA}$		$\phi$	-	$\pm 20$	-	$^{\circ}$
Forward voltage	$I_F = 20\text{ mA}$		$V_F$	-	2.4	3	V
Reverse voltage	$I_R = 10\text{ }\mu\text{A}$		$V_R$	6	15	-	V
Junction capacitance	$V_R = 0\text{ V}$ , $f = 1\text{ MHz}$		$C_j$	-	50	-	pF

**Note**

- (1) In one packing unit  $I_{Vmin.}/I_{Vmax.} \leq 0.5$



LUMINOUS INTENSITY CLASSIFICATION		
GROUP	LIGHT INTENSITY (mcd)	
	STANDARD	
	MIN.	MAX.
L	1	2
M	1.6	3.2
N	2.5	5
P	4	8
Q	6.3	12.5
R	10	20
S	16	32

**Note**

- Luminous intensity is tested at a current pulse duration of 25 ms and an accuracy of  $\pm 11\%$ .  
These type numbers represent the order groups which include only a few brightness groups. Only one group will be shipped on each bag (there will be no mixing of two groups on each bag). In order to ensure availability, single brightness groups will not be orderable.  
In a similar manner for colors where wavelength groups are measured and binned, single wavelength groups will be shipped on any one bag.  
In order to ensure availability, single wavelength groups will not be orderable

GROUP	DOM. WAVELENGTH (nm)			
	YELLOW		GREEN	
	MIN.	MAX.	MIN.	MAX.
1	581	584	-	-
2	583	586	-	-
3	585	588	562	565
4	587	590	564	567
5	589	592	566	569
6	591	594	568	571
7	-	-	570	573
8	-	-	572	575

**Note**

- Wavelengths are tested at a current pulse duration of 25 ms

**TYPICAL CHARACTERISTICS** ( $T_{amb} = 25\text{ }^\circ\text{C}$ , unless otherwise specified)

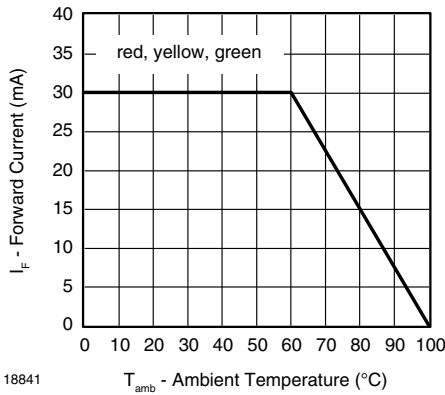

Fig. 1 - Forward Current vs. Ambient Temperature

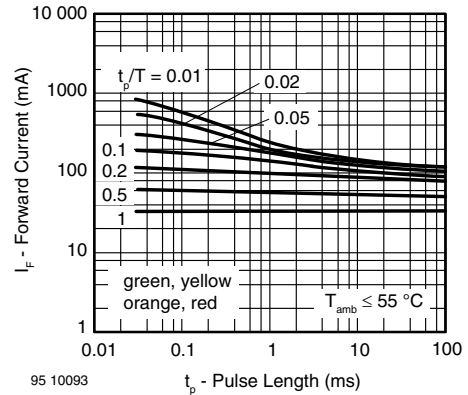

Fig. 2 - Forward Current vs. Pulse Length

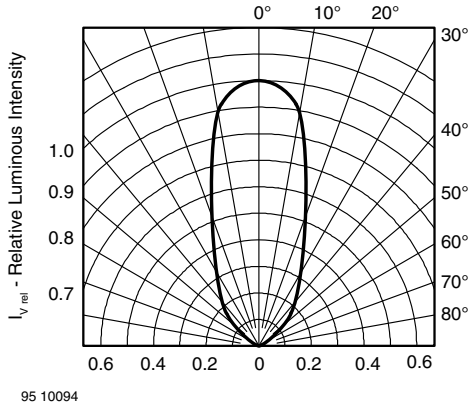

Fig. 3 - Relative Luminous Intensity vs. Angular Displacement

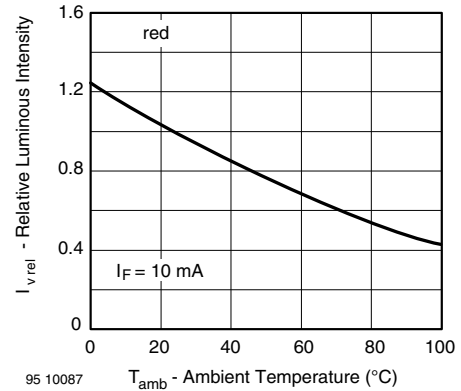

Fig. 6 - Relative Luminous Intensity vs. Ambient Temperature

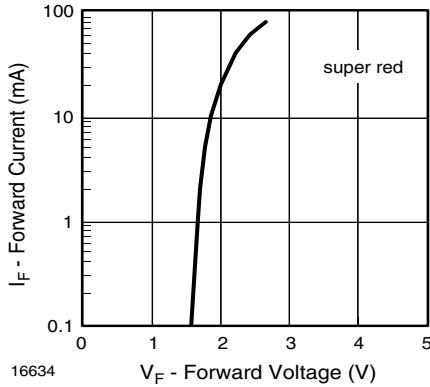

Fig. 4 - Forward Current vs. Forward Voltage

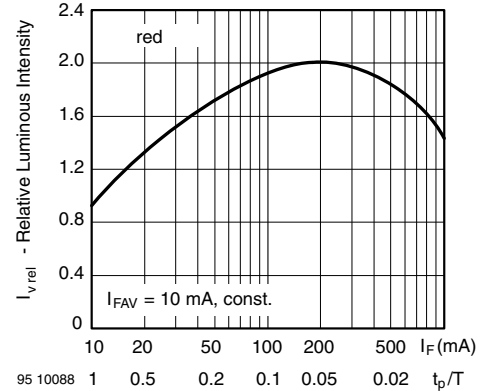

Fig. 7 - Relative Luminous Intensity vs. Forward Current/Duty Cycle

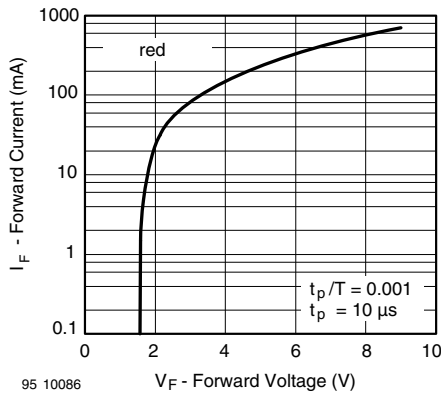

Fig. 5 - Forward Current vs. Forward Voltage

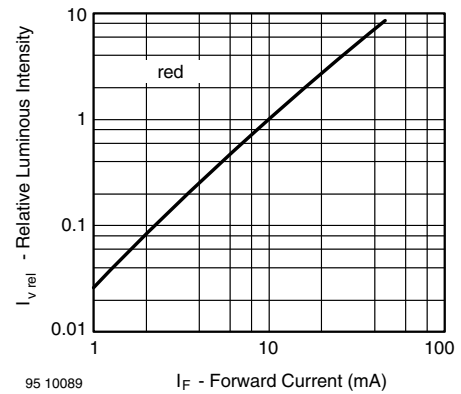

Fig. 8 - Relative Luminous Intensity vs. Forward Current

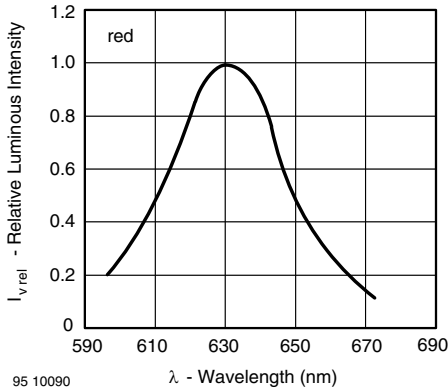

Fig. 9 - Relative Intensity vs. Wavelength

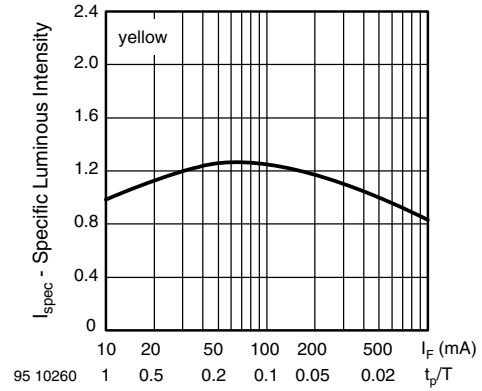

Fig. 12 - Relative Luminous Intensity vs. Forward Current/Duty Cycle

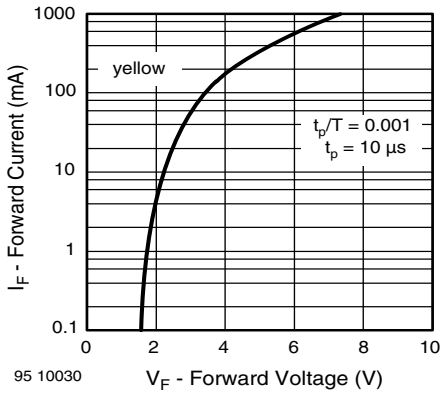

Fig. 10 - Forward Current vs. Forward Voltage

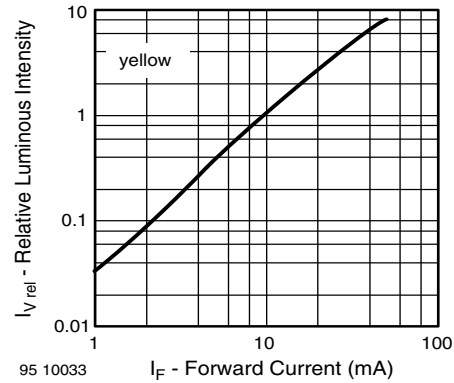

Fig. 13 - Relative Luminous Intensity vs. Forward Current

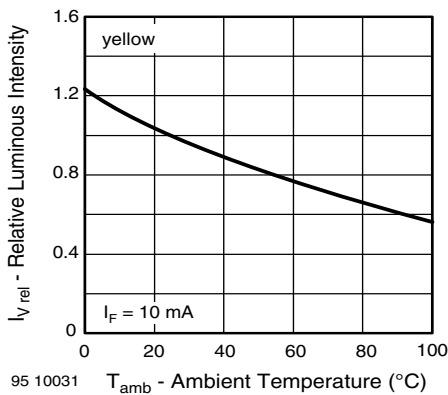

Fig. 11 - Relative Luminous Intensity vs. Ambient Temperature

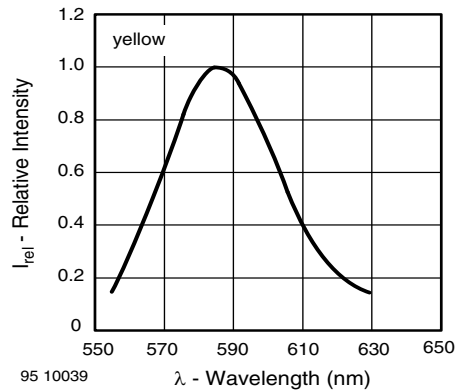

Fig. 14 - Relative Intensity vs. Wavelength

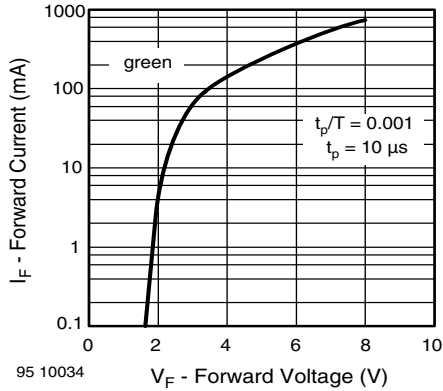

Fig. 15 - Forward Current vs. Forward Voltage

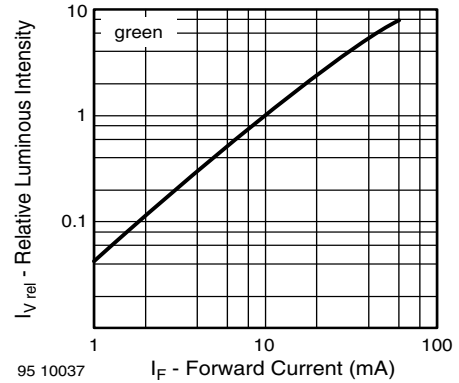

Fig. 18 - Relative Luminous Intensity vs. Forward Current

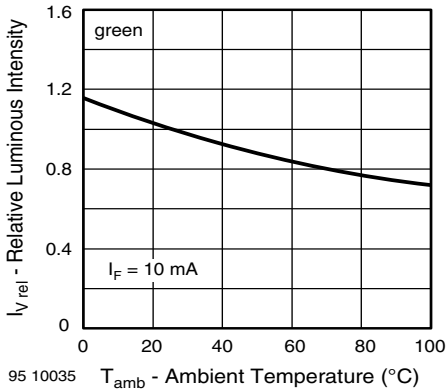

Fig. 16 - Relative Luminous Intensity vs. Ambient Temperature

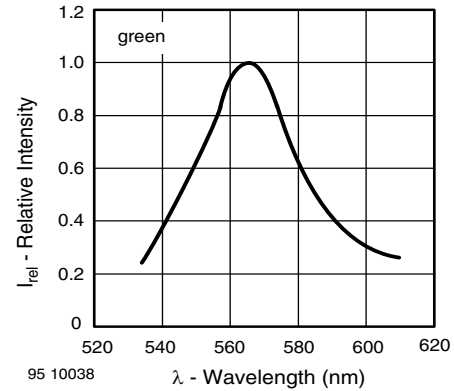

Fig. 19 - Relative Intensity vs. Wavelength

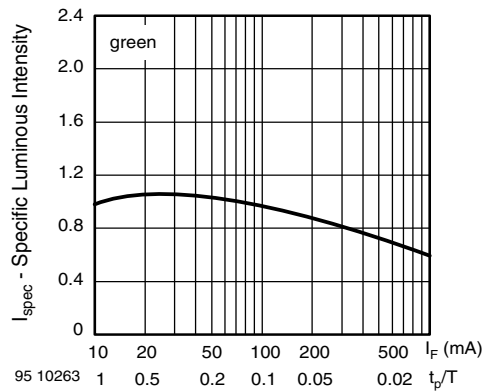
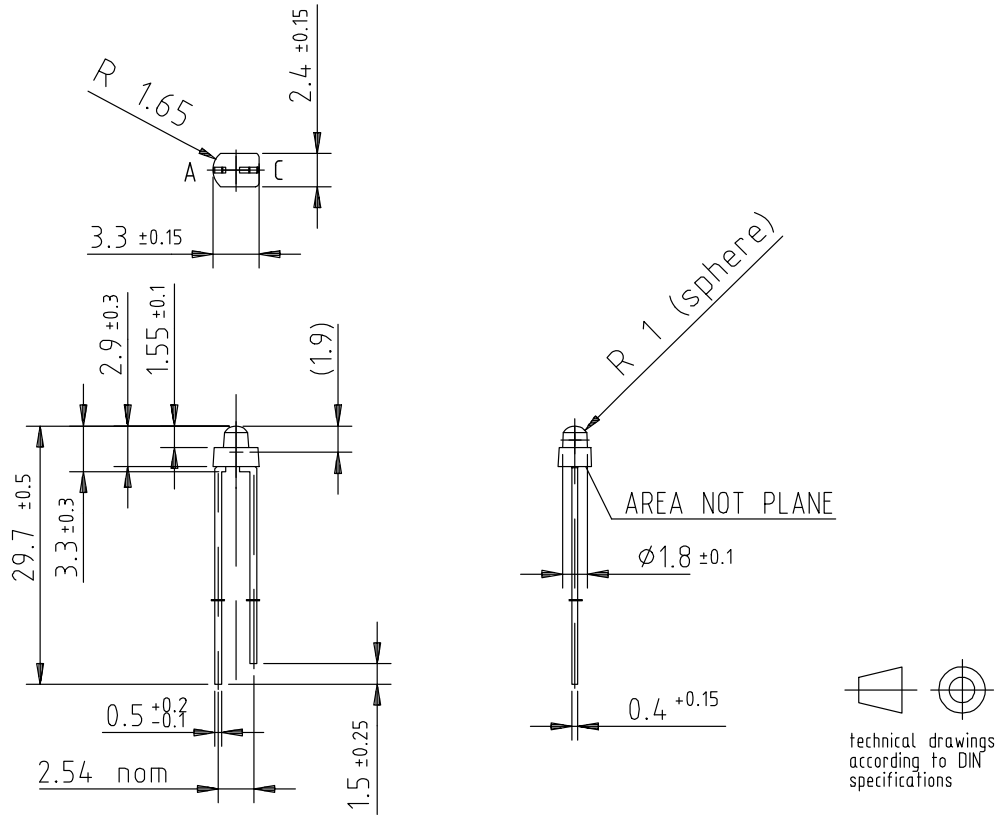

Fig. 17 - Specific Luminous Intensity vs. Forward Current



## PACKAGE DIMENSIONS in millimeters



Drawing-No.: 6.544-5052.01-4  
 Issue: 1; 12.10.95  
 95 11262

## REEL DIMENSIONS in millimeters

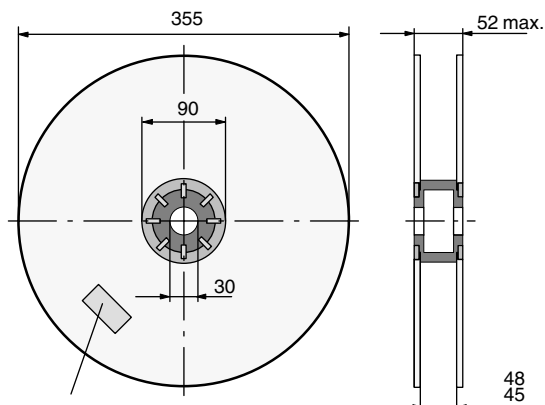

Identification label:  
 Vishay/type/group/tape code/production code/quantity

948641

Fig. 20 - Reel

## TAPE

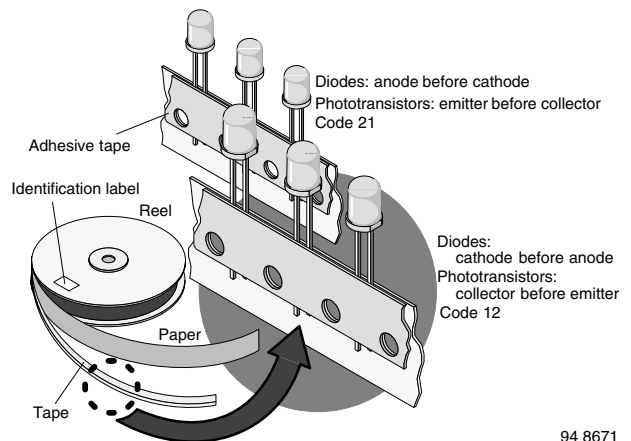

94 8671

Fig. 21 - LED in Tape



**TAPE DIMENSIONS** in millimeters

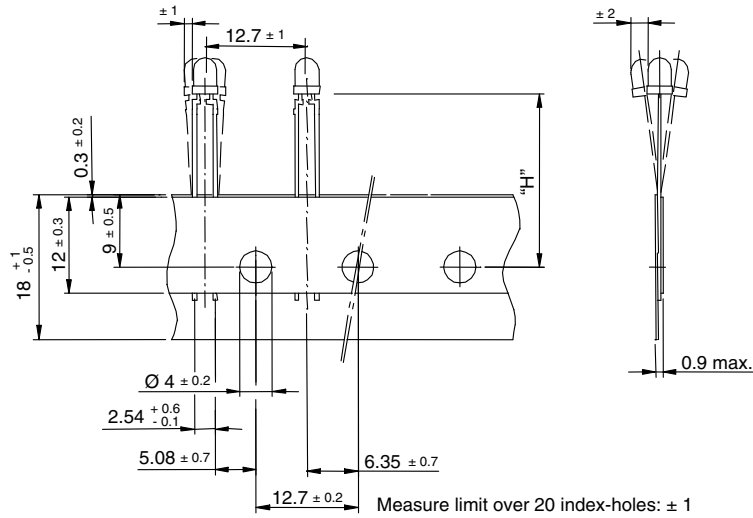

Quantity per:	Reel (Mat. - No. 1764)
	2000

94 8171

Option	Dim. "H" ± 0.5 mm
AS	17.3

<b>PACKING</b>	
Packing	Quantity
Tape and reel	5 x 2000
Bulk	1 x 5000





## Disclaimer

ALL PRODUCT, PRODUCT SPECIFICATIONS AND DATA ARE SUBJECT TO CHANGE WITHOUT NOTICE TO IMPROVE RELIABILITY, FUNCTION OR DESIGN OR OTHERWISE.

Vishay Intertechnology, Inc., its affiliates, agents, and employees, and all persons acting on its or their behalf (collectively, "Vishay"), disclaim any and all liability for any errors, inaccuracies or incompleteness contained in any datasheet or in any other disclosure relating to any product.

Vishay makes no warranty, representation or guarantee regarding the suitability of the products for any particular purpose or the continuing production of any product. To the maximum extent permitted by applicable law, Vishay disclaims (i) any and all liability arising out of the application or use of any product, (ii) any and all liability, including without limitation special, consequential or incidental damages, and (iii) any and all implied warranties, including warranties of fitness for particular purpose, non-infringement and merchantability.

Statements regarding the suitability of products for certain types of applications are based on Vishay's knowledge of typical requirements that are often placed on Vishay products in generic applications. Such statements are not binding statements about the suitability of products for a particular application. It is the customer's responsibility to validate that a particular product with the properties described in the product specification is suitable for use in a particular application. Parameters provided in datasheets and / or specifications may vary in different applications and performance may vary over time. All operating parameters, including typical parameters, must be validated for each customer application by the customer's technical experts. Product specifications do not expand or otherwise modify Vishay's terms and conditions of purchase, including but not limited to the warranty expressed therein.

Hyperlinks included in this datasheet may direct users to third-party websites. These links are provided as a convenience and for informational purposes only. Inclusion of these hyperlinks does not constitute an endorsement or an approval by Vishay of any of the products, services or opinions of the corporation, organization or individual associated with the third-party website. Vishay disclaims any and all liability and bears no responsibility for the accuracy, legality or content of the third-party website or for that of subsequent links.

Except as expressly indicated in writing, Vishay products are not designed for use in medical, life-saving, or life-sustaining applications or for any other application in which the failure of the Vishay product could result in personal injury or death. Customers using or selling Vishay products not expressly indicated for use in such applications do so at their own risk. Please contact authorized Vishay personnel to obtain written terms and conditions regarding products designed for such applications.

No license, express or implied, by estoppel or otherwise, to any intellectual property rights is granted by this document or by any conduct of Vishay. Product names and markings noted herein may be trademarks of their respective owners.