

D type

V series

Features

- Large withstanding surge current capability in compact sizes
- Large "Energy Handling Capability" absorbing transient overvoltages in compact sizes
- Wide range of varistor voltages
- RoHS compliant

Recommended applications

- Transistor, diode, IC, thyristor or triac semiconductor protection
- Surge protection in consumer electronic equipment
- Surge protection in communication, measuring or controller electronics
- Surge protection in electronic home appliances, gas or petroleum appliances

Applicable standards

- UL1449 (VZCA2/UL, VZCA8/C-UL)
- VDE IEC61051-1, -2, -2-2, IEC60950-1 Annex.Q, IEC62368-1 G8.2
- CSA C22.2 N 269.5
- CQC (GB/T10193, GB/T10194, GB4943.1, GB8898)

Refer to "Standard Products" , and "Application Note for Safety Standards" , for the details.

■ As for handling precautions and minimum quantity / packing unit, please see related information

Explanation of part numbers (Bulk)

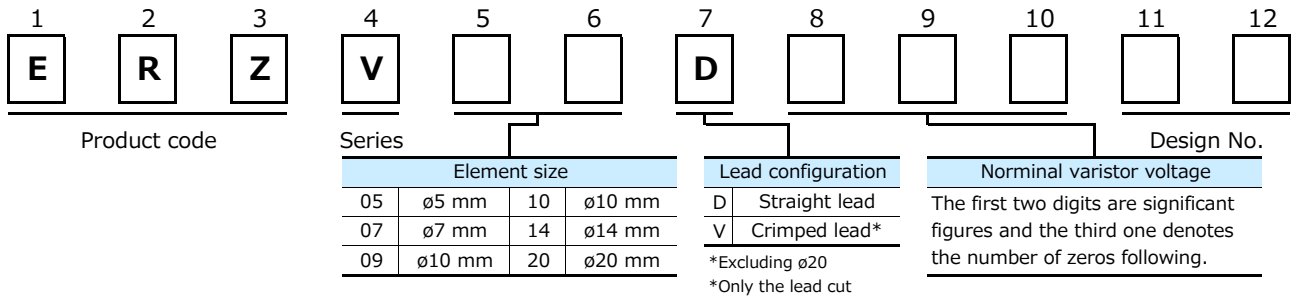

Explanation of part numbers (Taping)

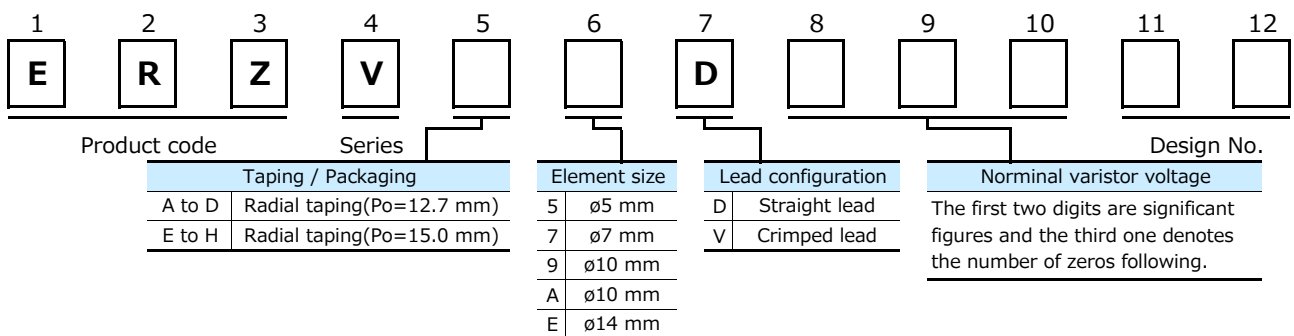

Reference guide to standard products

Part No.	Applicable standards		Varistor voltage* (V)	Maximum allowable voltage		Clamping voltage at 8/20 μs		Maximum Peak current at 8/20 μs (A)	
	Type name	Approvals		AC rms (V)	DC (V)	max.(V)	Ip(A)	1 time	2 times
ERZV05D180	V180	◇	18 (16 to 20)	11	14	40	1	250	125
ERZV07D180	V7180	◇				36	2.5	500	250
ERZV09D180	V9180	◇				36	5	1000	500
ERZV10D180	V10180	◇				36	5	1000	500
ERZV14D180	V14180	◇				36	10	2000	1000
ERZV20D180	V20180	◇				36	20	3000	2000
ERZV05D220	V220	◇	22 (20 to 24)	14	18	48	1	250	125
ERZV07D220	V7220	◇				43	2.5	500	250
ERZV09D220	V9220	◇				43	5	1000	500
ERZV10D220	V10220	◇				43	5	1000	500
ERZV14D220	V14220	◇				43	10	2000	1000
ERZV20D220	V20220	◇				43	20	3000	2000
ERZV05D270	V270	◇	27 (24 to 30)	17	22	60	1	250	125
ERZV07D270	V7270	◇				53	2.5	500	250
ERZV09D270	V9270	◇				53	5	1000	500
ERZV10D270	V10270	◇				53	5	1000	500
ERZV14D270	V14270	◇				53	10	2000	1000
ERZV20D270	V20270	◇				53	20	3000	2000
ERZV05D330	V330	◇	33 (30 to 36)	20	26	73	1	250	125
ERZV07D330	V7330	◇				65	2.5	500	250
ERZV09D330	V9330	◇				65	5	1000	500
ERZV10D330	V10330	◇				65	5	1000	500
ERZV14D330	V14330	◇				65	10	2000	1000
ERZV20D330	V20330	◇				65	20	3000	2000
ERZV05D390	V390	◇	39 (35 to 43)	25	31	86	1	250	125
ERZV07D390	V7390	◇				77	2.5	500	250
ERZV09D390	V9390	◇				77	5	1000	500
ERZV10D390	V10390	◇				77	5	1000	500
ERZV14D390	V14390	◇				77	10	2000	1000
ERZV20D390	V20390	◇				77	20	3000	2000
ERZV05D470	V470	◇	47 (42 to 52)	30	38	104	1	250	125
ERZV07D470	V7470	◇				93	2.5	500	250
ERZV09D470	V9470	◇				93	5	1000	500
ERZV10D470	V10470	◇				93	5	1000	500
ERZV14D470	V14470	◇				93	10	2000	1000
ERZV20D470	V20470	◇				93	20	3000	2000
ERZV05D560	V560	◇	56 (50 to 62)	35	45	123	1	250	125
ERZV07D560	V7560	◇				110	2.5	500	250
ERZV09D560	V9560	◇				110	5	1000	500
ERZV10D560	V10560	◇				110	5	1000	500
ERZV14D560	V14560	◇				110	10	2000	1000
ERZV20D560	V20560	◇				110	20	3000	2000
ERZV05D680	V680	◇	68 (61 to 75)	40	56	150	1	250	125
ERZV07D680	V7680	◇				135	2.5	500	250
ERZV09D680	V9680	◇				135	5	1000	500
ERZV10D680	V10680	◇				135	5	1000	500
ERZV14D680	V14680	◇				135	10	2000	1000
ERZV20D680	V20680	◇				135	20	3000	2000

* Measuring Current of Varistor Voltage 5 Series (ERZV05D □□□) : 0.1 mA, Others : 1 mA

○: UL1449 (VZCA2/UL, VZCA8/C-UL),

☆: VDE (IEC61051-1, -2, -2-2), ★ : VDE (IEC60950-1 Annex.Q, IEC62368-1 G8.2), □ : CSA C22.2 No.269.5

◇: CQC (GB/T10193, GB/T10194), ◆ : CQC (GB4943.1, GB8898)

※Approval number (File No.) of safety regulations are subject to revision without notice. Ask factory for a copy of the latest file No.

Reference guide to standard products

Part No.	Applicable standards		Varistor voltage* (V)	Maximum allowable voltage		Clamping voltage at 8/20 μs		Maximum peak current at 8/20 μs (A)	
	Type name	Approvals		AC rms (V)	DC (V)	max.(V)	I _p (A)	1 time	2 times
ERZV05D820	V820U	○☆◇	82 (74 to 90)	50	65	145	5	800	600
ERZV07D820	V7820U	○☆◇				135	10	1750	1250
ERZV09D820	V9820U	○☆◇				135	25	3500	2500
ERZV10D820	V10820U	○☆◇				135	25	3500	2500
ERZV14D820	V14820U	○☆◇				135	50	6000	5000
ERZV20D820	V20820U	○☆◇				135	100	10000	7000
ERZV05D101	V101U	○☆◇	100 (90 to 110)	60	85	175	5	800	600
ERZV07D101	V7101U	○☆◇				165	10	1750	1250
ERZV09D101	V9101U	○☆◇				165	25	3500	2500
ERZV10D101	V10101U	○☆◇				165	25	3500	2500
ERZV14D101	V14101U	○☆◇				165	50	6000	5000
ERZV20D101	V20101U	○☆◇				165	100	10000	7000
ERZV05D121	V121U	○☆◇	120 (108 to 132)	75	100	210	5	800	600
ERZV07D121	V7121U	○☆◇				200	10	1750	1250
ERZV09D121	V9121U	○☆◇				200	25	3500	2500
ERZV10D121	V10121U	○☆◇				200	25	3500	2500
ERZV14D121	V14121U	○☆◇				200	50	6000	5000
ERZV20D121	V20121U	○☆◇				200	100	10000	7000
ERZV05D151	V151U	○☆◇	150 (135 to 165)	95	125	260	5	800	600
ERZV07D151	V7151U	○☆◇				250	10	1750	1250
ERZV09D151	V9151U	○☆◇				250	25	3500	2500
ERZV10D151	V10151U	○☆◇				250	25	3500	2500
ERZV14D151	V14151U	○☆◇				250	50	6000	5000
ERZV20D151	V20151U	○☆◇				250	100	10000	7000
ERZV05D201	V201U	○☆□◇	200 (185 to 225)	130	170	355	5	800	600
ERZV07D201	V7201U	○☆□◇				340	10	1750	1250
ERZV09D201	V9201U	○☆□◇				340	25	3500	2500
ERZV10D201	V10201U	○☆□◇				340	25	3500	2500
ERZV14D201	V14201U	○☆★□◇◆				340	50	6000	5000
ERZV20D201	V20201U	○☆★□◇◆				340	100	10000	7000
ERZV05D221	V221U	○☆□◇	220 (198 to 242)	140	180	380	5	800	600
ERZV07D221	V7221U	○☆□◇				360	10	1750	1250
ERZV09D221	V9221U	○☆□◇				360	25	3500	2500
ERZV10D221	V10221U	○☆□◇				360	25	3500	2500
ERZV14D221	V14221U	○☆★□◇◆				360	50	6000	5000
ERZV20D221	V20221U	○☆★□◇◆				360	100	10000	7000
ERZV05D241	V241U	○☆□◇	240 (216 to 264)	150	200	415	5	800	600
ERZV07D241	V7241U	○☆□◇				395	10	1750	1250
ERZV09D241	V9241U	○☆□◇				395	25	3500	2500
ERZV10D241	V10241U	○☆□◇				395	25	3500	2500
ERZV14D241	V14241U	○☆★□◇◆				395	50	6000	5000
ERZV20D241	V20241U	○☆★□◇◆				395	100	10000	7000
ERZV05D271	V271U	○☆□◇	270 (247 to 303)	175	225	475	5	800	600
ERZV07D271	V7271U	○☆□◇				455	10	1750	1250
ERZV09D271	V9271U	○☆□◇				455	25	3500	2500
ERZV10D271	V10271U	○☆□◇				455	25	3500	2500
ERZV14D271	V14271U	○☆★□◇◆				455	50	6000	5000
ERZV20D271	V20271U	○☆★□◇◆				455	100	10000	7000

* Measuring Current of Varistor Voltage 5 Series (ERZV05D □□□) : 0.1 mA, Others : 1 mA

○: UL1449 (VZCA2/UL, VZCA8/C-UL),

☆: VDE (IEC61051-1, -2, -2-2), ★: VDE (IEC60950-1 Annex.Q, IEC62368-1 G8.2), □: CSA C22.2 No.269.5

◇: CQC (GB/T10193, GB/T10194), ◆: CQC (GB4943.1, GB8898)

※Approval number (File No.) of safety regulations are subject to revision without notice. Ask factory for a copy of the latest file No.

Reference guide to standard products

Part No.	Applicable standards		Varistor voltage* (V)	Maximum allowable voltage		Clamping voltage at 8/20 μs		Maximum peak current at 8/20 μs (A)	
	Type name	Approvals		AC rms (V)	DC (V)	max.(V)	I _p (A)	1 time	2 times
ERZV05D331	V331U	○☆□◇	330 (297 to 363)	210	270	570	5	800	600
ERZV07D331	V7331U	○☆□◇				545	10	1750	1250
ERZV09D331	V9331U	○☆□◇				545	25	3500	2500
ERZV10D331	V10331U	○☆□◇				545	25	3500	2500
ERZV14D331	V14331U	○☆★□◇◆				545	50	6000	4500
ERZV20D331	V20331U	○☆★□◇◆				545	100	10000	6500
ERZV05D361	V361U	○☆□◇	360 (324 to 396)	230	300	620	5	800	600
ERZV07D361	V7361U	○☆□◇				595	10	1750	1250
ERZV09D361	V9361U	○☆□◇				595	25	3500	2500
ERZV10D361	V10361U	○☆□◇				595	25	3500	2500
ERZV14D361	V14361U	○☆★□◇◆				595	50	6000	4500
ERZV20D361	V20361U	○☆★□◇◆				595	100	10000	6500
ERZV05D391	V391U	○☆□◇	390 (351 to 429)	250	320	675	5	800	600
ERZV07D391	V7391U	○☆□◇				650	10	1750	1250
ERZV09D391	V9391U	○☆□◇				650	25	3500	2500
ERZV10D391	V10391U	○☆□◇				650	25	3500	2500
ERZV14D391	V14391U	○☆★□◇◆				650	50	6000	4500
ERZV20D391	V20391U	○☆★□◇◆				650	100	10000	6500
ERZV05D431	V431U	○☆□◇	430 (387 to 473)	275	350	745	5	800	600
ERZV07D431	V7431U	○☆□◇				710	10	1750	1250
ERZV09D431	V9431U	○☆□◇				710	25	3500	2500
ERZV10D431	V10431U	○☆□◇				710	25	3500	2500
ERZV14D431	V14431U	○☆★□◇◆				710	50	6000	4500
ERZV20D431	V20431U	○☆★□◇◆				710	100	10000	6500
ERZV05D471	V471U	○☆□◇	470 (423 to 517)	300	385	810	5	800	600
ERZV07D471	V7471U	○☆□◇				775	10	1750	1250
ERZV09D471	V9471U	○☆□◇				775	25	3500	2500
ERZV10D471	V10471U	○☆★□◇◆				775	25	3500	2500
ERZV14D471	V14471U	○☆★□◇◆				775	50	6000	4500
ERZV20D471	V20471U	○☆★□◇◆				775	100	10000	6500
ERZV07D511	V7511U	○☆□◇	510 (459 to 561)	320	410	845	10	1750	1250
ERZV09D511	V9511U	○☆□◇				845	25	3500	2500
ERZV10D511	V10511U	○☆★□◇◆				845	25	3500	2500
ERZV14D511	V14511U	○☆★□◇◆				845	50	6000	4500
ERZV20D511	V20511U	○☆★□◇◆				845	100	10000	6500
ERZV10D561	V10561U	○☆★□◇◆				560 (504 to 616)	350	450	930
ERZV14D561	V14561U	○☆★□◇◆	930	50	5000				4500
ERZV20D561	V20561U	○☆★□◇◆	930	100	7500				6500
ERZV10D621	V10621U	○☆★□◇◆	620 (558 to 682)	385	505	1025	25	3500	2500
ERZV14D621	V14621U	○☆★□◇◆				1025	50	5000	4500
ERZV20D621	V20621U	○☆★□◇◆				1025	100	7500	6500
ERZV10D681	V10681U	○☆★□◇◆	680 (612 to 748)	420	560	1120	25	3500	2500
ERZV14D681	V14681U	○☆★□◇◆				1120	50	5000	4500
ERZV20D681	V20681U	○☆★□◇◆				1120	100	7500	6500

* Measuring Current of Varistor Voltage 5 Series (ERZV05D □□□) : 0.1 mA, Others : 1 mA

○: UL1449 (VZCA2/UL, VZCA8/C-UL),

☆: VDE (IEC61051-1, -2, -2-2), ★ : VDE (IEC60950-1 Annex.Q, IEC62368-1 G8.2), □ : CSA C22.2 No.269.5

◇: CQC (GB/T10193, GB/T10194), ◆ : CQC (GB4943.1, GB8898)

※Approval number (File No.) of safety regulations are subject to revision without notice. Ask factory for a copy of the latest file No.

Reference guide to standard products

Part No.	Applicable standards		Varistor voltage* (V)	Maximum allowable voltage		Clamping voltage 8/20 μs		Maximum peak current at 8/20 μs (A)	
	Type name	Approvals		AC rms (V)	DC (V)	max.(V)	I _p (A)	1 time	2 times
ERZV10D751	V10751U	○☆★□◇◆	750 (675 to 825)	460	615	1240	25	3500	2500
ERZV14D751	V14751U	○☆★□◇◆				1240	50	5000	4500
ERZV20D751	V20751U	○☆★□◇◆				1240	100	7500	6500
ERZV10D821	V10821U	○☆★□◇◆	820 (738 to 902)	510	670	1355	25	3500	2500
ERZV14D821	V14821U	○☆★□◇◆				1355	50	5000	4500
ERZV20D821	V20821U	○☆★□◇◆				1355	100	7500	6500
ERZV10D911	V10911U	○☆★□◇◆	910 (819 to 1001)	550	745	1500	25	3500	2500
ERZV14D911	V14911U	○☆★□◇◆				1500	50	5000	4500
ERZV20D911	V20911U	○☆★□◇◆				1500	100	7500	6500
ERZV10D102	V10102U	○☆★□◇◆	1000 (900 to 1100)	625	825	1650	25	3500	2500
ERZV14D102	V14102U	○☆★□◇◆				1650	50	5000	4500
ERZV20D102	V20102U	○☆★□◇◆				1650	100	7500	6500
ERZV10D112	V10112U	○☆★□◇◆	1100 (990 to 1210)	680	895	1815	25	3500	2500
ERZV14D112	V14112U	○☆★□◇◆				1815	50	5000	4500
ERZV20D112	V20112U	○☆★□◇◆				1815	100	7500	6500
ERZV10D182CS	V10182U	○☆★□◇◆	1800 (1700 to 1980)	1000	1465	2970	25	3500	2500
ERZV14D182CS	V14182U	○☆★□◇◆				2970	50	5000	4500
ERZV20D182	V20182U	○☆★□◇◆				2970	100	7500	6500

* Measuring Current of Varistor Voltage 5 Series (ERZV05D □□□) : 0.1 mA, Others : 1 mA

○: UL1449 (VZCA2/UL, VZCA8/C-UL),

☆: VDE (IEC61051-1, -2, -2-2), ★ : VDE (IEC60950-1 Annex.Q, IEC62368-1 G8.2), □ : CSA C22.2 No.269.5

◇: CQC (GB/T10193, GB/T10194), ◆ : CQC (GB4943.1, GB8898)

※Approval number (File No.) of safety regulations are subject to revision without notice. Ask factory for a copy of the latest file No.

5 Series

Ratings and characteristics

● Operating Temperature Range : -40 to 85 °C ● Storage Temperature Range : -40 to 125 °C

Part No.	Varistor voltage $V_{0.1\text{mA}}$ (V)	Maximum allowable voltage		Clamping voltage (max.) **I _p (V)	Rated power (W)	Maximum energy		Maximum peak current (8/20 μs)		Capacitance (max.) at 1 kHz (pF)
		AC rms (V)	DC (V)			(10/1000 μs) (J)	(2 ms) (J)	1 time (A)	2 times (A)	
ERZV05D180	18(16 to 20)	11	14	40	0.01	0.6	0.4	250	125	1600
ERZV05D220	22(20 to 24)	14	18	48	0.01	0.7	0.5	250	125	1500
ERZV05D270	27(24 to 30)	17	22	60	0.01	0.9	0.7	250	125	1450
ERZV05D330	33(30 to 36)	20	26	73	0.01	1.1	0.8	250	125	1400
ERZV05D390	39(35 to 43)	25	31	86	0.01	1.2	0.9	250	125	700
ERZV05D470	47(42 to 52)	30	38	104	0.01	1.5	1.1	250	125	650
ERZV05D560	56(50 to 62)	35	45	123	0.01	1.8	1.3	250	125	600
ERZV05D680	68(61 to 75)	40	56	150	0.01	2.2	1.6	250	125	580
ERZV05D820	82(74 to 90)	50	65	145	0.1	3.5	2.5	800	600	460
ERZV05D101	100(90 to 110)	60	85	175	0.1	4.0	3.0	800	600	400
ERZV05D121	120(108 to 132)	75	100	210	0.1	5.0	3.5	800	600	350
ERZV05D151	150(135 to 165)	95	125	260	0.1	6.5	4.5	800	600	300
ERZV05D201	200(185 to 225)	130	170	355	0.1	8.5	6.0	800	600	120
ERZV05D221	220(198 to 242)	140	180	380	0.1	9.0	6.5	800	600	110
ERZV05D241	240(216 to 264)	150	200	415	0.1	10.5	7.5	800	600	100
ERZV05D271	270(247 to 303)	175	225	475	0.1	11.0	8.0	800	600	90*
ERZV05D331	330(297 to 363)	210	270	570	0.1	13.0	9.5	800	600	80*
ERZV05D361	360(324 to 396)	230	300	620	0.1	16.0	11.0	800	600	80*
ERZV05D391	390(351 to 429)	250	320	675	0.1	17.0	12.0	800	600	80*
ERZV05D431	430(387 to 473)	275	350	745	0.1	20.0	13.5	800	600	70*
ERZV05D471	470(423 to 517)	300	385	810	0.1	21.0	15.0	800	600	60*

*Measured at 1 MHz **I_p Measuring current of clamping voltage 180 to 680 : 1 A, 820 to 471 : 5 A

Dimensions in mm (not to scale)

Unit : mm

Part No.	D max.	T max.	W±1.0	H max.	L±1.0
ERZV05D180	7.0	4.5	5.0	10.0	1.5
ERZV05D220	7.0	4.5	5.0	10.0	1.5
ERZV05D270	7.0	4.5	5.0	10.0	1.5
ERZV05D330	7.0	4.5	5.0	10.0	1.5
ERZV05D390	7.0	4.5	5.0	10.0	1.5
ERZV05D470	7.0	4.5	5.0	10.0	1.5
ERZV05D560	7.0	4.5	5.0	10.0	1.5
ERZV05D680	7.0	4.5	5.0	10.0	1.5
ERZV05D820	7.0	4.1	5.0	10.0	1.4
ERZV05D101	7.0	4.3	5.0	10.0	1.6
ERZV05D121	7.0	4.5	5.0	10.0	1.8
ERZV05D151	7.0	4.8	5.0	10.0	2.1
ERZV05D201	7.0	4.4	5.0	10.0	1.7
ERZV05D221	7.0	4.5	5.0	10.0	1.8
ERZV05D241	7.0	4.6	5.0	10.0	1.9
ERZV05D271	7.0	4.8	5.0	10.0	2.1
ERZV05D331	7.0	5.1	5.0	10.0	2.4
ERZV05D361	7.0	5.3	5.0	10.0	2.5
ERZV05D391	7.0	5.4	5.0	10.0	2.7
ERZV05D431	7.0	5.6	5.0	10.0	2.9
ERZV05D471	7.0	5.8	5.0	10.0	3.1

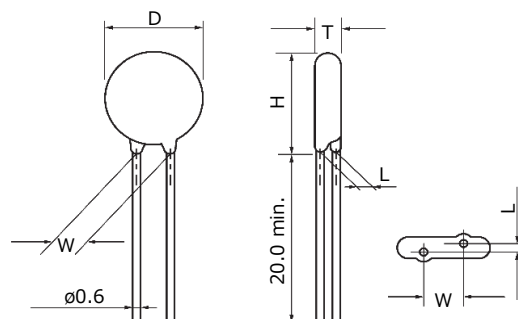

Typical Characteristics

Voltage vs. Current

ERZV05D180 to ERZV05D680

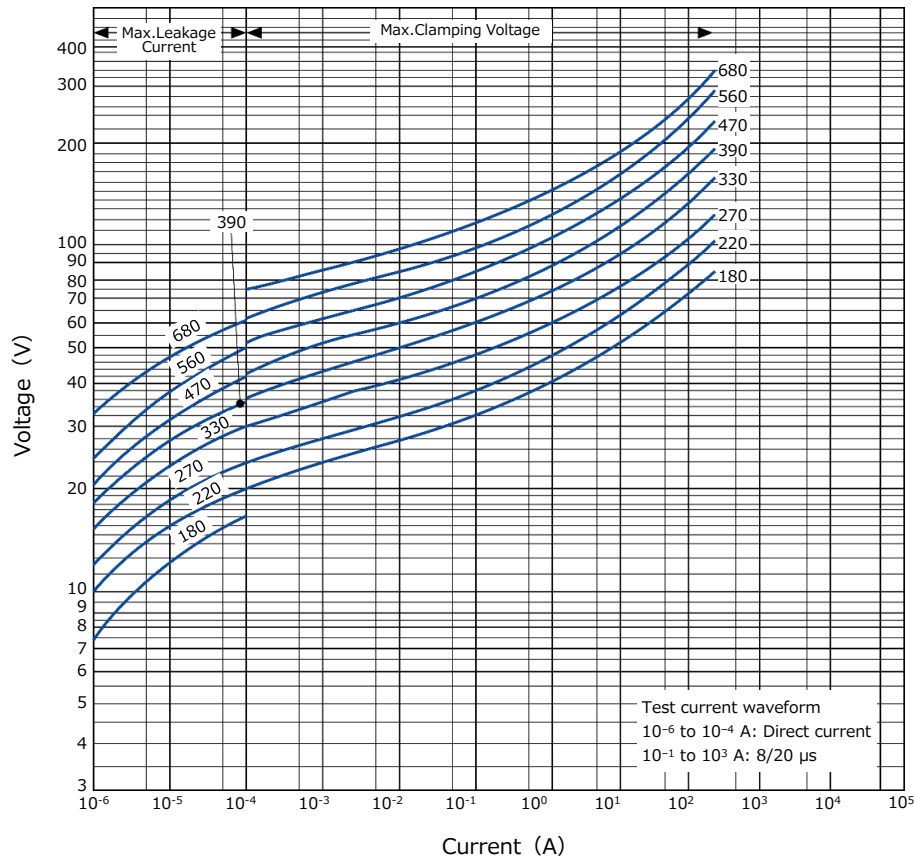

Impulse Derating (Relation between impulse width and impulse current multiple)

ERZV05D180 to ERZV05D680

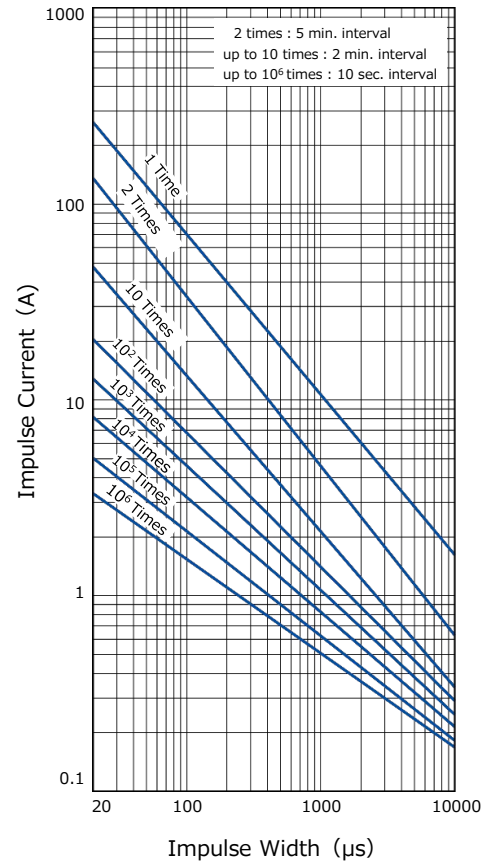

ERZV05D820 to ERZV05D471

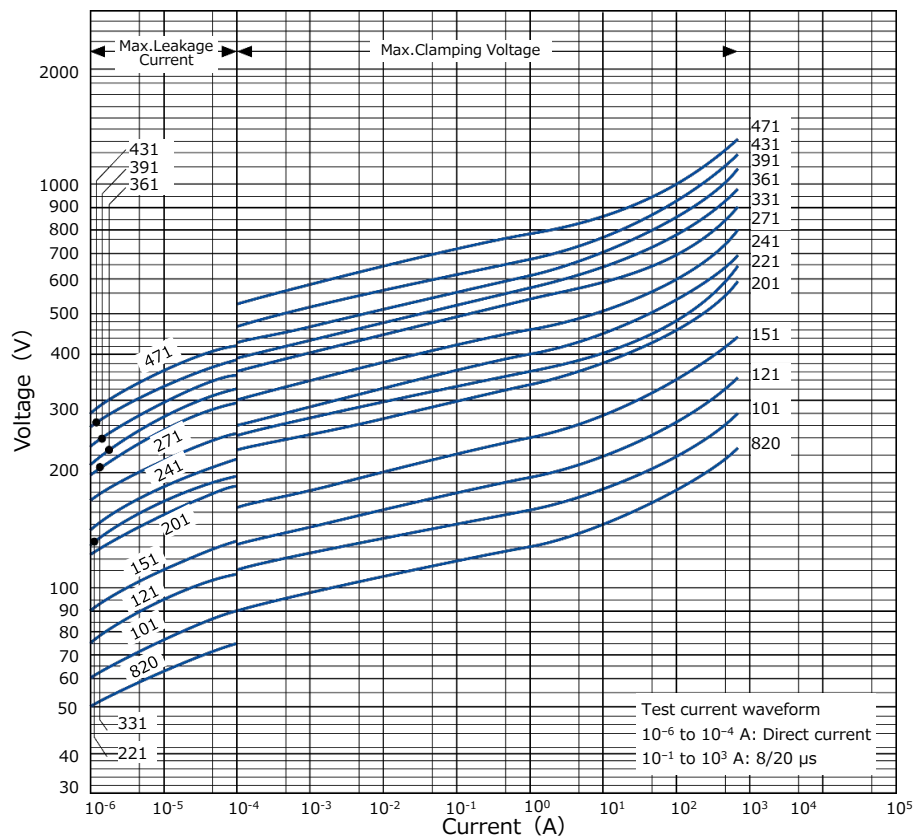

ERZV05D820 to ERZV05D471

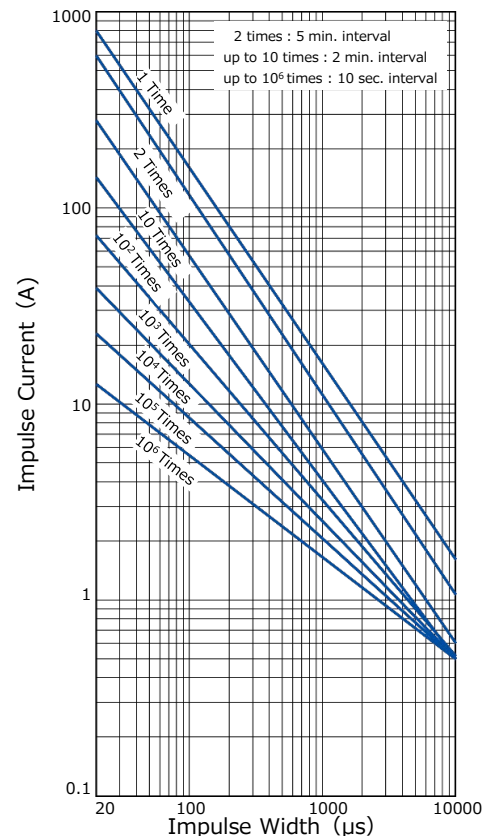

7 Series

Ratings and characteristics

● Operating Temperature Range : -40 to 85 °C ● Storage Temperature Range : -40 to 125 °C

Part No.	Varistor voltage $V_{1mA}(V)$	Maximum allowable voltage		Clamping voltage (max.) **Ip (V)	Rated power (W)	Maximum energy		Maximum peak current (8/20 μ s)		Capacitance (max.) at 1 kHz (pF)
		AC rms (V)	DC (V)			(10/1000 μ s) (J)	(2 ms) (J)	1 time (A)	2 times (A)	
ERZV07D180	18(16 to 20)	11	14	36	0.02	1.1	0.9	500	250	3800
ERZV07D220	22(20 to 24)	14	18	43	0.02	1.3	1.1	500	250	3600
ERZV07D270	27(24 to 30)	17	22	53	0.02	1.6	1.3	500	250	3400
ERZV07D330	33(30 to 36)	20	26	65	0.02	2.0	1.6	500	250	2900
ERZV07D390	39(35 to 43)	25	31	77	0.02	2.4	1.9	500	250	1600
ERZV07D470	47(42 to 52)	30	38	93	0.02	2.8	2.3	500	250	1550
ERZV07D560	56(50 to 62)	35	45	110	0.02	3.4	2.7	500	250	1500
ERZV07D680	68(61 to 75)	40	56	135	0.02	4.1	3.3	500	250	1200
ERZV07D820	82(74 to 90)	50	65	135	0.25	7	5	1750	1250	810
ERZV07D101	100(90 to 110)	60	85	165	0.25	8.5	6	1750	1250	700
ERZV07D121	120(108 to 132)	75	100	200	0.25	10	7	1750	1250	590
ERZV07D151	150(135 to 165)	95	125	250	0.25	13	9	1750	1250	500
ERZV07D201	200(185 to 225)	130	170	340	0.25	17.5	12.5	1750	1250	200
ERZV07D221	220(198 to 242)	140	180	360	0.25	19	13.5	1750	1250	190
ERZV07D241	240(216 to 264)	150	200	395	0.25	21	15	1750	1250	170
ERZV07D271	270(247 to 303)	175	225	455	0.25	24	17	1750	1250	150
ERZV07D331	330(297 to 363)	210	270	545	0.25	28	20	1750	1250	130
ERZV07D361	360(324 to 396)	230	300	595	0.25	32	23	1750	1250	130
ERZV07D391	390(351 to 429)	250	320	650	0.25	35	25	1750	1250	130
ERZV07D431	430(387 to 473)	275	350	710	0.25	40	27.5	1750	1250	120
ERZV07D471	470(423 to 517)	300	385	775	0.25	42	30	1750	1250	100
ERZV07D511	510(459 to 561)	320	410	845	0.25	45	32	1750	1250	90*

*Measured at 1 MHz **Ip Measuring current of clamping voltage 180 to 680 : 2.5 A, 820 to 511 : 10 A

Dimensions in mm (not to scale)

Unit : mm

Part No.	D max.	T max.	W \pm 1.0	H max.	L \pm 1.0
ERZV07D180	8.5	4.5	5.0	11.5	1.3
ERZV07D220	8.5	4.6	5.0	11.5	1.4
ERZV07D270	8.5	4.7	5.0	11.5	1.5
ERZV07D330	8.5	4.9	5.0	11.5	1.7
ERZV07D390	8.5	4.8	5.0	11.5	1.6
ERZV07D470	8.5	4.9	5.0	11.5	1.7
ERZV07D560	8.5	5.0	5.0	11.5	1.8
ERZV07D680	8.5	5.2	5.0	11.5	2.0
ERZV07D820	8.5	4.1	5.0	11.5	1.4
ERZV07D101	8.5	4.3	5.0	11.5	1.6
ERZV07D121	8.5	4.5	5.0	11.5	1.8
ERZV07D151	8.5	4.8	5.0	11.5	2.1
ERZV07D201	8.5	4.4	5.0	11.5	1.7
ERZV07D221	8.5	4.5	5.0	11.5	1.8
ERZV07D241	8.5	4.6	5.0	11.5	1.9
ERZV07D271	8.5	4.8	5.0	11.5	2.1
ERZV07D331	8.5	5.1	5.0	11.5	2.4
ERZV07D361	8.5	5.3	5.0	11.5	2.5
ERZV07D391	8.5	5.4	5.0	11.5	2.7
ERZV07D431	8.5	5.6	5.0	11.5	2.9
ERZV07D471	8.5	5.8	5.0	11.5	3.1
ERZV07D511	8.5	6.0	5.0	11.5	3.3

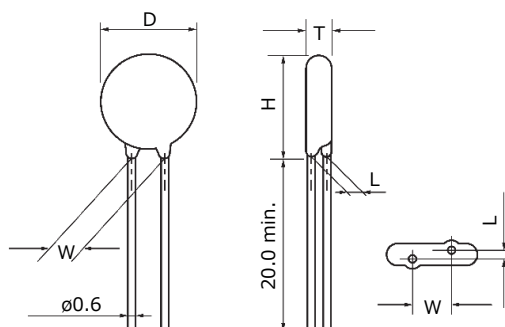

Typical Characteristics

Voltage vs. Current

ERZV07D180 to ERZV07D680

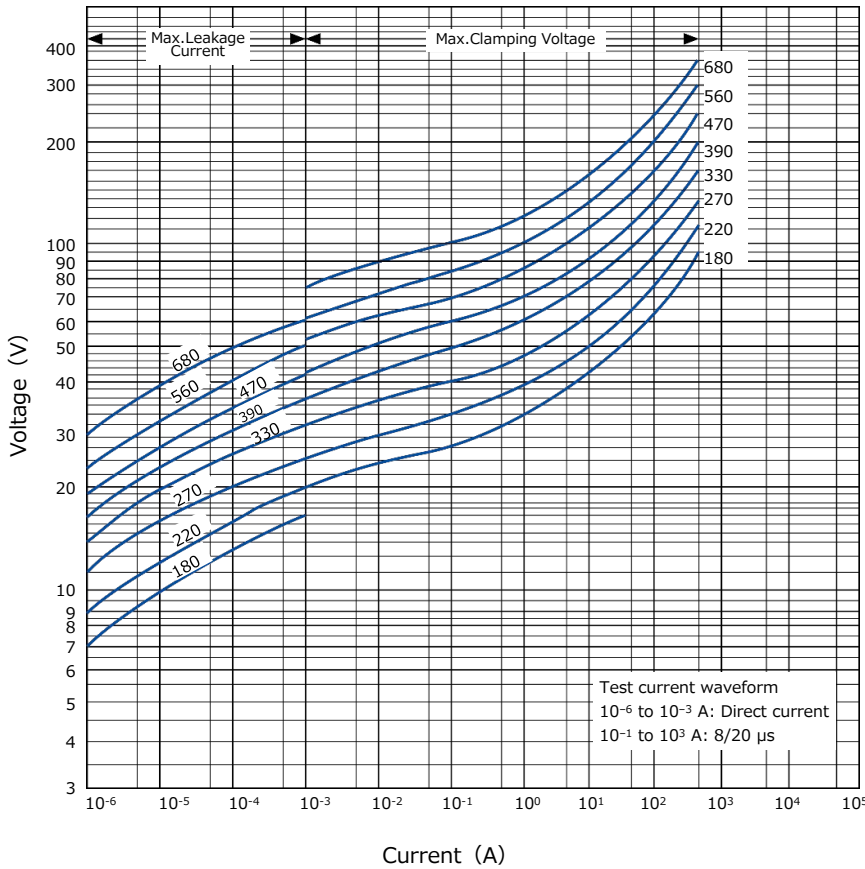

Impulse Derating (Relation between impulse width and impulse current multiple)

ERZV07D180 to ERZV07D680

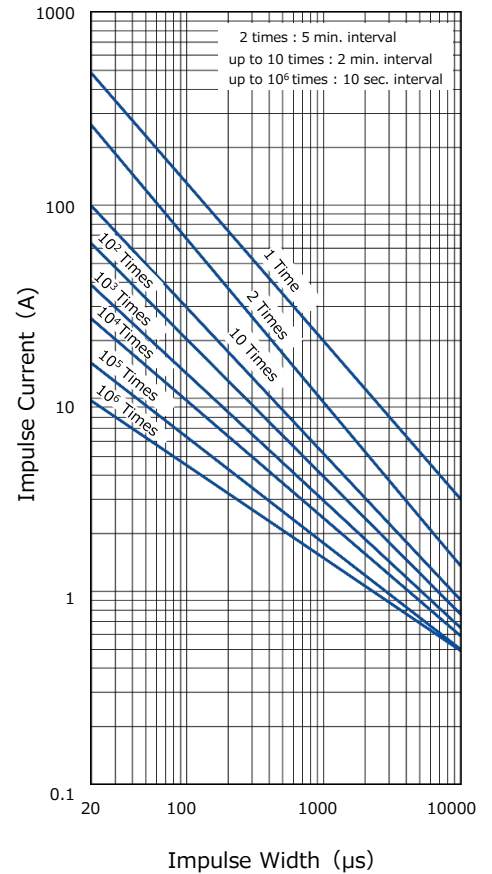

ERZV07D820 to ERZV07D511

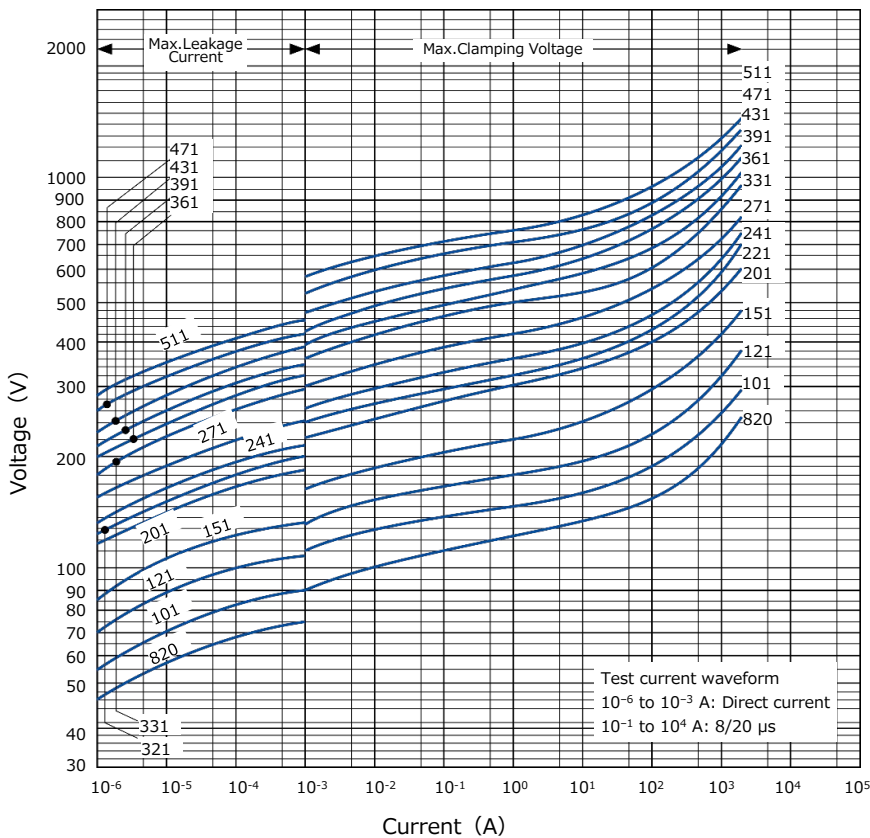

ERZV07D820 to ERZV07D511

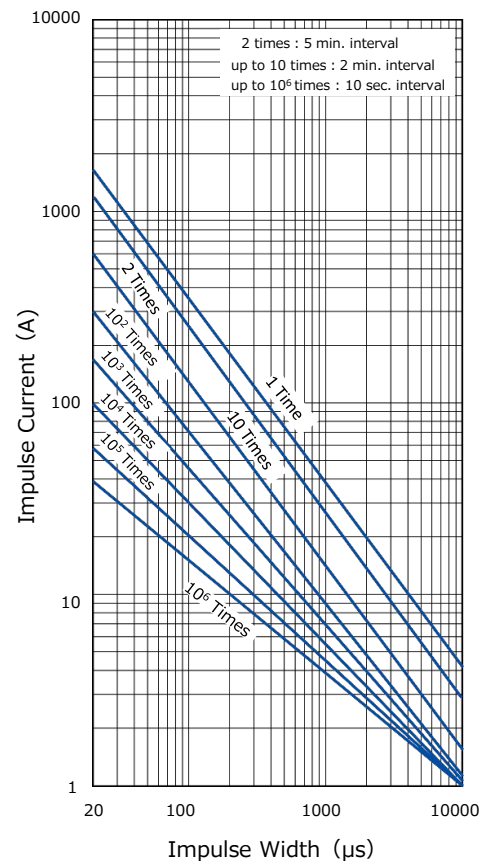

9 Series

Ratings and characteristics

● Operating Temperature Range : -40 to 85 °C ● Storage Temperature Range : -40 to 125 °C

Part No.	Varistor voltage $V_{1mA}(V)$	Maximum allowable voltage		Clamping voltage (max.) **Ip (V)	Rated power (W)	Maximum energy		Maximum peak current (8/20 μ s)		Capacitance (max.) at 1 kHz (pF)
		AC rms (V)	DC (V)			(10/1000 μ s) (J)	(2 ms) (J)	1 time (A)	2 times (A)	
ERZV09D180	18(16 to 20)	11	14	36	0.05	2.6	2.2	1000	500	16000
ERZV09D220	22(20 to 24)	14	18	43	0.05	3.2	2.6	1000	500	11000
ERZV09D270	27(24 to 30)	17	22	53	0.05	3.9	3.2	1000	500	8000
ERZV09D330	33(30 to 36)	20	26	65	0.05	4.8	4.0	1000	500	6300
ERZV09D390	39(35 to 43)	25	31	77	0.05	5.6	4.7	1000	500	5200
ERZV09D470	47(42 to 52)	30	38	93	0.05	6.8	5.6	1000	500	4600
ERZV09D560	56(50 to 62)	35	45	110	0.05	8.1	6.7	1000	500	3750
ERZV09D680	68(61 to 75)	40	56	135	0.05	9.8	8.2	1000	500	2800
ERZV09D820	82(74 to 90)	50	65	135	0.4	14.0	10	3500	2500	2000
ERZV09D101	100(90 to 110)	60	85	165	0.4	17	12	3500	2500	1700
ERZV09D121	120(108 to 132)	75	100	200	0.4	20	14.5	3500	2500	1400
ERZV09D151	150(135 to 165)	95	125	250	0.4	25	18	3500	2500	1100
ERZV09D201	200(185 to 225)	130	170	340	0.4	35	25	3500	2500	430
ERZV09D221	220(198 to 242)	140	180	360	0.4	39	27.5	3500	2500	410
ERZV09D241	240(216 to 264)	150	200	395	0.4	42	30	3500	2500	380
ERZV09D271	270(247 to 303)	175	225	455	0.4	49	35	3500	2500	350
ERZV09D331	330(297 to 363)	210	270	545	0.4	58	42	3500	2500	300
ERZV09D361	360(324 to 396)	230	300	595	0.4	65	45	3500	2500	300
ERZV09D391	390(351 to 429)	250	320	650	0.4	70	50	3500	2500	300
ERZV09D431	430(387 to 473)	275	350	710	0.4	80	55	3500	2500	270
ERZV09D471	470(423 to 517)	300	385	775	0.4	85	60	3500	2500	230
ERZV09D511	510(459 to 561)	320	410	845	0.4	92	67	3500	2500	210

*Ip Measuring current of clamping voltage 180 to 680 : 5 A, 820 to 511 : 25 A

Dimensions in mm (not to scale)

Unit : mm

Part No.	D max.	T max.	W \pm 1.0	H max.	L \pm 1.0
ERZV09D180	11.5	3.8	5.0	14.0	1.3
ERZV09D220	11.5	4.0	5.0	14.0	1.4
ERZV09D270	11.5	4.2	5.0	14.0	1.5
ERZV09D330	11.5	4.5	5.0	14.0	1.7
ERZV09D390	11.5	4.0	5.0	14.0	1.7
ERZV09D470	11.5	4.2	5.0	14.0	1.8
ERZV09D560	11.5	4.4	5.0	14.0	1.9
ERZV09D680	11.5	4.5	5.0	14.0	2.2
ERZV09D820	11.5	3.8	5.0	14.0	1.6
ERZV09D101	11.5	3.9	5.0	14.0	1.8
ERZV09D121	11.5	4.1	5.0	14.0	2.0
ERZV09D151	11.5	4.4	5.0	14.0	2.2
ERZV09D201	11.5	4.1	5.0	14.0	1.7
ERZV09D221	11.5	4.2	5.0	14.0	1.8
ERZV09D241	11.5	4.3	5.0	14.0	1.9
ERZV09D271	11.5	4.5	5.0	14.0	2.0
ERZV09D331	11.5	4.8	5.0	14.0	2.3
ERZV09D361	11.5	5.0	5.0	14.0	2.5
ERZV09D391	11.5	5.1	5.0	14.0	2.6
ERZV09D431	11.5	5.3	5.0	14.0	2.8
ERZV09D471	11.5	5.6	5.0	14.0	3.1
ERZV09D511	11.5	5.8	5.0	14.0	3.2

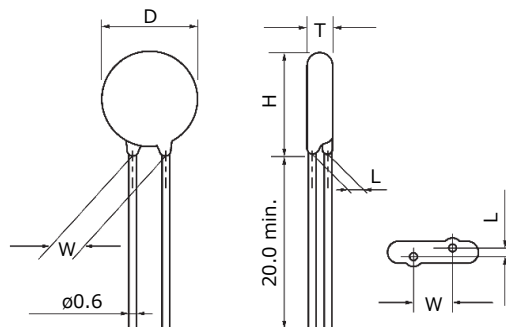

Typical Characteristics

Voltage vs. Current

ERZV09D180 to ERZV09D680

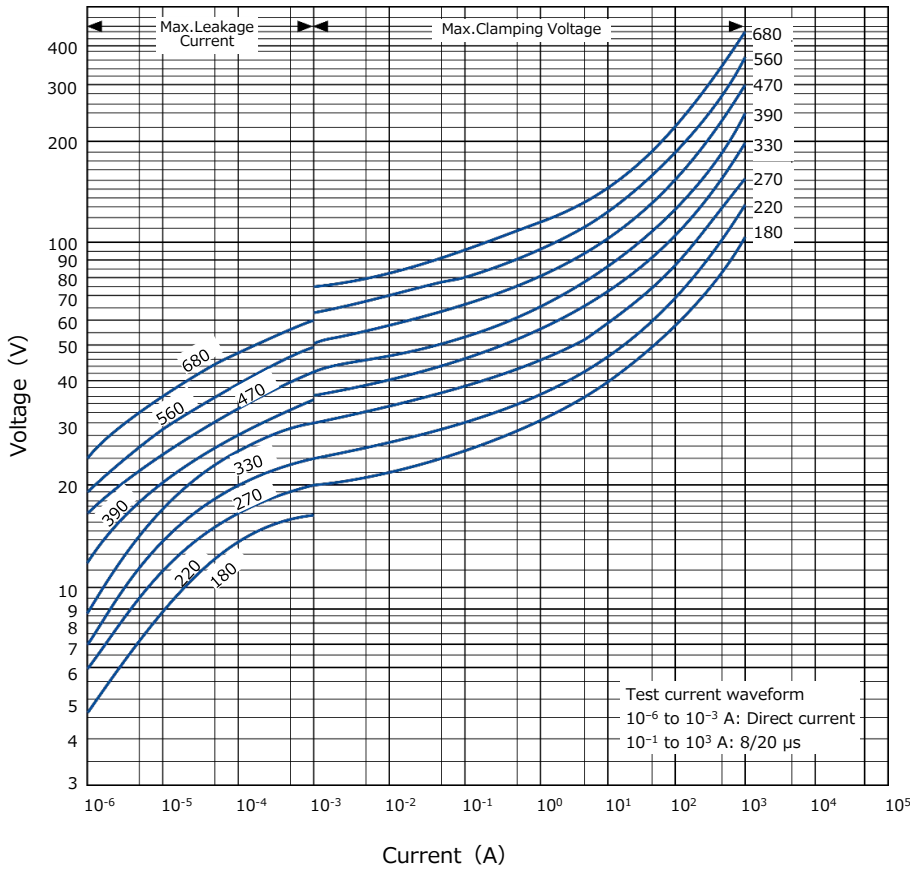

Impulse Derating (Relation between impulse width and impulse current multiple)

ERZV09D180 to ERZV09D680

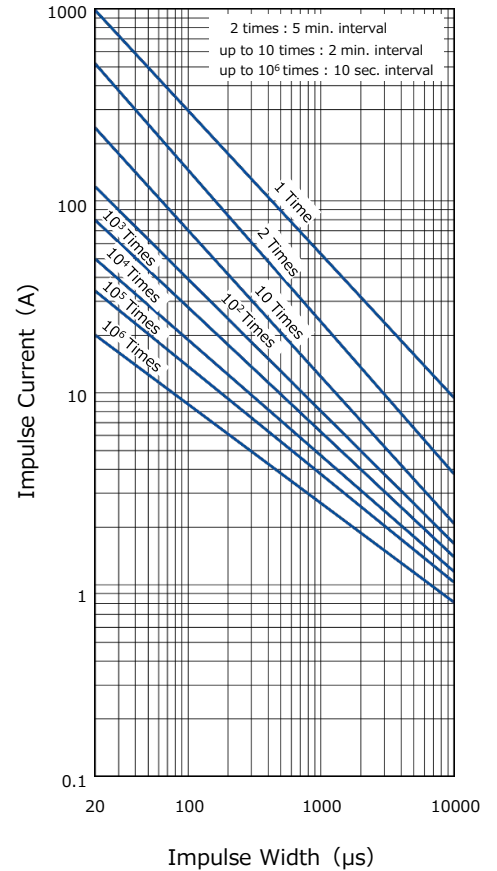

ERZV09D820 to ERZV09D511

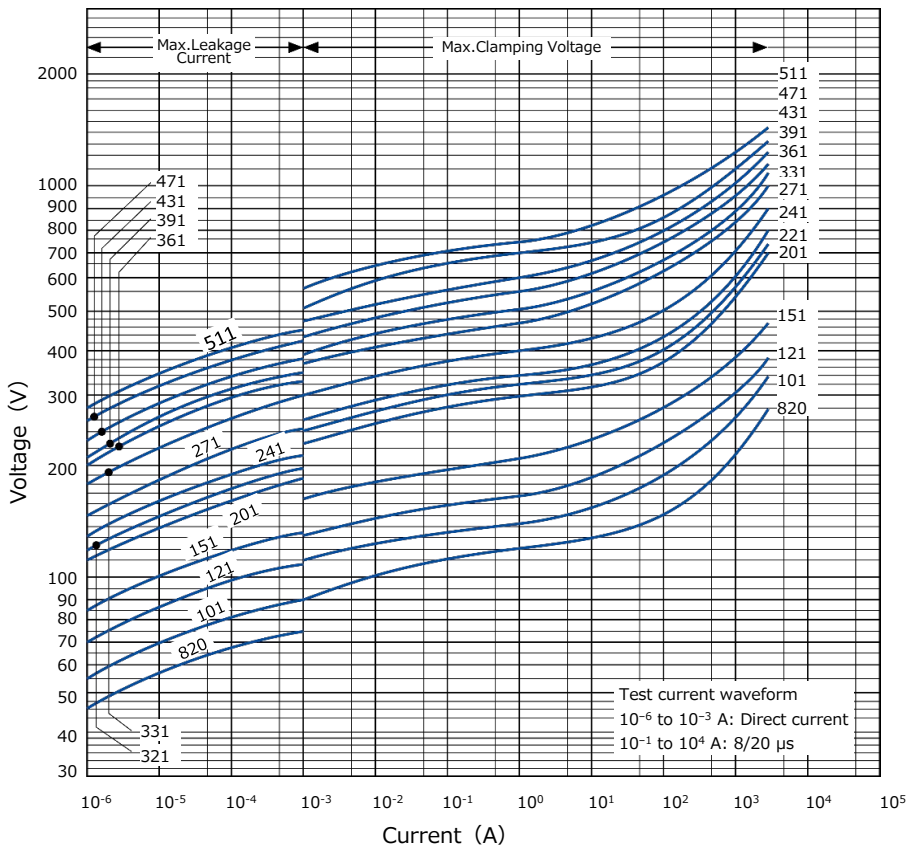

ERZV09D820 to ERZV09D511

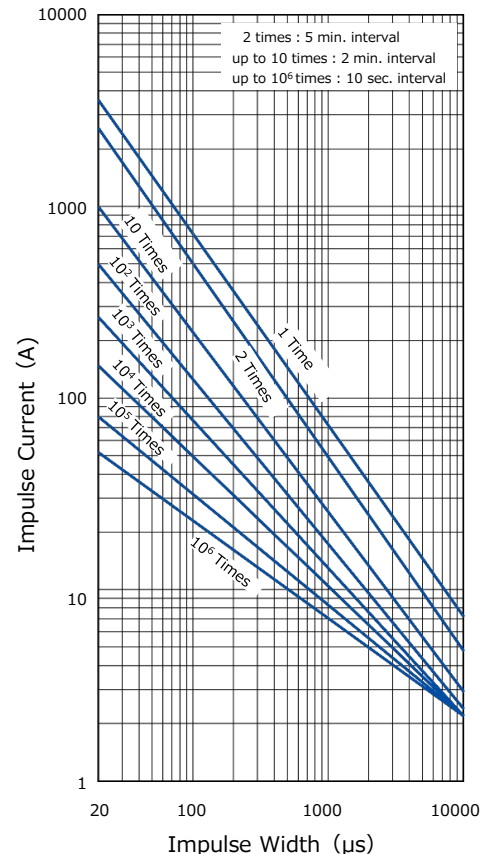

10 Series

Ratings and characteristics

● Operating Temperature Range : -40 to 85 °C ● Storage Temperature Range : -40 to 125 °C

Part No.	Varistor voltage $V_{1mA}(V)$	Maximum allowable voltage		Clamping voltage (max.) **Ip (V)	Rated power (W)	Maximum energy		Maximum peak current (8/20 μs)		Capacitance (max.) at 1 kHz (pF)
		AC rms (V)	DC (V)			(10/1000 μs) (J)	(2 ms) (J)	1 time (A)	2 times (A)	
ERZV10D180	18(16 to 20)	11	14	36	0.05	2.6	2.2	1000	500	16000
ERZV10D220	22(20 to 24)	14	18	43	0.05	3.2	2.6	1000	500	11000
ERZV10D270	27(24 to 30)	17	22	53	0.05	3.9	3.2	1000	500	8000
ERZV10D330	33(30 to 36)	20	26	65	0.05	4.8	4.0	1000	500	6300
ERZV10D390	39(35 to 43)	25	31	77	0.05	5.6	4.7	1000	500	5200
ERZV10D470	47(42 to 52)	30	38	93	0.05	6.8	5.6	1000	500	4600
ERZV10D560	56(50 to 62)	35	45	110	0.05	8.1	6.7	1000	500	3750
ERZV10D680	68(61 to 75)	40	56	135	0.05	9.8	8.2	1000	500	2800
ERZV10D820	82(74 to 90)	50	65	135	0.4	14	10	3500	2500	2000
ERZV10D101	100(90 to 110)	60	85	165	0.4	17	12	3500	2500	1700
ERZV10D121	120(108 to 132)	75	100	200	0.4	20	14.5	3500	2500	1400
ERZV10D151	150(135 to 165)	95	125	250	0.4	25	18	3500	2500	1100
ERZV10D201	200(185 to 225)	130	170	340	0.4	35	25	3500	2500	430
ERZV10D221	220(198 to 242)	140	180	360	0.4	39	27.5	3500	2500	410
ERZV10D241	240(216 to 264)	150	200	395	0.4	42	30	3500	2500	380
ERZV10D271	270(247 to 303)	175	225	455	0.4	49	35	3500	2500	350
ERZV10D331	330(297 to 363)	210	270	545	0.4	58	42	3500	2500	300
ERZV10D361	360(324 to 396)	230	300	595	0.4	65	45	3500	2500	300
ERZV10D391	390(351 to 429)	250	320	650	0.4	70	50	3500	2500	300
ERZV10D431	430(387 to 473)	275	350	710	0.4	80	55	3500	2500	270
ERZV10D471	470(423 to 517)	300	385	775	0.4	85	60	3500	2500	230
ERZV10D511	510(459 to 561)	320	410	845	0.4	92	67	3500	2500	210
ERZV10D561	560(504 to 616)	350	450	930	0.4	92	67	3500	2500	200
ERZV10D621	620(558 to 682)	385	505	1025	0.4	92	67	3500	2500	190
ERZV10D681	680(612 to 748)	420	560	1120	0.4	92	67	3500	2500	170
ERZV10D751	750(675 to 825)	460	615	1240	0.4	100	70	3500	2500	160
ERZV10D821	820(738 to 902)	510	670	1355	0.4	110	80	3500	2500	140
ERZV10D911	910(819 to 1001)	550	745	1500	0.4	130	90	3500	2500	120
ERZV10D102	1000(900 to 1100)	625	825	1650	0.4	140	100	3500	2500	110
ERZV10D112	1100(990 to 1210)	680	895	1815	0.4	155	110	3500	2500	110
ERZV10D182CS	1800(1700 to 1980)	1000	1465	2970	0.4	247	183	3500	2500	70*

*Measured at 1 MHz **Ip Measuring current of clamping voltage 180 to 680 : 5 A, 820 to 182 : 25 A

Dimensions in mm (not to scale)

Part No.	D max.	T max.	W±1.0	H max.	Unit : mm	
					L±1.0	
ERZV10D180	11.5	4.6	7.5	14.5	1.3	
ERZV10D220	11.5	4.7	7.5	14.5	1.4	
ERZV10D270	11.5	4.8	7.5	14.5	1.5	
ERZV10D330	11.5	5.0	7.5	14.5	1.7	
ERZV10D390	11.5	4.9	7.5	14.5	1.6	
ERZV10D470	11.5	5.0	7.5	14.5	1.7	
ERZV10D560	11.5	5.1	7.5	14.5	1.8	
ERZV10D680	11.5	5.3	7.5	14.5	2.0	
ERZV10D820	11.5	4.5	7.5	14.5	1.6	
ERZV10D101	11.5	4.7	7.5	14.5	1.8	
ERZV10D121	11.5	4.9	7.5	14.5	2.0	
ERZV10D151	11.5	5.2	7.5	14.5	2.3	
ERZV10D201	11.5	4.8	7.5	14.5	1.9	
ERZV10D221	11.5	4.9	7.5	14.5	2.0	
ERZV10D241	11.5	5.0	7.5	14.5	2.1	
ERZV10D271	11.5	5.2	7.5	14.5	2.3	
ERZV10D331	11.5	5.5	7.5	14.5	2.6	
ERZV10D361	11.5	5.7	7.5	14.5	2.8	
ERZV10D391	11.5	5.8	7.5	14.5	2.9	
ERZV10D431	11.5	6.0	7.5	14.5	3.1	
ERZV10D471	11.5	6.2	7.5	14.5	3.3	
ERZV10D511	11.5	6.4	7.5	14.5	3.5	
ERZV10D561	12.5	6.7	7.5	15.5	3.8	
ERZV10D621	12.5	7.1	7.5	15.5	4.2	
ERZV10D681	12.5	7.4	7.5	15.5	4.5	
ERZV10D751	12.5	7.8	7.5	15.5	4.9	
ERZV10D821	12.5	8.1	7.5	15.5	5.2	
ERZV10D911	12.5	8.6	7.5	15.5	5.7	
ERZV10D102	12.5	9.1	7.5	15.5	6.2	
ERZV10D112	12.5	9.7	7.5	15.5	6.8	
ERZV10D182CS	13.5	14.4	11.0*	16.5	10.0 (±1.5)	

* W₂

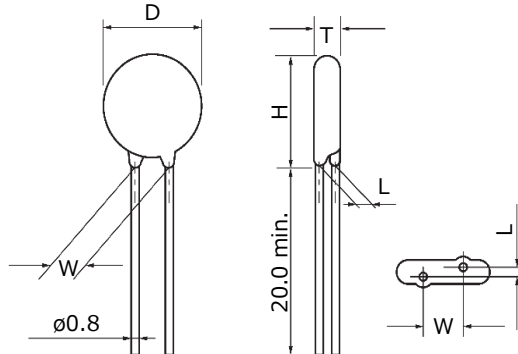

(ERZV10D182CS)

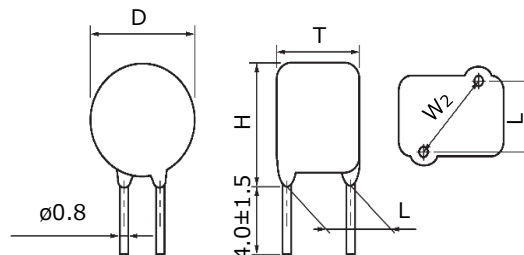

Typical Characteristics

Voltage vs. Current

ERZV10D180 to ERZV10D680

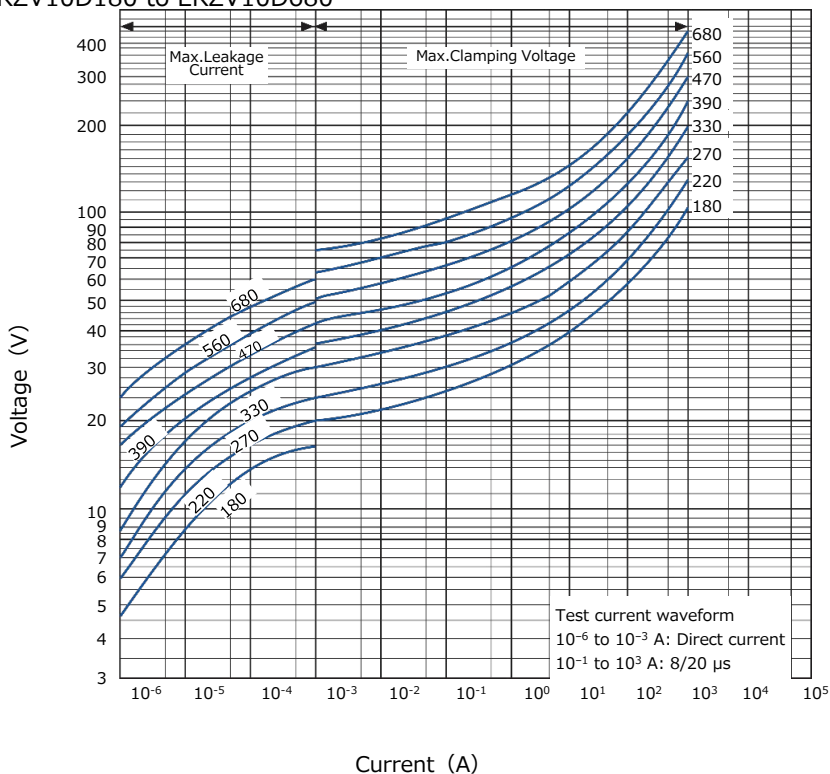

Impulse Derating (Relation between impulse width and impulse current multiple)

ERZV10D180 to ERZV10D680

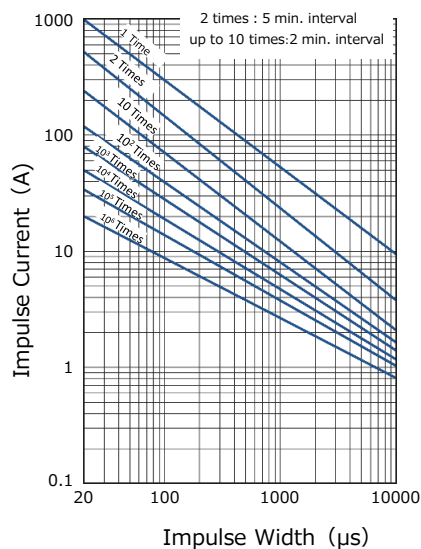

Typical Characteristics

Voltage vs. Current

ERZV10D820 to ERZV10D511

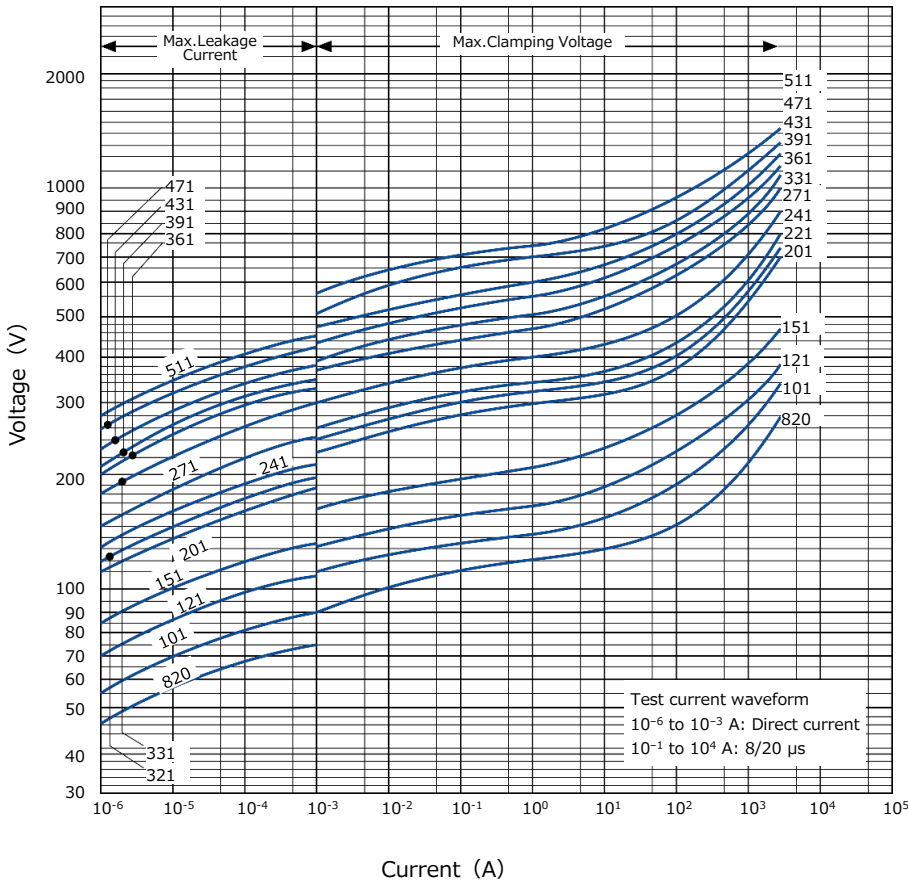

Impulse Derating (Relation between impulse width and impulse current multiple)

ERZV10D820 to ERZV10D511

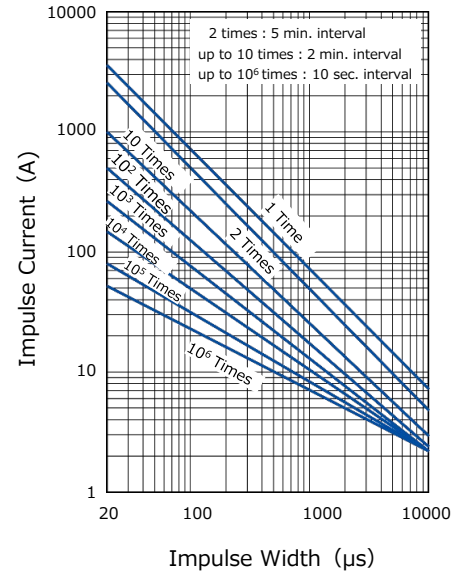

ERZV10D561 to ERZV10D112

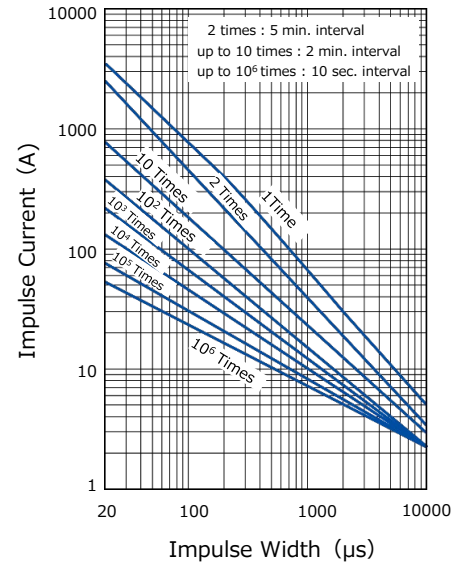

ERZV10D561 to ERZV10D182CS

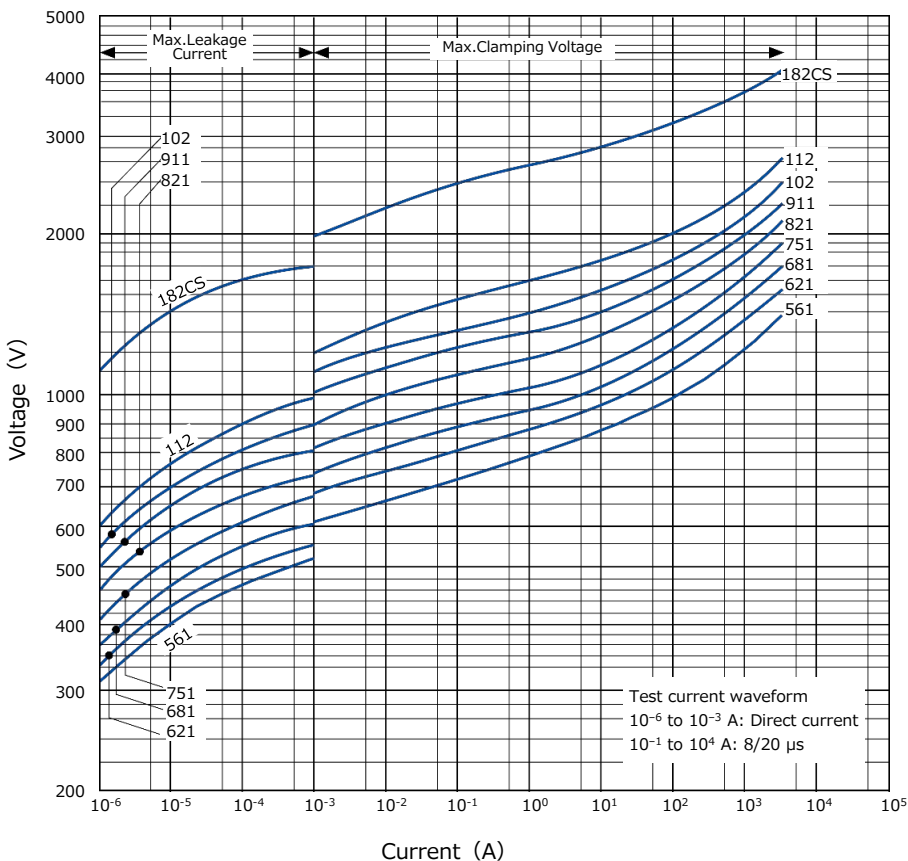

ERZV10D182CS

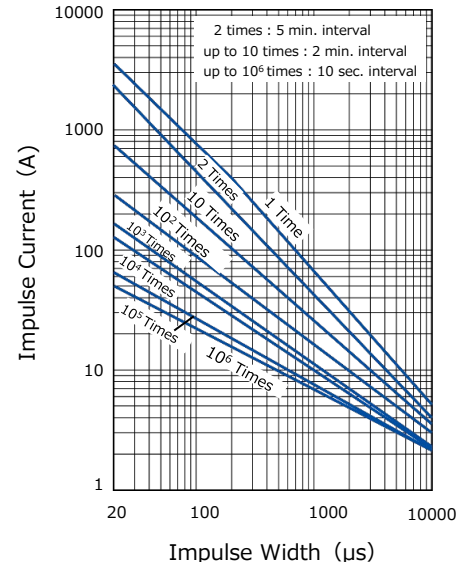

14 Series

Ratings and characteristics

● Operating Temperature Range : -40 to 85 °C ● Storage Temperature Range : -40 to 125 °C

Part No.	Varistor voltage $V_{1mA}(V)$	Maximum allowable voltage		Clamping voltage (max.) **Ip (V)	Rated power (W)	Maximum energy		Maximum peak current (8/20 μs)		Capacitance (max.) at 1 kHz (pF)
		AC rms (V)	DC (V)			(10/1000 μs) (J)	(2 ms) (J)	1 time (A)	2 times (A)	
ERZV14D180	18(16 to 20)	11	14	36	0.1	5.2	4.3	2000	1000	25000
ERZV14D220	22(20 to 24)	14	18	43	0.1	6.3	5.3	2000	1000	20000
ERZV14D270	27(24 to 30)	17	22	53	0.1	7.8	6.5	2000	1000	16000
ERZV14D330	33(30 to 36)	20	26	65	0.1	9.5	7.9	2000	1000	12200
ERZV14D390	39(35 to 43)	25	31	77	0.1	11	9.4	2000	1000	7000
ERZV14D470	47(42 to 52)	30	38	93	0.1	14	11	2000	1000	6750
ERZV14D560	56(50 to 62)	35	45	110	0.1	16	13	2000	1000	6500
ERZV14D680	68(61 to 75)	40	56	135	0.1	20	16	2000	1000	5500
ERZV14D820	82(74 to 90)	50	65	135	0.6	28	20	6000	5000	3700
ERZV14D101	100(90 to 110)	60	85	165	0.6	35	25	6000	5000	3200
ERZV14D121	120(108 to 132)	75	100	200	0.6	42	30	6000	5000	2700
ERZV14D151	150(135 to 165)	95	125	250	0.6	53	37.5	6000	5000	2200
ERZV14D201	200(185 to 225)	130	170	340	0.6	70	50	6000	5000	770
ERZV14D221	220(198 to 242)	140	180	360	0.6	78	55	6000	5000	740
ERZV14D241	240(216 to 264)	150	200	395	0.6	84	60	6000	5000	700
ERZV14D271	270(247 to 303)	175	225	455	0.6	99	70	6000	5000	640
ERZV14D331	330(297 to 363)	210	270	545	0.6	115	80	6000	4500	580
ERZV14D361	360(324 to 396)	230	300	595	0.6	130	90	6000	4500	540
ERZV14D391	390(351 to 429)	250	320	650	0.6	140	100	6000	4500	500
ERZV14D431	430(387 to 473)	275	350	710	0.6	155	110	6000	4500	450
ERZV14D471	470(423 to 517)	300	385	775	0.6	175	125	6000	4500	400
ERZV14D511	510(459 to 561)	320	410	845	0.6	190	136	6000	4500	350
ERZV14D561	560(504 to 616)	350	450	930	0.6	190	136	5000	4500	340
ERZV14D621	620(558 to 682)	385	505	1025	0.6	190	136	5000	4500	330
ERZV14D681	680(612 to 748)	420	560	1120	0.6	190	136	5000	4500	320
ERZV14D751	750(675 to 825)	460	615	1240	0.6	210	150	5000	4500	310
ERZV14D821	820(738 to 902)	510	670	1355	0.6	235	165	5000	4500	280
ERZV14D911	910(819 to 1001)	550	745	1500	0.6	255	180	5000	4500	250
ERZV14D102	1000(900 to 1100)	625	825	1650	0.6	280	200	5000	4500	230
ERZV14D112	1100(990 to 1210)	680	895	1815	0.6	310	220	5000	4500	210
ERZV14D182CS	1800(1700 to 1980)	1000	1465	2970	0.6	510	360	5000	4500	120

*Ip Measuring current of clamping voltage 180 to 680 : 10 A, 820 to 182 : 50 A

Dimensions in mm (not to scale)

Unit : mm					
Part No.	D max.	T max.	W±1.0	H max.	L±1.0
ERZV14D180	15.5	4.6	7.5	18.5	1.3
ERZV14D220	15.5	4.7	7.5	18.5	1.4
ERZV14D270	15.5	4.8	7.5	18.5	1.5
ERZV14D330	15.5	5.0	7.5	18.5	1.7
ERZV14D390	15.5	4.9	7.5	18.5	1.6
ERZV14D470	15.5	5.0	7.5	18.5	1.7
ERZV14D560	15.5	5.1	7.5	18.5	1.8
ERZV14D680	15.5	5.3	7.5	18.5	2.0
ERZV14D820	15.5	4.5	7.5	18.5	1.6
ERZV14D101	15.5	4.7	7.5	18.5	1.8
ERZV14D121	15.5	4.9	7.5	18.5	2.0
ERZV14D151	15.5	5.2	7.5	18.5	2.3
ERZV14D201	15.5	4.8	7.5	18.5	1.9
ERZV14D221	15.5	4.9	7.5	18.5	2.0
ERZV14D241	15.5	5.0	7.5	18.5	2.1
ERZV14D271	15.5	5.2	7.5	18.5	2.3
ERZV14D331	15.5	5.5	7.5	18.5	2.6
ERZV14D361	15.5	5.7	7.5	18.5	2.8
ERZV14D391	15.5	5.8	7.5	18.5	2.9
ERZV14D431	15.5	6.0	7.5	18.5	3.1
ERZV14D471	15.5	6.2	7.5	18.5	3.3
ERZV14D511	15.5	6.4	7.5	18.5	3.5
ERZV14D561	16.0	6.7	7.5	19.0	3.8
ERZV14D621	16.0	7.1	7.5	19.0	4.2
ERZV14D681	16.0	7.4	7.5	19.0	4.5
ERZV14D751	16.0	7.8	7.5	19.0	4.9
ERZV14D821	16.0	8.1	7.5	19.0	5.2
ERZV14D911	16.0	8.6	7.5	19.0	5.7
ERZV14D102	16.0	9.1	7.5	19.0	6.2
ERZV14D112	16.0	9.7	7.5	19.0	6.8
ERZV14D182CS	17.0	14.4	15.0*	20.5	10.5 (±2.0)

* : W₂

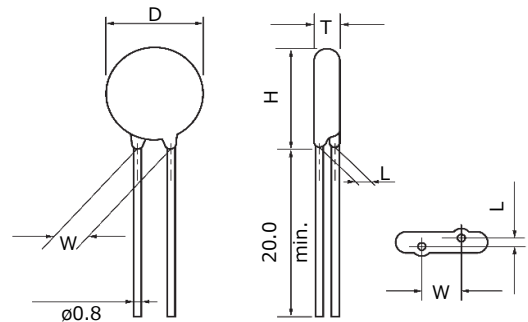

(ERZV14D182CS)

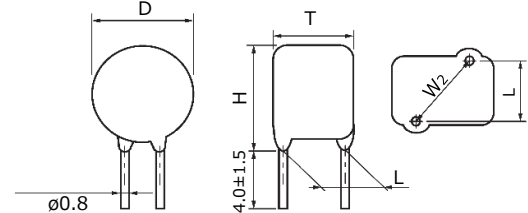

Typical Characteristics

Voltage vs. Current

ERZV14D180 to ERZV14D680

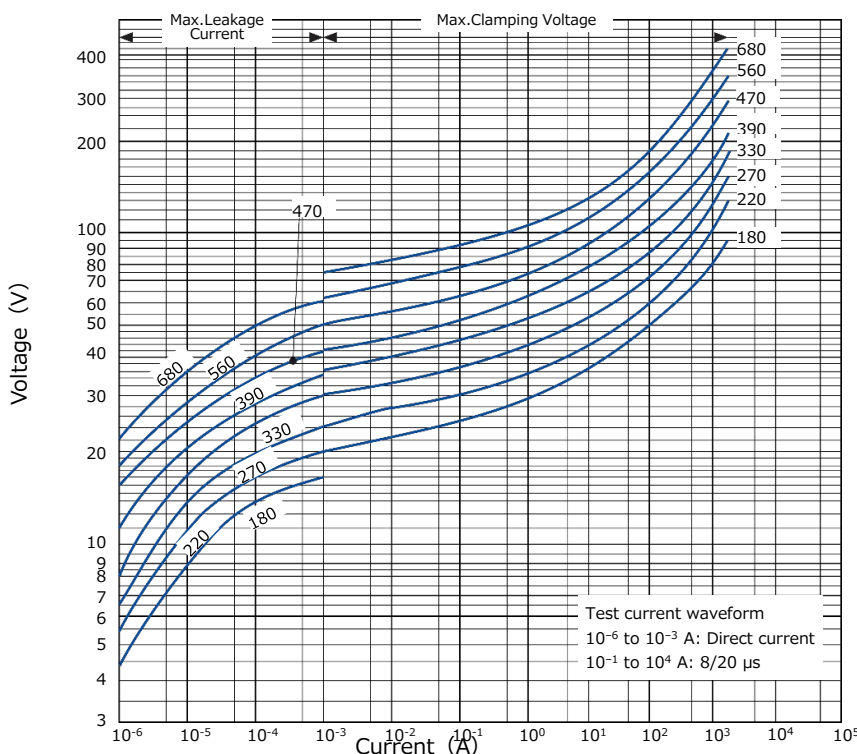

Impulse Derating (Relation between impulse width and impulse current multiple)

ERZV14D180 to ERZV14D680

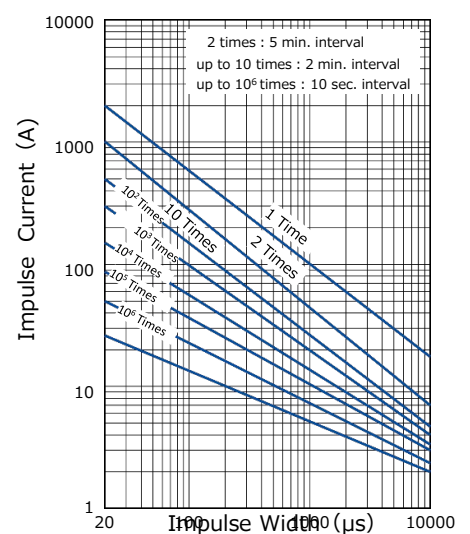

Typical Characteristics

Voltage vs. Current

ERZV14D820 to ERZV14D511

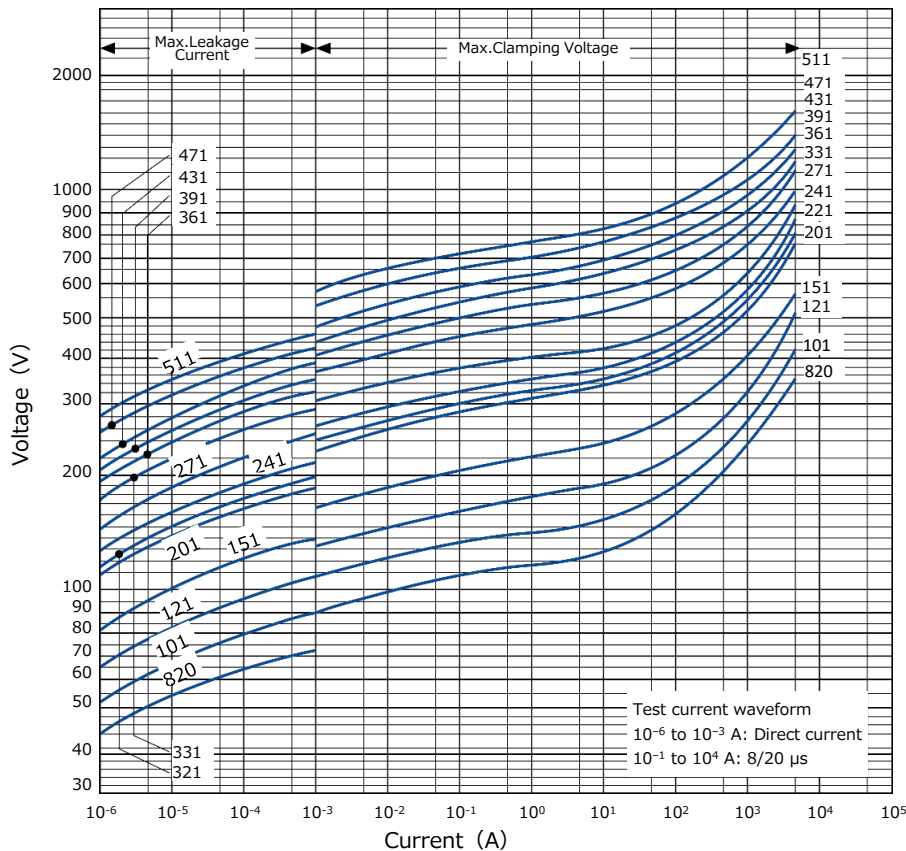

ERZV14D561 to ERZV14D182CS

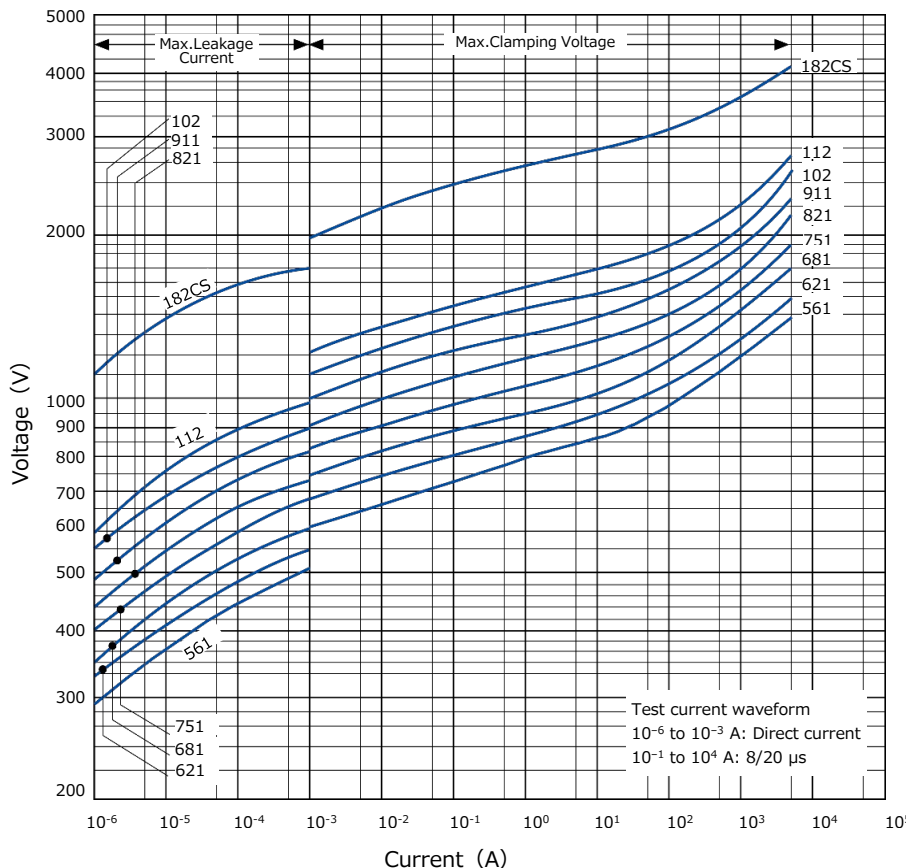

Impulse Derating (Relation between impulse width and impulse current multiple)

ERZV14D820 to ERZV14D511

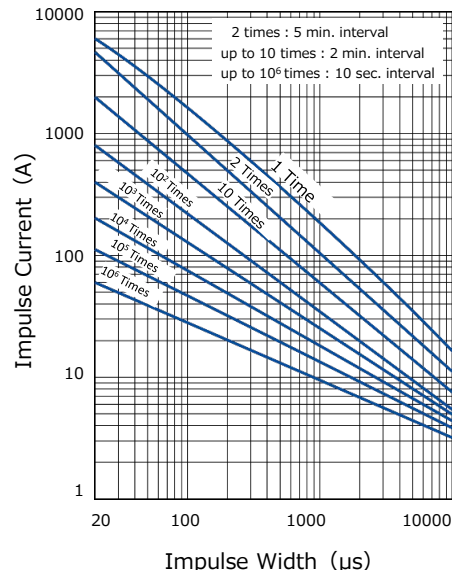

ERZV14D561 to ERZV14D112

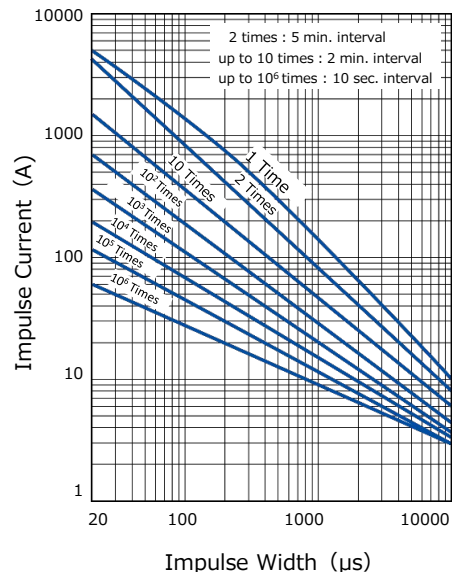

ERZV14D182CS

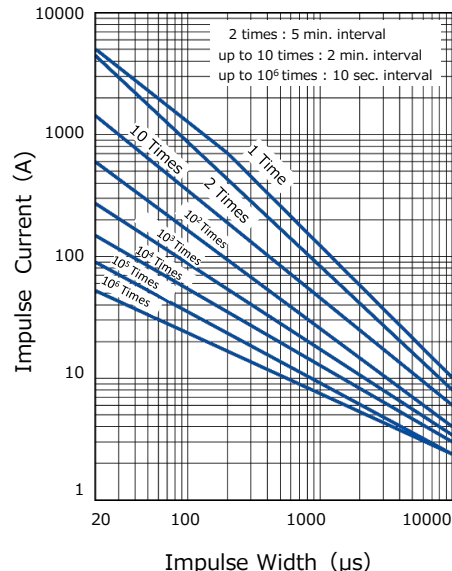

20 Series

Ratings and characteristics

● Operating Temperature Range : -40 to 85 °C ● Storage Temperature Range : -40 to 125 °C

Part No.	Varistor voltage	Maximum allowable voltage		Clamping voltage (max.) **Ip (V)	Rated power (W)	Maximum energy		Maximum peak current (8/20 μs)		Capacitance (max.) at 1 kHz (pF)
		AC rms (V)	DC (V)			(10/1000 μs)	(2 ms)	1 time	2 times	
	V _{1mA} (V)					(J)	(J)	(A)	(A)	
ERZV20D180	18(16 to 20)	11	14	36	0.2	13	12	3000	2000	40000
ERZV20D220	22(20 to 24)	14	18	43	0.2	16	14	3000	2000	30000
ERZV20D270	27(24 to 30)	17	22	53	0.2	19	17	3000	2000	24500
ERZV20D330	33(30 to 36)	20	26	65	0.2	24	21	3000	2000	20000
ERZV20D390	39(35 to 43)	25	31	77	0.2	28	25	3000	2000	13800
ERZV20D470	47(42 to 52)	30	38	93	0.2	34	30	3000	2000	13500
ERZV20D560	56(50 to 62)	35	45	110	0.2	41	36	3000	2000	12200
ERZV20D680	68(61 to 75)	40	56	135	0.2	49	44	3000	2000	11500
ERZV20D820	82(74 to 90)	50	65	135	1.0	56	40	10000	7000	7500
ERZV20D101	100(90 to 110)	60	85	165	1.0	70	50	10000	7000	6500
ERZV20D121	120(108 to 132)	75	100	200	1.0	85	60	10000	7000	5500
ERZV20D151	150(135 to 165)	95	125	250	1.0	106	75	10000	7000	4500
ERZV20D201	200(185 to 225)	130	170	340	1.0	140	100	10000	7000	1700
ERZV20D221	220(198 to 242)	140	180	360	1.0	155	110	10000	7000	1600
ERZV20D241	240(216 to 264)	150	200	395	1.0	168	120	10000	7000	1500
ERZV20D271	270(247 to 303)	175	225	455	1.0	190	135	10000	7000	1300
ERZV20D331	330(297 to 363)	210	270	545	1.0	228	160	10000	6500	1100
ERZV20D361	360(324 to 396)	230	300	595	1.0	255	180	10000	6500	1100
ERZV20D391	390(351 to 429)	250	320	650	1.0	275	195	10000	6500	1100
ERZV20D431	430(387 to 473)	275	350	710	1.0	303	215	10000	6500	1000
ERZV20D471	470(423 to 517)	300	385	775	1.0	350	250	10000	6500	900
ERZV20D511	510(459 to 561)	320	410	845	1.0	382	273	10000	6500	800
ERZV20D561	560(504 to 616)	350	450	930	1.0	382	273	7500	6500	750
ERZV20D621	620(558 to 682)	385	505	1025	1.0	382	273	7500	6500	700
ERZV20D681	680(612 to 748)	420	560	1120	1.0	382	273	7500	6500	650
ERZV20D751	750(675 to 825)	460	615	1240	1.0	420	300	7500	6500	600
ERZV20D821	820(738 to 902)	510	670	1355	1.0	460	325	7500	6500	530
ERZV20D911	910(819 to 1001)	550	745	1500	1.0	510	360	7500	6500	500
ERZV20D102	1000(900 to 1100)	625	825	1650	1.0	565	400	7500	6500	450
ERZV20D112	1100(990 to 1210)	680	895	1815	1.0	620	440	7500	6500	400
ERZV20D182	1800(1700 to 1980)	1000	1465	2970	1.0	1020	720	7500	6500	250

*Ip Measuring current of clamping voltage 180 to 680 : 20 A, 820 to 182 : 100 A

Dimensions in mm (not to scale)

Unit : mm					
Part No.	D max.	T max.	W±1.0	H max.	L±1.0
ERZV20D180	21.5	5.1	10.0	24.5	1.5
ERZV20D220	21.5	5.2	10.0	24.5	1.6
ERZV20D270	21.5	5.3	10.0	24.5	1.7
ERZV20D330	21.5	5.5	10.0	24.5	1.9
ERZV20D390	21.5	5.5	10.0	24.5	1.9
ERZV20D470	21.5	5.6	10.0	24.5	2.0
ERZV20D560	21.5	5.7	10.0	24.5	2.1
ERZV20D680	21.5	5.8	10.0	24.5	2.2
ERZV20D820	21.5	4.9	10.0	24.5	1.8
ERZV20D101	21.5	5.1	10.0	24.5	2.0
ERZV20D121	21.5	5.3	10.0	24.5	2.2
ERZV20D151	21.5	5.6	10.0	24.5	2.5
ERZV20D201	21.5	5.2	10.0	24.5	2.1
ERZV20D221	21.5	5.3	10.0	24.5	2.2
ERZV20D241	21.5	5.4	10.0	24.5	2.3
ERZV20D271	21.5	5.6	10.0	24.5	2.5
ERZV20D331	21.5	5.9	10.0	24.5	2.8
ERZV20D361	21.5	6.1	10.0	24.5	3.0
ERZV20D391	21.5	6.2	10.0	24.5	3.1
ERZV20D431	21.5	6.4	10.0	24.5	3.3
ERZV20D471	21.5	6.6	10.0	24.5	3.5
ERZV20D511	21.5	6.8	10.0	24.5	3.7
ERZV20D561	22.5	7.1	10.0	25.5	4.2
ERZV20D621	22.5	7.5	10.0	25.5	4.4
ERZV20D681	22.5	7.8	10.0	25.5	4.7
ERZV20D751	22.5	8.2	10.0	25.5	5.1
ERZV20D821	22.5	8.5	10.0	25.5	5.4
ERZV20D911	22.5	9.0	10.0	25.5	5.9
ERZV20D102	22.5	9.5	10.0	25.5	6.4
ERZV20D112	22.5	10.1	10.0	25.5	7.0
ERZV20D182	23.5	14.8	15.0*	28.0	10.7 (±2.0)

* : W2

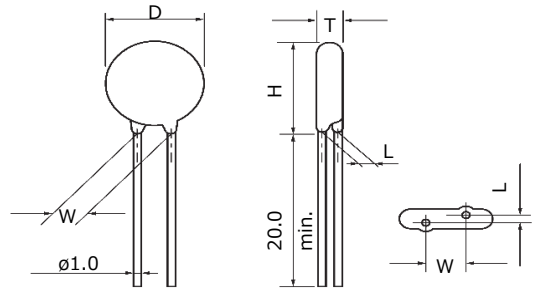

(ERZV20D182)

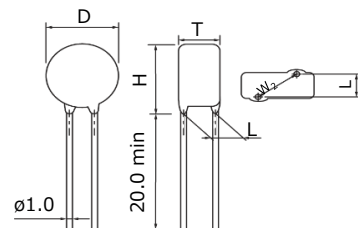

Typical Characteristics

Voltage vs. Current

ERZV20D180 to ERZV20D680

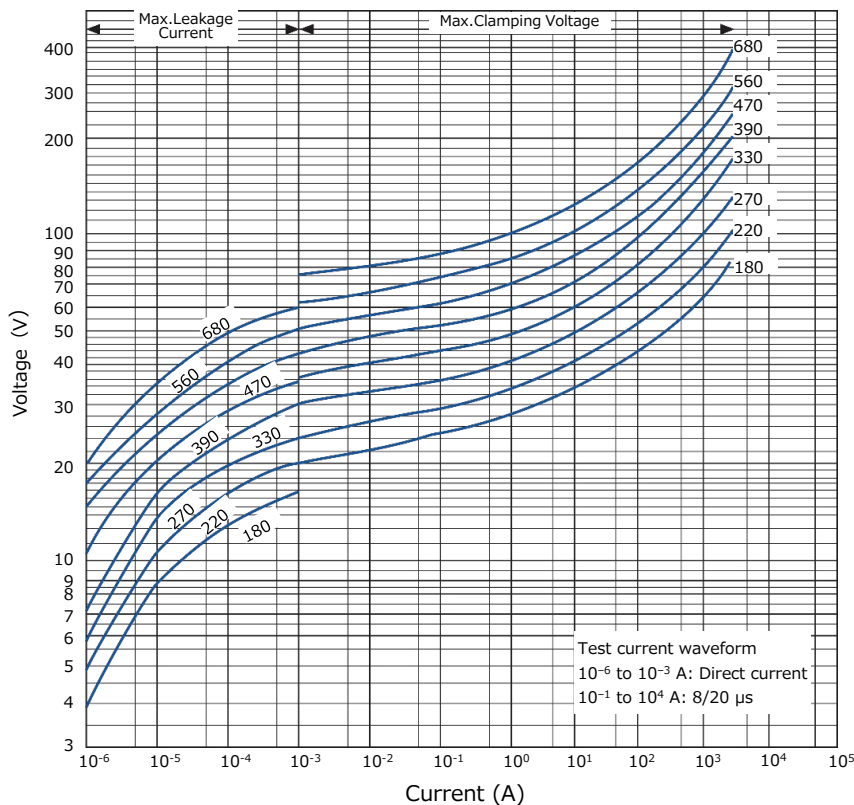

Impulse Derating (Relation between impulse width and impulse current multiple)
ERZV20D180 to ERZV20D680

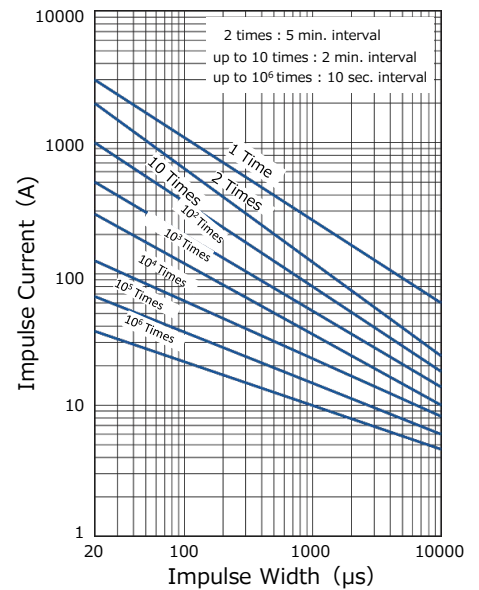

Typical Characteristics

Voltage vs. Current

ERZV20D820 to ERZV20D511

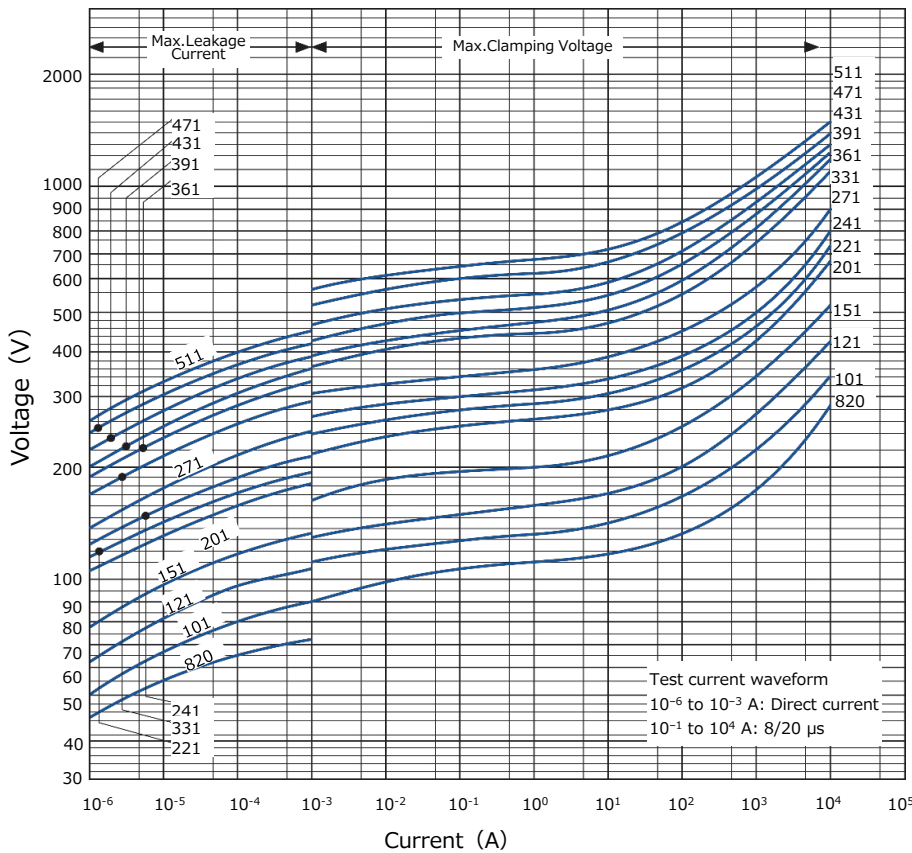

ERZV20D561 to ERZV20D182

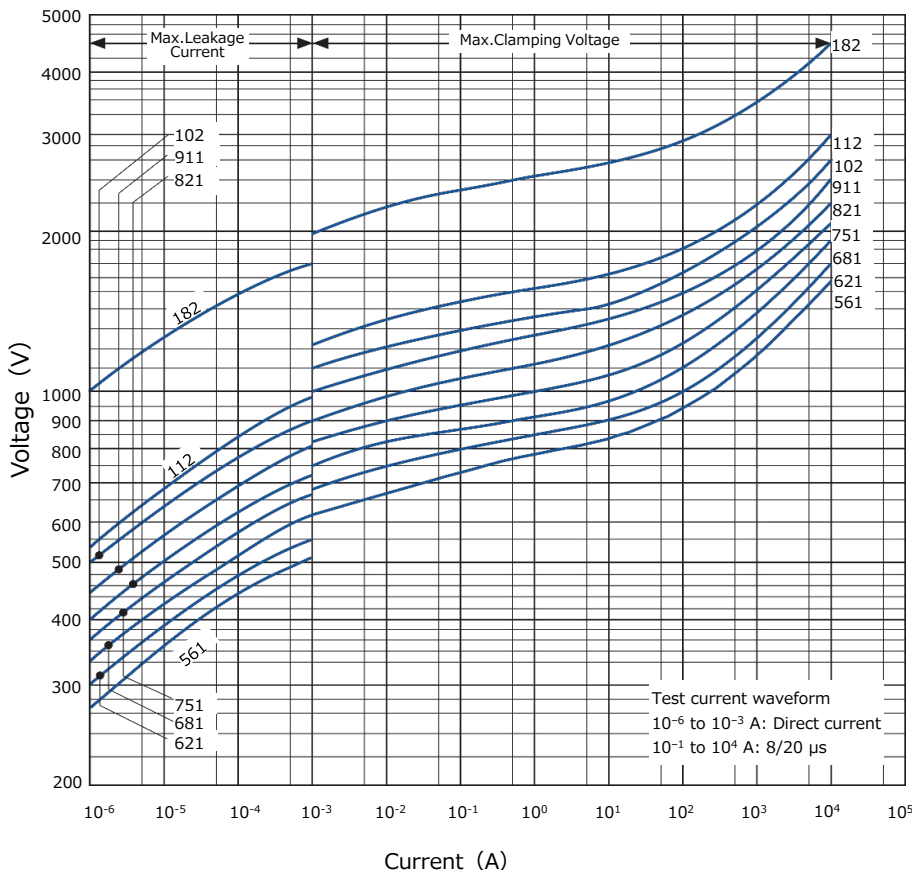

Impulse Derating (Relation between impulse width and impulse current multiple)

ERZV20D820 to ERZV20D511

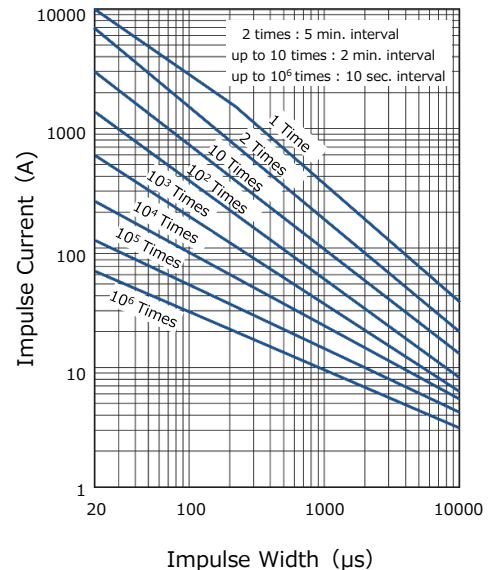

ERZV20D561 to ERZV20D112

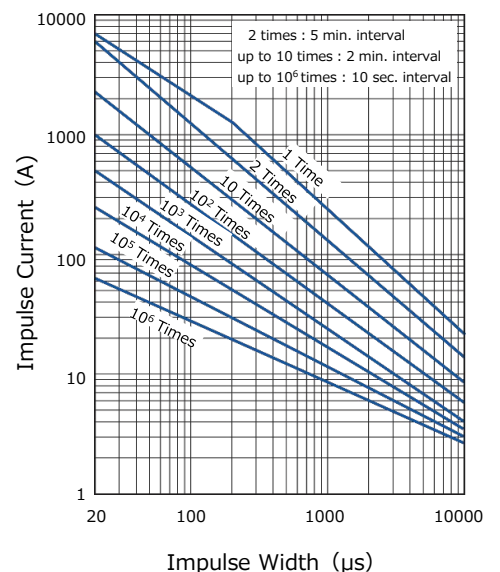

ERZV20D182

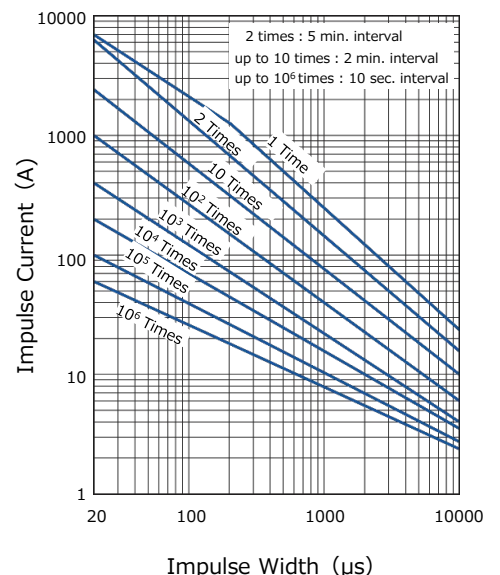

Straight Leads Cut Type (Bulk Type)

Ratings and Characteristics

※Refer to bulk standard type.

Dimensions in mm (not to scale)

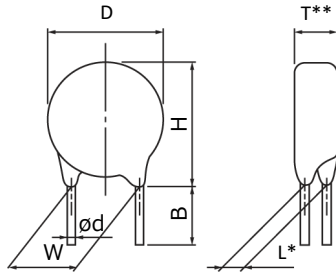

notes * Dimension "L": Conforms to each individual specification.
 ** Dimension "T": Conforms to each individual specification.

Unit : mm

Series	5	7	9	10			14		
Varistor Voltage	180 to 471	180 to 511	180 to 511	180 to 511	561 to 751	821 to 112	180 to 511	561 to 751	821 to 112
D	7.0 max.	8.5 max.	11.5max.	11.5max.	12.5max.	12.5max.	15.5 max.	16.0max.	16.0max.
H	10.0 max.	11.5 max.	14.0max.	14.5max.	15.5max.	15.5max.	18.5 max.	19.0max.	19.0max.
W	5.0±1.0	5.0±1.0	5.0±1.0	7.5±1.0	7.5±1.0	7.5±1.0	7.5±1.0	7.5±1.0	7.5±1.0
ød	0.60 ^{+0.06} _{-0.05}	0.60 ^{+0.06} _{-0.05}	0.60 ^{+0.06} _{-0.05}	0.80 ^{+0.08} _{-0.05}	0.80 ^{+0.08} _{-0.05}	0.80 ^{+0.08} _{-0.05}	0.80 ^{+0.08} _{-0.05}	0.80 ^{+0.08} _{-0.05}	0.80 ^{+0.08} _{-0.05}
B	4.0±1.0	4.0±1.0	4.0±1.0	4.0±1.0	4.0±1.0	4.0±1.5	4.0±1.0	4.0±1.0	4.0±1.5
Standard Products Part No.	ERZV05D□□□CS	ERZV07D□□□CS	ERZV09D□□□CS	ERZV10D□□□CS	ERZV10D□□□CS	ERZV10D□□□C1	ERZV14D□□□CS	ERZV14D□□□CS	ERZV14D□□□C1

Crimped Leads Cut Type (Bulk Type)

Ratings and Characteristics

※Refer to bulk standard type.

Dimensions in mm (not to scale)

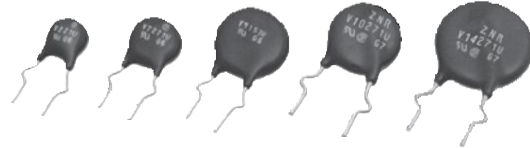
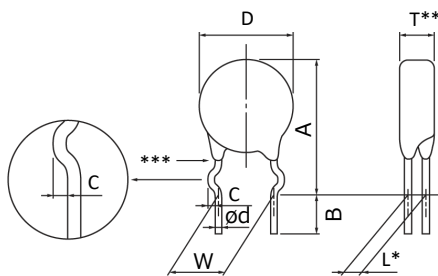

notes * Dimension "L": Conforms to each individual specification.
 ** Dimension "T": Conforms to each individual specification.
 *** Resin extenytions : No resin below the center of the hook.

Unit : mm

Series	5	7	9	10			14		
Varistor Voltage	180 to 471	180 to 511	180 to 511	180 to 511	561 to 751	821 to 112	180 to 511	561 to 751	821 to 112
A	13.0 max.	14.5 max.	17.5 max.	17.5 max.	19.0 max.	20.0 max.	21.0 max.	22.0 max.	23.5 max.
D	7.0 max.	8.5 max.	11.5max.	11.5max.	12.5max.	12.5max.	15.5 max.	16.0max.	16.0max.
C	1.2±0.4	1.2±0.4	1.2±0.4	1.4±0.4	1.4±0.4	1.4±0.4	1.4±0.4	1.4±0.4	1.4±0.4
W	5.0±1.0	5.0±1.0	5.0±1.0	7.5±1.0	7.5±1.0	7.5±1.0	7.5±1.0	7.5±1.0	7.5±1.0
ød	0.60 ^{+0.06} _{-0.05}	0.60 ^{+0.06} _{-0.05}	0.60 ^{+0.06} _{-0.05}	0.80 ^{+0.08} _{-0.05}	0.80 ^{+0.08} _{-0.05}	0.80 ^{+0.08} _{-0.05}	0.80 ^{+0.08} _{-0.05}	0.80 ^{+0.08} _{-0.05}	0.80 ^{+0.08} _{-0.05}
B	4.0±1.0	4.0±1.0	4.0±1.0	4.0±1.0	4.0±1.0	4.0±1.5	4.0±1.0	4.0±1.0	4.0±1.5
Standard Products Part No.	ERZV05V□□□CS	ERZV07V□□□CS	ERZV09V□□□CS	ERZV10V□□□CS	ERZV10V□□□CS	ERZV10V□□□C1	ERZV14V□□□CS	ERZV14V□□□CS	ERZV14V□□□C1

Taping Specifications for Automated Assembly (Straight Leads and Taping)

Ratings and Characteristics

※Refer to bulk standard type.

Dimensions in mm (not to scale)

Type I · II

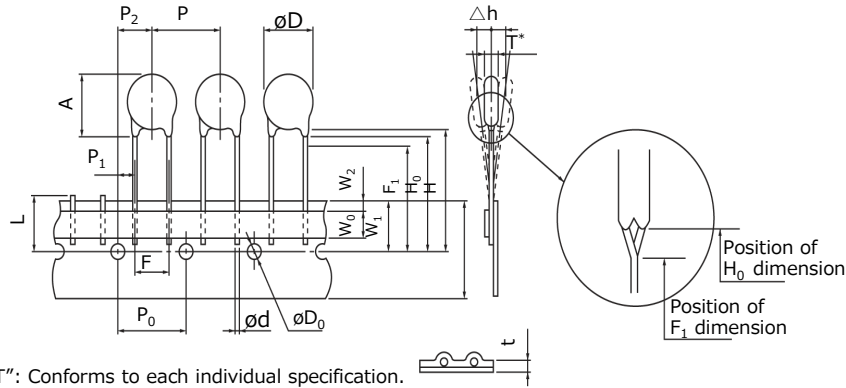

* Dimension "T": Conforms to each individual specification.

Type III · IV

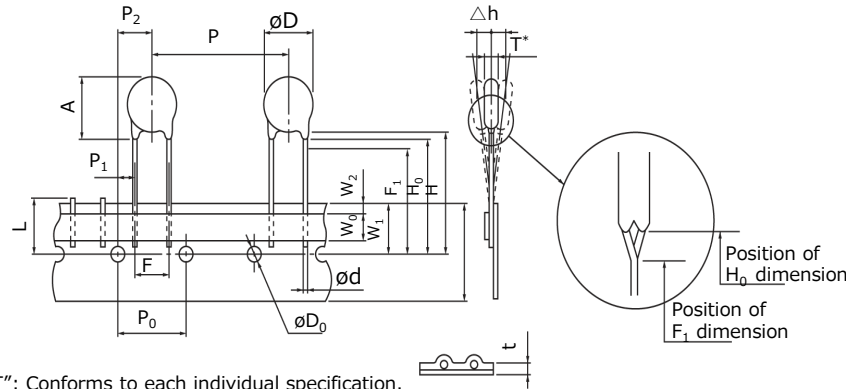

* Dimension "T": Conforms to each individual specification.

Unit : mm

Series	5	7	9	10			14		
Varistor Voltage	180 to 471	180 to 511	180 to 511	180 to 331	361 to 511	561 to 112	180 to 331	361 to 511	561 to 112
Type	Type I	Type I	Type I	Type I	Type II	Type II	type III	Type IV	Type IV
P	12.7±1.0	12.7±1.0	12.7±1.0	15.0±1.0	15.0±1.0	15.0±1.0	30.0±1.0	30.0±1.0	30.0±1.0
P ₀	12.7±0.3	12.7±0.3	12.7±0.3	15.0±0.3	15.0±0.3	15.0±0.3	15.0±0.3	15.0±0.3	15.0±0.3
P ₁	3.85±0.70	3.85±0.70	3.85±0.70	3.75±0.70	3.75±0.70	3.75±0.70	3.75±0.70	3.75±0.70	3.75±0.70
P ₂	6.35±1.30	6.35±1.30	6.35±1.30	7.5±1.3	7.5±1.3	7.5±1.3	7.5±1.3	7.5±1.3	7.5±1.3
ø d	0.60 ^{+0.06} _{-0.05}	0.60 ^{+0.06} _{-0.05}	0.60 ^{+0.06} _{-0.05}	0.80 ^{+0.08} _{-0.05}	0.80 ^{+0.08} _{-0.05}	0.80 ^{+0.08} _{-0.05}	0.80 ^{+0.08} _{-0.05}	0.80 ^{+0.08} _{-0.05}	0.80 ^{+0.08} _{-0.05}
F	5.0±0.5	5.0±0.5	5.0±0.5	7.5±0.5	7.5±0.5	7.5±0.5	7.5±0.5	7.5±0.5	7.5±0.5
Δ h	0±2	0±2	0±2	0±2	0±2	0±2	0±2	0±2	0±2
W	18.0 ^{+1.0} _{-0.5}	18.0 ^{+1.0} _{-0.5}	18.0 ^{+1.0} _{-0.5}	18.0 ^{+1.0} _{-0.5}	18.0 ^{+1.0} _{-0.5}	18.0 ^{+1.0} _{-0.5}	18.0 ^{+1.0} _{-0.5}	18.0 ^{+1.0} _{-0.5}	18.0 ^{+1.0} _{-0.5}
W ₀	5.0 min.	5.0 min.	5.0 min.	5.0 min.	5.0 min.	5.0 min.	5.0 min.	5.0 min.	5.0 min.
W ₁	9.0±0.5	9.0±0.5	9.0±0.5	9.0±0.5	9.0±0.5	9.0±0.5	9.0±0.5	9.0±0.5	9.0±0.5
W ₂	3 max.	3 max.	3 max.	3 max.	3 max.	3 max.	3 max.	3 max.	3 max.
H	Approx. 20	Approx. 20	Approx. 20	Approx. 22	Approx. 22	Approx. 22	Approx. 22	Approx. 22	Approx. 22
H ₀	17.0±0.5	17.0±0.5	17.0±0.5	18.0 ^{+2.0} ₀	—	—	18.0 ^{+2.0} ₀	—	—
F ₁	—	—	—	—	16.00 ^{+0.75} _{-0.5}	16.00 ^{+0.75} _{-0.5}	—	16.00 ^{+0.75} _{-0.5}	16.00 ^{+0.75} _{-0.5}
øD ₀	ø4.0±0.2	ø4.0±0.2	ø4.0±0.2	ø4.0±0.2	ø4.0±0.2	ø4.0±0.2	ø4.0±0.2	ø4.0±0.2	ø4.0±0.2
t	0.6±0.3	0.6±0.3	0.6±0.3	0.6±0.3	0.6±0.3	0.6±0.3	0.6±0.3	0.6±0.3	0.6±0.3
L	11 max.	11 max.	11 max.	11 max.	11 max.	11 max.	11 max.	11 max.	11 max.
øD	7.0 max.	8.5 max.	11.5 max.	11.5 max.	11.5 max.	12.5 max.	15.5 max.	15.5 max.	16.0 max.
A	10.0 max.	11.5 max.	14.0 max.	14.5 max.	14.5 max.	15.5 max.	18.5 max.	18.5 max.	19.0 max.
Standard Products Part No.	ERZVA5D□□□	ERZVA7D□□□	ERZVA9D□□□	ERZVGAD□□□	ERZVGAD□□□	ERZVGAD□□□	ERZVGED□□□	ERZVGED□□□	ERZVGED□□□

Taping Specifications for Automated Assembly (Crimped Leads and Taping)

Ratings and Characteristics

※Refer to bulk standard type.

Dimensions in mm (not to scale)

Type I

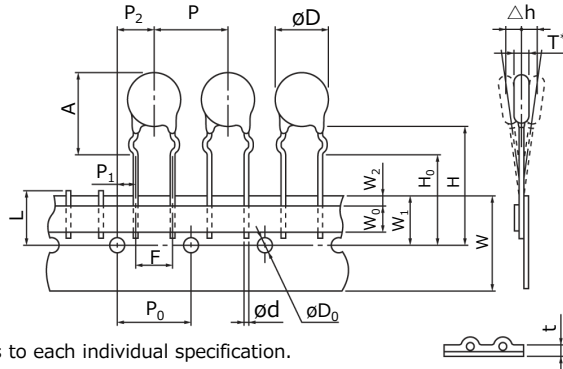

* Dimension "T": Conforms to each individual specification.

Type II

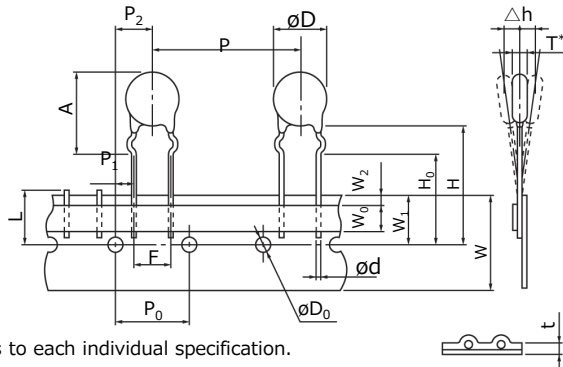

* Dimension "T": Conforms to each individual specification.

Unit : mm

Series	5	7	9	10			14		
Varistor Voltage	180 to 471	180 to 511	180 to 511	180 to 331	361 to 511	561 to 112	180 to 331	361 to 511	561 to 112
Type	Type I	Type I	Type I	Type I	Type I	Type I	Type II	Type II	Type II
P	12.7±1.0	12.7±1.0	12.7±1.0	15.0±1.0	15.0±1.0	15.0±1.0	30.0±1.0	30.0±1.0	30.0±1.0
P ₀	12.7±0.3	12.7±0.3	12.7±0.3	15.0±0.3	15.0±0.3	15.0±0.3	15.0±0.3	15.0±0.3	15.0±0.3
P ₁	3.85±0.70	3.85±0.70	3.85±0.70	3.75±0.70	3.75±0.70	3.75±0.70	3.75±0.70	3.75±0.70	3.75±0.70
P ₂	6.35±1.30	6.35±1.30	6.35±1.30	7.5±1.3	7.5±1.3	7.5±1.3	7.5±1.3	7.5±1.3	7.5±1.3
ød	0.60 ^{+0.06} _{-0.05}	0.60 ^{+0.06} _{-0.05}	0.60 ^{+0.06} _{-0.05}	0.80 ^{+0.08} _{-0.05}	0.80 ^{+0.08} _{-0.05}	0.80 ^{+0.08} _{-0.05}	0.80 ^{+0.08} _{-0.05}	0.80 ^{+0.08} _{-0.05}	0.80 ^{+0.08} _{-0.05}
F	5.0±0.5	5.0±0.5	5.0±0.5	7.5±0.5	7.5±0.5	7.5±0.5	7.5±0.5	7.5±0.5	7.5±0.5
Δh	0±2	0±2	0±2	0±2	0±2	0±2	0±2	0±2	0±2
W	18.0 ^{+1.0} _{-0.5}	18.0 ^{+1.0} _{-0.5}	18.0 ^{+1.0} _{-0.5}	18.0 ^{+1.0} _{-0.5}	18.0 ^{+1.0} _{-0.5}	18.0 ^{+1.0} _{-0.5}	18.0 ^{+1.0} _{-0.5}	18.0 ^{+1.0} _{-0.5}	18.0 ^{+1.0} _{-0.5}
W ₀	5.0 min.	5.0 min.	5.0 min.	5.0 min.	5.0 min.	5.0 min.	5.0 min.	5.0 min.	5.0 min.
W ₁	9.0±0.5	9.0±0.5	9.0±0.5	9.0±0.5	9.0±0.5	9.0±0.5	9.0±0.5	9.0±0.5	9.0±0.5
W ₂	3 max.	3 max.	3 max.	3 max.	3 max.	3 max.	3 max.	3 max.	3 max.
H	Approx. 22	Approx. 22	Approx. 22	Approx. 22	Approx. 22	Approx. 22	Approx. 22	Approx. 22	Approx. 22
H ₀	17.0±0.5	17.0±0.5	17.0±0.5	16.0±0.5	16.0±0.5	16.0±0.5	16.0±0.5	16.0±0.5	16.0±0.5
øD ₀	ø4.0±0.2	ø4.0±0.2	ø4.0±0.2	ø4.0±0.2	ø4.0±0.2	ø4.0±0.2	ø4.0±0.2	ø4.0±0.2	ø4.0±0.2
t	0.6±0.3	0.6±0.3	0.6±0.3	0.6±0.3	0.6±0.3	0.6±0.3	0.6±0.3	0.6±0.3	0.6±0.3
L	11 max.	11 max.	11 max.	11 max.	11 max.	11 max.	11 max.	11 max.	11 max.
øD	7.0 max.	8.5 max.	11.5 max.	11.5 max.	11.5 max.	12.5 max.	15.5 max.	15.5 max.	16.0 max.
A	13.0 max.	14.5 max.	17.5 max.	17.5 max.	17.5 max.	*(refer)	21.0 max.	21.0 max.	*(refer)
Standard Products Part No.	ERZVA5V□□□	ERZVA7V□□□	ERZVA9V□□□	ERZVEAV□□□	ERZVEAV□□□	ERZVEAV□□□	ERZVEEV□□□	ERZVEEV□□□	ERZVEEV□□□

*Dimension "A"

	10 Series	14 Series		10 Series	14 Series
ERZV□□V561	19.0 max.	22.0 max.	ERZV□□V821	20.0 max.	23.5 max.
ERZV□□V621	19.0 max.	22.0 max.	ERZV□□V911	20.0 max.	23.5 max.
ERZV□□V681	19.0 max.	22.0 max.	ERZV□□V102	20.0 max.	23.5 max.
ERZV□□V751	19.0 max.	22.0 max.	ERZV□□V112	20.0 max.	23.5 max.

Application Note for Safety Standards

- Approvals products lists in "Reference Guide to Standard Products."
- UL, VDE and CSA : Registered in "Type name", it isn't registered in "Panasonic Part No."
- CQC : Registered in "Panasonic Part No."
- "Rated Voltages" are specified for UL recognized components in list shown below.

■ The AC Rated Voltage and Maximum Allowable Voltage

Type Name	Maximum Allowable Voltage		Rated Voltage (Vrms)	
	ACrms (V)	DC (V)	UL1449	CSA C22.2 No.269.5
V*820U	50	65	45	N/A
V*101U	60	85	55	N/A
V*121U	75	100	68	N/A
V*151U	95	125	86	N/A
V*201U	130	170	118	118
V*221U	140	180	127	127
V*241U	150	200	136	136
V*271U	175	225	159	159
V*331U	210	270	189	189
V*361U	230	300	209	209
V*391U	250	320	227	227
V*431U	275	350	250	250
V*471U	300	385	272	272
V*511U	320	410	291	291
V*561U	350	450	320	320
V*621U	385	505	350	350
V*681U	420	560	381	381
V*751U	460	615	418	418
V*821U	510	670	463	463
V*911U	550	745	500	500
V*102U	625	825	568	568
V*112U	680	895	600	618
V*182U	1000	1465	600	909

* : 5 Series is blank, 7 series is 7, 9 series is 9, 10 series is 10, 14 series is 14, 20 series is 20

Guidelines and precautions regarding the technical information and use of our products described in this online catalog.

- If you want to use our products described in this online catalog for applications requiring special qualities or reliability, or for applications where the failure or malfunction of the products may directly jeopardize human life or potentially cause personal injury (e.g. aircraft and aerospace equipment, traffic and transportation equipment, combustion equipment, medical equipment, accident prevention, anti-crime equipment, and/or safety equipment), it is necessary to verify whether the specifications of our products fit to such applications. Please ensure that you will ask and check with our inquiry desk as to whether the specifications of our products fit to such applications use before you use our products.
- The quality and performance of our products as described in this online catalog only apply to our products when used in isolation. Therefore, please ensure you evaluate and verify our products under the specific circumstances in which our products are assembled in your own products and in which our products will actually be used.
- If you use our products in equipment that requires a high degree of reliability, regardless of the application, it is recommended that you set up protection circuits and redundancy circuits in order to ensure safety of your equipment.
- The products and product specifications described in this online catalog are subject to change for improvement without prior notice. Therefore, please be sure to request and confirm the latest product specifications which explain the specifications of our products in detail, before you finalize the design of your applications, purchase, or use our products.
- The technical information in this online catalog provides examples of our products' typical operations and application circuits. We do not guarantee the non-infringement of third party's intellectual property rights and we do not grant any license, right, or interest in our intellectual property.
- If any of our products, product specifications and/or technical information in this online catalog is to be exported or provided to non-residents, the laws and regulations of the exporting country, especially with regard to security and export control, shall be observed.

<Regarding the Certificate of Compliance with the EU RoHS Directive/REACH Regulations>

- The switchover date for compliance with the RoHS Directive/REACH Regulations varies depending on the part number or series of our products.
- When you use the inventory of our products for which it is unclear whether those products are compliant with the RoHS Directive/REACH Regulation, please select "Sales Inquiry" in the website inquiry form and contact us.

We do not take any responsibility for the use of our products outside the scope of the specifications, descriptions, guidelines and precautions described in this online catalog.

Varistors (ZNR Surge Absorber) Type D, Series V

Varistors (ZNR Surge Absorber) Type SMD, Series HF, VF

Handling Precautions

Safety Precautions

In case that a Varistors (ZNR Surge Absorber) (hereafter referred to as the ZNR, or product name) is used, if an abnormality takes place because of peripheral conditions of the ZNR(material, environments, power source conditions, circuit conditions, etc. in equipment design), fire, electric shock, burn, or product failure may occur. The precautions for this product are described below, understand the content thoroughly before usage. For more questions, contact us.

If there's any uncertainty/doubt/products safety items, please contact us. When a dogma shall be occurred about safety for this products, be sure to inform us rapidly, operate your technical examination.

1. Precautions to be strictly observed

1.1 Confirmation of performance ratings

Use the ZNR within its rated range of performance such as the Max. allowable voltage, withstanding surge current, withstanding energy, impulse life(surge life), average pulse power, and operating temperature range. If used outside the range, the ZNR can be degrade and have element fracture, which may result in smoking and ignition.

1.2 To avoid accidents due to unexpected phenomena, take the following measures

- 1) In the event of fracture of the ZNR, its pieces may scatter ; hence, put the case or cover of the set product in place.
- 2) Do not install the ZNR near combustible substances(polyvinyl chloride wires, resin moldings, etc.).
If it is difficult to do, install a nonflammable cover.
- 3) Across-the-line use
When the ZNR is used across a line, put a current fuse in series with the ZNR(Refer to Item 2.1.1). (4) .
- 4) Use between line to ground
 - (1) If the case that the ZNR is used between a line to the ground, the short-circuit of the ZNR may not blow the current fuse because of grounding resistance, which may cause smoking and ignition of the ZNR's exterior resin.
As the measure against it, install an earth leakage breaker on the power supply side of the ZNR position. If no earth leakage breaker is installed, use a thermal fuse together with a current fuse in series. (Refer to Table 1.)
 - (2) If the case that the ZNR is used between a live part to metal case, an electric shock may develop at a shortcircuit of the ZNR ; hence, ground the metal case to the ground or keep it from the human body.

1.3 If ZNR is shorted out and happen smoke or ignition, please cut provided current to ZNR immediately.

2. Application notes

2.1 Pay attention to the following items to avoid the shortened life and failure of the ZNR

- 1) Circuit conditions
 - (1) Select a ZNR of which the maximum voltage including fluctuations in source voltage allows for the maximum permissible circuit voltage. (Refer to Table 1.)
 - (2) In cases that surges are intermittently applied at short intervals(for example, in case that the voltage of the noise simulator test is implemented etc.), do not let them exceed the ZNR's rated power.
 - (3) Select a ZNR recommended in Table 1.
<1> Across-the-line use
If possible, use a Part No. marked with * in case of voltage temporarily rises load unbalance of separately-wired loads, short between hot and neutral-line, open of neutral line in single-phase-three-wired system, and due to resonance at switching for a capacitive, inductive load.

<2> Used between line to ground

Use a different Part No. from “Across-the-line use” as table 1, because of raising voltage in case of “Line to Ground Fault”.

Use a Part No. marked with ** in table 1, in case of the insulation resistance test(500 VDC) for equipment. When using a Part of the varistor voltage that the insulation efficiency examination can not be cleared, there is a case where the surge absorber can be done by removing it from the circuit depending on the circuit condition(Refer examination of Japan Domestic Safety Regulations).

Use a Part No. marked with *** in table 1, in case of the withstanding voltage test (1000 VAC or 1200 VAC) for equipment.

(4) Concerning current fuse

<1> We recommend selecting a ZNR and the rated current of a current fuse as follows.

Finally, please be sure that there is no danger if the ZNR mounted on the equipment breaks.

●Type D, Series V

Standard Part No.	ERZV05D□□□	ERZV07D□□□	ERZV09D□□□	ERZV10D□□□	ERZV14D□□□	ERZV20D□□□
Fuse rated current	3 A max.	5 A max.	7 A max.	7 A max.	10 A max.	10 A max.

◆ Fuses shall use rated voltages appropriate for circuits.

●Type SMD, Series VF

Standard Part No.	ERZVF□M□□□
Fuse rated current	5 A max.

◆ Fuses shall use rated voltages appropriate for circuits.

◆ Concerning HF series, please confirm adjusted to load dump surge and protection cooperation.

<2> The recommended fuse position is shown in table 1, “Example of ZNR application”, however, if the load current of protected equipment is larger than that of the above recommended fuse rated current, install a current fuse at the position shown below.

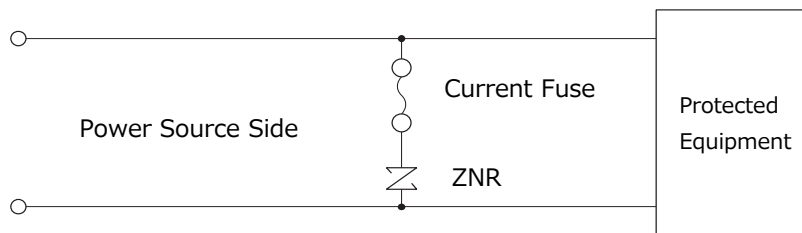

(5) Concerning thermal fuse

Set a thermal fuse to get high thermal

Table 1 Example of ZNR application

Connections example	Across-the-Line use		Use between Line to ground																																																												
	DC/AC Single-phase	AC 3-phase	DC/AC Single-phase	AC 3-phase																																																											
Example of varistor voltage	<table border="1"> <thead> <tr> <th rowspan="2">ZNR</th> <th rowspan="2">Source voltage [AC]</th> <th colspan="2">Nominal varistor voltage</th> </tr> <tr> <th>Type D</th> <th>SMD Mold Type</th> </tr> </thead> <tbody> <tr> <td rowspan="2">ZNR 1</td> <td>100 V</td> <td>201 to 361*</td> <td>201 to 361*</td> </tr> <tr> <td>120 V</td> <td>241 to 431*</td> <td>241 to 431*</td> </tr> <tr> <td rowspan="4">ZNR 3</td> <td>200 V</td> <td>471 to 621*</td> <td>471</td> </tr> <tr> <td>220 V</td> <td>471 to 621*</td> <td>471</td> </tr> <tr> <td>240 V</td> <td>511, 621*</td> <td>-</td> </tr> <tr> <td>380 V</td> <td>821</td> <td>-</td> </tr> </tbody> </table>		ZNR	Source voltage [AC]	Nominal varistor voltage		Type D	SMD Mold Type	ZNR 1	100 V	201 to 361*	201 to 361*	120 V	241 to 431*	241 to 431*	ZNR 3	200 V	471 to 621*	471	220 V	471 to 621*	471	240 V	511, 621*	-	380 V	821	-	<table border="1"> <thead> <tr> <th rowspan="2">ZNR</th> <th rowspan="2">Source voltage [AC]</th> <th colspan="2">Nominal varistor voltage</th> </tr> <tr> <th>Type D</th> <th>SMD Mold Type</th> </tr> </thead> <tbody> <tr> <td rowspan="4">ZNR 2</td> <td rowspan="4">100 V 220 V</td> <td>471</td> <td>471</td> </tr> <tr> <td>511</td> <td>-</td> </tr> <tr> <td>621*</td> <td>-</td> </tr> <tr> <td>821 and more**</td> <td>-</td> </tr> <tr> <td rowspan="5">ZNR 4</td> <td rowspan="3">230 V 240 V</td> <td>182***</td> <td>-</td> </tr> <tr> <td>511</td> <td>-</td> </tr> <tr> <td>621*</td> <td>-</td> </tr> <tr> <td rowspan="2">380 V</td> <td>821 and more**</td> <td>-</td> </tr> <tr> <td>112**</td> <td>-</td> </tr> <tr> <td></td> <td></td> <td>182***</td> <td>-</td> </tr> </tbody> </table>		ZNR	Source voltage [AC]	Nominal varistor voltage		Type D	SMD Mold Type	ZNR 2	100 V 220 V	471	471	511	-	621*	-	821 and more**	-	ZNR 4	230 V 240 V	182***	-	511	-	621*	-	380 V	821 and more**	-	112**	-			182***	-
	ZNR	Source voltage [AC]			Nominal varistor voltage																																																										
Type D			SMD Mold Type																																																												
ZNR 1	100 V	201 to 361*	201 to 361*																																																												
	120 V	241 to 431*	241 to 431*																																																												
ZNR 3	200 V	471 to 621*	471																																																												
	220 V	471 to 621*	471																																																												
	240 V	511, 621*	-																																																												
	380 V	821	-																																																												
ZNR	Source voltage [AC]	Nominal varistor voltage																																																													
		Type D	SMD Mold Type																																																												
ZNR 2	100 V 220 V	471	471																																																												
		511	-																																																												
		621*	-																																																												
		821 and more**	-																																																												
ZNR 4	230 V 240 V	182***	-																																																												
		511	-																																																												
		621*	-																																																												
	380 V	821 and more**	-																																																												
		112**	-																																																												
		182***	-																																																												

Note : Element size is selected by impulse Condition.

(6) On use for equipment

The catalog guarantees the quality as individual component.
Before you use the products, please make sure to check and evaluate the products in the circumstance where they are installed in your product.

2) Operating environments

- (1) The ZNR is designed to be used indoors. Do not use it exposed outdoors.
- (2) Do not use the ZNR in places exposed to temperatures beyond the operating temperature range, such as places exposed to sunlight and vicinities of heating equipment.
- (3) Do not use the ZNR in places exposed to high temperatures and high humidity, such as places exposed directly to rain, wind, dew condensation, and vapor.
- (4) Do not use the ZNR in dusty and salinity environment and atmospheres polluted by corrosive gases, in liquids such as water, oil, chemical, organic solvent.

3) Processing conditions

- (1) Do not wash the ZNR by such solvents(thinner, acetone, etc.) as its exterior resin deteriorates.
- (2) Do not apply a strong vibration or shock (by falling, etc.) to the ZNR, cracking to its exterior resin and element may occur.
- (3) When coating the ZNR with resin(including molding), do not use such resin.
- (4) Do not bend the ZNR type D lead wires at the position close to its ZNR type D exterior resin, or apply external force to the position.
- (5) When soldering the ZNR lead wires, follow the recommended conditions and do not melt the solder and insulating materials constituting the ZNR.

	Soldering Method	Recommended Condition	Attention Item
Type D	Flow soldering	260 °C, within 10 seconds.	Type D is not Reflow soldering object part.
SMD Type	Flow soldering	260 °C, within 10 seconds.	When the package density of the part is high pill out gas because the solderability sometimes becomes bad.
	Reflow soldering	Refer to Reflow soldering profile	When Land is too big compared with the size of the terminal surface of the part, be careful because the part sometimes upset when solder fuses.

- * 1 Soldering iron temperature should not exceed 400 °C and should not be applied for more than 5 seconds.
- * 2 Profile be careful because there is a margin of error in the way of measuring.
- * 3 The temperature depend on the size and the package density of the substrate.
Therefore, confirm every kind of the substrate.

● Soldering temperature-time profile to recommend

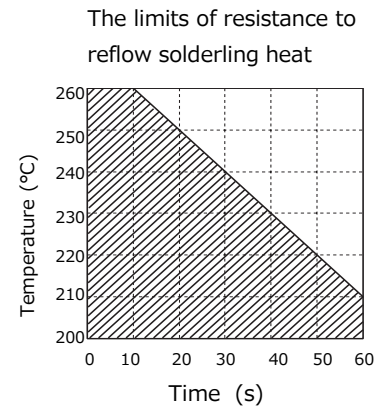
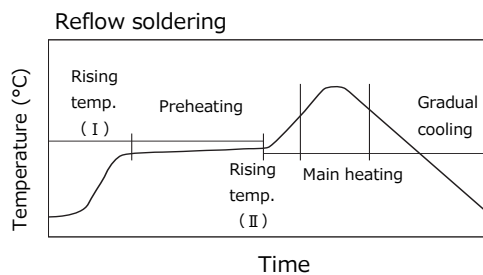
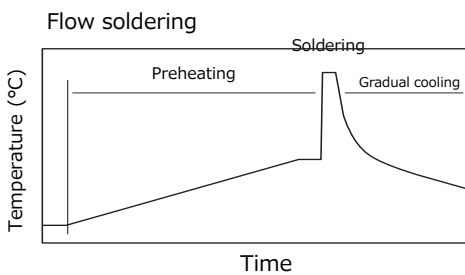

Preheating	The normal to 130 °C	max. 120 s
Soldering	max. 260 °C	max. 10 s
Gradual cooling	Gradual cooling	

Rising temperature I	The normal to preheating temperature	30 to 60 s
Preheating	150 °C to 180 °C	60 to 120 s
Rising temperature II	Preheating to 200 °C	2 to 6 °C / s
Main heating	(cf. The limit of resistance to reflow soldering heat)	
Gradual cooling	200 °C to 100 °C	1 to 4 °C / s

(Reflow soldering shall be within two times)

(6) Lead-wire terminal land-hole (only for Type D)

When designing lead-wire-terminal land-hole of circuit board, please check actual ZNR by reference specification about center value of lead-wire terminal pitch.

(7) Mounting (only for Type SMD)

In case of mounting ZNR on a Printed Circuit Board, be careful not to put excessive impact load, such as pressure from adsorption nozzle, and mechanical impact/stress of position-shifting or positioning. Also, we recommend you to fix a Printed Circuit Board to sheathing resin with an adhesive in case of position-shifting of ZNR when mounting.

4) Long-term storage

- (1) Do not store the ZNR under high temperature and high humidity. Store it indoor environment at a temperature up to 40 °C and at humidity below 75 %RH, and use it within two years.
Before using the ZNR that has been stored for a long period(two years or longer), confirm the solderability.
- (2) Avoid atmospheres full of corrosive gases (hydrogen sulfide, sulfurous acid, chlorine, ammonia, etc.).
- (3) Avoid direct sunlight and dew condensation.

5) Rated Voltage for UL or other safety certifications

Our ZNR define " Max. Allowable Voltage" and "Rated Voltage " to keep leakage current specification and others. If you getting certificate of safety approval about your equipment with our ZNR, please follow our "Rated Voltage".

6) Dropped product

Do not drop this product on the floor. If this product is dropped, it can be damaged mechanically or electrically. Avoid using the dropped product.

3. Notices

- 3.1 Our ZNR was designed and manufactured for standard applications such as general electronics devices, office equipment, information and communications equipment, measuring instruments, household appliances and audio-video equipment. For applications in which special quality and reliability are required, or if the failure or malfunction of the products may directly jeopardize life or cause threat of personal injury (such as for aircraft and aerospace equipment, traffic and transport equipment, combustion equipment, medical equipment, accident prevention and anti-theft devices, and safety equipment), please be sure to consult with our sales representative in advance and to exchange product specifications which conform to such applications. applications in which special quality and reliability are required, or if the failure or malfunction of the products may.
- 3.2 Note that we do not take any responsibility for faults and abnormalities resulting from the use not in conformity with the contents of entries in the delivery specification.
- 3.3 There is a possibility that the ZNR will unexpectedly cause smoke or ignite because of an abnormal rise of the circuit voltage and invasion of excessive surge. To prevent that accident from spreading over the equipment and not to expand the damage, use multiplex protection such as the adoption of flame-retardant materials for housing parts and structural parts.

4. Applicable laws and regulations , others

- 4.1 This product not been manufactured with any ozone depleting chemical controlled under the Montreal Protocol.
- 4.2 This product comply with RoHS(Restriction of the use of certain Hazardous Substance in electrical and electronic equipment) (DIRECTIVE 2011/65/EU and (EU)2015/863).
- 4.3 All the materials used in this part are registered material under the Law Concerning the Examination and Regulation of Manufacture, etc. of Chemical Substance.
- 4.4 If you need the notice by letter of "A preliminary judgement on the Laws of Japan foreign exchange and Foreign Trade Control", be sure to let us know.
- 4.5 These products are not dangerous goods on the transportation as identified by UN(United nations) numbers or UN classification.

5. Others

- 5.1 As to the disposal of ZNR, check the method of disposal in each country or origin where the ZNR are incorporated in your products to be used.
- 5.2 The technical information in this specification provides example of our products' typical operations and application circuit. We do not guarantee the non-infringement of third party's intellectual property rights and we do not grant any license, right or interest in our intellectual property.

6. AEC-Q200 Compliant (Type SMD, Series HF)

The products are tested based on all or part of the test conditions and methods defined in AEC-Q200. Please consult with Panasonic for the details of the product specification and specific evaluation test results, etc., and please review and approve Panasonic's product specification before ordering.