

PNP Silicon AF Transistors

- For AF input stages and driver applications
- High current gain
- Low collector-emitter saturation voltage
- Low noise between 30 Hz and 15 kHz
- Complementary types:
 - BC846W, BC847W, BC848W
 - BC849W, BC850W (NPN)

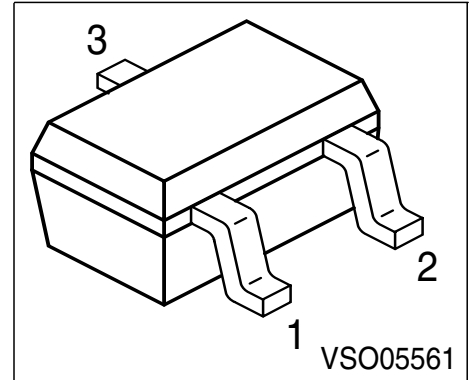

| Type | Marking | Pin Configuration | | | Package |
|---------|---------|-------------------|-------|-------|---------|
| BC856AW | 3As | 1 = B | 2 = E | 3 = C | SOT323 |
| BC856BW | 3Bs | 1 = B | 2 = E | 3 = C | SOT323 |
| BC857AW | 3Es | 1 = B | 2 = E | 3 = C | SOT323 |
| BC857BW | 3Fs | 1 = B | 2 = E | 3 = C | SOT323 |
| BC857CW | 3Gs | 1 = B | 2 = E | 3 = C | SOT323 |
| BC858AW | 3Js | 1 = B | 2 = E | 3 = C | SOT323 |
| BC858BW | 3Ks | 1 = B | 2 = E | 3 = C | SOT323 |
| BC858CW | 3Ls | 1 = B | 2 = E | 3 = C | SOT323 |
| BC859AW | 4As | 1 = B | 2 = E | 3 = C | SOT323 |
| BC859BW | 4Bs | 1 = B | 2 = E | 3 = C | SOT323 |
| BC859CW | 4Cs | 1 = B | 2 = E | 3 = C | SOT323 |
| BC860BW | 4Fs | 1 = B | 2 = E | 3 = C | SOT323 |
| BC860CW | 4Gs | 1 = B | 2 = E | 3 = C | SOT323 |

Maximum Ratings

| Parameter | Symbol | BC856W | BC857W | BC858W | Unit |
|--|-----------|-------------|--------|--------|------|
| | | | BC860W | BC859W | |
| Collector-emitter voltage | V_{CEO} | 65 | 45 | 30 | V |
| Collector-base voltage | V_{CBO} | 80 | 50 | 30 | |
| Collector-emitter voltage | V_{CES} | 80 | 50 | 30 | |
| Emitter-base voltage | V_{EBO} | 5 | 5 | 5 | |
| DC collector current | I_C | 100 | | | mA |
| Peak collector current | I_{CM} | 200 | | | mA |
| Peak base current | I_{BM} | 200 | | | |
| Peak emitter current | I_{EM} | 200 | | | |
| Total power dissipation, $T_S = 124\text{ °C}$ | P_{tot} | 250 | | | mW |
| Junction temperature | T_j | 150 | | | °C |
| Storage temperature | T_{stg} | -65 ... 150 | | | |

Thermal Resistance

| | | | |
|--|------------|------|-----|
| Junction - soldering point ¹⁾ | R_{thJS} | ≤105 | K/W |
|--|------------|------|-----|

Electrical Characteristics at $T_A = 25\text{ °C}$, unless otherwise specified.

| Parameter | Symbol | Values | | | Unit |
|---|---------------|--------|------|------|------|
| | | min. | typ. | max. | |
| DC Characteristics | | | | | |
| Collector-emitter breakdown voltage $I_C = 10\text{ mA}$, $I_B = 0$ | $V_{(BR)CEO}$ | | | | V |
| BC856W | 65 | - | - | | |
| BC857/860W | 45 | - | - | | |
| BC858/859W | 30 | - | - | | |
| Collector-base breakdown voltage $I_C = 10\text{ }\mu\text{A}$, $I_E = 0$ | $V_{(BR)CBO}$ | | | | |
| BC856W | 80 | - | - | | |
| BC857/860W | 50 | - | - | | |
| BC858/859W | 30 | - | - | | |

¹⁾For calculation of R_{thJA} please refer to Application Note Thermal Resistance

Electrical Characteristics at $T_A = 25^\circ\text{C}$, unless otherwise specified.

| Parameter | Symbol | Values | | | Unit | |
|---|---------------|--------------------------|------|------|------|---------------|
| | | min. | typ. | max. | | |
| DC Characteristics | | | | | | |
| Collector-emitter breakdown voltage $I_C = 10 \mu\text{A}$, $V_{BE} = 0$ | $V_{(BR)CES}$ | BC856W | 80 | - | - | V |
| | | BC857/860W | 50 | - | - | |
| | | BC858/859W | 30 | - | - | |
| Emitter-base breakdown voltage $I_E = 1 \mu\text{A}$, $I_C = 0$ | $V_{(BR)EBO}$ | | 5 | - | - | |
| Collector cutoff current $V_{CB} = 30 \text{ V}$, $I_E = 0$ | I_{CBO} | | - | - | 15 | nA |
| Collector cutoff current $V_{CB} = 30 \text{ V}$, $I_E = 0$, $T_A = 150^\circ\text{C}$ | I_{CBO} | | - | - | 5 | μA |
| DC current gain 1) $I_C = 10 \mu\text{A}$, $V_{CE} = 5 \text{ V}$ | h_{FE} | h_{FE} -group A | - | 140 | - | - |
| | | h_{FE} -group B | - | 250 | - | |
| | | h_{FE} -group C | - | 480 | - | |
| DC current gain 1) $I_C = 2 \text{ mA}$, $V_{CE} = 5 \text{ V}$ | h_{FE} | h_{FE} -group A | 125 | 180 | 250 | |
| | | h_{FE} -group B | 220 | 290 | 475 | |
| | | h_{FE} -group C | 420 | 520 | 800 | |
| Collector-emitter saturation voltage1) $I_C = 10 \text{ mA}$, $I_B = 0.5 \text{ mA}$ $I_C = 100 \text{ mA}$, $I_B = 5 \text{ mA}$ | V_{CEsat} | | - | 75 | 300 | mV |
| | | | - | 250 | 650 | |
| Base-emitter saturation voltage 1) $I_C = 10 \text{ mA}$, $I_B = 0.5 \text{ mA}$ $I_C = 100 \text{ mA}$, $I_B = 5 \text{ mA}$ | V_{BEsat} | | - | 700 | - | |
| | | | - | 850 | - | |
| Base-emitter voltage 1) $I_C = 2 \text{ mA}$, $V_{CE} = 5 \text{ V}$ $I_C = 10 \text{ mA}$, $V_{CE} = 5 \text{ V}$ | $V_{BE(ON)}$ | | 600 | 650 | 750 | |
| | | | - | - | 820 | |

 1) Pulse test: $t \leq 300 \mu\text{s}$, $D = 2\%$

Electrical Characteristics at $T_A = 25\text{ °C}$, unless otherwise specified.

| Parameter | Symbol | Values | | | Unit |
|--|-----------|--------|------|------|---------------|
| | | min. | typ. | max. | |
| AC characteristics | | | | | |
| Transition frequency $I_C = 20\text{ mA}$, $V_{CE} = 5\text{ V}$, $f = 100\text{ MHz}$ | f_T | - | 250 | - | MHz |
| Collector-base capacitance $V_{CB} = 10\text{ V}$, $f = 1\text{ MHz}$ | C_{cb} | - | 3 | 5 | pF |
| Emitter-base capacitance $V_{EB} = 0.5\text{ V}$, $f = 1\text{ MHz}$ | C_{eb} | - | 10 | 15 | |
| Short-circuit input impedance $I_C = 2\text{ mA}$, $V_{CE} = 5\text{ V}$, $f = 1\text{ kHz}$ | h_{11e} | | | | k Ω |
| $h_{FE}\text{-gr. A}$ | - | 2.7 | - | | |
| $h_{FE}\text{-gr. B}$ | - | 4.5 | - | | |
| $h_{FE}\text{-gr. C}$ | - | 8.7 | - | | |
| Open-circuit reverse voltage transf.ratio $I_C = 2\text{ mA}$, $V_{CE} = 5\text{ V}$, $f = 1\text{ kHz}$ | h_{12e} | | | | 10^{-4} |
| $h_{FE}\text{-gr. A}$ | - | 1.5 | - | | |
| $h_{FE}\text{-gr. B}$ | - | 2 | - | | |
| $h_{FE}\text{-gr. C}$ | - | 3 | - | | |
| Short-circuit forward current transf.ratio $I_C = 2\text{ mA}$, $V_{CE} = 5\text{ V}$, $f = 1\text{ kHz}$ | h_{21e} | | | | - |
| $h_{FE}\text{-gr. A}$ | - | 200 | - | | |
| $h_{FE}\text{-gr. B}$ | - | 330 | - | | |
| $h_{FE}\text{-gr. C}$ | - | 600 | - | | |
| Open-circuit output admittance $I_C = 2\text{ mA}$, $V_{CE} = 5\text{ V}$, $f = 1\text{ kHz}$ | h_{22e} | | | | μS |
| $h_{FE}\text{-gr. A}$ | - | 18 | - | | |
| $h_{FE}\text{-gr. B}$ | - | 30 | - | | |
| $h_{FE}\text{-gr. C}$ | - | 60 | - | | |
| Noise figure $I_C = 200\text{ }\mu\text{A}$, $V_{CE} = 5\text{ V}$, $R_S = 2\text{ k}\Omega$, $f = 1\text{ kHz}$, $\Delta f = 200\text{ Hz}$ | F | - | - | 10 | dB |
| BC856W | | | | | |
| BC857W | | | | | |
| BC858W | | | | | |
| Noise figure $I_C = 200\text{ }\mu\text{A}$, $V_{CE} = 5\text{ V}$, $R_S = 2\text{ k}\Omega$, $f = 1\text{ kHz}$, $\Delta f = 200\text{ Hz}$ | F | | | | |
| BC859W | - | 1 | 4 | | |
| BC860W | - | 1 | 4 | | |
| | | | | | |
| Equivalent noise voltage $I_C = 200\text{ }\mu\text{A}$, $V_{CE} = 5\text{ V}$, $R_S = 2\text{ k}\Omega$, $f = 10 \dots 50\text{ Hz}$ | V_n | - | - | 0.11 | μV |

Total power dissipation $P_{tot} = f(T_S)$

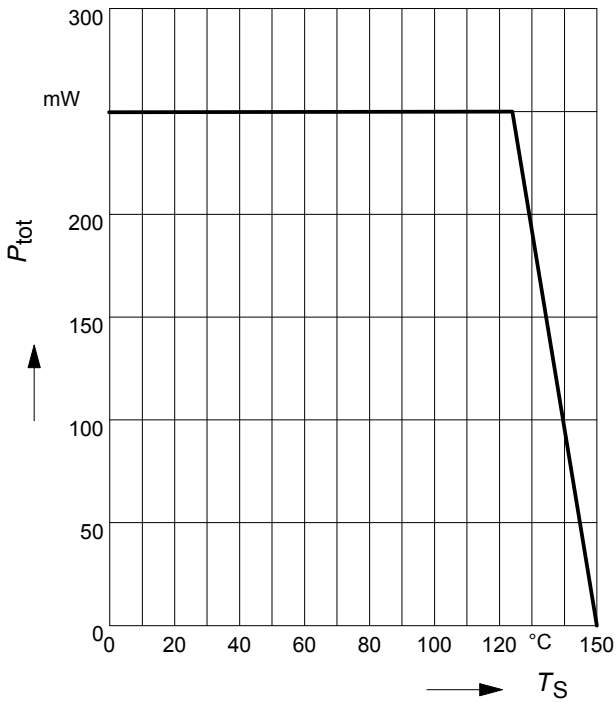

**Collector-base capacitance $C_{CB} = f(V_{CBO})$
Emitter-base capacitance $C_{EB} = f(V_{EBO})$**

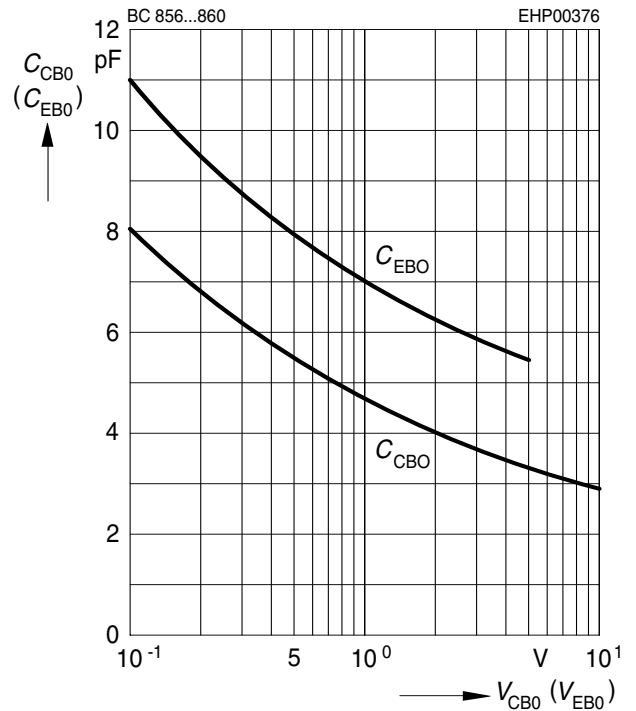

Permissible pulse load

$P_{totmax} / P_{totDC} = f(t_p)$

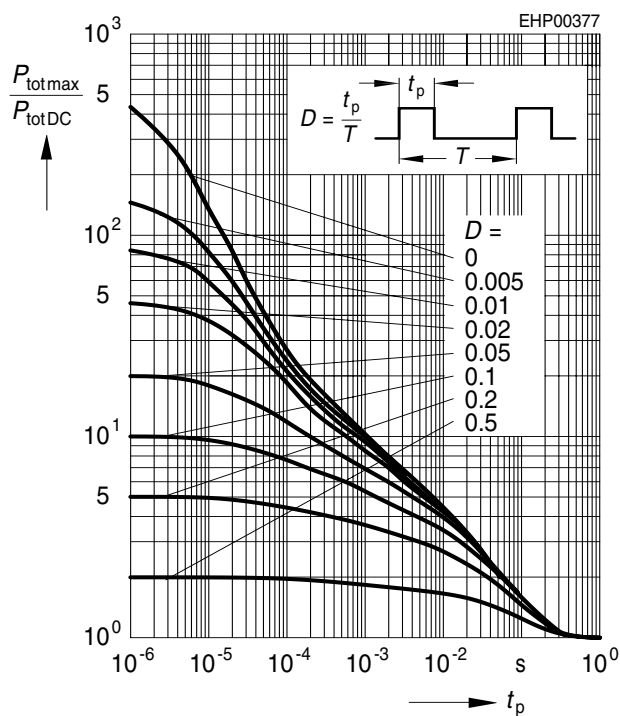

Transition frequency $f_T = f(I_C)$

$V_{CE} = 5V$

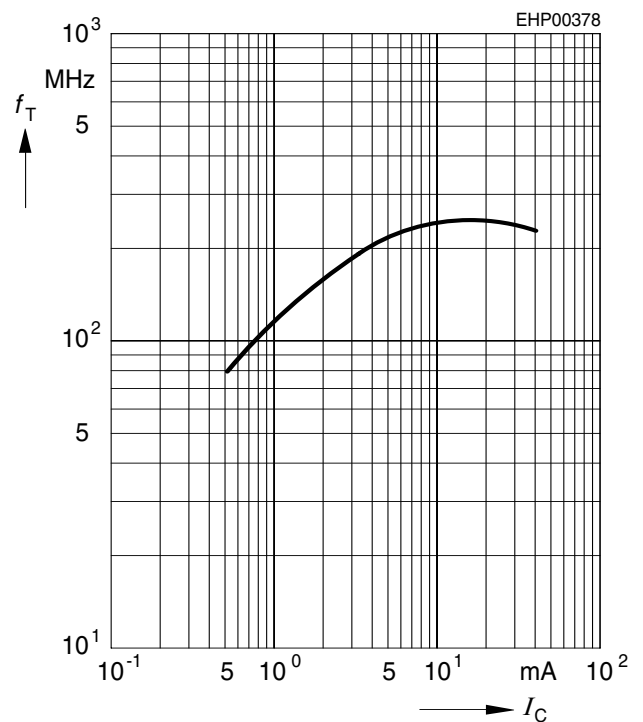

Collector cutoff current $I_{CBO} = f(T_A)$

$V_{CB} = 30V$

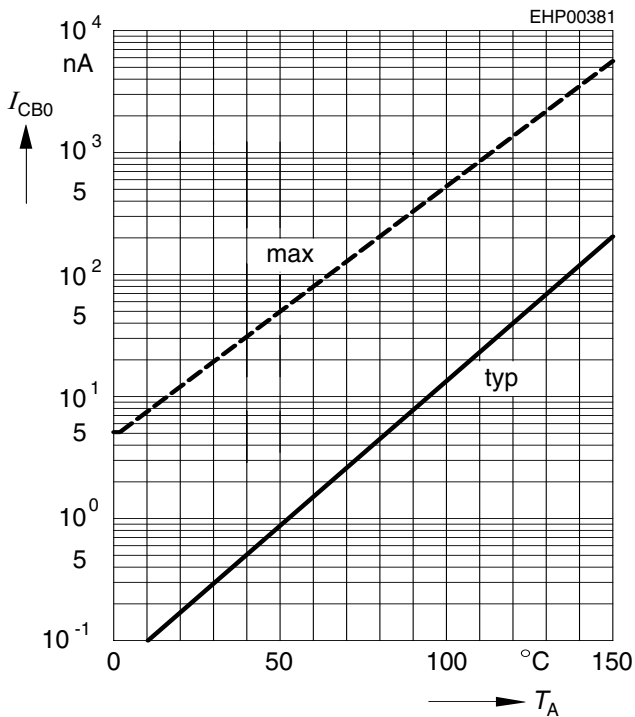

Collector-emitter saturation voltage

$I_C = f(V_{CEsat}), h_{FE} = 20$

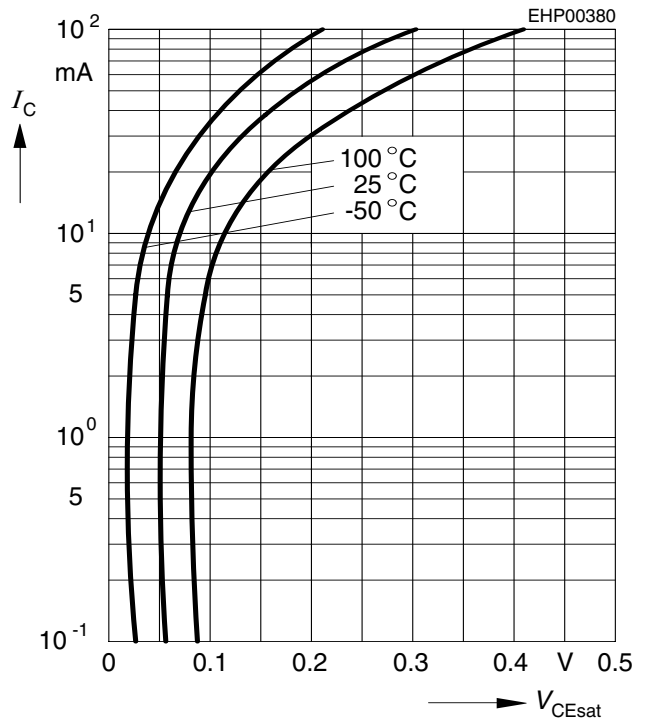

DC current gain $h_{FE} = f(I_C)$

$V_{CE} = 5V$

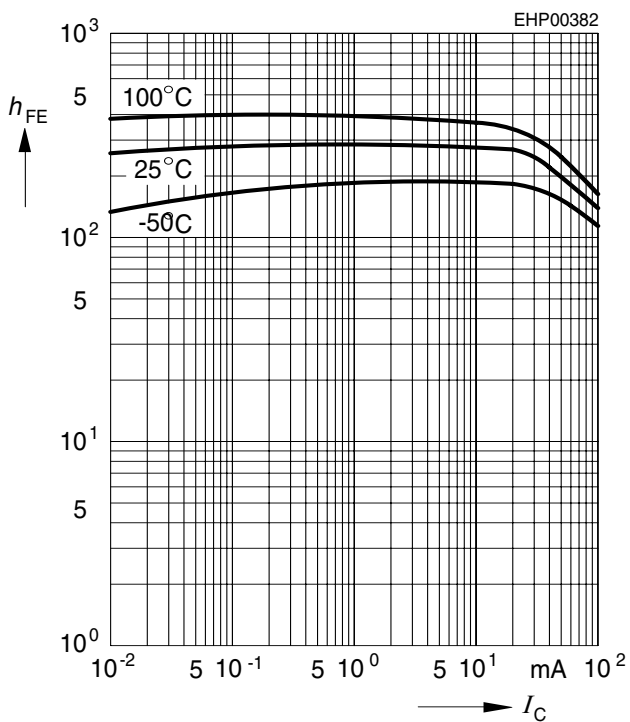

Base-emitter saturation voltage

$I_C = f(V_{BEsat}), h_{FE} = 20$

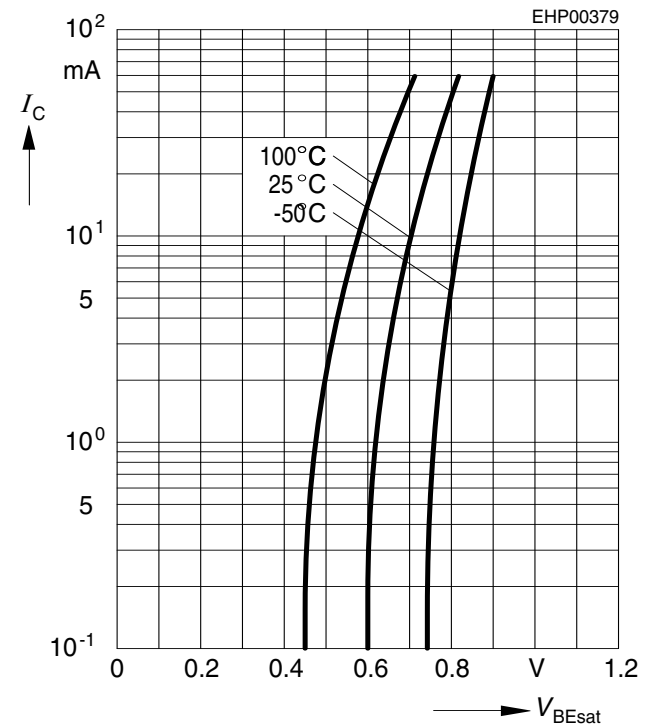

h parameter $h_e = f(I_C)$ normalized

$V_{CE} = 5V$

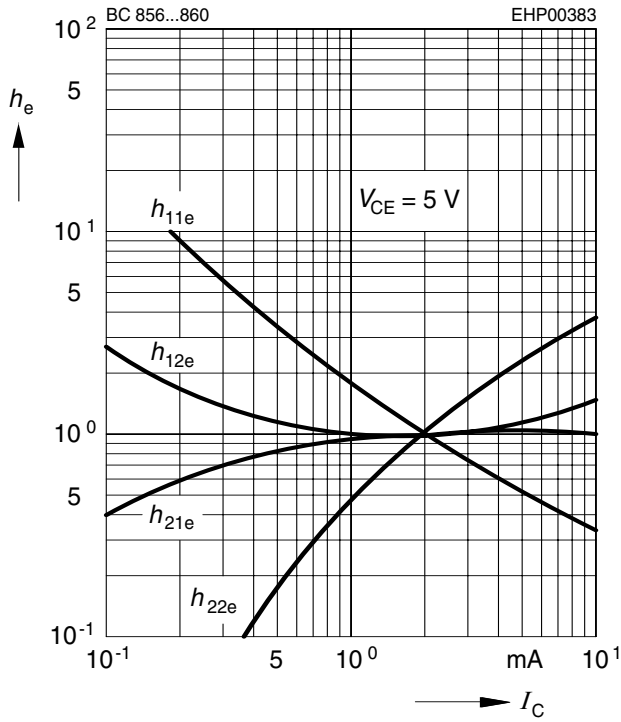

h parameter $h_e = f(V_{CE})$ normalized

$I_C = 2mA$

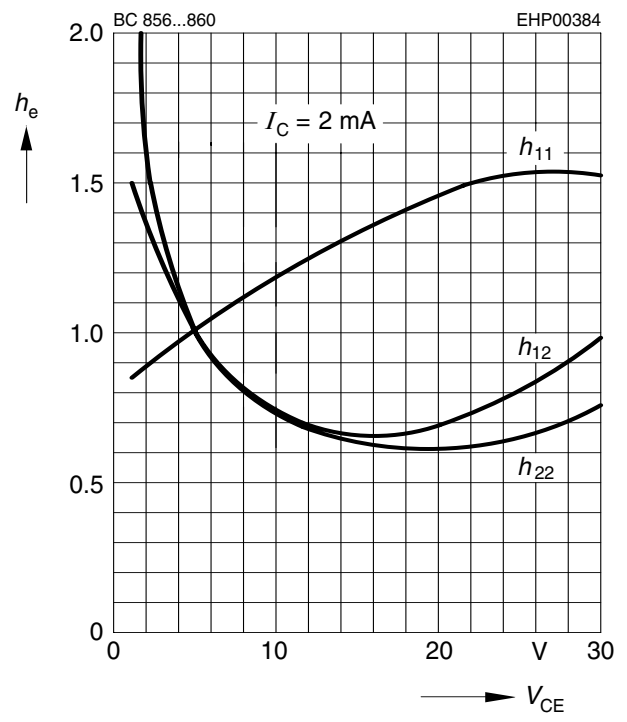

Noise figure $F = f(V_{CE})$

$I_C = 0.2mA$, $R_S = 2k\Omega$, $f = 1kHz$

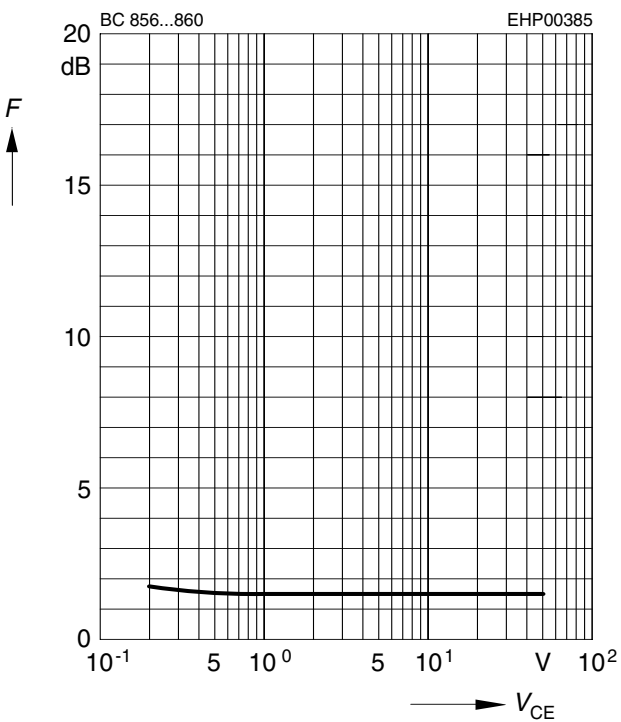

Noise figure $F = f(f)$

$I_C = 0.2mA$, $V_{CE} = 5V$, $R_S = 2k\Omega$

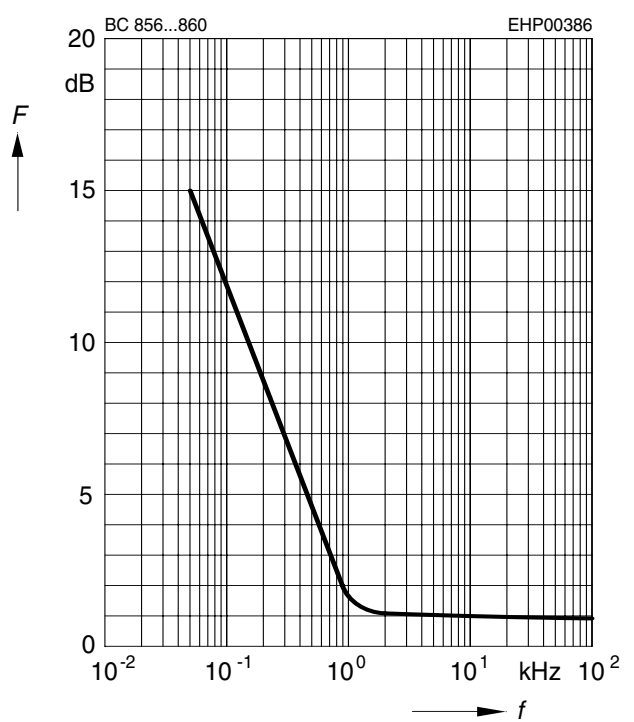

Noise figure $F = f(I_C)$

$V_{CE} = 5V, f = 120Hz$

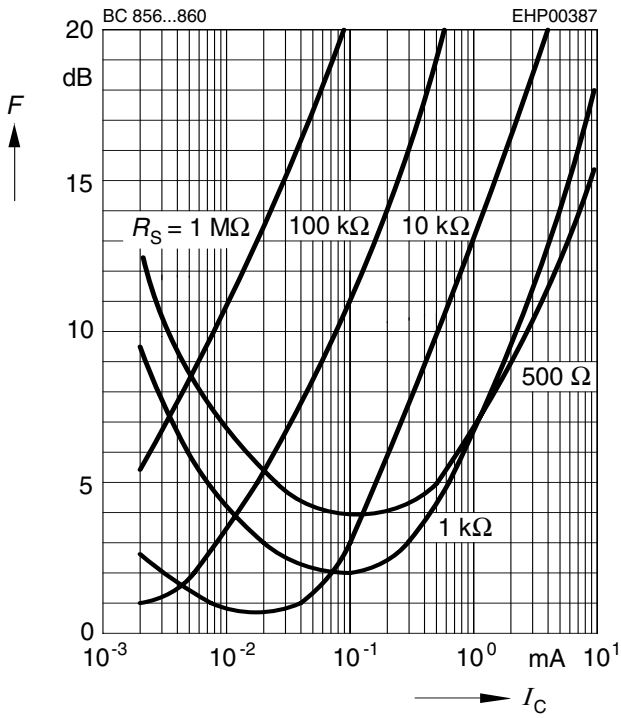

Noise figure $F = f(I_C)$

$V_{CE} = 5V, f = 1kHz$

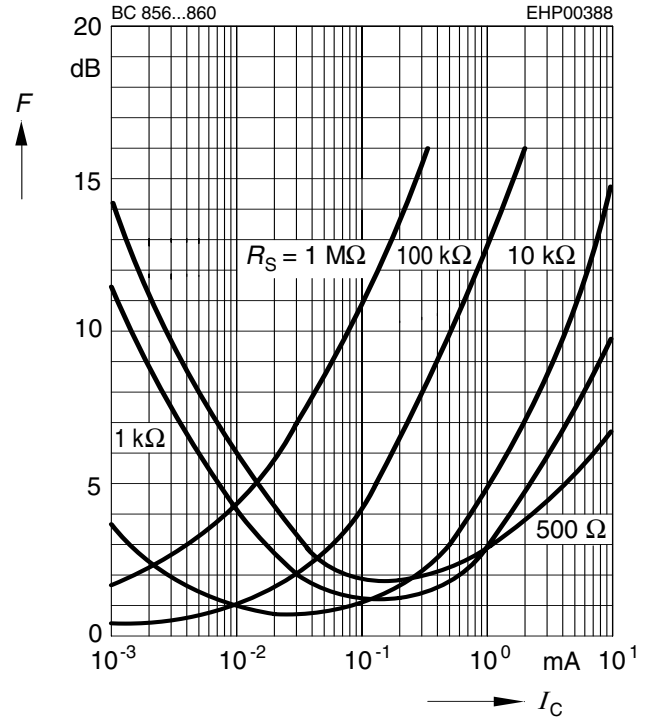

Noise figure $F = f(I_C)$

$V_{CE} = 5V, f = 10kHz$

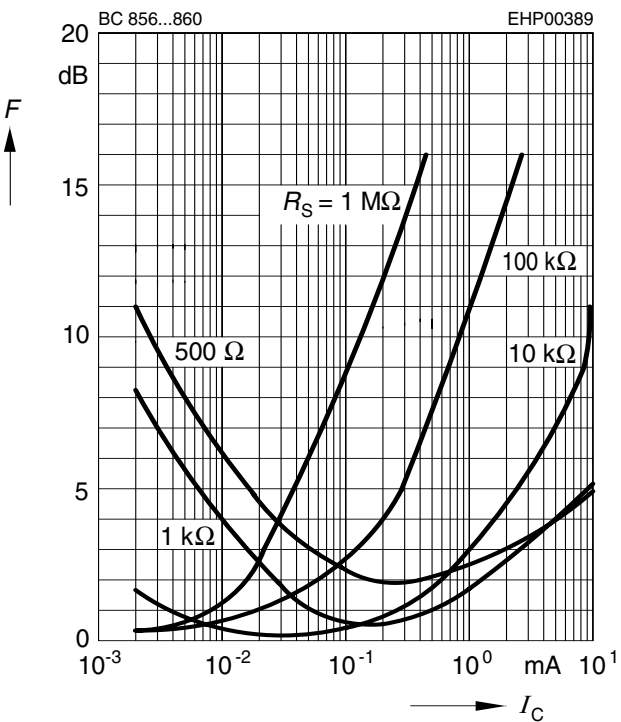

This datasheet has been download from:

www.datasheetcatalog.com

Datasheets for electronics components.