



Feature -

Function selection of multi-position products
Signal selection of audios

Applications -

Audio, public audio system

► SPECIFICATIONS

SWITCH SPECIFICATIONS	
POLE - POSITION	Function selection of multi-position products
CONTACT RATING	125 V AC , 0.3 A
CONTACT RESISTANCE	30 mΩ Max . on DC 5V 1A Measured by Voltage Decreasing Method or Measured by 1 KHZ 2 mV Max .
INSULATION RESISTANCE	100 MΩ min . 500 V DC for 1 minute
DIELECTRIC STRENGTH	Breakdown is not Allowable ; 500 V AC for 1 Minute
ROTATION TORQUE	1.0 ± 0.5 kgf.cm
OPERATING LIFE	10,000 cycles
OPERATING TEMPERATURE RANGE	-20°C ~ 70°C

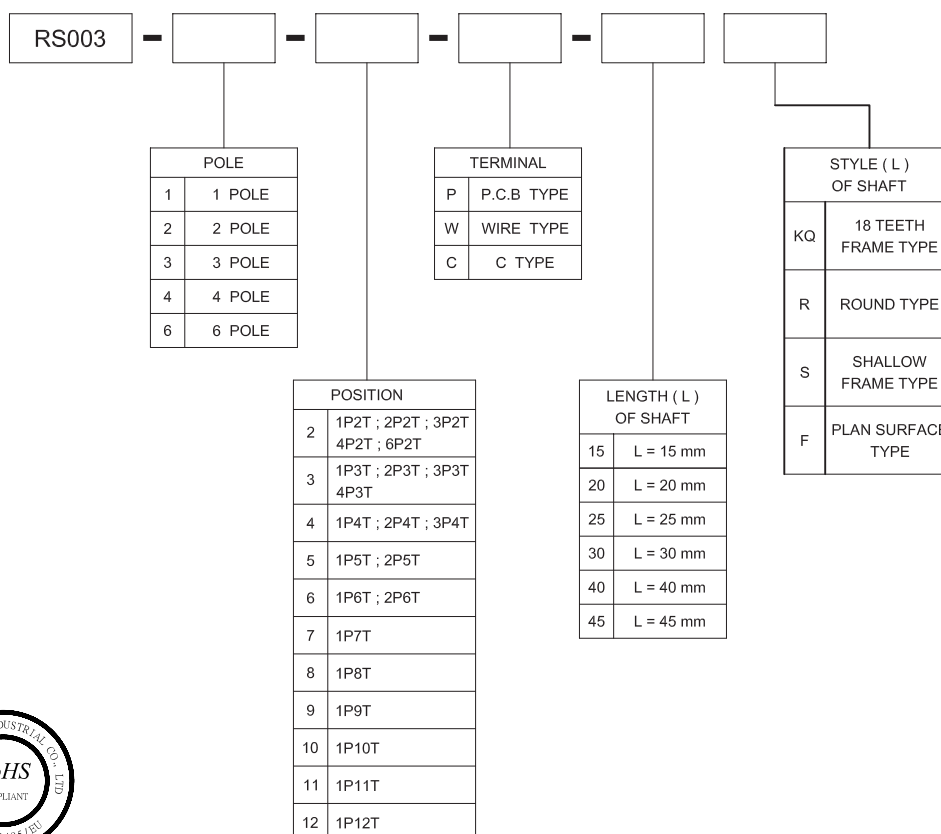

► HOW TO ORDER



RS003 SERIES

ROTARY SWITCH

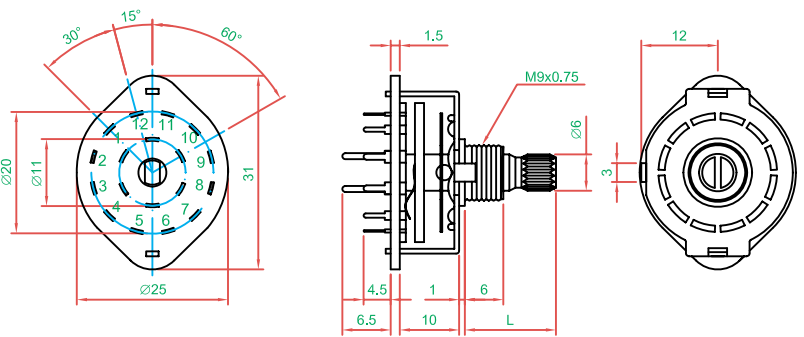
► DIMENSION

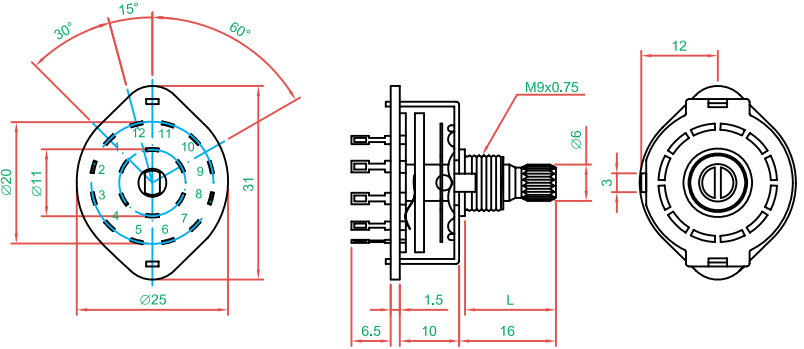
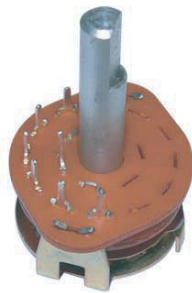
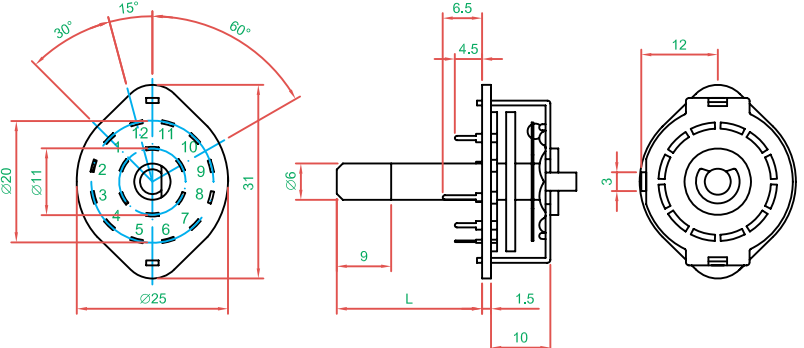
RS003 - 2 - 6 - P - □KQ		 	
RS003 - 2 - 6 - W - □KQ		 	
RS003 - 1 - 6 - C - □F		 	

► SHAFT

KQ	18 TEETH FRAME TYPE	R	ROUND TYPE	S	SHALLOW FRAME TYPE	F	PLAN SURFACE TYPE
	