

**Bullet Type LED lamp**
**BL-L324**
**■ Features:**

- 3.0mm Round Bullet Type LED Lamps
- Ultra brightness.
- Choice of various viewing angles.
- Diffused, Transparent and Water clear lens
- IC compatible /Low current capability.
- RoHs Compliance

**■ Electrical-optical characteristics: (Ta=25°C) (Test Condition: IF=20mA)**

Part Number	Chip			Lens Type	Forward Voltage(VF) Unit:V		Luminous Intensity (lv) Unit:mcd		Viewing Angle 2θ1/2(deg)
	Emitted Color	Material	λ <sub>p</sub> (nm)		Typ	Max	Min.	Typ.	
BL-L324SRC	Hi Red	AlGaAs,SH	660	Water Clear	1.85	2.20	100	440	13
BL-L324LRC	Super Red	AlGaAs,DH	660		1.85	2.20	400	1000	
BL-L324URC	Ultra Red	AlGaAs,DDH	660		1.95	2.20	700	1800	
BL-L324UEC	Ultra Orange	AlGaInP	630		2.10	2.50	1200	2500	
BL-L324UYC	Ultra Yellow	AlGaInP	590		2.10	2.50	500	2000	
BL-L324UGC	Ultra Green	AlGaInP	574		2.20	2.50	800	1800	
BL-L324PGC	Ultra Pure Green	InGaN	525		3.80	4.50	2000	5000	
BL-L324BGC	Ultra Bluish Green	InGaN	505		3.80	4.50	1200	4500	
BL-L324BC	Blue	InGaN	430		3.80	4.50	700	1800	
BL-L324UBC	Ultra Blue	InGaN	470		2.70	4.20	2000	4000	
BL-L324VC	UV	InGaN	405		3.80	4.50	150	220	
BL-L324UWC	Ultra White	InGaN	/		2.70	4.20	3000	10000	

**■ Absolute maximum ratings (Ta=25°C)**

Parameter	SR	LR	UR	UE	UY	UG	PG	BG	B	UB	UV	W	Unit
Forward Current I <sub>F</sub>	25	25	25	30	30	30	30	30	30	30	30	30	mA
Power Dissipation P <sub>d</sub>	60	60	60	65	65	75	110	110	120	120	120	120	mW
Reverse Voltage V <sub>R</sub>	5	5	5	5	5	5	5	5	5	5	5	5	V
Peak Forward Current I <sub>PF</sub> (Duty 1/10 @1KHZ)	150	150	150	150	150	150	150	100	100	100	100	100	mA
Operation Temperature T <sub>OPR</sub>	-40 to +80												°C
Storage Temperature T <sub>STG</sub>	-40 to +85												°C
Lead Soldering Temperature TSOL	Max.260±5°C for 3 sec Max. (1.6mm from the base of the epoxy bulb)												°C

## Bullet Type LED lamp

BL-L324

### ■ Package configuration & Internal circuit diagram

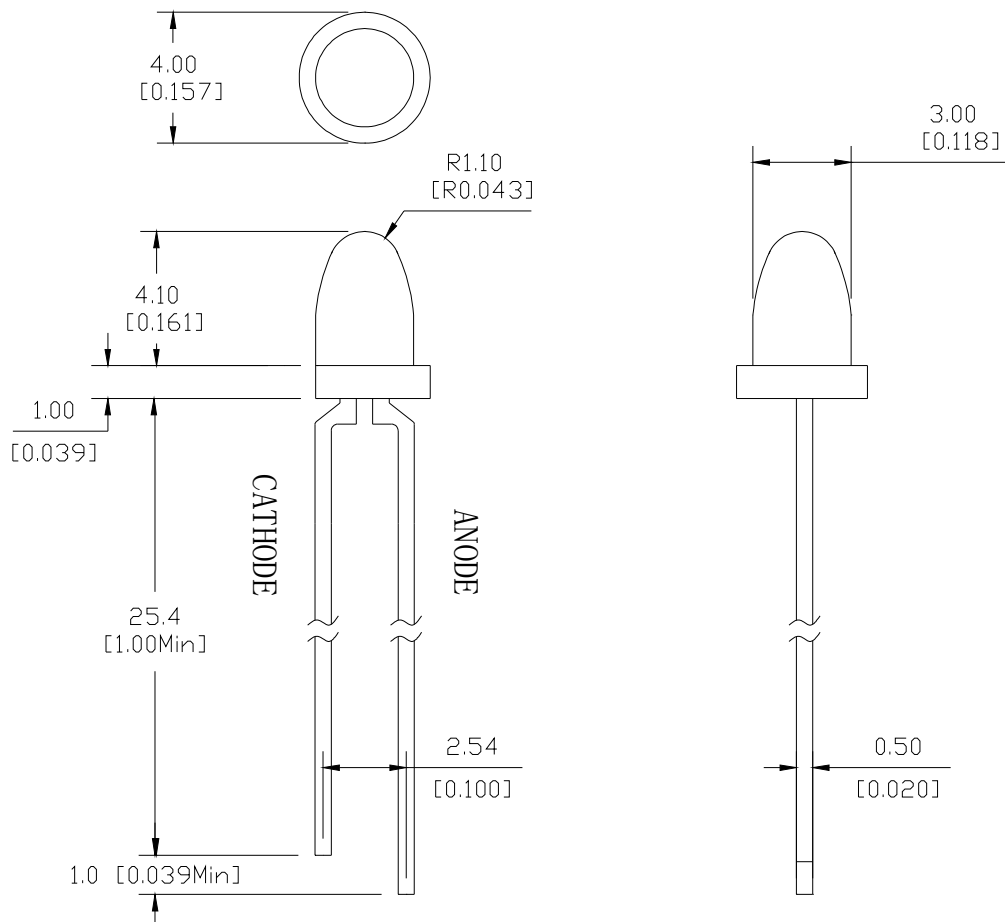

#### Notes:

1. All dimensions are in millimeters (inches)
2. Tolerance is  $\pm 0.25(0.01)$  unless otherwise noted.
3. Specifications are subject to change without notice.

## Bullet Type LED lamp

BL-L324

### Typical electrical-optical characteristics curves:

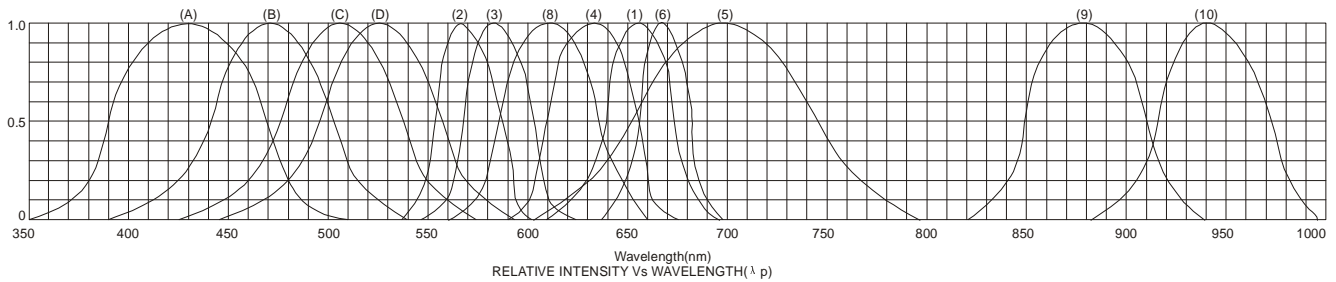

- |   |                                      |
|---|--------------------------------------|
| (1) - GaAsP/GaAs 655nm/Red                | (9) - GaAlAs 880nm                   |
| (2) - GaP 570nm/Yellow Green              | (10) - GaAs/GaAs & GaAlAs/GaAs 940nm |
| (3) - GaAsP/GaP 585nm/Yellow              | (A) - GaN/SiC 430nm/Blue             |
| (4) - GaAsP/GaP 635nm/Orange & Hi-Eff Red | (B) - InGaN/SiC 470nm/Blue           |
| (5) - GaP 700nm/Bright Red                | (C) - InGaN/SiC 505nm/Ultra Green    |
| (6) - GaAlAs/GaAs 660nm/Super Red         | (D) - InGaN/SiC 525nm/Ultra Green    |
| (8) - GaAsP/GaP 610nm/Super Red           |                                      |

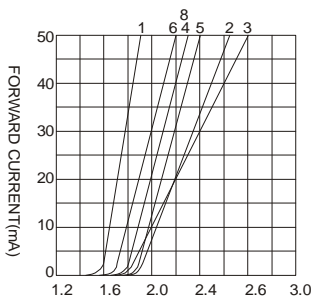

FORWARD VOLTAGE (Vf)  
FORWARD CURRENT VS.  
FORWARD VOLTAGE

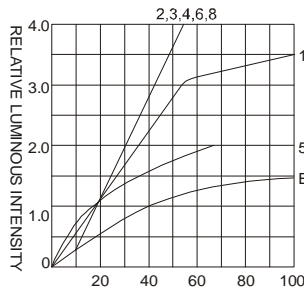

FORWARD CURRENT (mA)  
RELATIVE LUMINOUS  
INTENSITY VS. FORWARD  
CURRENT

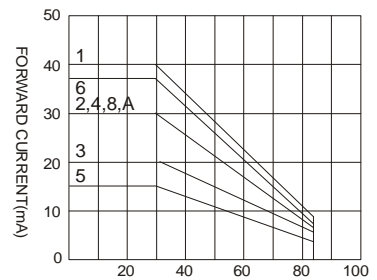

AMBIENT TEMPERATURE Ta(°C)  
FORWARD CURRENT VS. AMBIENT  
TEMPERATURE

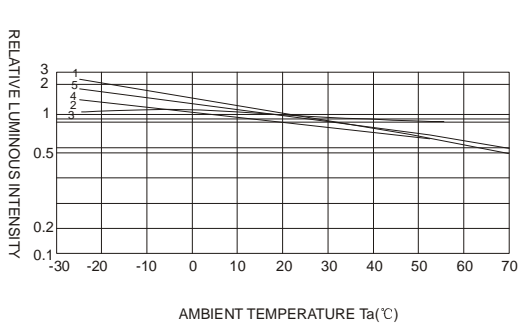

AMBIENT TEMPERATURE Ta(°C)

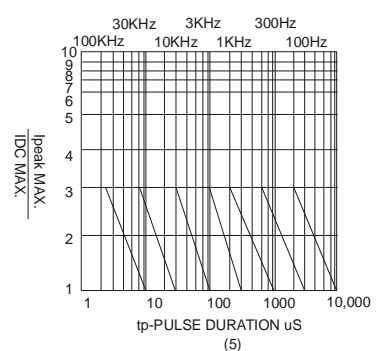
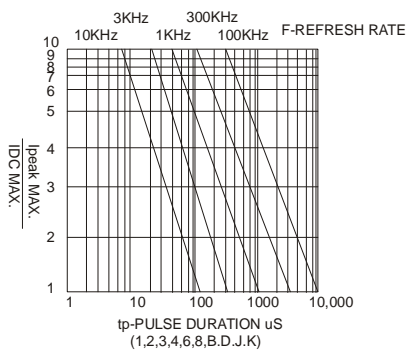

NOTE:25°C free air temperature unless otherwise specified