

# AP15P03Q

## P-Channel Power MOSFET

### ● General Description

The AP15P03Q combines advanced trench MOSFET technology with a low resistance package to provide extremely low  $R_{DS(ON)}$ . This device is ideal for load switch and battery protection applications.

### ● Features

- Advance high cell density Trench technology
- Low  $R_{DS(ON)}$  to minimize conductive loss
- Low Gate Charge for fast switching
- Low Thermal resistance

### ● Application

- MB/VGA Vcore
- SMPS 2<sup>nd</sup> Synchronous Rectifier
- POL application
- BLDC Motor driver

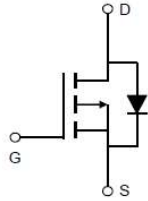
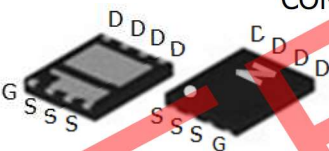
	<p><math>V_{DS} = -30V</math></p> <p><math>R_{DS(ON)} = 15m\Omega</math></p> <p><math>I_D = -30A</math></p>
 <p style="text-align: right;">■ RoHS COMPLIANT</p> <p style="text-align: center;">DFN3 x 3</p>	

### ● Ordering Information:

Marking	15P03
Packing	REEL TAPE
Basic ordering unit (pcs)	5000
Normal Package Material Ordering Code	AP15P03Q-TAP
Halogen Free Ordering Code	AP15P03Q-TAP-HF

### ● Absolute Maximum Ratings ( $T_c = 25^\circ C$ )

Parameter	Symbol	Rating	Unit
Drain-Source Voltage	$V_{DS}$	-30	V
Gate-Source Voltage	$V_{GS}$	$\pm 20$	V
Continuous Drain Current( $T_C=25^\circ C$ )	$I_D$	-30	A
Pulsed Drain Current <sup>①</sup>	$I_{DM}$	-60	A
Total Power Dissipation <sup>②</sup>	$P_D@T_C=25^\circ C$	17	W
Total Power Dissipation	$P_D@T_A=25^\circ C$	0.9	W
Operating Junction Temperature	$T_J$	-55 to 150	$^\circ C$
Storage Temperature	$T_{STG}$	-55 to 150	$^\circ C$
Single Pulse Avalanche Energy	$E_{AS}$	100	mJ

# AP15P03Q

## P-Channel Power MOSFET

### •Thermal resistance

Parameter	Symbol	Min.	Typ.	Max.	Unit
Thermal resistance, junction - case <sup>②</sup>	R <sub>thJC</sub>	-	-	34	° C/W
Thermal resistance, junction - ambient	R <sub>thJA</sub>	-	-	180	° C/W
Soldering temperature, wavesoldering for 10s	T <sub>sold</sub>	-	-	265	° C

### •Electronic Characteristics

Parameter	Symbol	Condition	Min.	Typ	Max.	Unit
Drain-Source Breakdown Voltage	BV <sub>DSS</sub>	V <sub>GS</sub> = 0V, I <sub>D</sub> = -250uA	-30			V
Gate Threshold Voltage	V <sub>GS(TH)</sub>	V <sub>GS</sub> = V <sub>DS</sub> , I <sub>D</sub> = -250uA	-1.2		-2.5	V
Drain-Source Leakage Current	I <sub>DSS</sub>	V <sub>DS</sub> = -30V, V <sub>GS</sub> = 0V			-1.0	uA
Gate- Source Leakage Current	I <sub>GSS</sub>	V <sub>GS</sub> = ±12V, V <sub>DS</sub> = 0V			±100	nA
Static Drain-source On Resistance	R <sub>DS(ON)</sub>	V <sub>GS</sub> = -10V, I <sub>D</sub> = -9A		15	20	mΩ
		V <sub>GS</sub> = -4.5V, I <sub>D</sub> = -8A		25	32	mΩ
Forward Transconductance	g <sub>FS</sub>	V <sub>DS</sub> = -10V, I <sub>D</sub> = -5A		9		s

### •Electronic Characteristics

Parameter	Symbol	Condition	Min.	Typ	Max.	Unit
Input capacitance	C <sub>iss</sub>	f = 1MHz	-	1650	-	pF
Output capacitance	C <sub>oss</sub>		-	330	-	
Reverse transfer capacitance	C <sub>rss</sub>		-	220	-	

### •Gate Charge characteristics(T<sub>a</sub> = 25°C)

Parameter	Symbol	Condition	Min.	Typ	Max.	Unit
Total gate charge	Q <sub>g</sub>	V <sub>DD</sub> = 25V I <sub>D</sub> = 8A V <sub>GS</sub> = 10V	-	15	-	nC
Gate - Source charge	Q <sub>gs</sub>		-	4	-	
Gate - Drain charge	Q <sub>gd</sub>		-	6	-	

Note: ① Pulse Test : Pulse width ≤ 300μs, Duty cycle ≤ 2% ;

② Device mounted on FR-4 substrate PC board, 2oz copper, with thermal bias to bottom layer 1inch square copper plate;

**AP15P03Q**

**P-Channel Power MOSFET**

Fig.1 Power Dissipation Derating Curve

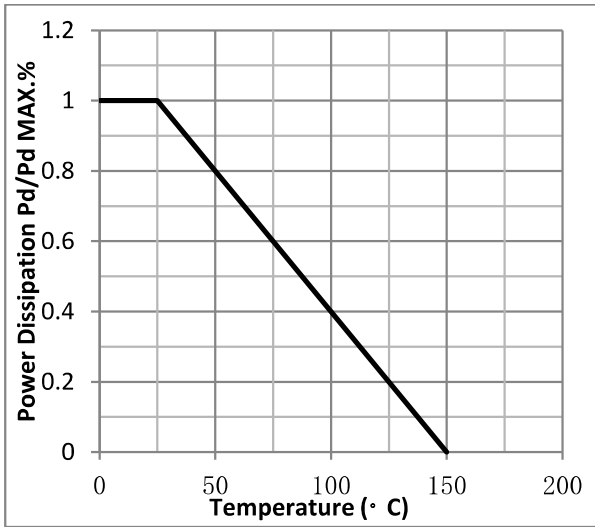

Fig.2 Typical output Characteristics

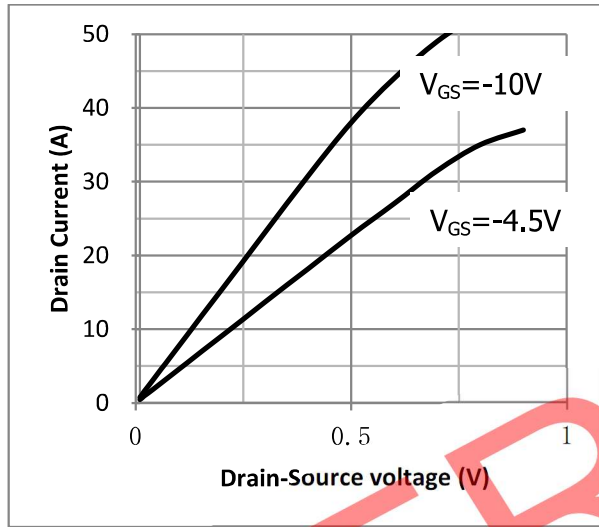

Fig.3 Threshold Voltage V.S Junction Temperature

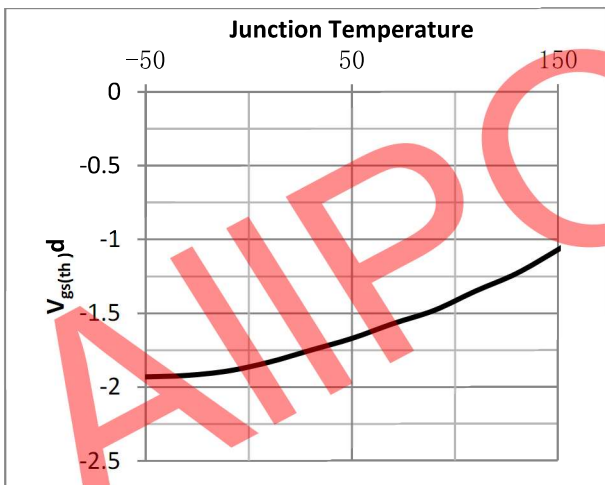

Fig.4 Resistance V.S Drain Current

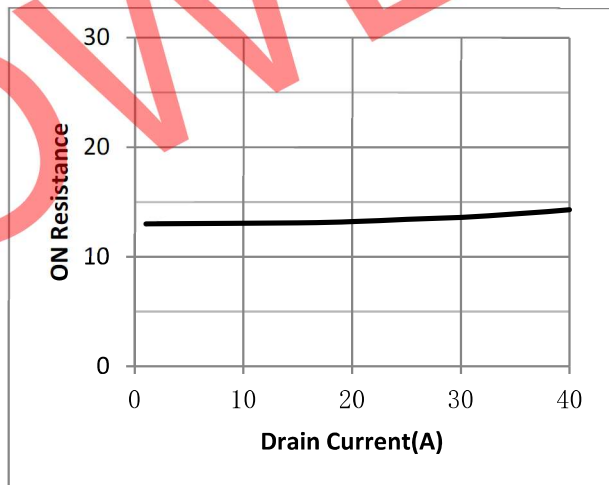

Fig.5 On-Resistance VS Gate Source Voltage

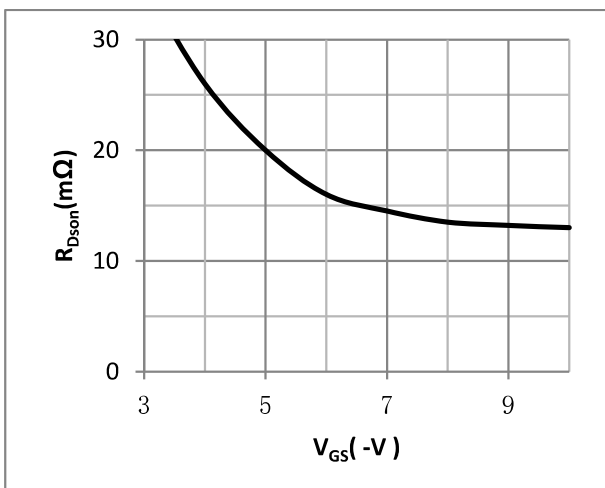
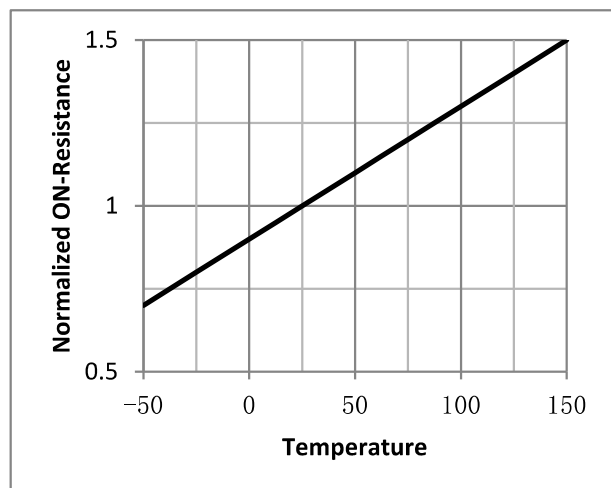

Fig.6 On-Resistance V.S Junction Temperature



**AP15P03Q**

**P-Channel Power MOSFET**

Fig.7 Switching Time Measurement Circuit

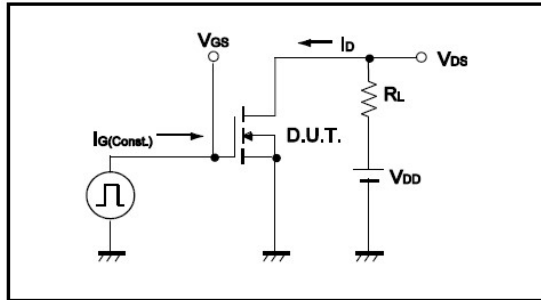

Fig.8 Gate Charge Waveform

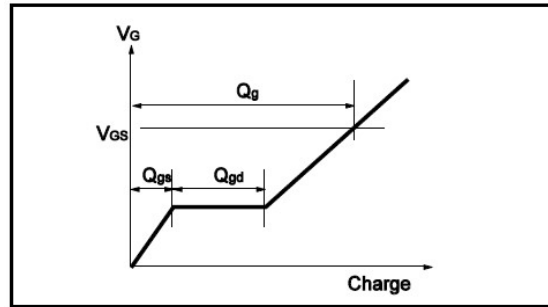

Fig.9 Switching Time Measurement Circuit

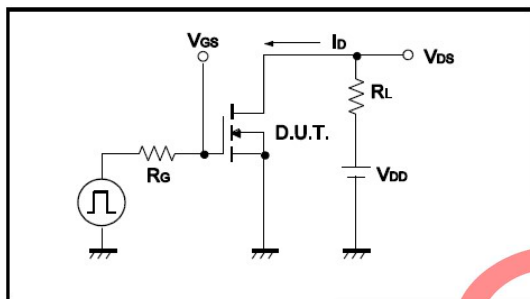

Fig.10 Gate Charge Waveform

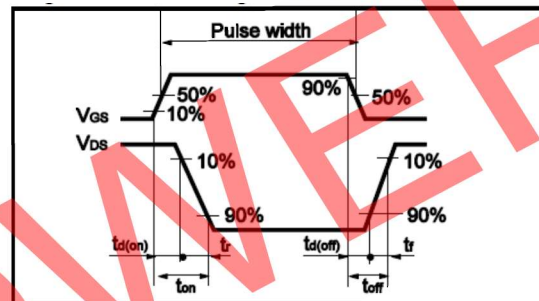

Fig.11 Avalanche Measurement Circuit

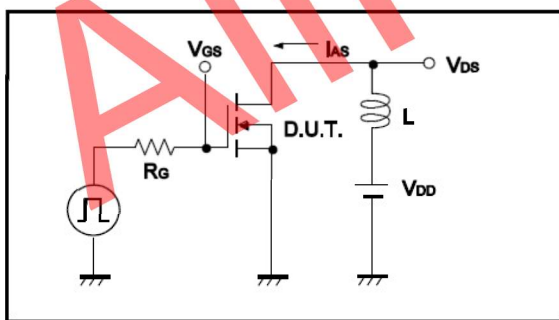
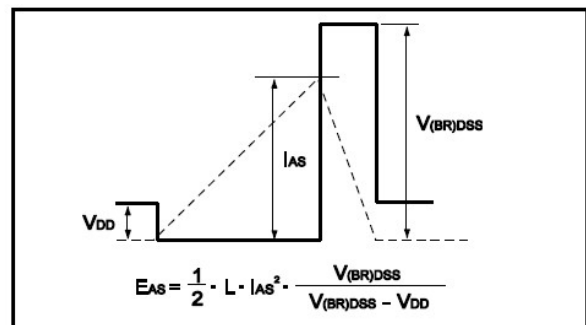

Fig.12 Avalanche Waveform



**AP15P03Q**

**P-Channel Power MOSFET**

•Dimensions(DFN3×3)

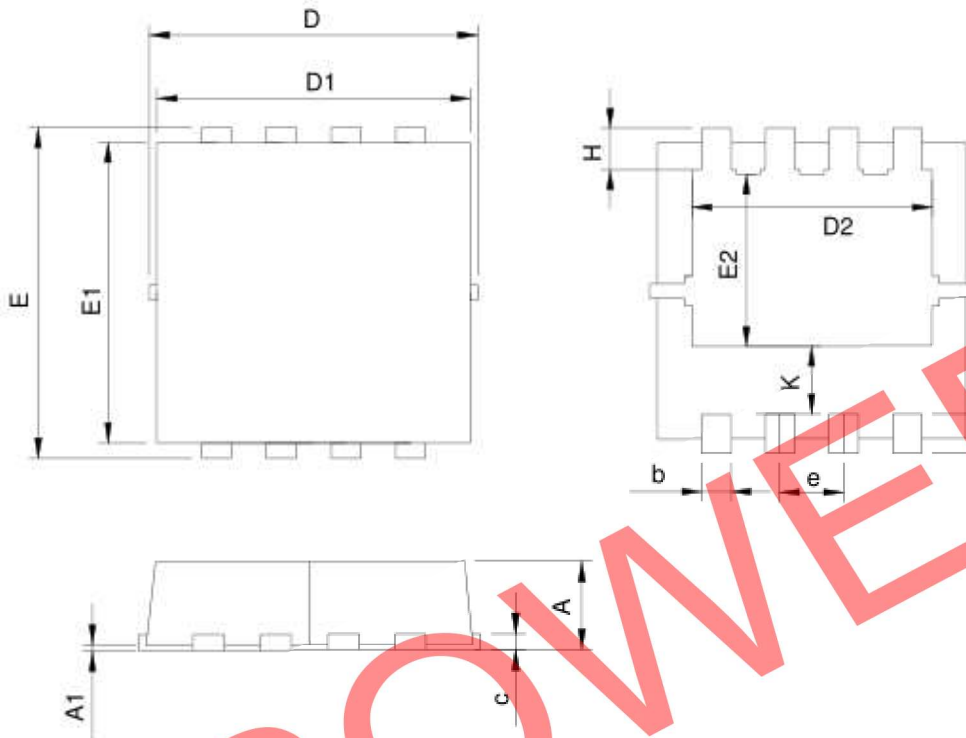

Symbol	DFN3.3x3.3-8			
	MILLIMETERS		INCHES	
	MIN.	MAX.	MIN.	MAX.
A	0.70	1.00	0.028	0.039
A1	0.00	0.05	0.000	0.002
b	0.25	0.35	0.010	0.014
c	0.14	0.20	0.006	0.008
D	3.10	3.50	0.122	0.138
D1	3.05	3.25	0.120	0.128
D2	2.35	2.55	0.093	0.100
E	3.10	3.50	0.122	0.138
E1	2.90	3.10	0.114	0.122
E2	1.64	1.84	0.065	0.072
e	0.65 BSC		0.026 BSC	
H	0.32	0.52	0.013	0.020
K	0.59	0.79	0.023	0.031
L	0.25	0.55	0.010	0.022

**RECOMMENDED LAND PATTERN**

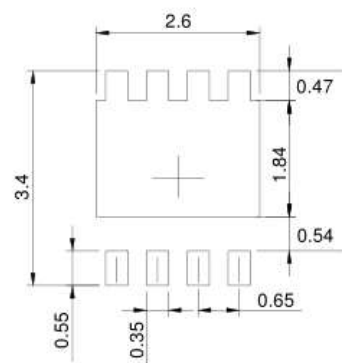

UNIT: mm