

LM285, LM385B

Micropower Voltage Reference Diodes

The LM285/LM385 series are micropower two-terminal bandgap voltage regulator diodes. Designed to operate over a wide current range of 10 μ A to 20 mA, these devices feature exceptionally low dynamic impedance, low noise and stable operation over time and temperature. Tight voltage tolerances are achieved by on-chip trimming. The large dynamic operating range enables these devices to be used in applications with widely varying supplies with excellent regulation. Extremely low operating current make these devices ideal for micropower circuitry like portable instrumentation, regulators and other analog circuitry where extended battery life is required.

The LM285/LM385 series are packaged in a low cost TO-226 plastic case and are available in two voltage versions of 1.235 V and 2.500 V as denoted by the device suffix (see Ordering Information table). The LM285 is specified over a -40°C to $+85^{\circ}\text{C}$ temperature range while the LM385 is rated from 0°C to $+70^{\circ}\text{C}$.

The LM385 is also available in a surface mount plastic package in voltages of 1.235 V and 2.500 V.

Features

- Operating Current from 10 μ A to 20 mA
- 1.0%, 1.5%, 2.0% and 3.0% Initial Tolerance Grades
- Low Temperature Coefficient
- 1.0 Ω Dynamic Impedance
- Surface Mount Package Available
- These Devices are Pb-Free and are RoHS Compliant

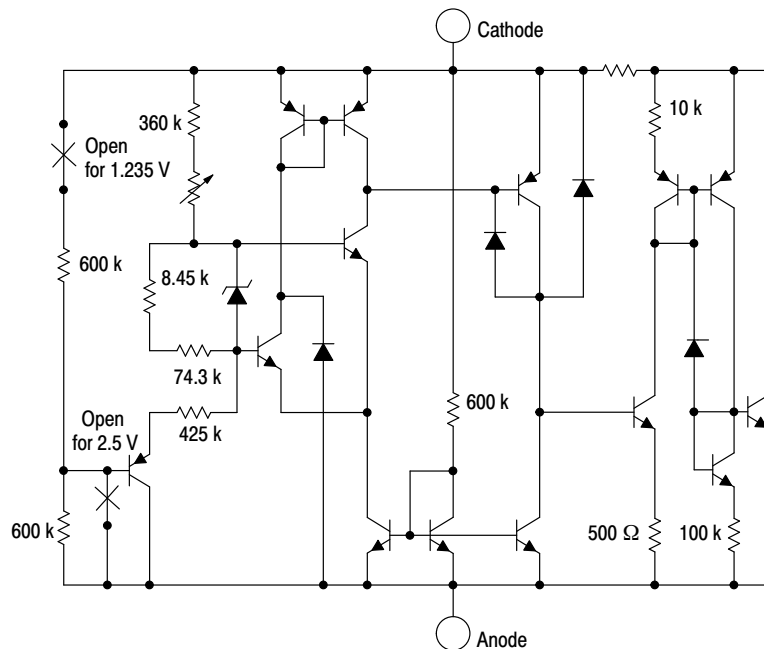

Figure 1. Representative Schematic Diagram



ON Semiconductor®

www.onsemi.com

MARKING DIAGRAMS



SOIC-8
D SUFFIX
CASE 751

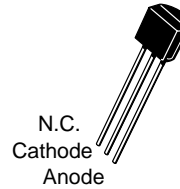
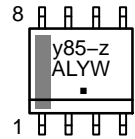

TO-92
(TO-226)
Z SUFFIX
CASE 29

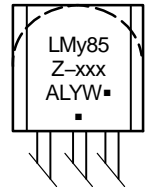

- xxx = 1.2 or 2.5
- y = 2 or 3
- z = 1 or 2
- A = Assembly Location
- L = Wafer Lot
- Y = Year
- W = Work Week
- = Pb-Free Package

(Note: Microdot may be in either location)

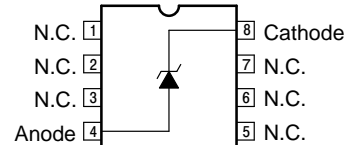
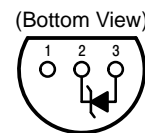

Standard Application

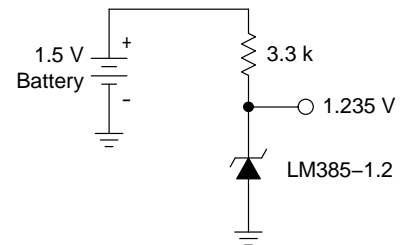

ORDERING INFORMATION

See detailed ordering and shipping information in the package dimensions section on page 6 of this data sheet.

LM285, LM385B

MAXIMUM RATINGS (T_A = 25°C, unless otherwise noted)

Rating	Symbol	Value	Unit
Reverse Current	I _R	30	mA
Forward Current	I _F	10	mA
Operating Ambient Temperature Range	T _A	-40 to +85 0 to +70	°C
Operating Junction Temperature	T _J	+150	°C
Storage Temperature Range	T _{stg}	-65 to +150	°C
Electrostatic Discharge Sensitivity (ESD) Human Body Model (HBM) Machine Model (MM) Charged Device Model (CDM)	ESD	4000 400 2000	V

Stresses exceeding those listed in the Maximum Ratings table may damage the device. If any of these limits are exceeded, device functionality should not be assumed, damage may occur and reliability may be affected.

ELECTRICAL CHARACTERISTICS (T_A = 25°C, unless otherwise noted)

Characteristic	Symbol	LM285-1.2			LM385-1.2/LM385B-1.2			Unit
		Min	Typ	Max	Min	Typ	Max	
Reverse Breakdown Voltage (I _{Rmin} ≤ I _R ≤ 20 mA) LM285-1.2/LM385B-1.2 T _A = T _{low} to T _{high} (Note 1) LM385-1.2 T _A = T _{low} to T _{high} (Note 1)	V _{(BR)R}	1.223 1.200	1.235 –	1.247 1.270	1.223 1.210	1.235 –	1.247 1.260	V
Minimum Operating Current T _A = 25°C T _A = T _{low} to T _{high} (Note 1)	I _{Rmin}	– –	8.0 –	10 20	– –	8.0 –	15 20	μA
Reverse Breakdown Voltage Change with Current I _{Rmin} ≤ I _R ≤ 1.0 mA, T _A = +25°C T _A = T _{low} to T _{high} (Note 1) 1.0 mA ≤ I _R ≤ 20 mA, T _A = +25°C T _A = T _{low} to T _{high} (Note 1)	ΔV _{(BR)R}	– – – –	– – – –	1.0 1.5 10 20	– – – –	– – – –	1.0 1.5 20 25	mV
Reverse Dynamic Impedance I _R = 100 μA, T _A = +25°C	Z	–	0.6	–	–	0.6	–	Ω
Average Temperature Coefficient 10 μA ≤ I _R ≤ 20 mA, T _A = T _{low} to T _{high} (Note 1)	ΔV _{(BR)R} /ΔT	–	80	–	–	80	–	ppm/°C
Wideband Noise (RMS) I _R = 100 μA, 10 Hz ≤ f ≤ 10 kHz	n	–	60	–	–	60	–	μV
Long Term Stability I _R = 100 μA, T _A = +25°C ± 0.1°C	S	–	20	–	–	20	–	ppm/kHR
Reverse Breakdown Voltage (I _{Rmin} ≤ I _R ≤ 20 mA) LM285-2.5/LM385B-2.5 T _A = T _{low} to T _{high} (Note 1) LM385-2.5 T _A = T _{low} to T _{high} (Note 1)	V _{(BR)R}	2.462 2.415	2.5 –	2.538 2.585	2.462 2.436	2.5 –	2.538 2.564	V
Minimum Operating Current T _A = 25°C T _A = T _{low} to T _{high} (Note 1)	I _{Rmin}	– –	13 –	20 30	– –	13 –	20 30	μA

- T_{low} = -40°C for LM285-1.2, LM285-2.5
 T_{high} = +85°C for LM285-1.2, LM285-2.5
 T_{low} = 0°C for LM385-1.2, LM385B-1.2, LM385-2.5, LM385B-2.5
 T_{high} = +70°C for LM385-1.2, LM385B-1.2, LM385-2.5, LM385B-2.5

LM285, LM385B

ELECTRICAL CHARACTERISTICS (T_A = 25°C, unless otherwise noted)

Characteristic	Symbol	LM285-1.2			LM385-1.2/LM385B-1.2			Unit
		Min	Typ	Max	Min	Typ	Max	
Reverse Breakdown Voltage Change with Current I _{Rmin} ≤ I _R ≤ 1.0 mA, T _A = +25°C T _A = T _{low} to T _{high} (Note 2) 1.0 mA ≤ I _R ≤ 20 mA, T _A = +25°C T _A = T _{low} to T _{high} (Note 2)	ΔV _{(BR)R}	-	-	1.0	-	-	2.0	mV
		-	-	1.5	-	-	2.5	
		-	-	10	-	-	20	
		-	-	20	-	-	25	
Reverse Dynamic Impedance I _R = 100 μA, T _A = +25°C	Z	-	0.6	-	-	0.6	-	Ω
Average Temperature Coefficient 20 μA ≤ I _R ≤ 20 mA, T _A = T _{low} to T _{high} (Note 2)	ΔV _{(BR)R} /ΔT	-	80	-	-	80	-	ppm/°C
Wideband Noise (RMS) I _R = 100 μA, 10 Hz ≤ f ≤ 10 kHz	n	-	120	-	-	120	-	μV
Long Term Stability I _R = 100 μA, T _A = +25°C ± 0.1°C	S	-	20	-	-	20	-	ppm/kHR

2. T_{low} = -40°C for LM285-1.2, LM285-2.5
 T_{high} = +85°C for LM285-1.2, LM285-2.5
 T_{low} = 0°C for LM385-1.2, LM385B-1.2, LM385-2.5, LM385B-2.5
 T_{high} = +70°C for LM385-1.2, LM385B-1.2, LM385-2.5, LM385B-2.5

LM285, LM385B

TYPICAL PERFORMANCE CURVES FOR LM285-1.2/385-1.2/385B-1.2

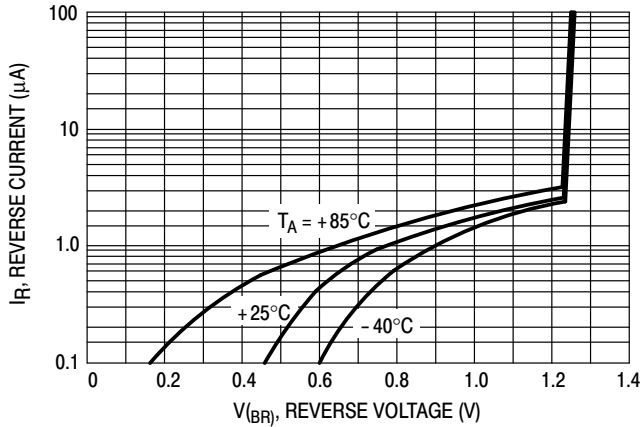

Figure 2. Reverse Characteristics

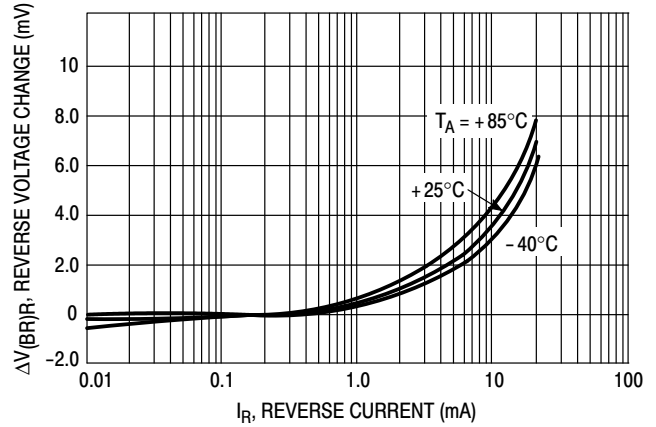

Figure 3. Reverse Characteristics

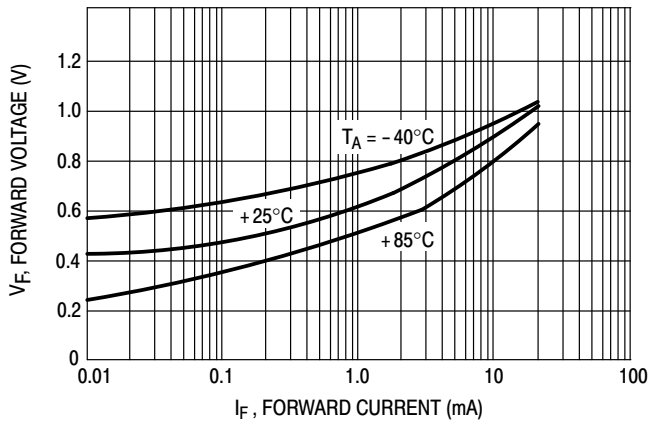

Figure 4. Forward Characteristics

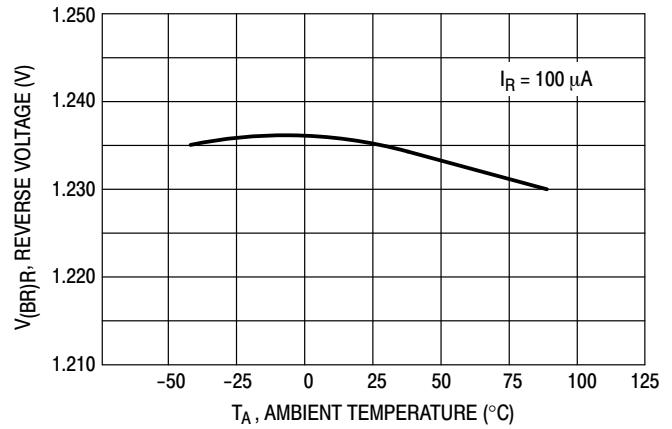

Figure 5. Temperature Drift

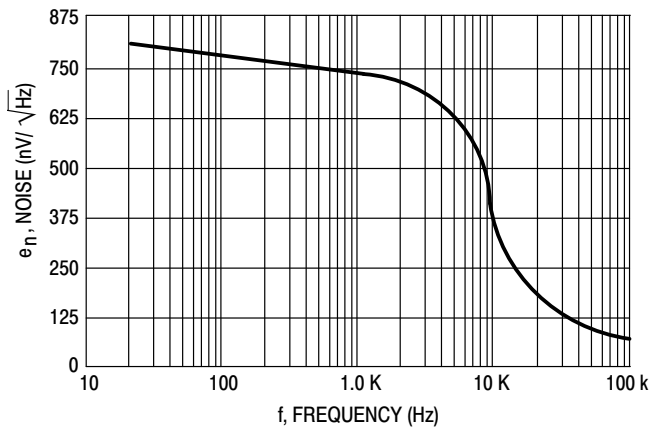

Figure 6. Noise Voltage

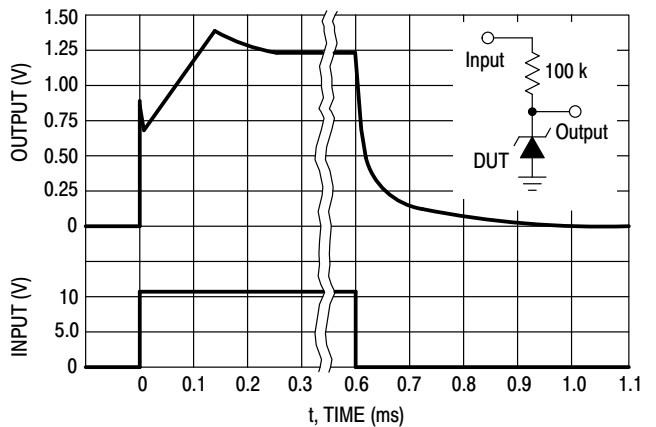

Figure 7. Response Time

LM285, LM385B

TYPICAL PERFORMANCE CURVES FOR LM285-2.5/385-2.5/385B-2.5

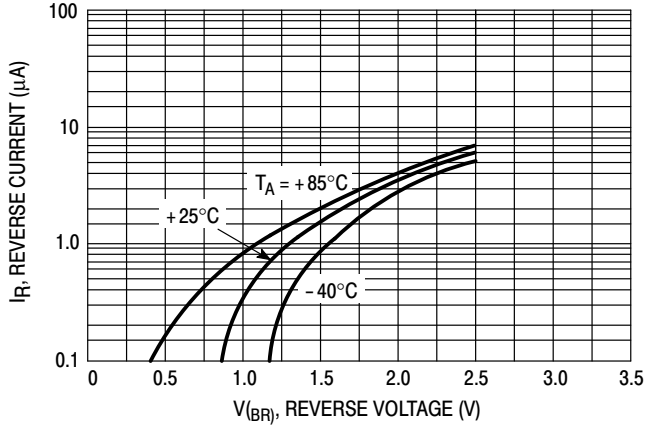

Figure 8. Reverse Characteristics

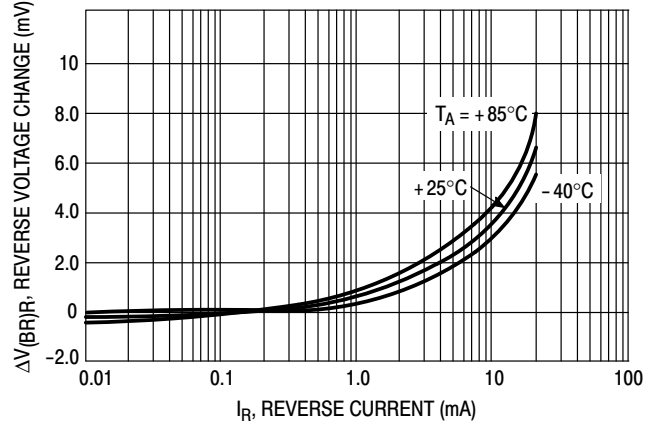

Figure 9. Reverse Characteristics

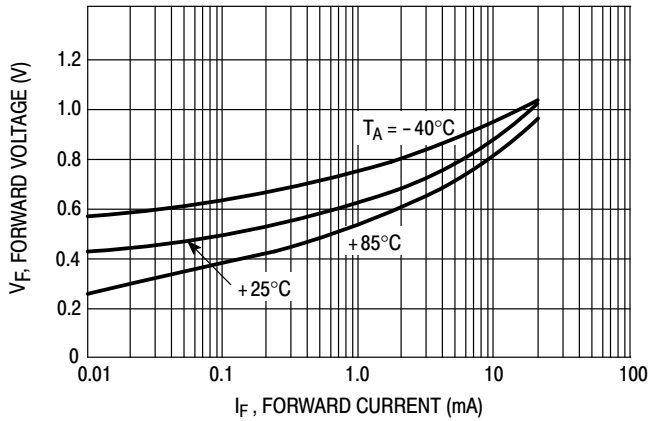

Figure 10. Forward Characteristics

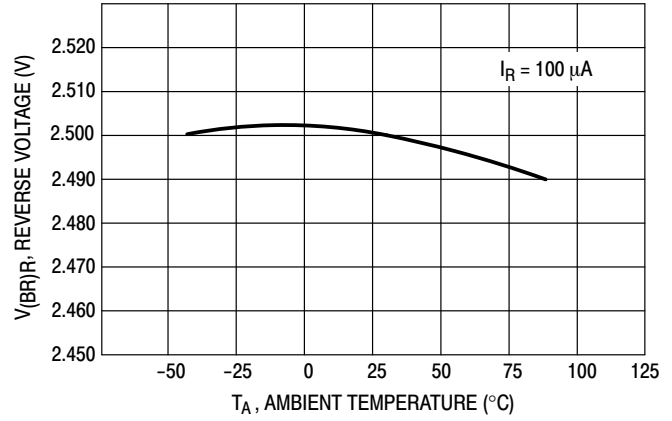

Figure 11. Temperature Drift

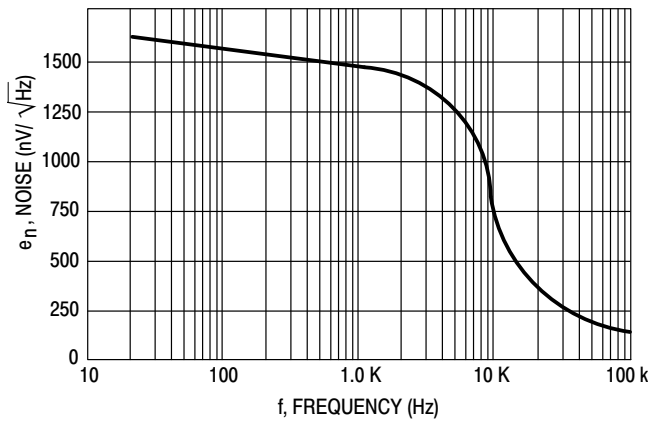

Figure 12. Noise Voltage

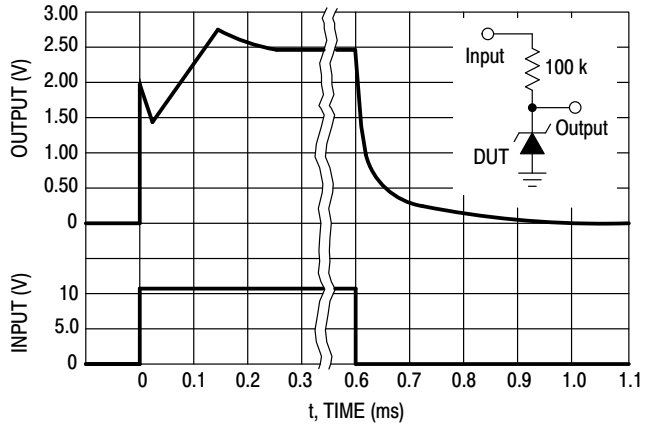

Figure 13. Response Time

LM285, LM385B

ORDERING INFORMATION

Device	Operating Temperature Range	Reverse Break-Down Voltage	Package	Shipping†	
LM285D-1.2	T _A = -40°C to +85°C	1.235 V	SOIC-8	98 Units / Rail	
LM285D-1.2G			SOIC-8 (Pb-Free)	98 Units / Rail	
LM285D-1.2R2			SOIC-8	2500 / Tape & Reel	
LM285D-1.2R2G			SOIC-8 (Pb-Free)	2500 / Tape & Reel	
LM285D-2.5		2.500 V	SOIC-8	98 Units / Rail	
LM285D-2.5G			SOIC-8 (Pb-Free)	98 Units / Rail	
LM285D-2.5R2			SOIC-8	2500 / Tape & Reel	
LM285D-2.5R2G			SOIC-8 (Pb-Free)	2500 / Tape & Reel	
LM285Z-1.2		T _A = -40°C to +85°C	1.235 V	TO-92	2000 Units / Bag
LM285Z-1.2G				TO-92 (Pb-Free)	2000 Units / Bag
LM285Z-2.5			2.500 V	TO-92	2000 Units / Bag
LM285Z-2.5G				TO-92 (Pb-Free)	2000 Units / Bag
LM285Z-1.2RA			1.235 V	TO-92	2000 / Tape & Reel
LM285Z-1.2RAG				TO-92 (Pb-Free)	2000 / Tape & Reel
LM285Z-2.5RA			2.500 V	TO-92	2000 / Tape & Reel
LM285Z-2.5RAG				TO-92 (Pb-Free)	2000 / Tape & Reel
LM285Z-2.5RP	TO-92	2000 Units / Fan-Fold			
LM285Z-2.5RPG	TO-92 (Pb-Free)	2000 Units / Fan-Fold			
LM385BD-1.2	T _A = 0°C to +70°C	1.235 V	SOIC-8	98 Units / Rail	
LM385BD-1.2G			SOIC-8 (Pb-Free)	98 Units / Rail	
LM385BD-1.2R2			SOIC-8	2500 / Tape & Reel	
LM385BD-1.2R2G			SOIC-8 (Pb-Free)	2500 / Tape & Reel	
LM385BD-2.5		2.500 V	SOIC-8	98 Units / Rail	
LM385BD-2.5G			SOIC-8 (Pb-Free)	98 Units / Rail	
LM385BD-2.5R2			SOIC-8	2500 / Tape & Reel	
LM385BD-2.5R2G			SOIC-8 (Pb-Free)	2500 / Tape & Reel	
LM385BZ-1.2		T _A = 0°C to +70°C	1.235 V	TO-92	2000 Units / Bag
LM385BZ-1.2G				TO-92 (Pb-Free)	2000 Units / Bag
LM385BZ-1.2RA				TO-92	2000 / Tape & Reel
LM385BZ-1.2RAG				TO-92 (Pb-Free)	2000 / Tape & Reel

†For information on tape and reel specifications, including part orientation and tape sizes, please refer to our Tape and Reel Packaging Specifications Brochure, BRD8011/D.

LM285, LM385B

ORDERING INFORMATION

Device	Operating Temperature Range	Reverse Break-Down Voltage	Package	Shipping†			
LM385BZ-2.5	$T_A = 0^{\circ}\text{C to } +70^{\circ}\text{C}$	2.500 V	TO-92	2000 Units / Bag			
LM385BZ-2.5G			TO-92 (Pb-Free)	2000 Units / Bag			
LM385BZ-2.5RA			TO-92	2000 / Tape & Reel			
LM385BZ-2.5RAG			TO-92 (Pb-Free)	2000 / Tape & Reel			
LM385D-1.2		1.235 V	1.235 V	SOIC-8	98 Units / Rail		
LM385D-1.2G				SOIC-8 (Pb-Free)	98 Units / Rail		
LM385D-1.2R2				SOIC-8	2500 / Tape & Reel		
LM385D-1.2R2G				SOIC-8 (Pb-Free)	2500 / Tape & Reel		
LM385D-2.5		2.500 V	2.500 V	SOIC-8	98 Units / Rail		
LM385D-2.5G				SOIC-8 (Pb-Free)	98 Units / Rail		
LM385D-2.5R2				SOIC-8	2500 / Tape & Reel		
LM385D-2.5R2G				SOIC-8 (Pb-Free)	2500 / Tape & Reel		
LM385Z-1.2		1.235 V	1.235 V	TO-92	2000 Units / Bag		
LM385Z-1.2G				TO-92 (Pb-Free)	2000 Units / Bag		
LM385Z-1.2RA				TO-92	2000 / Tape & Reel		
LM385Z-1.2RAG				TO-92 (Pb-Free)	2000 / Tape & Reel		
LM385Z-1.2RP				TO-92	2000 / Ammo Box		
LM385Z-1.2RPG				TO-92 (Pb-Free)	2000 / Ammo Box		
LM385Z-2.5				2.500 V	2.500 V	TO-92	2000 Units / Bag
LM385Z-2.5G						TO-92 (Pb-Free)	2000 Units / Bag
LM385Z-2.5RP	TO-92	2000 / Ammo Box					
LM385Z-2.5RPG	TO-92 (Pb-Free)	2000 / Ammo Box					

†For information on tape and reel specifications, including part orientation and tape sizes, please refer to our Tape and Reel Packaging Specifications Brochure, BRD8011/D.

MECHANICAL CASE OUTLINE PACKAGE DIMENSIONS

ON Semiconductor®



SCALE 1:1

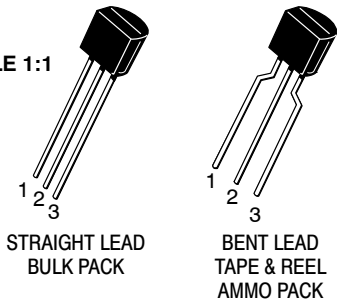

TO-92 (TO-226)
CASE 29-11
ISSUE AM

DATE 09 MAR 2007

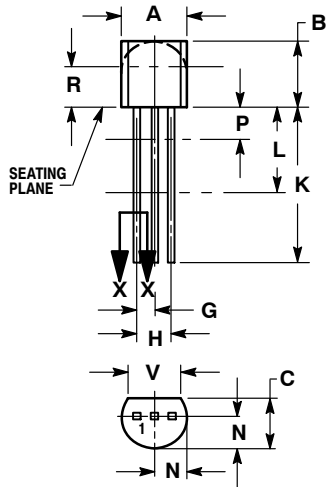

STRAIGHT LEAD
BULK PACK

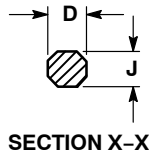

NOTES:

1. DIMENSIONING AND TOLERANCING PER ANSI Y14.5M, 1982.
2. CONTROLLING DIMENSION: INCH.
3. CONTOUR OF PACKAGE BEYOND DIMENSION R IS UNCONTROLLED.
4. LEAD DIMENSION IS UNCONTROLLED IN P AND BEYOND DIMENSION K MINIMUM.

DIM	INCHES		MILLIMETERS	
	MIN	MAX	MIN	MAX
A	0.175	0.205	4.45	5.20
B	0.170	0.210	4.32	5.33
C	0.125	0.165	3.18	4.19
D	0.016	0.021	0.407	0.533
G	0.045	0.055	1.15	1.39
H	0.095	0.105	2.42	2.66
J	0.015	0.020	0.39	0.50
K	0.500	---	12.70	---
L	0.250	---	6.35	---
N	0.080	0.105	2.04	2.66
P	---	0.100	---	2.54
R	0.115	---	2.93	---
V	0.135	---	3.43	---

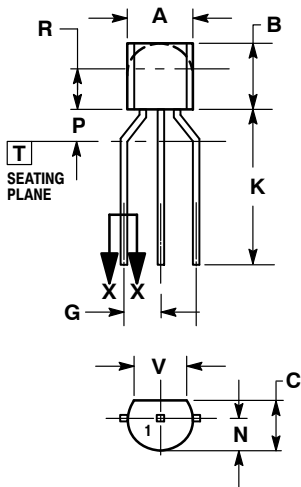

BENT LEAD
TAPE & REEL
AMMO PACK

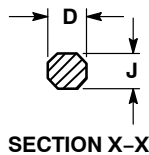

NOTES:

1. DIMENSIONING AND TOLERANCING PER ASME Y14.5M, 1994.
2. CONTROLLING DIMENSION: MILLIMETERS.
3. CONTOUR OF PACKAGE BEYOND DIMENSION R IS UNCONTROLLED.
4. LEAD DIMENSION IS UNCONTROLLED IN P AND BEYOND DIMENSION K MINIMUM.

DIM	MILLIMETERS	
	MIN	MAX
A	4.45	5.20
B	4.32	5.33
C	3.18	4.19
D	0.40	0.54
G	2.40	2.80
J	0.39	0.50
K	12.70	---
N	2.04	2.66
P	1.50	4.00
R	2.93	---
V	3.43	---

STYLES ON PAGE 2

DOCUMENT NUMBER:	98ASB42022B	Electronic versions are uncontrolled except when accessed directly from the Document Repository. Printed versions are uncontrolled except when stamped "CONTROLLED COPY" in red.
STATUS:	ON SEMICONDUCTOR STANDARD	
NEW STANDARD:		
DESCRIPTION:	TO-92 (TO-226)	PAGE 1 OF 3

TO-92 (TO-226)
CASE 29-11
ISSUE AM

DATE 09 MAR 2007

STYLE 1:
 PIN 1. EMITTER
 2. BASE
 3. COLLECTOR

STYLE 2:
 PIN 1. BASE
 2. EMITTER
 3. COLLECTOR

STYLE 3:
 PIN 1. ANODE
 2. ANODE
 3. CATHODE

STYLE 4:
 PIN 1. CATHODE
 2. CATHODE
 3. ANODE

STYLE 5:
 PIN 1. DRAIN
 2. SOURCE
 3. GATE

STYLE 6:
 PIN 1. GATE
 2. SOURCE & SUBSTRATE
 3. DRAIN

STYLE 7:
 PIN 1. SOURCE
 2. DRAIN
 3. GATE

STYLE 8:
 PIN 1. DRAIN
 2. GATE
 3. SOURCE & SUBSTRATE

STYLE 9:
 PIN 1. BASE 1
 2. EMITTER
 3. BASE 2

STYLE 10:
 PIN 1. CATHODE
 2. GATE
 3. ANODE

STYLE 11:
 PIN 1. ANODE
 2. CATHODE & ANODE
 3. CATHODE

STYLE 12:
 PIN 1. MAIN TERMINAL 1
 2. GATE
 3. MAIN TERMINAL 2

STYLE 13:
 PIN 1. ANODE 1
 2. GATE
 3. CATHODE 2

STYLE 14:
 PIN 1. EMITTER
 2. COLLECTOR
 3. BASE

STYLE 15:
 PIN 1. ANODE 1
 2. CATHODE
 3. ANODE 2

STYLE 16:
 PIN 1. ANODE
 2. GATE
 3. CATHODE

STYLE 17:
 PIN 1. COLLECTOR
 2. BASE
 3. EMITTER

STYLE 18:
 PIN 1. ANODE
 2. CATHODE
 3. NOT CONNECTED

STYLE 19:
 PIN 1. GATE
 2. ANODE
 3. CATHODE

STYLE 20:
 PIN 1. NOT CONNECTED
 2. CATHODE
 3. ANODE

STYLE 21:
 PIN 1. COLLECTOR
 2. EMITTER
 3. BASE

STYLE 22:
 PIN 1. SOURCE
 2. GATE
 3. DRAIN

STYLE 23:
 PIN 1. GATE
 2. SOURCE
 3. DRAIN

STYLE 24:
 PIN 1. EMITTER
 2. COLLECTOR/ANODE
 3. CATHODE

STYLE 25:
 PIN 1. MT 1
 2. GATE
 3. MT 2

STYLE 26:
 PIN 1. V_{CC}
 2. GROUND 2
 3. OUTPUT

STYLE 27:
 PIN 1. MT
 2. SUBSTRATE
 3. MT

STYLE 28:
 PIN 1. CATHODE
 2. ANODE
 3. GATE

STYLE 29:
 PIN 1. NOT CONNECTED
 2. ANODE
 3. CATHODE

STYLE 30:
 PIN 1. DRAIN
 2. GATE
 3. SOURCE

STYLE 31:
 PIN 1. GATE
 2. DRAIN
 3. SOURCE

STYLE 32:
 PIN 1. BASE
 2. COLLECTOR
 3. EMITTER

STYLE 33:
 PIN 1. RETURN
 2. INPUT
 3. OUTPUT

STYLE 34:
 PIN 1. INPUT
 2. GROUND
 3. LOGIC

STYLE 35:
 PIN 1. GATE
 2. COLLECTOR
 3. EMITTER

DOCUMENT NUMBER:	98ASB42022B	Electronic versions are uncontrolled except when accessed directly from the Document Repository. Printed versions are uncontrolled except when stamped "CONTROLLED COPY" in red.
STATUS:	ON SEMICONDUCTOR STANDARD	
NEW STANDARD:		
DESCRIPTION:	TO-92 (TO-226)	PAGE 2 OF 3

MECHANICAL CASE OUTLINE PACKAGE DIMENSIONS

ON Semiconductor®

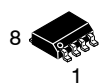

SCALE 1:1

SOIC-8 NB
CASE 751-07
ISSUE AK

DATE 16 FEB 2011

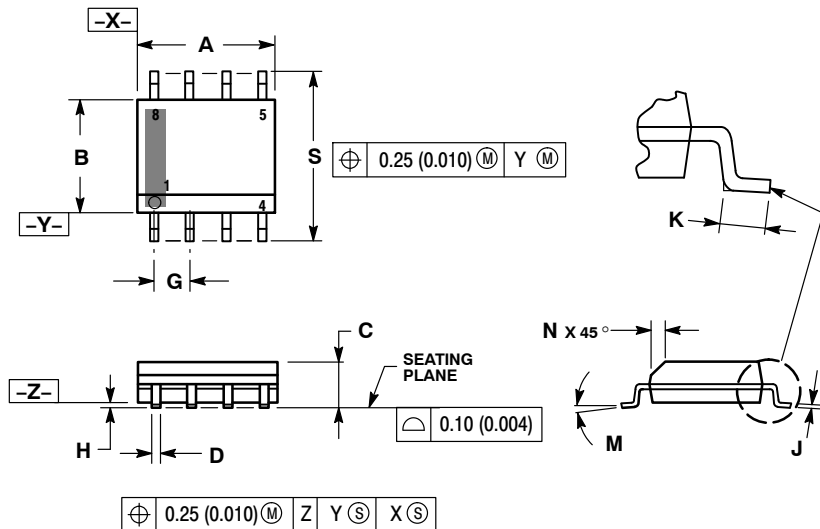

NOTES:

1. DIMENSIONING AND TOLERANCING PER ANSI Y14.5M, 1982.
2. CONTROLLING DIMENSION: MILLIMETER.
3. DIMENSION A AND B DO NOT INCLUDE MOLD PROTRUSION.
4. MAXIMUM MOLD PROTRUSION 0.15 (0.006) PER SIDE.
5. DIMENSION D DOES NOT INCLUDE DAMBAR PROTRUSION. ALLOWABLE DAMBAR PROTRUSION SHALL BE 0.127 (0.005) TOTAL IN EXCESS OF THE D DIMENSION AT MAXIMUM MATERIAL CONDITION.
6. 751-01 THRU 751-06 ARE OBSOLETE. NEW STANDARD IS 751-07.

DIM	MILLIMETERS		INCHES	
	MIN	MAX	MIN	MAX
A	4.80	5.00	0.189	0.197
B	3.80	4.00	0.150	0.157
C	1.35	1.75	0.053	0.069
D	0.33	0.51	0.013	0.020
G	1.27 BSC		0.050 BSC	
H	0.10	0.25	0.004	0.010
J	0.19	0.25	0.007	0.010
K	0.40	1.27	0.016	0.050
M	0°	8°	0°	8°
N	0.25	0.50	0.010	0.020
S	5.80	6.20	0.228	0.244

GENERIC MARKING DIAGRAM*

SOLDERING FOOTPRINT*

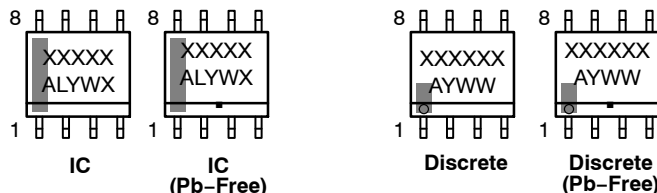
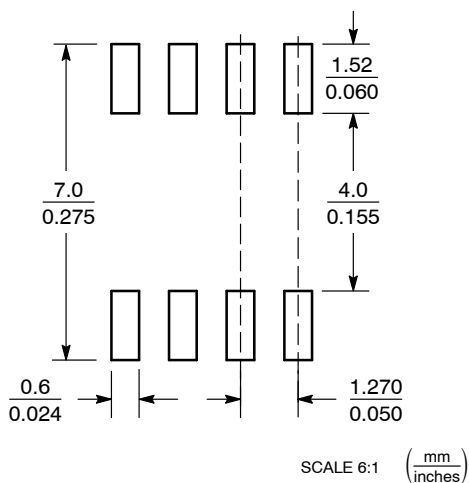

XXXXX = Specific Device Code
 A = Assembly Location
 L = Wafer Lot
 Y = Year
 W = Work Week
 ■ = Pb-Free Package

XXXXXX = Specific Device Code
 A = Assembly Location
 Y = Year
 WW = Work Week
 ■ = Pb-Free Package

*This information is generic. Please refer to device data sheet for actual part marking. Pb-Free indicator, "G" or microdot "•", may or may not be present. Some products may not follow the Generic Marking.

*For additional information on our Pb-Free strategy and soldering details, please download the ON Semiconductor Soldering and Mounting Techniques Reference Manual, SOLDERRM/D.

STYLES ON PAGE 2

DOCUMENT NUMBER:	98ASB42564B	Electronic versions are uncontrolled except when accessed directly from the Document Repository. Printed versions are uncontrolled except when stamped "CONTROLLED COPY" in red.
DESCRIPTION:	SOIC-8 NB	PAGE 1 OF 2

ON Semiconductor and ON are trademarks of Semiconductor Components Industries, LLC dba ON Semiconductor or its subsidiaries in the United States and/or other countries. ON Semiconductor reserves the right to make changes without further notice to any products herein. ON Semiconductor makes no warranty, representation or guarantee regarding the suitability of its products for any particular purpose, nor does ON Semiconductor assume any liability arising out of the application or use of any product or circuit, and specifically disclaims any and all liability, including without limitation special, consequential or incidental damages. ON Semiconductor does not convey any license under its patent rights nor the rights of others.

SOIC-8 NB
CASE 751-07
ISSUE AK

DATE 16 FEB 2011

- | | | | |
|--|---|---|---|
| <p>STYLE 1:
 PIN 1. EMITTER
 2. COLLECTOR
 3. COLLECTOR
 4. EMITTER
 5. EMITTER
 6. BASE
 7. BASE
 8. EMITTER</p> | <p>STYLE 2:
 PIN 1. COLLECTOR, DIE, #1
 2. COLLECTOR, #1
 3. COLLECTOR, #2
 4. COLLECTOR, #2
 5. BASE, #2
 6. EMITTER, #2
 7. BASE, #1
 8. EMITTER, #1</p> | <p>STYLE 3:
 PIN 1. DRAIN, DIE #1
 2. DRAIN, #1
 3. DRAIN, #2
 4. DRAIN, #2
 5. GATE, #2
 6. SOURCE, #2
 7. GATE, #1
 8. SOURCE, #1</p> | <p>STYLE 4:
 PIN 1. ANODE
 2. ANODE
 3. ANODE
 4. ANODE
 5. ANODE
 6. ANODE
 7. ANODE
 8. COMMON CATHODE</p> |
| <p>STYLE 5:
 PIN 1. DRAIN
 2. DRAIN
 3. DRAIN
 4. DRAIN
 5. GATE
 6. GATE
 7. SOURCE
 8. SOURCE</p> | <p>STYLE 6:
 PIN 1. SOURCE
 2. DRAIN
 3. DRAIN
 4. SOURCE
 5. SOURCE
 6. GATE
 7. GATE
 8. SOURCE</p> | <p>STYLE 7:
 PIN 1. INPUT
 2. EXTERNAL BYPASS
 3. THIRD STAGE SOURCE
 4. GROUND
 5. DRAIN
 6. GATE 3
 7. SECOND STAGE Vd
 8. FIRST STAGE Vd</p> | <p>STYLE 8:
 PIN 1. COLLECTOR, DIE #1
 2. BASE, #1
 3. BASE, #2
 4. COLLECTOR, #2
 5. COLLECTOR, #2
 6. EMITTER, #2
 7. EMITTER, #1
 8. COLLECTOR, #1</p> |
| <p>STYLE 9:
 PIN 1. EMITTER, COMMON
 2. COLLECTOR, DIE #1
 3. COLLECTOR, DIE #2
 4. EMITTER, COMMON
 5. EMITTER, COMMON
 6. BASE, DIE #2
 7. BASE, DIE #1
 8. EMITTER, COMMON</p> | <p>STYLE 10:
 PIN 1. GROUND
 2. BIAS 1
 3. OUTPUT
 4. GROUND
 5. GROUND
 6. BIAS 2
 7. INPUT
 8. GROUND</p> | <p>STYLE 11:
 PIN 1. SOURCE 1
 2. GATE 1
 3. SOURCE 2
 4. GATE 2
 5. DRAIN 2
 6. DRAIN 2
 7. DRAIN 1
 8. DRAIN 1</p> | <p>STYLE 12:
 PIN 1. SOURCE
 2. SOURCE
 3. SOURCE
 4. GATE
 5. DRAIN
 6. DRAIN
 7. DRAIN
 8. DRAIN</p> |
| <p>STYLE 13:
 PIN 1. N.C.
 2. SOURCE
 3. SOURCE
 4. GATE
 5. DRAIN
 6. DRAIN
 7. DRAIN
 8. DRAIN</p> | <p>STYLE 14:
 PIN 1. N-SOURCE
 2. N-GATE
 3. P-SOURCE
 4. P-GATE
 5. P-DRAIN
 6. P-DRAIN
 7. N-DRAIN
 8. N-DRAIN</p> | <p>STYLE 15:
 PIN 1. ANODE 1
 2. ANODE 1
 3. ANODE 1
 4. ANODE 1
 5. CATHODE, COMMON
 6. CATHODE, COMMON
 7. CATHODE, COMMON
 8. CATHODE, COMMON</p> | <p>STYLE 16:
 PIN 1. EMITTER, DIE #1
 2. BASE, DIE #1
 3. EMITTER, DIE #2
 4. BASE, DIE #2
 5. COLLECTOR, DIE #2
 6. COLLECTOR, DIE #2
 7. COLLECTOR, DIE #1
 8. COLLECTOR, DIE #1</p> |
| <p>STYLE 17:
 PIN 1. VCC
 2. V2OUT
 3. V1OUT
 4. TXE
 5. RXE
 6. VEE
 7. GND
 8. ACC</p> | <p>STYLE 18:
 PIN 1. ANODE
 2. ANODE
 3. SOURCE
 4. GATE
 5. DRAIN
 6. DRAIN
 7. CATHODE
 8. CATHODE</p> | <p>STYLE 19:
 PIN 1. SOURCE 1
 2. GATE 1
 3. SOURCE 2
 4. GATE 2
 5. DRAIN 2
 6. MIRROR 2
 7. DRAIN 1
 8. MIRROR 1</p> | <p>STYLE 20:
 PIN 1. SOURCE (N)
 2. GATE (N)
 3. SOURCE (P)
 4. GATE (P)
 5. DRAIN
 6. DRAIN
 7. DRAIN
 8. DRAIN</p> |
| <p>STYLE 21:
 PIN 1. CATHODE 1
 2. CATHODE 2
 3. CATHODE 3
 4. CATHODE 4
 5. CATHODE 5
 6. COMMON ANODE
 7. COMMON ANODE
 8. CATHODE 6</p> | <p>STYLE 22:
 PIN 1. I/O LINE 1
 2. COMMON CATHODE/VCC
 3. COMMON CATHODE/VCC
 4. I/O LINE 3
 5. COMMON ANODE/GND
 6. I/O LINE 4
 7. I/O LINE 5
 8. COMMON ANODE/GND</p> | <p>STYLE 23:
 PIN 1. LINE 1 IN
 2. COMMON ANODE/GND
 3. COMMON ANODE/GND
 4. LINE 2 IN
 5. LINE 2 OUT
 6. COMMON ANODE/GND
 7. COMMON ANODE/GND
 8. LINE 1 OUT</p> | <p>STYLE 24:
 PIN 1. BASE
 2. EMITTER
 3. COLLECTOR/ANODE
 4. COLLECTOR/ANODE
 5. CATHODE
 6. CATHODE
 7. COLLECTOR/ANODE
 8. COLLECTOR/ANODE</p> |
| <p>STYLE 25:
 PIN 1. VIN
 2. N/C
 3. REXT
 4. GND
 5. IOUT
 6. IOUT
 7. IOUT
 8. IOUT</p> | <p>STYLE 26:
 PIN 1. GND
 2. dv/dt
 3. ENABLE
 4. ILIMIT
 5. SOURCE
 6. SOURCE
 7. SOURCE
 8. VCC</p> | <p>STYLE 27:
 PIN 1. ILIMIT
 2. OVLO
 3. UVLO
 4. INPUT+
 5. SOURCE
 6. SOURCE
 7. SOURCE
 8. DRAIN</p> | <p>STYLE 28:
 PIN 1. SW_TO_GND
 2. DASIC OFF
 3. DASIC_SW_DET
 4. GND
 5. V_MON
 6. VBULK
 7. VBULK
 8. VIN</p> |
| <p>STYLE 29:
 PIN 1. BASE, DIE #1
 2. EMITTER, #1
 3. BASE, #2
 4. EMITTER, #2
 5. COLLECTOR, #2
 6. COLLECTOR, #2
 7. COLLECTOR, #1
 8. COLLECTOR, #1</p> | <p>STYLE 30:
 PIN 1. DRAIN 1
 2. DRAIN 1
 3. GATE 2
 4. SOURCE 2
 5. SOURCE 1/DRAIN 2
 6. SOURCE 1/DRAIN 2
 7. SOURCE 1/DRAIN 2
 8. GATE 1</p> | | |

DOCUMENT NUMBER:	98ASB42564B	Electronic versions are uncontrolled except when accessed directly from the Document Repository. Printed versions are uncontrolled except when stamped "CONTROLLED COPY" in red.
DESCRIPTION:	SOIC-8 NB	PAGE 2 OF 2

ON Semiconductor and  are trademarks of Semiconductor Components Industries, LLC dba ON Semiconductor or its subsidiaries in the United States and/or other countries. ON Semiconductor reserves the right to make changes without further notice to any products herein. ON Semiconductor makes no warranty, representation or guarantee regarding the suitability of its products for any particular purpose, nor does ON Semiconductor assume any liability arising out of the application or use of any product or circuit, and specifically disclaims any and all liability, including without limitation special, consequential or incidental damages. ON Semiconductor does not convey any license under its patent rights nor the rights of others.

ON Semiconductor and  are trademarks of Semiconductor Components Industries, LLC dba ON Semiconductor or its subsidiaries in the United States and/or other countries. ON Semiconductor owns the rights to a number of patents, trademarks, copyrights, trade secrets, and other intellectual property. A listing of ON Semiconductor's product/patent coverage may be accessed at www.onsemi.com/site/pdf/Patent-Marking.pdf. ON Semiconductor reserves the right to make changes without further notice to any products herein. ON Semiconductor makes no warranty, representation or guarantee regarding the suitability of its products for any particular purpose, nor does ON Semiconductor assume any liability arising out of the application or use of any product or circuit, and specifically disclaims any and all liability, including without limitation special, consequential or incidental damages. Buyer is responsible for its products and applications using ON Semiconductor products, including compliance with all laws, regulations and safety requirements or standards, regardless of any support or applications information provided by ON Semiconductor. "Typical" parameters which may be provided in ON Semiconductor data sheets and/or specifications can and do vary in different applications and actual performance may vary over time. All operating parameters, including "Typicals" must be validated for each customer application by customer's technical experts. ON Semiconductor does not convey any license under its patent rights nor the rights of others. ON Semiconductor products are not designed, intended, or authorized for use as a critical component in life support systems or any FDA Class 3 medical devices or medical devices with a same or similar classification in a foreign jurisdiction or any devices intended for implantation in the human body. Should Buyer purchase or use ON Semiconductor products for any such unintended or unauthorized application, Buyer shall indemnify and hold ON Semiconductor and its officers, employees, subsidiaries, affiliates, and distributors harmless against all claims, costs, damages, and expenses, and reasonable attorney fees arising out of, directly or indirectly, any claim of personal injury or death associated with such unintended or unauthorized use, even if such claim alleges that ON Semiconductor was negligent regarding the design or manufacture of the part. ON Semiconductor is an Equal Opportunity/Affirmative Action Employer. This literature is subject to all applicable copyright laws and is not for resale in any manner.

PUBLICATION ORDERING INFORMATION

LITERATURE FULFILLMENT:

Email Requests to: orderlit@onsemi.com

ON Semiconductor Website: www.onsemi.com

TECHNICAL SUPPORT

North American Technical Support:
Voice Mail: 1 800-282-9855 Toll Free USA/Canada
Phone: 011 421 33 790 2910

Europe, Middle East and Africa Technical Support:

Phone: 00421 33 790 2910

For additional information, please contact your local Sales Representative

