

Series PVA13N

Microelectronic Power IC

HEXFET® Power MOSFET Photovoltaic Relay
Single-Pole, Normally-Open, 0-100V AC/DC, 375mA

General Description

The PVA13 Series AC Relay (PVA) is a single-pole, normally open, solid-state replacement for electromechanical relays used for general purpose switching of analog signals. It utilizes International Rectifier's HEXFET power MOSFETs as the output switches, driven by an integrated circuit photovoltaic generator of novel construction. The output switch is controlled by radiation from a GaAlAs light emitting diode (LED), which is optically isolated from the photovoltaic generator.

The PVA13 Series overcomes the limitations of both conventional electromechanical and reed relays by offering the solid state advantages of long life, fast operating speed, low pick up power, bounce-free operation, low thermal offset voltages and miniature package. These advantages allow product improvement and design innovations in many applications such as process control, multiplexing, automatic test equipment and data acquisition.

The PVA13 can switch analog signals from thermocouple level to 100 Volts peak AC or DC polarity. Signal frequencies into the RF range are easily controlled and switching rates up to 450Hz are achievable. The extremely small thermally generated offset voltages allow increased measurement accuracies.

These relays are packaged in 8-pin, molded DIP packages and available with either thru-hole or surface-mount ("gull-wing") leads, in plastic shipping tubes.

Applications

- Process Control
- Data Acquisition
- Test Equipment
- Multiplexing and Scanning

Features

- Bounce-Free Operation
- 10^{10} Off-State Resistance
- 1,000 V/ μ sec dv/dt
- 5 mA Input Sensitivity
- 4,000 V_{RMS} I/O Isolation
- Solid-State Reliability
- UL Recognized
- ESD Tolerance:
 - 4000V Human Body Model
 - 500V Machine Model

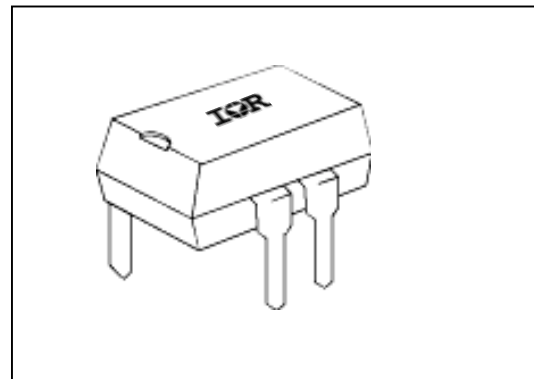

Part Identification

PVA1352N	thru-hole
PVA1354N	
PVA1352NS	surface-mount (gull-wing)
PVA1354NS	

(HEXFET is the registered trademark for International Rectifier Power MOSFETs)

Series PVA13N

International
IR Rectifier

Electrical Specifications (-40°C ≤ T_A ≤ +85°C unless otherwise specified)

INPUT CHARACTERISTICS	PVA1352N	PVA1354N	Units
Minimum Control Current (see figures 1 and 2) For 325mA Continuous Load Current For 370mA Continuous Load Current For 190mA Continuous Load Current	2 5 5		DC mA@25°C mA@40°C mA@85°C
Maximum Control Current for Off-State Resistance at 25°C	10		µA(DC)
Control Current Range (Caution: current limit input LED. See figure 6)	2.0 to 25		mA(DC)
Maximum Reverse Voltage	7.0		V(DC)

OUTPUT CHARACTERISTICS	PVA1352N	PVA1354N	Units
Operating Voltage Range	0 to ± 100		V _(peak)
Maximum Load Current 40°C, I _{LED} 5mA	375		mA(DC)
Response Time @25°C (see figures 7 and 8) Maximum T _(on) @ 12mA Control, 50 mA Load, 50 VDC Maximum T _(off) @ 12mA Control, 50 mA Load, 50 VDC	150 125		µs µs
Maximum On-state Resistance 25°C (Pulsed) (figure 4) 50 mA Load, 5mA Control	5		Ω
Minimum Off-state Resistance 25°C @ 80 VDC (see figure 5)	10 ⁸	10 ¹⁰	Ω
Maximum Thermal Offset Voltage @ 5.0mA Control	0.2		µvolts
Minimum Off-State dv/dt	1000		V/µs
Typical Output Capacitance (see figure 9)	11pF		@ 50VDC

GENERAL CHARACTERISTICS (PVA1352N and PVA1354N)		Units
Dielectric Strength: Input-Output	4000	V _{RMS}
Insulation Resistance: Input-Output @ 90V _{DC}	10 ¹² @ 25°C - 50% RH	Ω
Maximum Capacitance: Input-Output	1.0	pF
Max. Pin Soldering Temperature (1.6mm below seating plane, 10 seconds max.)	+260	°C
Ambient Temperature Range: Operating Storage	-40 to +85 -40 to +100	

International Rectifier does not recommend the use of this product in aerospace, avionics, military or life support applications. Users of this International Rectifier product in such applications assume all risks of such use and indemnify International Rectifier against all damages resulting from such use.

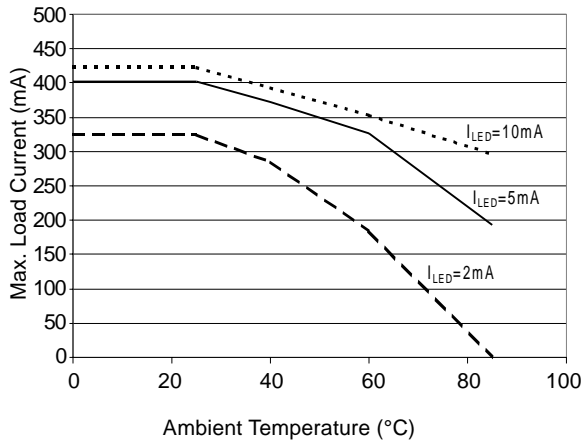

Figure 1. Current Derating Curves

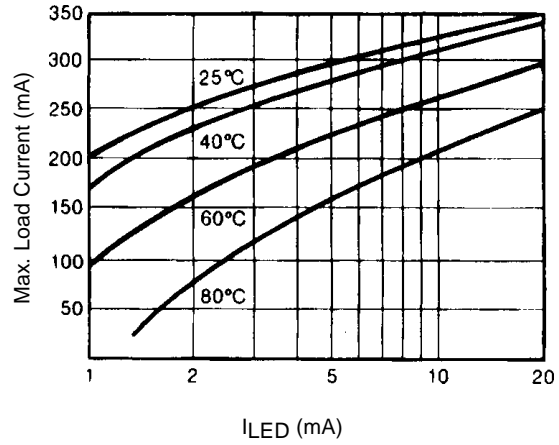

Figure 2. Typical Control Current Requirements

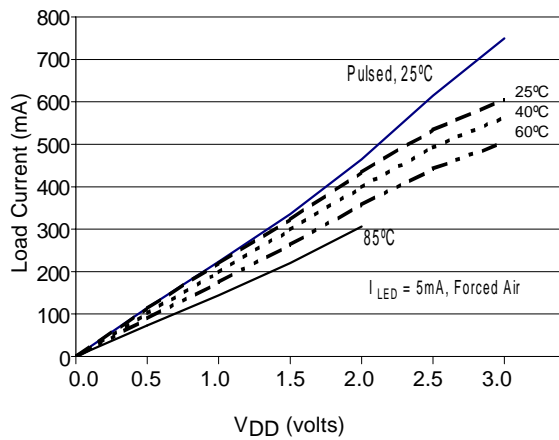

Figure 3. Typical On Characteristics

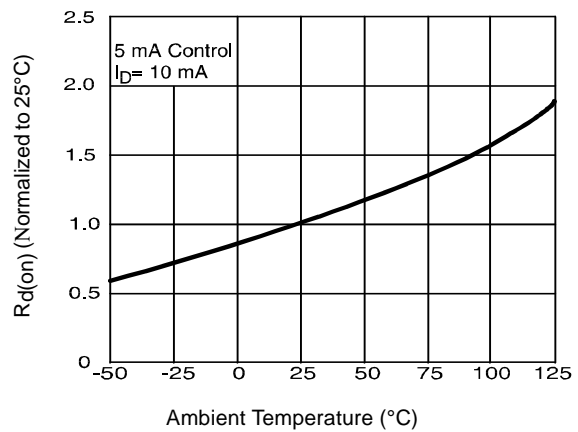

Figure 4. Typical Normalized On-Resistance

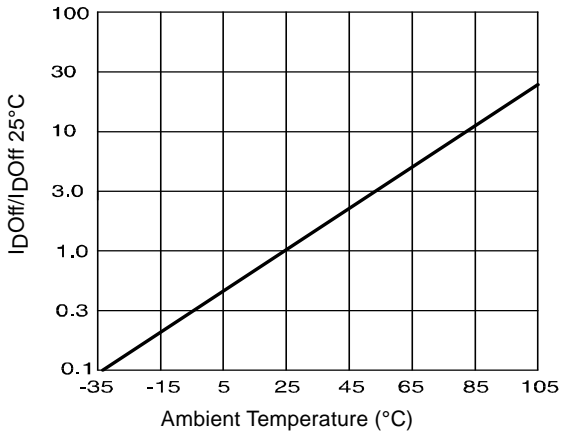

Figure 5. Normalized Off-State Leakage

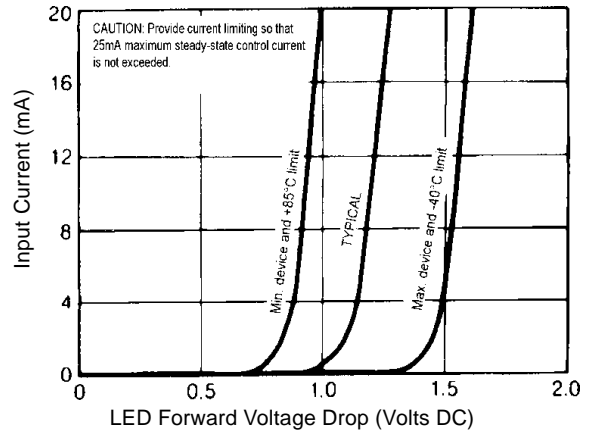

Figure 6. Input Characteristics
(Current Controlled)

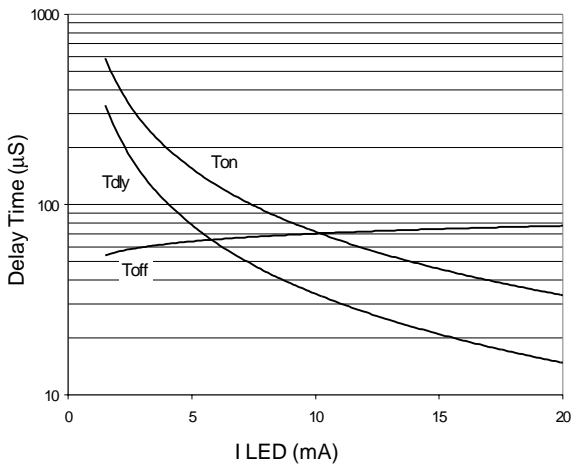

Figure 7. Typical Delay Times

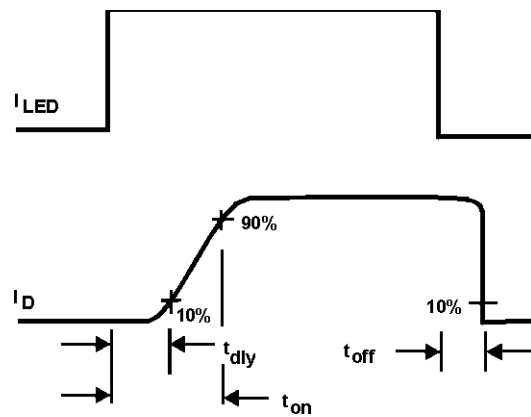

Figure 8. Delay Time Definitions

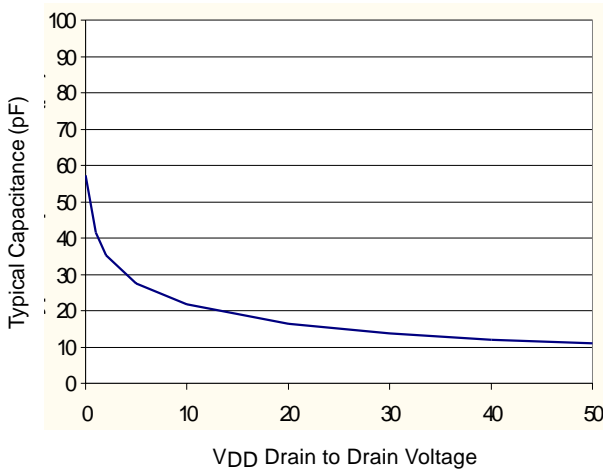
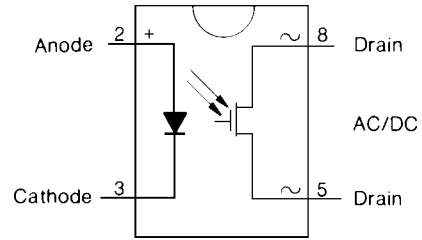
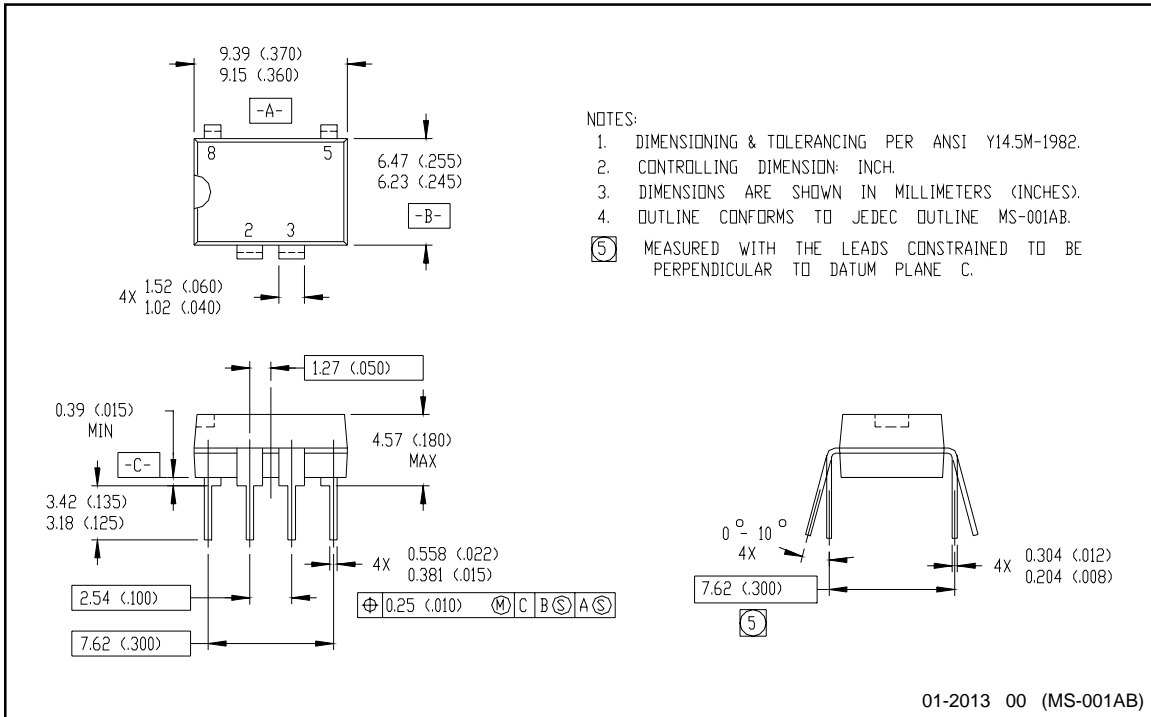

Figure 9. Typical Output Capacitance

Wiring Diagram



Case Outlines



Series PVA13N

International
IR Rectifier

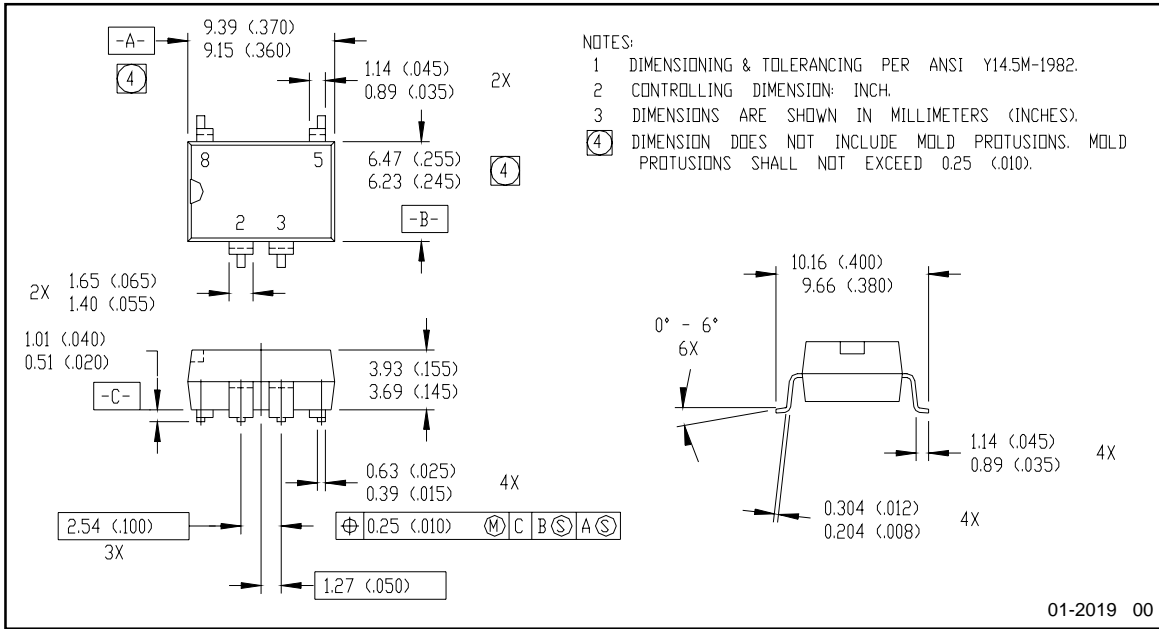

International
IR Rectifier

IR WORLD HEADQUARTERS: 233 Kansas St., El Segundo, California 90245 Tel: (310) 252-7105
Data and specifications subject to change without notice. 12/11/2003

This datasheet has been download from:

www.datasheetcatalog.com

Datasheets for electronics components.