

G5PZ

PCB Power Relay

Compact 20 A Power Relay



- 10.5 mm (W) slim size and 1 pole 16 A/20 A switching capability
- High sensitivity of 530 mW coil consumption and further saving energy with holding voltage 50%
- Min. 6.4 mm of insulation distance and 10 kV impulse withstand voltage (between coil and contacts)
- IEC60664-1 Reinforced insulation conformed



RoHS Compliant

Model Number Legend

G5PZ-□□□-□
1 2 3 4

- | | | | |
|---|--|--|--|
| 1. Number of Poles
1 : 1-pole | 2. Contact Form
A : SPST-NO (1a) | 3. Enclosure rating
None : Flux protection | 4. Classification
None : Standard
E : High-capacity |
|---|--|--|--|

Application Examples

- Air conditioners
- Home appliances
- OA equipments
- Industrial machinery

Ordering Information

Classification	Contact form	Enclosure rating	Model	Rated coil voltage	Minimum packing unit
Standard	SPST-NO (1a)	Flux protection	G5PZ-1A	5 VDC	100 pcs. / Tray
High-capacity			G5PZ-1A-E	12 VDC 24 VDC	

Note 1. When ordering, add the rated coil voltage to the model number.

Example: G5PZ-1A DC12

Rated coil voltage

However, the notation of the coil voltage on the product case as well as on the packing will be marked as □□VDC.

Ratings

Coil

Rated voltage	Item	Rated current (mA)	Coil resistance (Ω)	Must-operate voltage (V)	Must-release voltage (V)	Max. voltage (V)	Power consumption (mW)
5 VDC		106	47	75% max.	10% min.	140% (at 23°C)	Approx. 530
12 VDC		44.1	272				
24 VDC		22.1	1087				

Note 1. The rated current and coil resistance are measured at a coil temperature of 23°C with a tolerance of ±10%.

Note 2. The operating characteristics are measured at a coil temperature of 23°C.

Note 3. The "Max. voltage" is the maximum voltage that can be applied to the relay coil.

Contacts

Classification	Standard		High-capacity	
	Model		Model	
	G5PZ-1A		G5PZ-1A-E	
Item	Load			
	Resistive load			
Contact type	Single			
Contact material	Ag-alloy (Cd free)			
Rated load	16 A at 250 VAC		20 A at 250 VAC	
Rated carry current	16 A		20 A	
Max. switching voltage	250 VAC			
Max. switching current	16 A		20 A	

■ Characteristics

Classification		Standard	High-capacity
Item	Model	G5PZ-1A	G5PZ-1A-E
Contact resistance *1		100 mΩ max.	
Operate time		15 ms max.	
Release time		5 ms max.	
Insulation resistance *2		1,000 MΩ min.	
Dielectric strength	Between coil and contacts	4,000 VAC 50/60 Hz 1 min	
	Between contacts of the same polarity	1,000 VAC 50/60 Hz 1 min	
Impulse withstand voltage	Between coil and contacts	10 kV (1.2 × 50 μs)	
Vibration resistance	Destruction	10 to 55 to 10 Hz, 0.75 mm single amplitude (1.5 mm double amplitude)	
	Malfunction	10 to 55 to 10 Hz, 0.75 mm single amplitude (1.5 mm double amplitude)	
Shock resistance	Destruction	1,000 m/s ²	
	Malfunction	200 m/s ²	
Durability	Mechanical	2,000,000 operations min.	
	Electrical (resistive load)	100,000 operations at 250 VAC, 16 A	50,000 operations at 250 VAC, 20 A
Failure rate (P level) (reference value) *3		5 VDC 100 mA	
Ambient operating temperature		-40 to 70°C (with no icing or condensation)	
Ambient operating humidity		5 to 85%	
Weight		Approx. 10.5 g	

Note. Values in the above table are the initial values at 23°C.

- *1. Measurement conditions: 5 VDC, 1 A, voltage drop method
- *2. Measurement conditions: Measured at the same points as the dielectric strength using a 500 VDC ohmmeter.
- *3. This value was measured at a switching frequency of 120 operations/min.

■ Actual Load Life (Reference Values)

1. **250 VAC** Inverter load (Standard)
Inrush: 240 A (0-P, Rise Time 3 ms or more), Current 16 A, Cut off current 0 A
50,000 operations min. (at 23°C)
2. **250 VAC** Inverter load (High-capacity)
Inrush: 240 A (0-P, Rise Time 3 ms or more), Current 20 A, Cut off current 0 A
50,000 operations min. (at 23°C)

Engineering Data

Maximum Switching Capacity

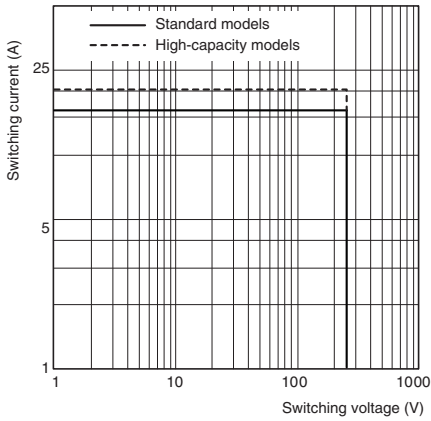

Ambient Temperature vs. Maximum Coil Voltage

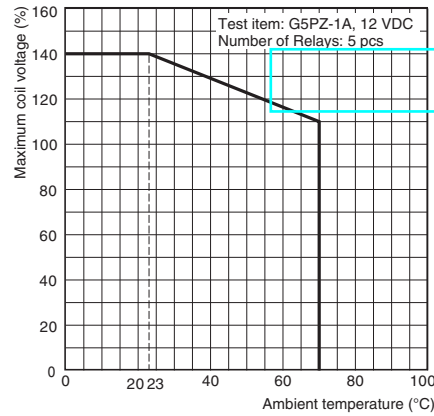

Note. The maximum coil voltage refers to the maximum value in a varying range of operating power voltage, not a continuous voltage.

Shock malfunction

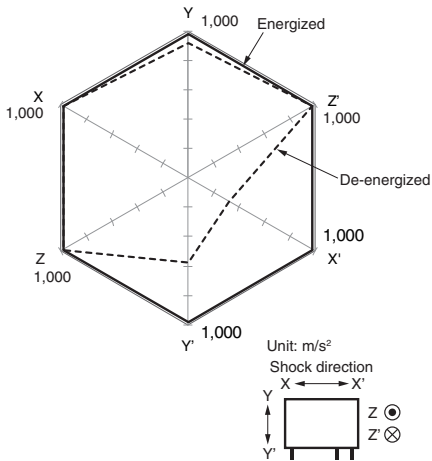

Test Item: G5PZ-1A 12 VDC
 Number of Relays: 5 pcs
 Test Method: Shock is applied 3 times in 6 directions along 3 axes and the level at which shock caused malfunction is measured.
 The energized voltage is 100% of the rated voltage.
 Rating: 200 m/s²

G5PZ

Dimensions

CAD Data Please visit our website, which is noted on the last page.

(Unit: mm)

G5PZ

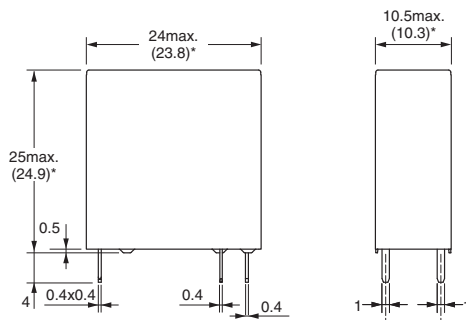

PCB Mounting Holes
 (Bottom View)
 Tolerance: ±0.1 mm

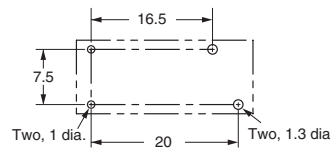

Terminal Arrangement/ Internal Connections
 (Bottom View)

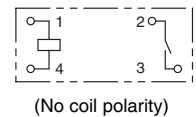

CAD Data

■ Approved Standards

The approval rating values for overseas standards are different from the performance values determined individually. Confirm the values before use.

- **UL Recognized:**  (File No. E41515)
- **CSA Certified:**  (File No. LR31928)

Model	Contact form	Coil ratings	Contact ratings	Number of test operations
G5PZ-1A	SPST-NO(1a)	5 to 24 VDC	16 A, 277 VAC (Resistive) 70°C	6,000
G5PZ-1A-E			20 A, 277 VAC (Resistive) 70°C	50,000

- **EN/IEC, VDE Certified:**  (Certificate No. 40042966)

Model	Contact form	Coil ratings	Contact ratings	Number of test operations
G5PZ-1A	SPST-NO(1a)	5, 12, 24 VDC	16 A, 250 V AC (Resistive) 70°C	6,000

- **EN/IEC, TÜV Certified:**  (Certificate No. R50408241)

Model	Contact form	Coil ratings	Contact ratings	Number of test operations
G5PZ-1A-E	SPST-NO(1a)	5, 12, 24 VDC	20 A, 250 VAC (cosφ=1) 70°C	50,000

- **CQC Certified:**  (Certificate No. CQC15002133270)

Model	Contact form	Coil ratings	Contact ratings	Number of test operations
G5PZ-1A	SPST-NO(1a)	5, 12, 24 VDC	16 A, 250 VAC (cosφ=1) 70°C	6,000
G5PZ-1A-E			20 A, 250 VAC (cosφ=1) 70°C	50,000

Creepage distance	9.5 mm min.
Clearance distance	6.4 mm min.
Insulation material group	III a
Type of insulation coil-contact circuit open contact circuit	Reinforced (Standard : Pollution degree 2) (High-capacity : Pollution degree 3)
Type of disconnection open contact circuit	Micro disconnection
Rated Insulation voltage	250 VAC
Pollution degree	2
Rated voltage system	250 V
Over voltage category	III
Category of protection according to IEC 61810-1	RT II
Tracking resistance according to IEC 60112	PTI 250 V min. (housing parts)
Flammability class according to UL94	V-0

■Precautions

●Please refer to “PCB Relays Common Precautions” for correct use.

Correct Use

●Coil Voltage Reduction (Holding Voltage) after Relay Operation

- If the coil voltage is reduced to the holding voltage after Relay operation, first apply the rated voltage to the coil for at least 100 ms, as shown below.
- A voltage of at least 50% of the rated voltage is required for the coil holding voltage. Do not allow voltage fluctuations to cause the coil holding voltage to fall below this level.

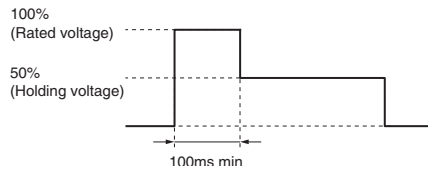

	Applied coil voltage	Coil resistance*	Power consumption
Rated voltage	100%	475 Ω (5 VDC) 272 Ω (12 VDC)	Approx. 530 mW
Holding voltage	50%	1087 Ω (24 VDC)	Approx. 133 mW

* The coil resistance were measured at a coil temperature of 23°C with tolerances of ± 10%.

G
5
P
Z

Please check each region's Terms & Conditions by region website.

OMRON Corporation

Electronic and Mechanical Components Company

Regional Contact

Americas
<https://www.components.omron.com/>
Asia-Pacific
<https://ecb.omron.com.sg/>
Korea
<https://www.omron-ecb.co.kr/>

Europe
<http://components.omron.eu/>
China
<https://www.ecb.omron.com.cn/>
Japan
<https://www.omron.co.jp/ecb/>