

Switching Power Supply Type SPD 120W 3 phases DIN rail mounting

CARLO GAVAZZI



- Universal AC 3 phases input full range
- Can also be used as single phase 480VAC
- Installation on DIN rail 7.5 or 15mm
- PFC as standard
- High efficiency up to 88%
- Power ready output
- Compact dimensions
- UL, cUL listed and TUV/CE

Product Description

The Switching power supplies SPD series are specially designed to be used in all automation application where the installation is on a DIN rail and compact dimensions and performance are a must.

Ordering Key

SP D 24 120 3

Model _____
 Mounting (D= Din rail) _____
 Output voltage _____
 Output power _____
 Input Type _____

Input type: 3 = three phase
 (or single phase 400/500VAC³⁾)

Approvals



Output performances

MODEL NO.	INPUT VOLTAGE	OUTPUT WATTAGE	OUTPUT VOLTAGE	OUTPUT CURRENT	EFF. (min.)	EFF. (typ.)
Single Output Models						
SPD12	3ø 340~575 VAC	120 WATTS	+ 12 VDC	10 A	85%	87%
SPD24	3ø 340~575 VAC	120 WATTS	+ 24 VDC	5 A	87%	89%

Output data

Line regulation	± 1%	Voltage fall time (I _{0nom})	150ms max
Load regulation	± 1%	Rated continuous loading	
Minimum load	0	12V Model	10A @ 12VDC/8.2A @ 14.5VDC
Turn on time (full resistive load)		24V Model	5A @ 24VDC/4.2A @ 28.5VDC
Vi nom, Io nom	150ms	Reverse voltage	
Vi nom, Io nom		12V Model	18VDC
12v model with 7000µF CAP	500ms	24V Model	35VDC
Vi nom, Io nom		Capacitor load	
24v model with 3500µF CAP	500ms	Vi nom Io nom 12V model	7000µF
Transient recovery time	2ms	Vi nom Io nom 24V model	3500µF
Ripple and noise	100mVpp	Voltage rise time	
Output voltage accuracy	± 1%	Vi nom Io nom	150ms
Temperature coefficient	± 0.03%/°C	Vi nom, Io nom	
Hold up time	20ms	12v model with 7000µF CAP	500ms
		Vi nom, Io nom	
		24v model with 3500µF CAP	500ms

Input data

Rated input voltage	400 - 500VAC	Power dissipation	
Voltage range		12V Model	20W
AC	340 - 575VAC	24V Model	16W
DC	480 - 820VDC	Frequency range	47- 63Hz
Rated input current		Leakage current	
(Vi : 400VAC, Io nom) Typ.	0.36A	Input-Output	0.25mA
Max.	0.5A	Input-FG	3.5mA
Inrush current			
Vi nom, Io nom	10A		

Controls and Protections

Overload	115-135%	Over voltage protection	VDC	
Input fuse	T2A/600VAC internal ¹⁾		Min.	Max.
Output short circuit	Hiccup mode	12V Model	14.5	17.4
Power ready output		24V Model	30	33
(only 24V model) On threshold	≥17.6 -19.4VDC	Internal surge voltage protection	Varistor	
Electrical isolation	500VDC	(IEC 61000-4-5)		
Contact rating at 60vdc	0.3A			

¹⁾ Fuse not replaceable by user

General data (@ nominal line, full load, 25°C)

Ambient temperature	-35°C to 71°C	MTBF (Bellcore issue 6 @ 40°C, GB)	
Derating (>61°C to +71°C)	2.5%/°C	12V Model	527000 Hours
Ambient humidity	20 ~ 90%RH	24V Model	559000 Hours
Storage	-25°C to +85°C	Case material	Metal
Protection degree	IP20	Dimensions LxWxD mm(inch)	124(4.88) x 74.3(2.92) x 118.8(4.68)
Cooling	Free air convection	Weight	800g
Pollution degree	2		

Norms and Standards

Vibration resistance	meet IEC 60068-2-6 (Mounting by rail: 10-500Hz, 2G, along X, Y, Z each Axis, 60 min for each Axis)	CCC	GB4943, GB9254, GB17625.1
Shock resistance	meet IEC 60068-2-27 (15G, 11ms, 3 Axis, 6 faces, 3 times for each face)	CE	EN 61000-6-3, EN 55022 Class B, EN 61000-3-2, EN 61000-3-3, EN 61000-6-2, EN 55024, EN 61000-4-2 Level 4, EN 61000-4-3 Level 3, EN 61000-4-4 Level 4, EN 61000-4-5 L-Level 3, L/N-FG Level 4, EN 61000-4-6 Level 3, EN 61000-4-8 Level 4, EN 61000-4-11, ENV 50204 Level 2, EN 61204-3
UL / cUL	UL508 listed, UL60950-1, Recognized, ISA 12.12.01 (Class 1, Division 2, Groups A, B, C and D)		
TUV	EN 60950-1, CB scheme EN 61558-1, EN 61558-2-17 (meet EN 60204)		

Block diagrams

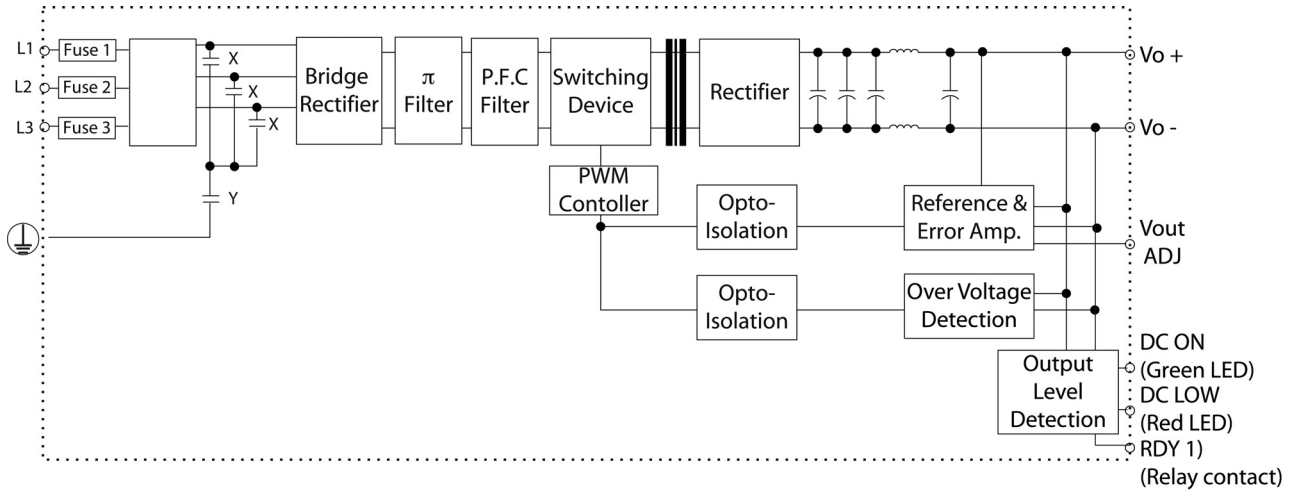

Pin Assignment and Front Controls

Pin No.	Designation	Description
1, 2	V-	Negative output terminal
3, 4	V+	Positive output terminal
5	RDY	A normal open relay contact for DC ON level control
6	RDY	(Never connect except 24V model)
7		Ground this terminal to minimize high-frequency emissions
8	 L1	Input terminals
9	L2	Input terminals
10	L3	Input terminals
	DC ON	Operation indicator LED
	DC LO	DC LOW voltage indicator LED
	Vout Adj	Trimmer-potentiometer for Vout adjustment

Derating Diagram

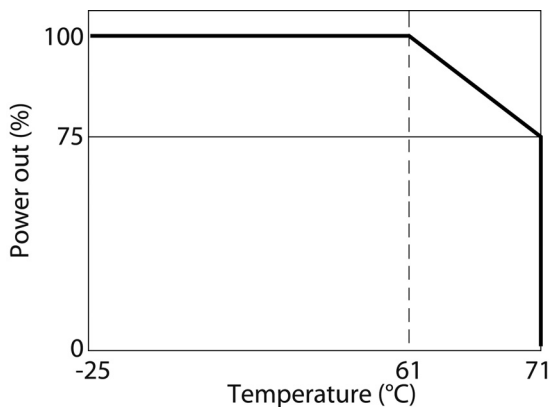

Typ. Efficiency Curve

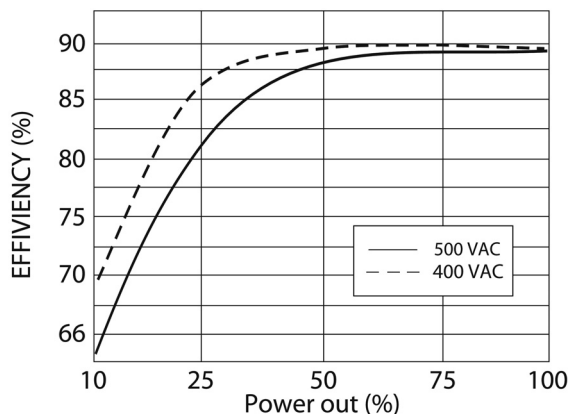

Typ. Current Limited Curve

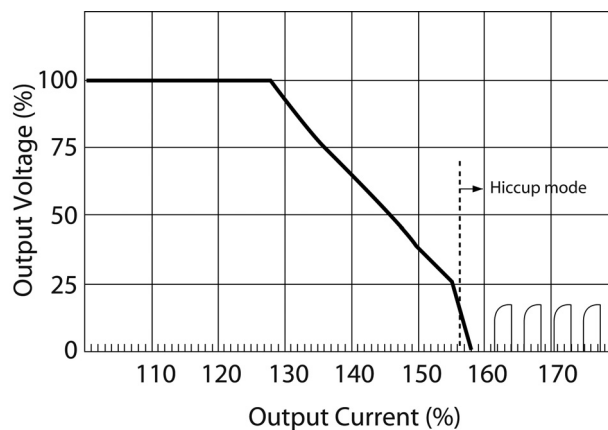
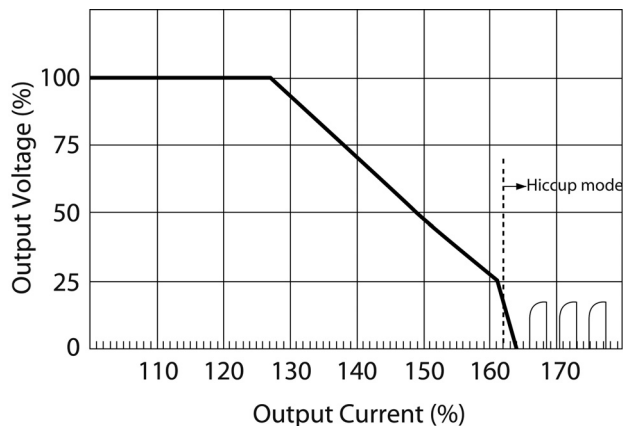

Mechanical Drawings mm/inches

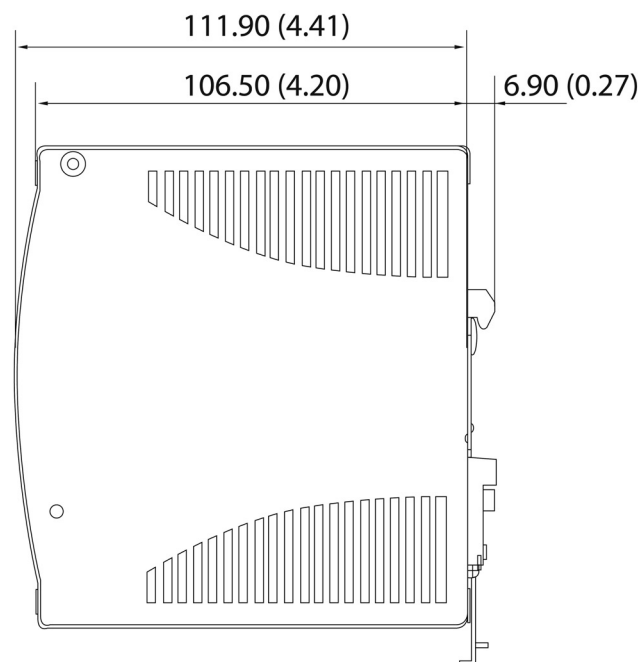
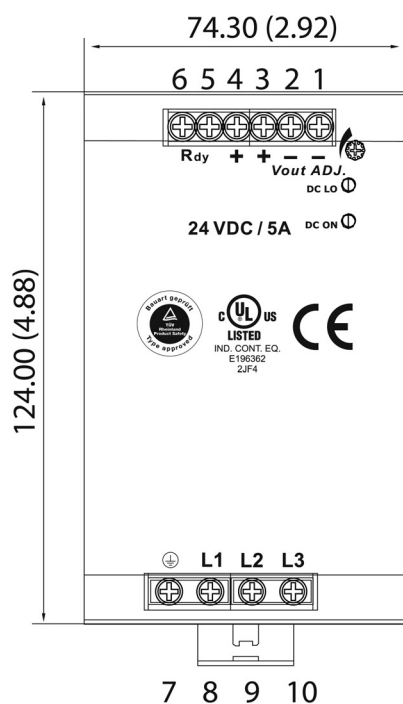

Installation

Ventilation and cooling	Normal convection All sides 25mm free space for cooling is recommended
Screw connections	10-24AWG flexible or solid cable 8mm stripping recommend
Max. torque for screws terminals	
Input terminals	1.008Nm (9.0lb-in)
Output terminals	0.616Nm (5.5lb-in)

Mouser Electronics

Authorized Distributor

Click to View Pricing, Inventory, Delivery & Lifecycle Information:

[Carlo Gavazzi:](#)

[SPD121203](#) [SPD241203](#)