

Apr.1.2020 Copyright 2020 HIROSE ELECTRIC CO., LTD. All Rights Reserved.
In case of consideration for using Automotive equipment / device which demand high reliability, kindly contact our sales window correspondents.

1> FIGURE-1 CONTACT No. MARKING (10:1)

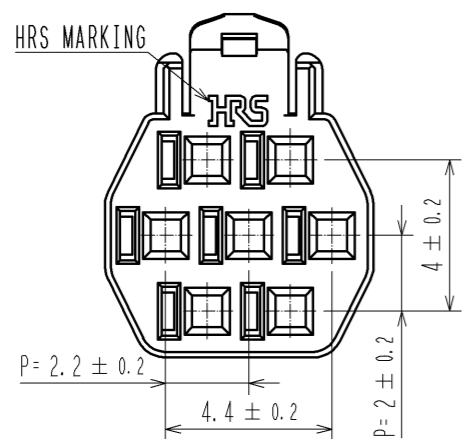
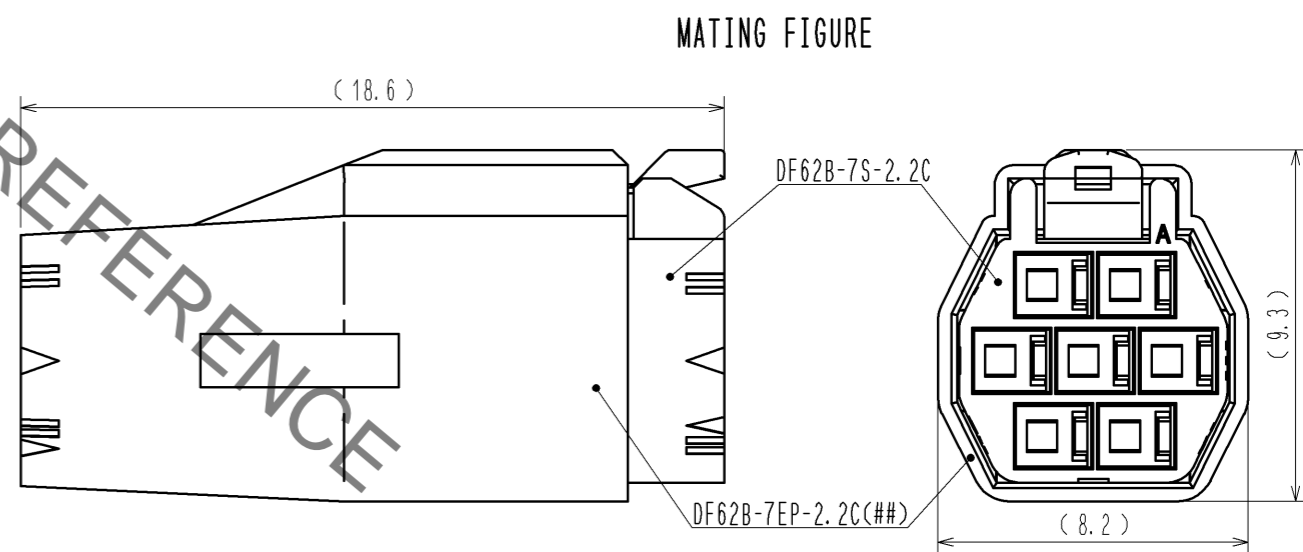
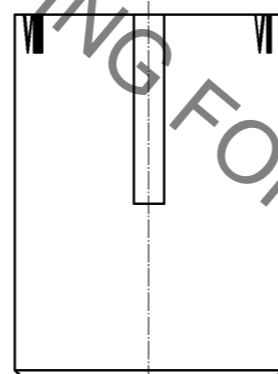
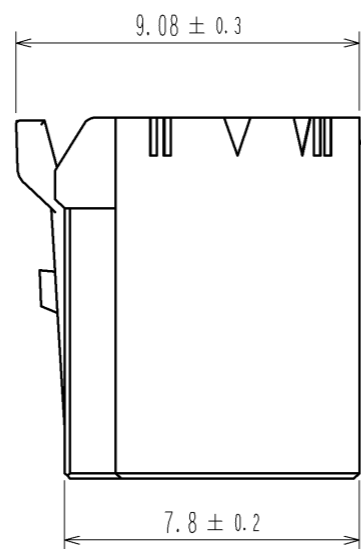
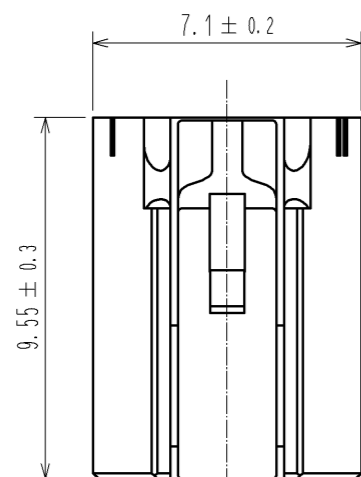
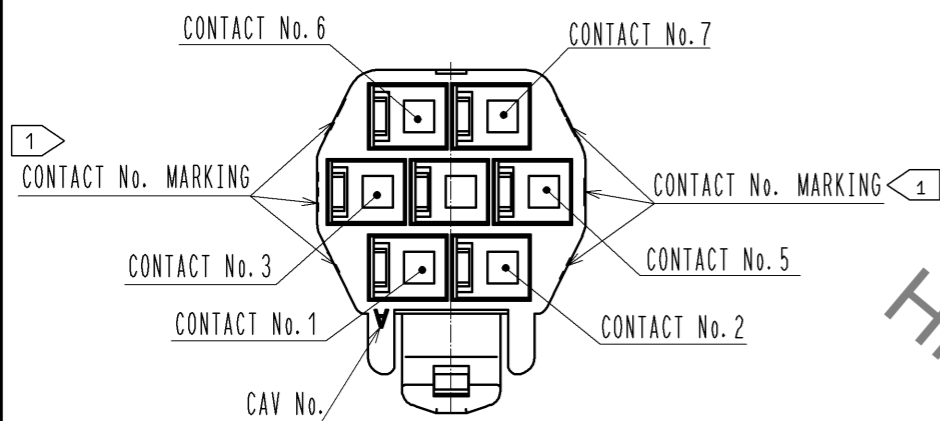
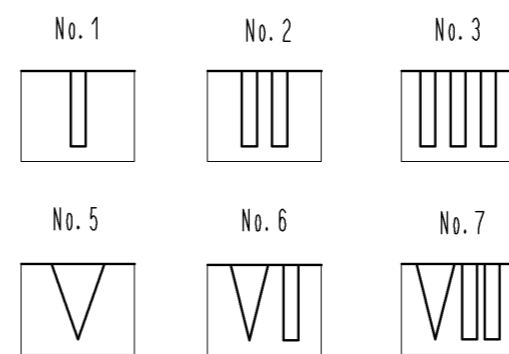

NOTE. 1> MARKINGS AT THE INDICATED POSITIONS ARE CONTACT NO. MARKING. AND SHAPES ARE SHOWN IN FIGURE-1.
2. PER PACK : 100 PIECES.
3. THE DIMENSIONS IN PARENTHESIS ARE FOR REFERENCE.

NO.		MATERIAL		FINISH . REMARKS		1		PBT		UL94V-0 (WHITE)			
UNITS		SCALE		COUNT		DESCRIPTION OF REVISIONS		DESIGNED		CHECKED		DATE	
mm		5 : 1		△									
HRS HIROSE ELECTRIC CO., LTD.		APPROVED : KI. AKIYAMA		13.05.28		DRAWING NO.		EDC3-351961-00					
		CHECKED : HK. UMEHARA		13.05.28		PART NO.		DF62B-7S-2.2C					
		DESIGNED : TS. KUMAZAWA		13.05.28		CODE NO.		CL544-0556-3-00					
		DRAWN : TS. KUMAZAWA		13.05.28									