

**Features**

- Epitaxial Planar Die Construction
- Complementary NPN Type Available (DXT651)
- Ideally Suited for Automated Assembly Processes
- Ideal for Medium Power Switching or Amplification Applications
- **Lead Free By Design/RoHS Compliant (Note 1)**
- **"Green" Device (Note 2)**



SOT89-3L

**Mechanical Data**

- Case: SOT89-3L
- Case Material: Molded Plastic, "Green" Molding Compound. UL Flammability Classification Rating 94V-0
- Moisture Sensitivity: Level 1 per J-STD-020C
- Terminals: Finish — Matte Tin annealed over Copper leadframe (Lead Free Plating). Solderable per MIL-STD-202, Method 208
- Marking Information: See Page 4
- Ordering Information: See Page 4
- Weight: 0.072 grams (approximate)

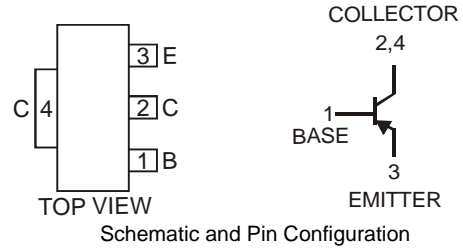

**Maximum Ratings** @  $T_A = 25^\circ\text{C}$  unless otherwise specified

Characteristic	Symbol	Value	Unit
Collector-Base Voltage	$V_{CBO}$	-80	V
Collector-Emitter Voltage	$V_{CEO}$	-60	V
Emitter-Base Voltage	$V_{EBO}$	-5	V
Continuous Collector Current	$I_C$	-3	A
Peak Pulse Collector Current	$I_{CM}$	-6	A

**Thermal Characteristics**

Characteristic	Symbol	Value	Unit
Power Dissipation (Note 3) @ $T_A = 25^\circ\text{C}$	$P_D$	1	W
Thermal Resistance, Junction to Ambient Air (Note 3) @ $T_A = 25^\circ\text{C}$	$R_{\theta JA}$	125	$^\circ\text{C/W}$
Operating and Storage Temperature Range	$T_J, T_{STG}$	-55 to +150	$^\circ\text{C}$

- Notes:
1. No purposefully added lead.
  2. Diodes Inc.'s "Green" policy can be found on our website at [http://www.diodes.com/products/lead\\_free/index.php](http://www.diodes.com/products/lead_free/index.php).
  3. Device mounted on FR-4 PCB; pad layout as shown on page 4 or in Diodes Inc. suggested pad layout document AP02001, which can be found on our website at <http://www.diodes.com/datasheets/ap02001.pdf>.

## Electrical Characteristics @ $T_A = 25^\circ\text{C}$ unless otherwise specified

Characteristic	Symbol	Min	Typ	Max	Unit	Test Conditions
<b>OFF CHARACTERISTICS (Note 4)</b>						
Collector-Base Breakdown Voltage	$V_{(BR)CBO}$	-80	—	—	V	$I_C = -100\mu\text{A}, I_E = 0$
Collector-Emitter Breakdown Voltage	$V_{(BR)CEO}$	-60	—	—	V	$I_C = -10\text{mA}, I_B = 0$
Emitter-Base Breakdown Voltage	$V_{(BR)EBO}$	-5	—	—	V	$I_E = -100\mu\text{A}, I_C = 0$
Collector Cutoff Current	$I_{CBO}$	—	—	-0.1 -10	$\mu\text{A}$	$V_{CB} = -60\text{V}, I_E = 0$ $V_{CB} = -60\text{V}, I_E = 0, T_A = 100^\circ\text{C}$
Emitter Cutoff Current	$I_{EBO}$	—	—	-0.1	$\mu\text{A}$	$V_{EB} = -4\text{V}, I_C = 0$
<b>ON CHARACTERISTICS (Note 4)</b>						
Collector-Emitter Saturation Voltage	$V_{CE(SAT)}$	—	-0.08 -0.2	-0.3 -0.6	V	$I_C = -1\text{A}, I_B = -100\text{mA}$ $I_C = -3\text{A}, I_B = -300\text{mA}$
Base-Emitter Saturation Voltage	$V_{BE(SAT)}$	—	-0.9	-1.25	V	$I_C = -1\text{A}, I_B = -100\text{mA}$
Base-Emitter Turn-On Voltage	$V_{BE(ON)}$	—	-0.8	-1	V	$V_{CE} = -2\text{V}, I_C = -1\text{A}$
DC Current Gain	$h_{FE}$	70 100 80 40	200 180 160 140	— 300 — —	—	$V_{CE} = -2\text{V}, I_C = -50\text{mA}$ $V_{CE} = -2\text{V}, I_C = -500\text{mA}$ $V_{CE} = -2\text{V}, I_C = -1\text{A}$ $V_{CE} = -2\text{V}, I_C = -2\text{A}$
<b>AC CHARACTERISTICS</b>						
Transition Frequency	$f_T$	100	145	—	MHz	$V_{CE} = -10\text{V}, I_C = -50\text{mA}, f = 100\text{MHz}$
Output Capacitance	$C_{obo}$	—	—	30	pF	$V_{CB} = -10\text{V}, f = 1\text{MHz}$
Switching Times	$t_{on}$ $t_{off}$	— —	45 200	— —	ns ns	$I_C = -500\text{mA}, V_{CC} = -10\text{V}$ $I_{B1} = I_{B2} = -50\text{mA}$

Notes: 4. Measured under pulsed conditions. Pulse width = 300 $\mu\text{s}$ . Duty cycle  $\leq 2\%$ .

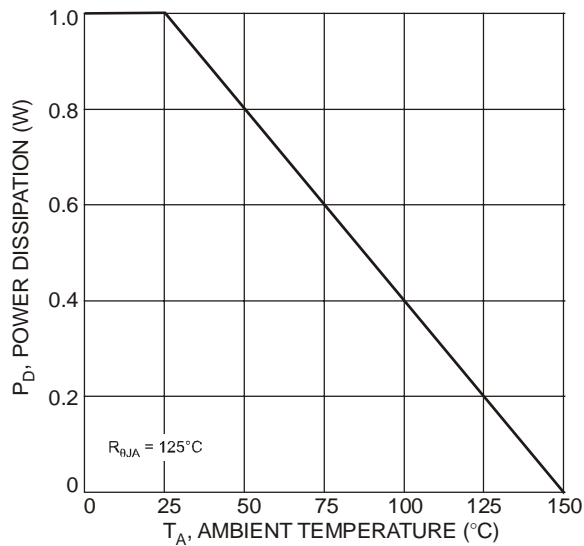

Fig. 1 Power Dissipation vs. Ambient Temperature (Note 3)

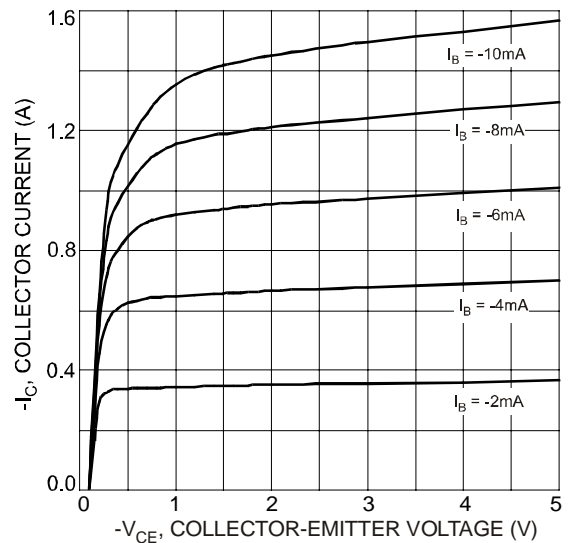

Fig. 2 Typical Collector Current vs. Collector-Emitter Voltage

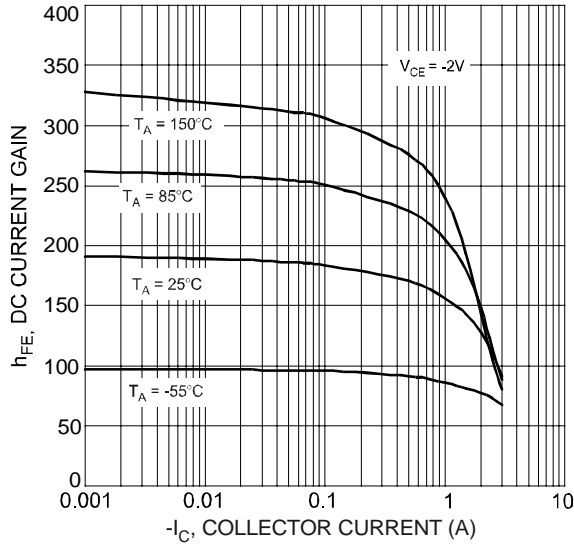

Fig. 3 Typical DC Current Gain vs. Collector Current

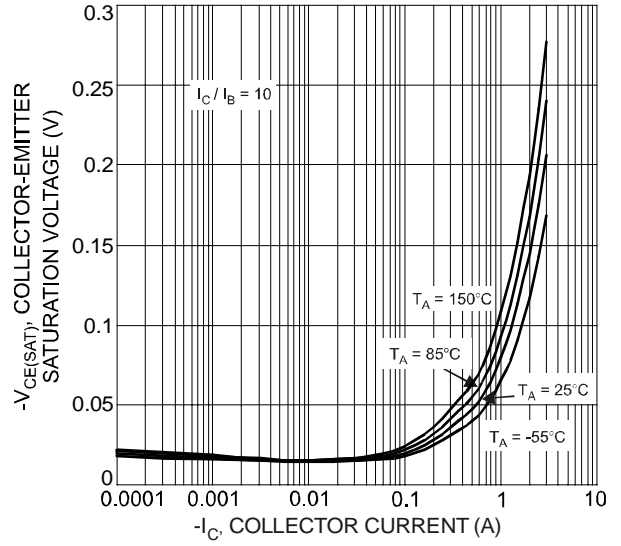

Fig. 4 Typical Collector-Emitter Saturation Voltage vs. Collector Current

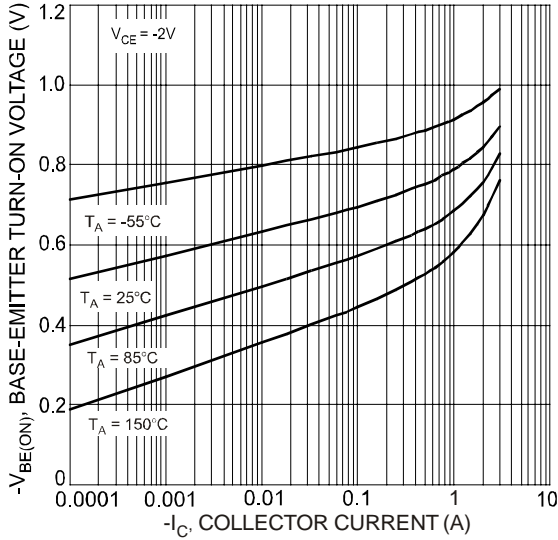

Fig. 5 Typical Base-Emitter Turn-On Voltage vs. Collector Current

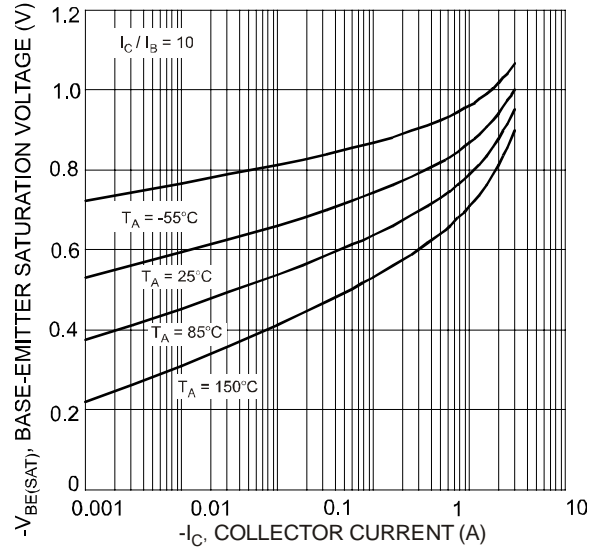

Fig. 6 Typical Base-Emitter Saturation Voltage vs. Collector Current

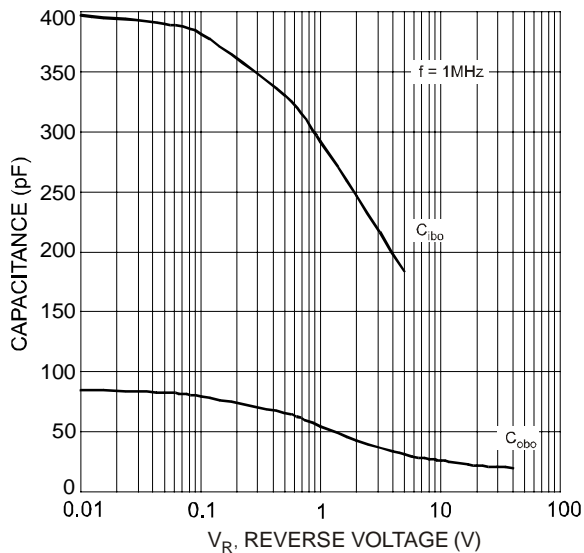

Fig. 7 Typical Capacitance Characteristics

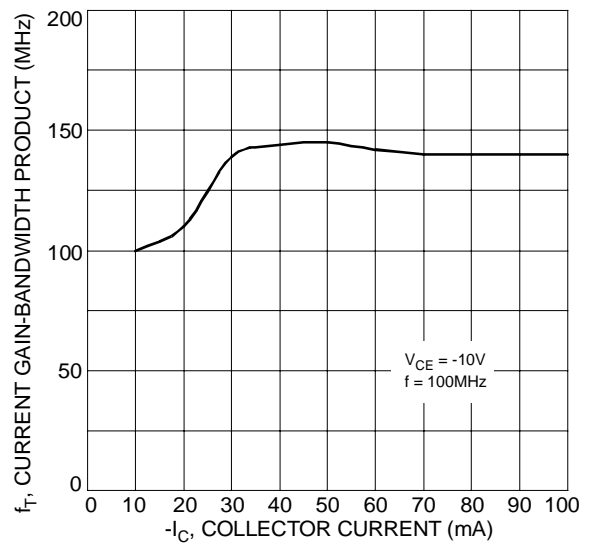

Fig. 8 Typical Gain-Bandwidth Product vs. Collector Current

## Ordering Information (Note 5)

Device	Packaging	Shipping
DXT751-13	SOT89-3L	2500/Tape & Reel

Notes: 5. For packaging details, go to our website at <http://www.diodes.com/ap02007.pdf>.

## Marking Information

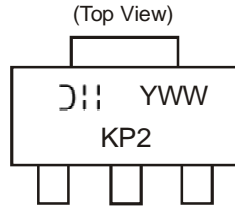

KP2 = Product Type Marking Code  
 YWW = Date Code Marking  
 Y = Last digit of year ex: 7 = 2007  
 WW = Week code 01 - 52

## Package Outline Dimensions

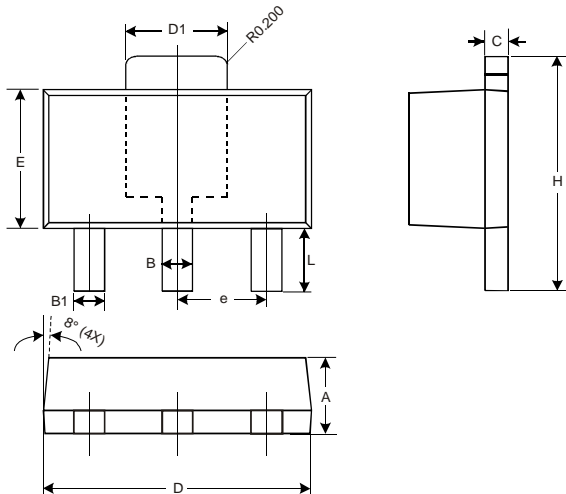

SOT89-3L			
Dim	Min	Max	Typ
A	1.40	1.60	1.50
B	0.45	0.55	0.50
B1	0.37	0.47	0.42
C	0.35	0.43	0.38
D	4.40	4.60	4.50
D1	1.50	1.70	1.60
E	2.40	2.60	2.50
e	—	—	1.50
H	3.95	4.25	4.10
L	0.90	1.20	1.05
All Dimensions in mm			

## Suggested Pad Layout

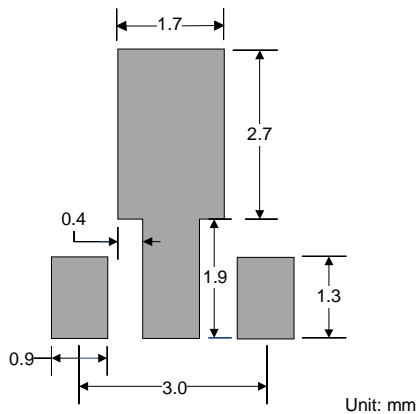

### IMPORTANT NOTICE

Diodes Incorporated and its subsidiaries reserve the right to make modifications, enhancements, improvements, corrections or other changes without further notice to any product herein. Diodes Incorporated does not assume any liability arising out of the application or use of any product described herein; neither does it convey any license under its patent rights, nor the rights of others. The user of products in such applications shall assume all risks of such use and will agree to hold Diodes Incorporated and all the companies whose products are represented on our website, harmless against all damages.

### LIFE SUPPORT

Diodes Incorporated products are not authorized for use as critical components in life support devices or systems without the expressed written approval of the President of Diodes Incorporated.

# Mouser Electronics

Authorized Distributor

Click to View Pricing, Inventory, Delivery & Lifecycle Information:

[Diodes Incorporated:](#)

[DXT751-13](#)