

# Single-pole Illuminated Rocker Switch

**Q-156**

TYPE: **IRS-1E-2C**

## SPECIFICATIONS

Contact Type: SPST  
Rating: 10A 250V AC  
Contact R: 35mΩ max  
Insulation R: 500V DC 100MΩ min  
Dielectric Strength: 1 Minute 1500V AC  
Operating Temperature: -25°C ~ +85°C  
Electrical Life: 10,000 Cycles

Outline Drawing

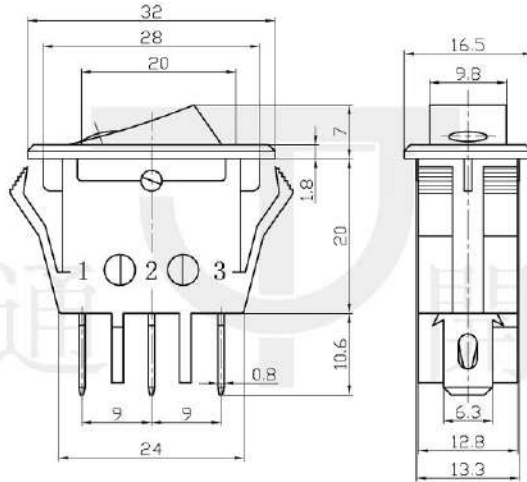

Mounting

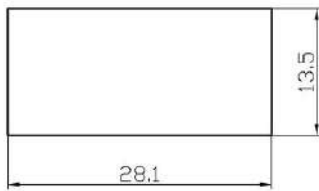

Circuitry

