

Data sheet | Item number: 2616-1353

PCB terminal block; lever; 16 mm²; Pin spacing 15 mm; 3-pole; Push-in CAGE CLAMP®; 16,00 mm²; gray

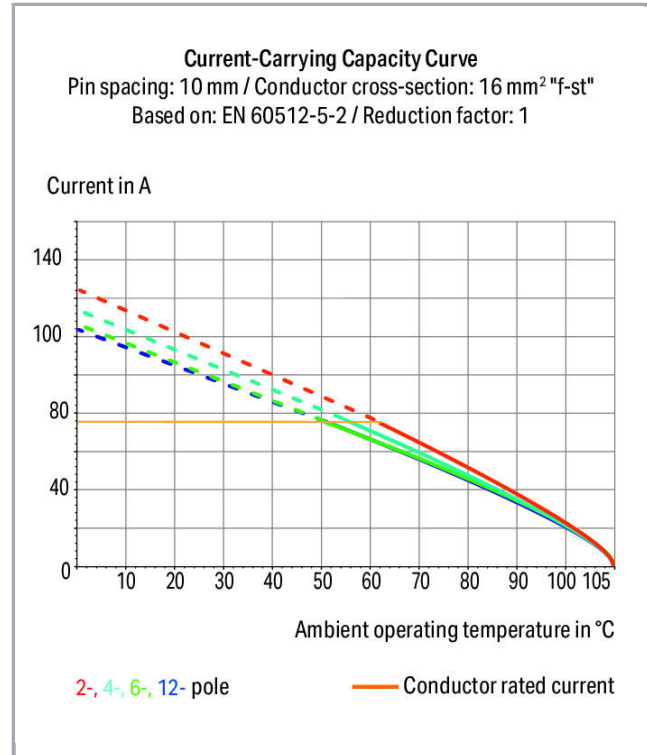

www.wago.com/2616-1353

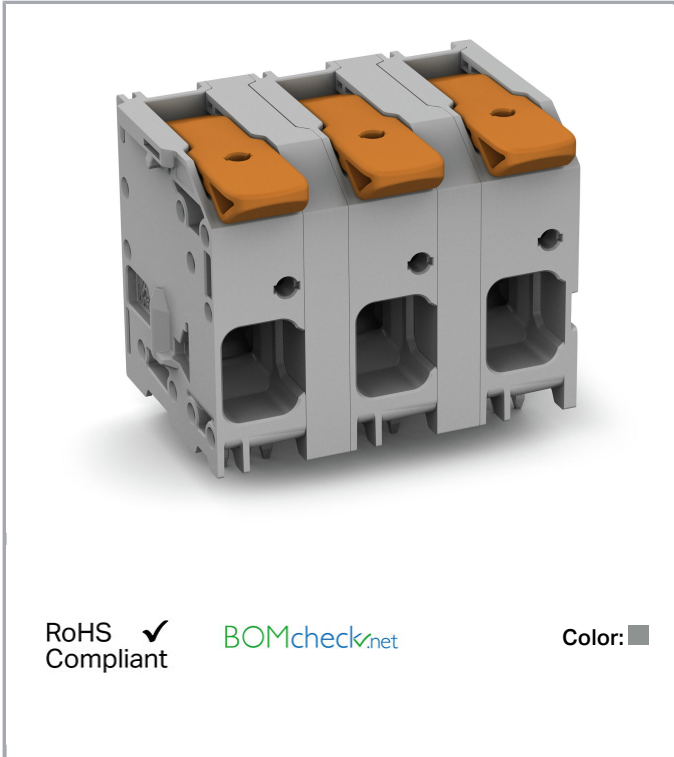

Subject to changes. Please also observe the further product documentation!

WAGO Kontakttechnik GmbH & Co. KG
Hansastr. 27
32423 Minden
Phone: +49571 887-0 | Fax: +49571 887-169
Email: info.de@wago.com | Web: www.wago.com

Do you have any questions about our products?
We are always happy to take your call at +49 (571) 887-44222.

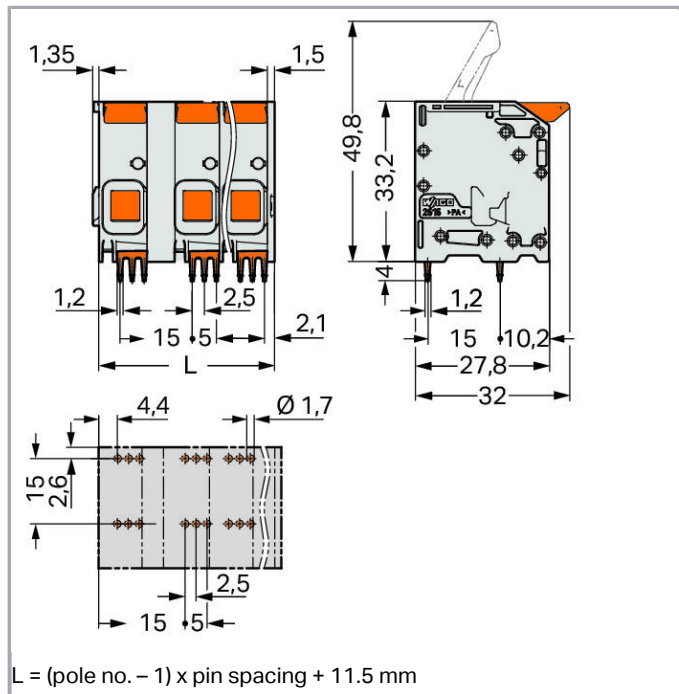

Item description

- PCB terminal blocks with levers and Push-in CAGE CLAMP® connection
- Push-in termination of solid and ferruled conductors
- Intuitive and tool-free operation
- Several clamping units can be held open simultaneously – convenient for terminating multi-core cables
- Testing can be performed both parallel and perpendicular to conductor entry

Data

Electrical data

Ratings per IEC/EN 60664-1

Ratings per	IEC/EN 60664-1
Nominal voltage (III/3)	800 V
Rated surge voltage (III/3)	8 kV
Rated voltage (III/2)	1000 V
Rated surge voltage (III/2)	8 kV
Nominal voltage (II/2)	1000 V
Rated surge voltage (II/2)	8 kV
Rated current	76 A

Subject to changes. Please also observe the further product documentation!

WAGO Kontakttechnik GmbH & Co. KG
 Hansastr. 27
 32423 Minden
 Phone: +49571 887-0 | Fax: +49571 887-169
 Email: info.de@wago.com | Web: www.wago.com

Do you have any questions about our products?
 We are always happy to take your call at +49 (571) 887-44222.

Legend (ratings)

(III / 2) ≙ Overvoltage category III / Pollution degree 2

Approvals per UL 1059

Rated voltage UL (Use Group B)	300 V
Rated current UL (Use Group B)	78 A
Rated voltage UL (Use Group C)	300 V
Rated current UL (Use Group C)	78 A
Rated voltage UL (Use Group D)	600 V
Rated current UL (Use Group D)	5 A

Connection data

Connection technology	Push-in CAGE CLAMP®
Actuation type	Lever
Solid conductor	0,75 ... 16 mm ² / 18 ... 4 AWG
Fine-stranded conductor	0,75 ... 25 mm ² / 18 ... 4 AWG
Fine-stranded conductor; with insulated ferrule	0,75 ... 16 mm ²
Fine-stranded conductor; with uninsulated ferrule	0,75 ... 16 mm ²
Fine-stranded conductor; with twin ferrule	0,75 ... 6 mm ²
Strip length	18 ... 20 mm / 0.71 ... 0.79 inch
Conductor connection direction to PCB	0°
Pole No.	3
Number of connection types	1
Number of levels	1

Geometrical Data

Pin spacing	15 mm / 0.591 inch
Width	41,5 mm / 1.634 inch
Height	37,2 mm / 1.465 inch
Height from the surface	33,2 mm / 1.307 inch
Depth	32 mm / 1.26 inch
Solder pin length	4 mm
Solder pin dimensions	1,2 x 1,2 mm
Drilled hole diameter with tolerance	1,7 ^(+0,1) mm

PCB contact

PCB contact	THT
-------------	-----

Subject to changes. Please also observe the further product documentation!

Solder pin arrangement	over the entire female connector (in-line)
Number of solder pins per potential	6

Material Data

Color	gray
Material group	I
Insulation material	Polyamide 66 (PA 66)
Flammability class per UL94	V0
Clamping spring material	Chrome nickel spring steel (CrNi)
Contact material	Electrolytic copper (E _{Cu})
Contact plating	tin-plated
Color of actuator	orange
Weight	33.7 g

Environmental Requirements



Limit temperature range	-60 ... +105 °C
-------------------------	-----------------

Commercial data

Packaging type	BOX
Country of origin	DE
GTIN	4055143860291
Customs tariff number	85369010000

Approvals / Certificates

Country specific Approvals

Logo	Approval	Additional Approval Text	Certificate name
	CSA DEKRA Certification B.V.	C22.2	70154737
	KEMA/KEUR DEKRA Certification B.V.	EN 60947-7-4	71- 108233

UL-Approvals

Certificate

Subject to changes. Please also observe the further product documentation!



Logo	Approval	Additional Approval Text	name
	cURus Underwriters Laboratories Inc.	C22.2 No. 158	E45172- 20171206

Counterpart

Downloads

Documentation

Additional Information

Technical explanations	Apr 3, 2019	pdf 3.6 MB	Download
------------------------	-------------	---------------	----------

CAD/CAE-Data

PCB Design

Symbol and Footprint 2616-1353	URL	Download
CAx data for your PCB design, consisting of "schematic symbols and PCB footprints", allow easy integration of the WAGO component into your development environment.		

Supported formats:

- Accel EDA 14 & 15
- Altium 6 to current version
- Cadence Allegro
- DesignSpark
- Eagle Libraries
- KiCad
- Mentor Graphics BoardStation
- Mentor Graphics Design Architect
- Mentor Graphics Design Expedition 99 and 2000
- OrCAD 9.X PCB and Capture
- PADS PowerPCB 3, 3.5, 4.X, and 5.X
- PADS PowerPCB and PowerLogic 3.0
- PCAD 2000, 2001, 2002, 2004, and 2006
- Pulsonix 8.5 or newer
- STL

Subject to changes. Please also observe the further product documentation!

WAGO Kontakttechnik GmbH & Co. KG
 Hansastr. 27
 32423 Minden
 Phone: +49571 887-0 | Fax: +49571 887-169
 Email: info.de@wago.com | Web: www.wago.com

Do you have any questions about our products?
 We are always happy to take your call at +49 (571) 887-44222.



- 3D STEP
- TARGET 3001!
- View Logic ViewDraw
- Quadcept
- Zuken CadStar 3 and 4
- Zuken CR-5000 and CR-8000

PCB Component Libraries (EDA), PCB CAD Library Ultra Librarian

Handling Instructions

Subject to changes. Please also observe the further product documentation!

WAGO Kontakttechnik GmbH & Co. KG
Hansastr. 27
32423 Minden
Phone: +49571 887-0 | Fax: +49571 887-169
Email: info.de@wago.com | Web: www.wago.com

Do you have any questions about our products?
We are always happy to take your call at +49 (571) 887-44222.