



# PAC50-DGB

PAC50

**PRESSURE SENSORS**

**SICK**  
Sensor Intelligence.



Illustration may differ



## Ordering information

Type	Part no.
PAC50-DGB	1062984

Other models and accessories → [www.sick.com/PAC50](http://www.sick.com/PAC50)

## Detailed technical data

### Features

<b>Medium</b>	Dry compressed air
<b>Pressure type</b>	Gauge pressure
<b>Pressure unit</b>	bar
<b>Measuring range</b>	0 bar ... 10 bar
<b>Overpressure safety</b>	15 bar
<b>Process temperature</b>	0 °C ... +60 °C
<b>Analog signal output and ohmic load R<sub>A</sub></b>	Optional, 4 mA ... 20 mA / 0 V... 10 V. Automatic detection depending on connected load or programmable. Output signals can be inverted: 20 mA ... 4 mA / 10 V ... 0 V Load resistance for current output < 600 Ohm Load resistance with current output > 3 kOhm
<b>Zero point adjustment</b>	Max. + 5 % of span
<b>Output signal</b>	PNP/NPN/Push-Pull + 4 mA ... 20 mA / 0 V ... 10 V
<b>Display</b>	LCD with LED backlight (green/red), can be rotated electronically by 180° Pressure display: 4 digits, 16 segments Pressure unit in display can be switched: bar, MPa, kPa, psi and inHg Update: 1,000, 500, 200, 100 ms (adjustable)
<b>Initialization time</b>	300 ms

### Mechanics/electronics

<b>Process connection</b>	2 x G ¼ <sup>1)</sup>
<b>Housing material</b>	Housing: polycarbonate, Buttons: TPE, DIN rail mounting: POM, seals: NBR
<b>Connection type</b>	M12 round connector x 1, 4-pin
<b>Supply voltage</b>	17 V DC ... 30 V DC
<b>Power consumption</b>	Max. 40 mA at L <sup>+</sup> = 24 VDC
<b>Electrical safety</b>	Protection class: III Overvoltage protection: 32 V DC Short-circuit protection: Q <sub>A</sub> , Q <sub>1</sub> , Q <sub>2</sub> towards M and L <sup>+</sup>

<sup>1)</sup> Bottom side: thread G ¼ female, back side: thread G ¼ female, both according to DIN ISO 1630.

<sup>2)</sup> When plugged in with a suitable mating connector.

	Reverse polarity protection: L <sup>+</sup> to M
<b>CE-conformity</b>	EMC directive: 2004/108/EC, EN 61326-2-3
<b>Weight sensor</b>	Approx. 40 g
<b>Enclosure rating</b>	IP65 / IP67 (according to IEC 60529) <sup>2)</sup>
<b>Protection class III</b>	✓
<b>RoHS certificate</b>	✓
<b>CRUus certificate</b>	✓

<sup>1)</sup> Bottom side: thread G ¼ female, back side: thread G ¼ female, both according to DIN ISO 1630.

<sup>2)</sup> When plugged in with a suitable mating connector.

## Performance

<b>Non-linearity</b>	≤ ± 0.5 %, of span (Best Fit Straight Line, BFSL) according to IEC 61298-2
<b>Accuracy</b>	≤ ± 1.5 % of the span
<b>Setting accuracy of switching outputs</b>	≤ ± 0.2 % of span
<b>Non-repeatability</b>	≤ ± 0.2 % of the span
<b>Rated temperature range</b>	+10 °C ... +60 °C

## Ambient data

<b>Ambient temperature</b>	0 °C ... +60 °C
<b>Storage temperature</b>	-20 °C ... +80 °C
<b>Relative humidity</b>	≤ 90 %
<b>Shock load</b>	Max. 30 g, xyz according to IEC 60068-2-27 (11 ms, mechanical shock)
<b>Vibration load</b>	Max. 5 g (10 ... 150 Hz), xyz, to DIN EN 60068-2-6

## Classifications

<b>ECl@ss 5.0</b>	27200620
<b>ECl@ss 5.1.4</b>	27200620
<b>ECl@ss 6.0</b>	27200620
<b>ECl@ss 6.2</b>	27200620
<b>ECl@ss 7.0</b>	27200620
<b>ECl@ss 8.0</b>	27200620
<b>ECl@ss 8.1</b>	27200620
<b>ECl@ss 9.0</b>	27200620
<b>ECl@ss 10.0</b>	27200620
<b>ECl@ss 11.0</b>	27200620
<b>ETIM 5.0</b>	EC000243
<b>ETIM 6.0</b>	EC000243
<b>ETIM 7.0</b>	EC000243
<b>UNSPSC 16.0901</b>	41112409

### Dimensional drawing (Dimensions in mm (inch))

Bottom side: thread G ¼ female, back side: thread G ¼ female

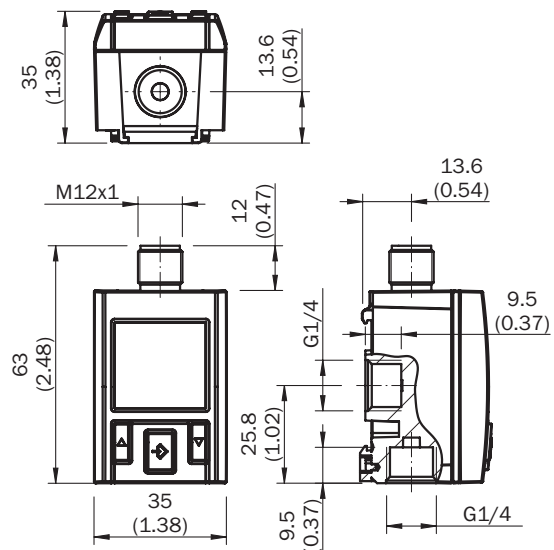

### Connection type

M12 round connector x 1, 4-pin

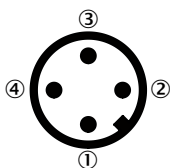

Output signals	Type code	Electrical connection	Pin assignment
2 x digital	PAC50-xxA	M12 x 1, 4 pins	L+ = 1, M = 3, Q1 = 4, Q2 = 2
1 x digital + analog	PAC50-xxB	M12 x 1, 4 pins	L+ = 1, M = 3, Q1 = 4, QA = 2
1 x IO-Link/digital + digital	PAC50-xxD	M12 x 1, 4 pins	L+ = 1, M = 3, C/Q1 = 4, Q2 = 2

### Instruction for installation



Opening in the switch panel

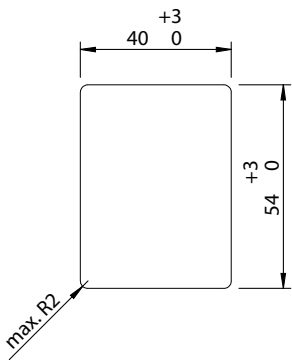

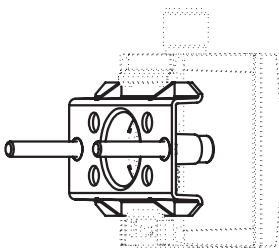

Mounting bracket

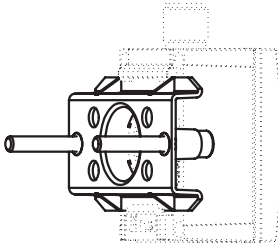



### Recommended accessories

Other models and accessories → [www.sick.com/PAC50](http://www.sick.com/PAC50)

	Brief description	Type	Part no.
<b>Mounting brackets and plates</b>			
	Wall-mounting kit; mounting element for wall-mounting of pressure switch PAC50, Mounting element: polycarbonate, screws: steel, zinc-coated	BEF-MA-WLM-NTS-PAC5	2069198
<b>Terminal and alignment brackets</b>			
	Switch panel installation set for rugged applications (shock, vibration) for installing the PAC50 pressure switch. Maximum switch panel thickness: 5 mm, Stainless steel, aluminum, plastic	BEF-MA-CTRLPX-PAC5	2099916

## SICK AT A GLANCE

SICK is one of the leading manufacturers of intelligent sensors and sensor solutions for industrial applications. A unique range of products and services creates the perfect basis for controlling processes securely and efficiently, protecting individuals from accidents and preventing damage to the environment.

We have extensive experience in a wide range of industries and understand their processes and requirements. With intelligent sensors, we can deliver exactly what our customers need. In application centers in Europe, Asia and North America, system solutions are tested and optimized in accordance with customer specifications. All this makes us a reliable supplier and development partner.

Comprehensive services complete our offering: SICK LifeTime Services provide support throughout the machine life cycle and ensure safety and productivity.

For us, that is “Sensor Intelligence.”

## WORLDWIDE PRESENCE:

Contacts and other locations –[www.sick.com](http://www.sick.com)