

40V SURFACE MOUNT SCHOTTKY BARRIER DIODE
Product Summary

- $V_R = 40V$
- $I_F = 0.52A$
- $I_R = 10\mu A$

Description and Applications

This compact SOD323 packaged Schottky diode offers users an excellent performance combination comprising high current operation, extremely low leakage and low forward voltage ensuring suitability for applications requiring efficient operation at higher temperatures (above 85°C) see Operational efficiency chart on page 4.

- DC – DC Converters
- Mobile Telecomms
- Charging circuits
- Motor control

Features and Benefits

- Low Equivalent On Resistance
- Extremely low leakage ($10\mu A @ 30V$)
- High current capability ($I_F = 0.52A$)
- Low V_F , fast switching Schottky
- ZLLS400 complements low temperature equivalent ZHCS400
- Package thermally rated to 150°C
- **Qualified to AEC-Q101 Standards for High Reliability**

Mechanical Data

- Case: SOD323
- Case Material: UL Flammability Classification Rating 94V-0
- Moisture Sensitivity: Level 1 per J-STD-020
- Terminal Connections: Cathode Band
- Terminals: Finish - Matte Tin annealed over Alloy 42 leadframe. Solderable per MIL-STD-202, Method 208
- Weight: 0.004 grams (approximate)

SOD323



Top View

Ordering Information (Note 1)

Device	Packaging	Shipping
ZLLS400TA	SOD323	3,000/Tape & Reel
ZLLS400TC	SOD323	10,000/Tape & Reel

Notes: 1. For Packaging Details, go to our website at <http://www.diodes.com>.

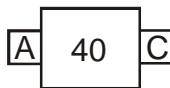
Marking Information

40 = Product Type Marking Code

Top View

Maximum Ratings @ $T_A = 25^\circ\text{C}$ unless otherwise specified

Characteristic	Symbol	Value	Units
Continuous Reverse Voltage	V_R	40	V
Continuous Forward Current	I_F	0.52	A
Peak Repetitive Forward Current Rectangular Pulse Duty Cycle	I_{FPK}	0.85	A
Non Repetitive Forward Current		$t \leq 100\mu\text{s}$	12
		$t \leq 10\text{ms}$	2.5

Thermal Characteristics

Characteristic	Symbol	Value	Unit
Power Dissipation, $T_A = 25^\circ\text{C}$ Single Die Continuous Single Die Measured at $t < 5$ secs	P_D	330 390	mW
Thermal Resistance, Junction to Ambient	$R_{\theta JA}$	379 317	$^\circ\text{C}/\text{W}$
Junction Temperature	T_J	150	$^\circ\text{C}$
Storage Temperature Range	T_{STG}	-55 to +150	$^\circ\text{C}$

Notes: 2. For a device surface mounted on 25mm x 25mm FR4 PCB with high coverage of single sided 1oz copper, in still air conditions.
3. For a device surface mounted on FR4 PCB measured at $t < 5$ secs.

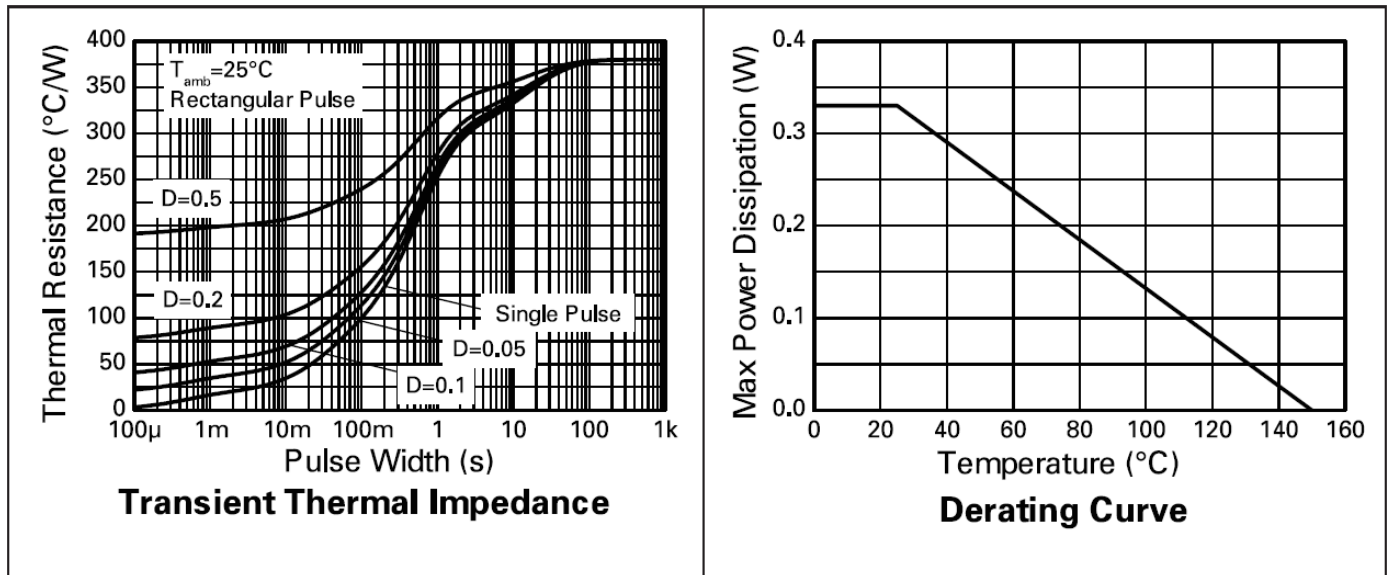

Electrical Characteristics @ $T_A = 25^\circ\text{C}$ unless otherwise specified

Characteristic	Symbol	Min	Typ	Max	Unit	Test Condition
Reverse Breakdown Voltage	$V_{(BR)R}$	40	60	-	V	$I_R = 200\mu\text{A}$
Forward Voltage (Note 4)	V_F	-	305	360	mV	$I_F = 50\text{mA}$
		-	335	390		$I_F = 100\text{mA}$
		-	395	450		$I_F = 250\text{mA}$
		-	445	500		$I_F = 400\text{mA}$
		-	550	630		$I_F = 750\text{mA}$
		-	620	710		$I_F = 1\text{A}$
		-	710	800		$I_F = 1.5\text{A}$
		-	405	-		$I_F = 400\text{mA}, T_A = 100^\circ\text{C}$
Reverse Current	I_R	-	6	10	μA	$V_R = 30\text{V}$
		-	370	-	$V_R = 30\text{V}, T_A = 85^\circ\text{C}$	
Diode Capacitance	C_D	-	15	-	pF	$f = 1\text{MHz}, V_R = 30\text{V}$
Reverse Recovery Time	t_{rr}	-	3	-	ns	Switched from $I_F = 500\text{mA}$ to
Reverse Recovery Charge	Q_{rr}	-	210	-	pC	$V_R = 5.5\text{V}$ Measured @ $I_R = 50\text{mA}$ $di/dt = 500\text{mA/ns}$ $R_{source} = 6\Omega; R_{load} = 10\Omega$

Notes: 4. Measured under pulsed conditions. Pulse width = 300 μs . Duty cycle = 2%.

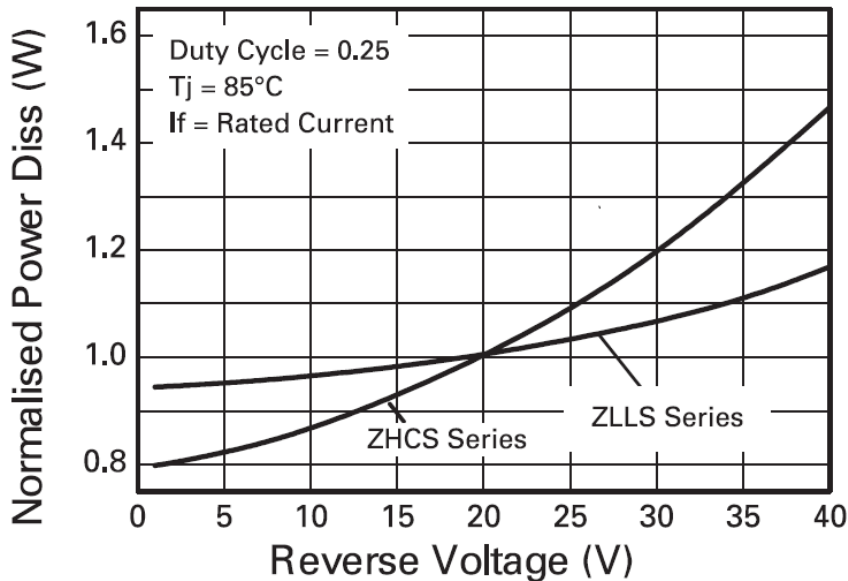
Operational efficiency chart

Operational Efficiency Example

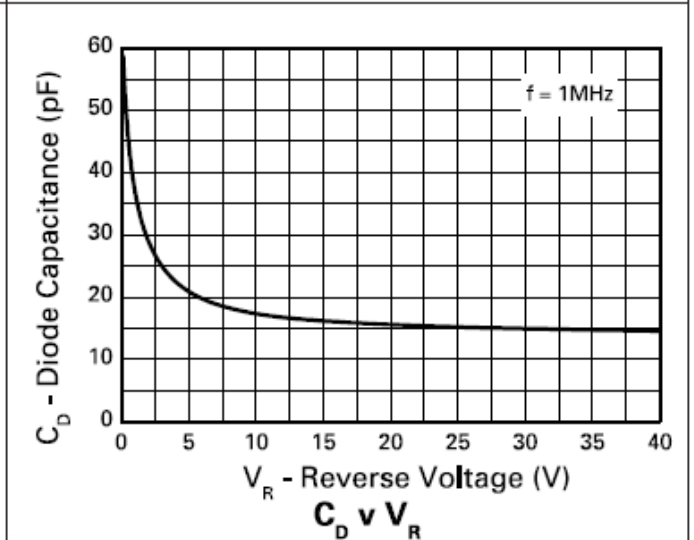
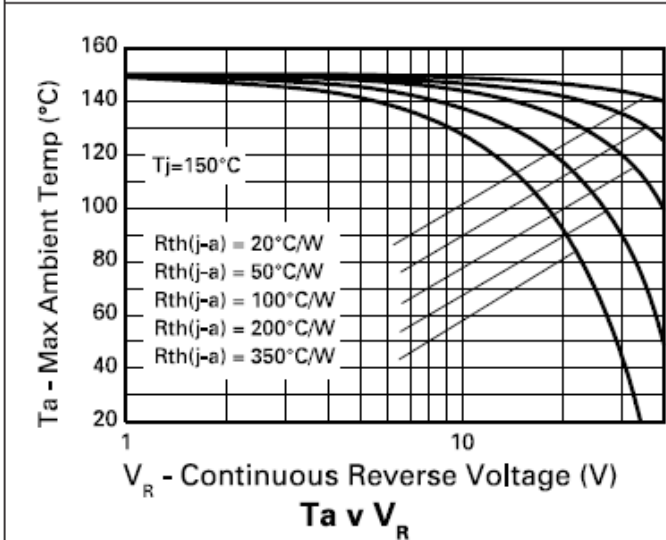
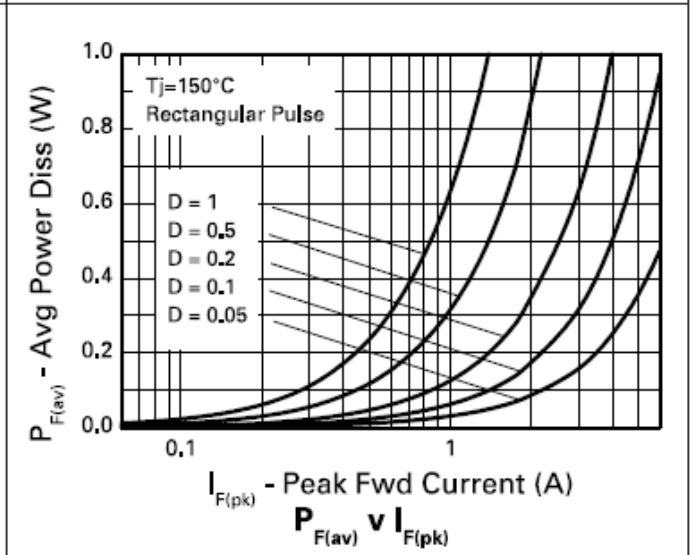
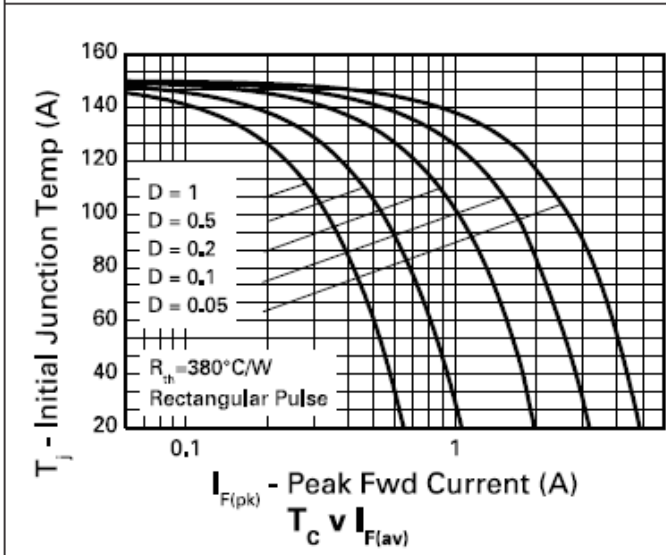
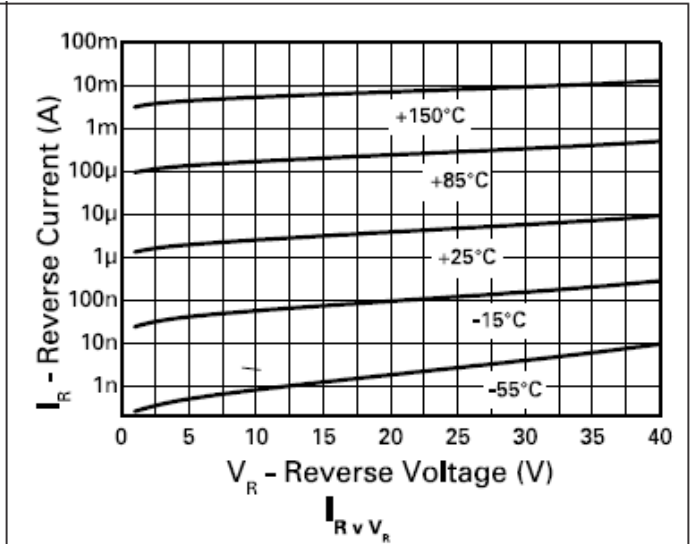
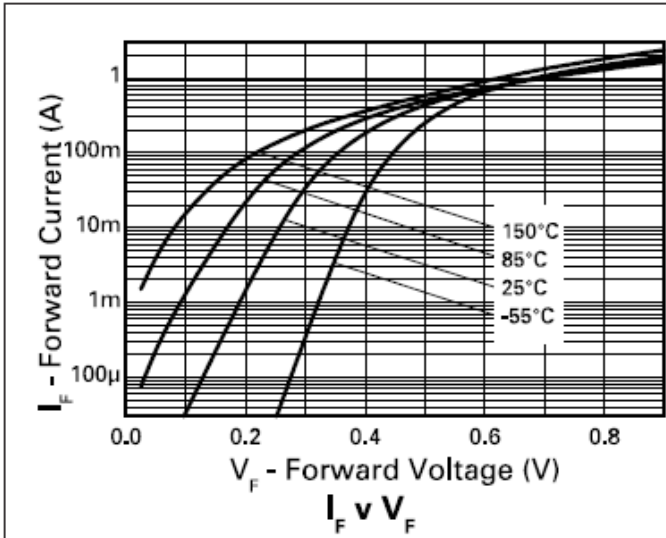
The operational efficiency chart indicates the beneficial use of the ZLLS series diodes in applications requiring higher voltage, higher temperature operation. Circuits requiring low voltage low temperature operation will benefit from using Zetex low V_F ZHCS series diodes.

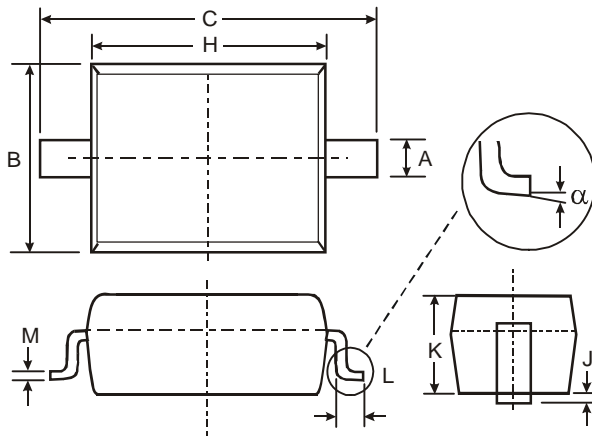

Package Outline Dimensions



SOD323		
Dim	Min	Max
A	0.25	0.35
B	1.20	1.40
C	2.30	2.70
H	1.60	1.80
J	0.00	0.10
K	1.0	1.1
L	0.20	0.40
M	0.10	0.15
α	0°	8°
All Dimensions in mm		

Suggested Pad Layout

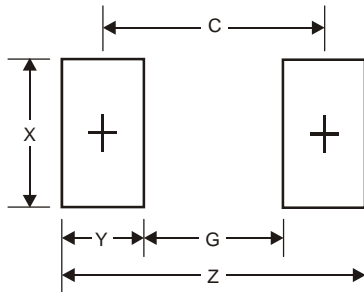

Dimensions	Value (in mm)
Z	3.75
G	1.05
X	0.65
Y	1.35
C	2.40

IMPORTANT NOTICE

DIODES INCORPORATED MAKES NO WARRANTY OF ANY KIND, EXPRESS OR IMPLIED, WITH REGARDS TO THIS DOCUMENT, INCLUDING, BUT NOT LIMITED TO, THE IMPLIED WARRANTIES OF MERCHANTABILITY AND FITNESS FOR A PARTICULAR PURPOSE (AND THEIR EQUIVALENTS UNDER THE LAWS OF ANY JURISDICTION).

Diodes Incorporated and its subsidiaries reserve the right to make modifications, enhancements, improvements, corrections or other changes without further notice to this document and any product described herein. Diodes Incorporated does not assume any liability arising out of the application or use of this document or any product described herein; neither does Diodes Incorporated convey any license under its patent or trademark rights, nor the rights of others. Any Customer or user of this document or products described herein in such applications shall assume all risks of such use and will agree to hold Diodes Incorporated and all the companies whose products are represented on Diodes Incorporated website, harmless against all damages.

Diodes Incorporated does not warrant or accept any liability whatsoever in respect of any products purchased through unauthorized sales channel. Should Customers purchase or use Diodes Incorporated products for any unintended or unauthorized application, Customers shall indemnify and hold Diodes Incorporated and its representatives harmless against all claims, damages, expenses, and attorney fees arising out of, directly or indirectly, any claim of personal injury or death associated with such unintended or unauthorized application.

Products described herein may be covered by one or more United States, international or foreign patents pending. Product names and markings noted herein may also be covered by one or more United States, international or foreign trademarks.

LIFE SUPPORT

Diodes Incorporated products are specifically not authorized for use as critical components in life support devices or systems without the express written approval of the Chief Executive Officer of Diodes Incorporated. As used herein:

A. Life support devices or systems are devices or systems which:

1. are intended to implant into the body, or
2. support or sustain life and whose failure to perform when properly used in accordance with instructions for use provided in the labeling can be reasonably expected to result in significant injury to the user.

B. A critical component is any component in a life support device or system whose failure to perform can be reasonably expected to cause the failure of the life support device or to affect its safety or effectiveness.

Customers represent that they have all necessary expertise in the safety and regulatory ramifications of their life support devices or systems, and acknowledge and agree that they are solely responsible for all legal, regulatory and safety-related requirements concerning their products and any use of Diodes Incorporated products in such safety-critical, life support devices or systems, notwithstanding any devices- or systems-related information or support that may be provided by Diodes Incorporated. Further, Customers must fully indemnify Diodes Incorporated and its representatives against any damages arising out of the use of Diodes Incorporated products in such safety-critical, life support devices or systems.

Copyright © 2012, Diodes Incorporated

www.diodes.com

Mouser Electronics

Authorized Distributor

Click to View Pricing, Inventory, Delivery & Lifecycle Information:

[Diodes Incorporated:](#)

[ZLLS400TA](#)