

Features

Unregulated Converters

- +20/-5V & +15/-3V asymmetric outputs for SiC driver applications
- Qualified with 65kV/ μ s @ Vcommon mode =1KV
- +15/-9V asymmetric outputs for IGBT driver applications
- Pot-core transformer with separated windings
- High 6.4kVDC isolation in compact SIP7 size
- Low isolation capacitance (10pF max.)
- Optional continuous short circuit protected
- IEC/EN62368-1 certified, UL pending



RxxP2xxyy

**2 Watt
SIP7 for
SiC and IGBT
Application's**



Description

High slew rate SiC transistor drivers require an isolated asymmetric supply of +20/-5V or +15/-3V with high isolation voltage and low isolation capacitance. The RxxPxyyD series have been specially designed to fulfill this demanding requirement with 6400VDC isolation and <10pF isolation capacitance. The DC/DC converters can be used with equal power (1W + 1W) or equal current (1.6W + 0.4W) driver applications as the dual outputs feature automatic power sharing. The internal transformer uses a pot-core to physically separate the input and output windings, yet the converter still fits into an industry standard SIP7 case. Input voltage options of 5, 12, 15 or 24V are available and the RxxP2xxyyD series is safety certified to the latest UL/IEC62368 standard.

Selection Guide

Part Number	Input Voltage [VDC]	Output Voltage [VDC]	Output Current [mA]	Efficiency typ. [%]	max. Capacitive Load ⁽¹⁾ [μ F]
R12P21503D	12	+15/-3	+93/-185	84	150/680
R15P21503D	15	+15/-3	+93/-185	81	150/680
R24P21503D	24	+15/-3	+66/-333	82	150/680
R05P21509D	5	+15/-9	+67/-111	82	\pm 330
R12P21509D	12	+15/-9	+67/-111	84	\pm 330
R24P21509D	24	+15/-9	+67/-111	86	\pm 330
R05P22005D	5	+20/-5	50/-200 +/-80	82 83	47/680
R12P22005D	12	+20/-5	50/-200 +/-80	82	47/680
R15P22005D	15	+20/-5	50/-200 +/-80	83 84	47/680
R24P22005D	24	+20/-5	50/-200 +/-80	84 85	47/680

Notes:

Note1: Max. capacitive load is tested at nominal input voltage and full load

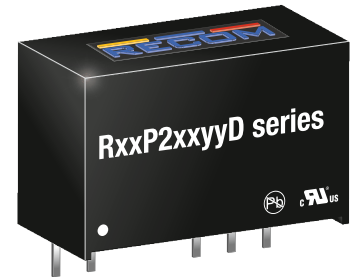

UL60950-1 certified
CAN/CSA-C22.2 No. 60950-1-07 certified
UL62368-1 certified
CAN/CSA-C22.2 No. 62368-1-14 certified
IEC/EN62368-1 certified
CB Report

Model Numbering

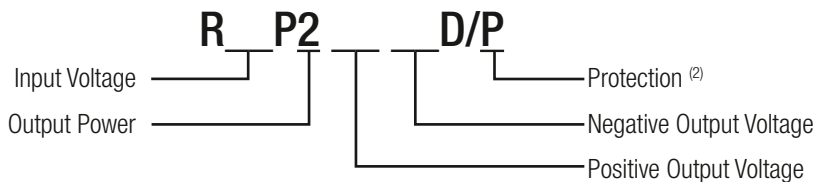

Notes:

Note2: add suffix "/P" for continuous short circuit protection (not available for RxxP21503D) without suffix no short circuit protection



www.recom-power.com/eval-ref-boards

www.recom-power.com/bier

Specifications (measured @ Ta= 25°C, nominal Input and full load after warm-up time unless otherwise noted)

Parameter	Condition		Min.	Typ.	Max.
Internal Input Filter			capacitor type		
Input Voltage Range	nom. Vin=	5Vin	4.5VDC		5.5VDC
		12Vin	10.8VDC		13.2VDC
		15Vin	13.5VDC		16.5VDC
		24Vin	21.6VDC		26.4VDC
Minimum Load			0%		
Start-up Time				5ms	
Internal Operating Frequency			20kHz	50kHz	
Output Ripple and Noise	20MHz bandwidth				200mVp-p

Efficiency vs. Load

RxxP21503D Series

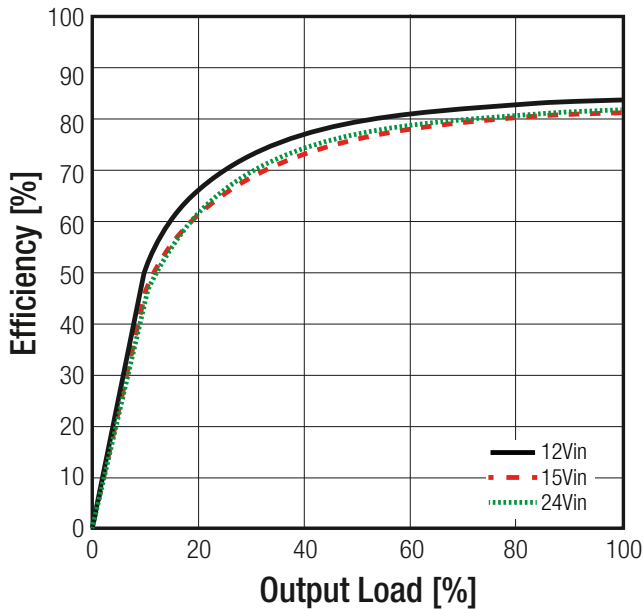

RxxP21509D Series

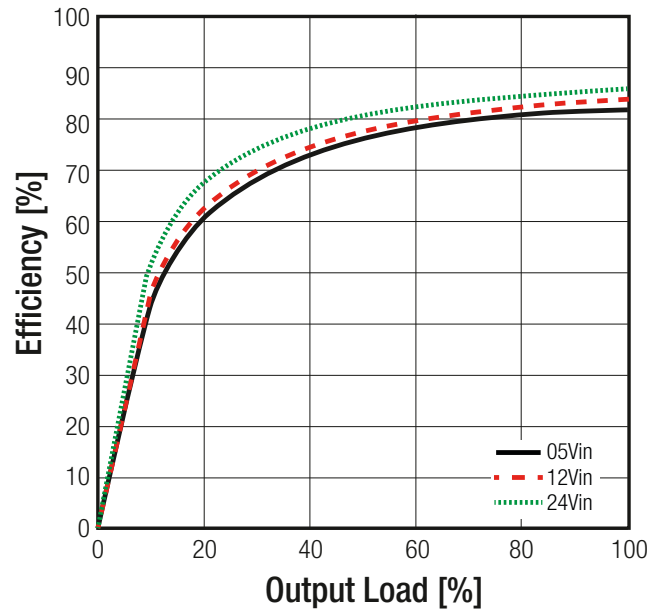

RxxP22005D Series

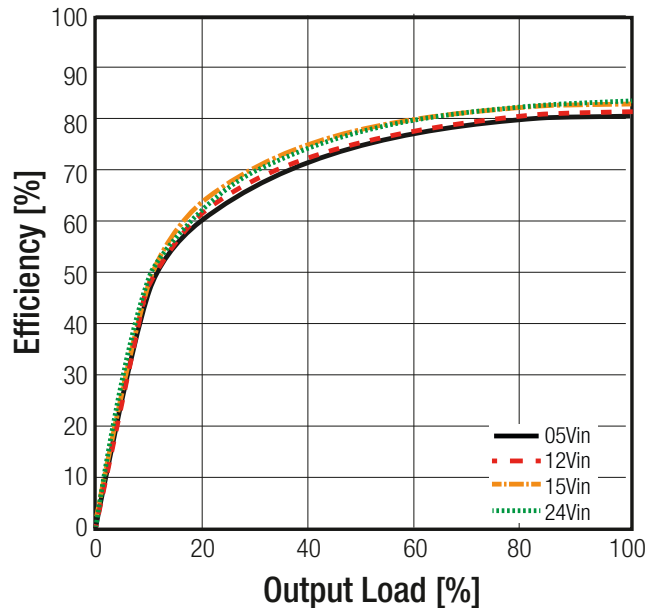

Specifications (measured @ Ta= 25°C, nominal input and full load after warm-up time unless otherwise noted)

REGULATIONS

Parameter	Condition	Values
Output Accuracy		±5.0% max.
Line Regulation	low line to high line, full load	1.2%/1% Vin typ.
Load Regulation	10% to 100% load	10.0% max.

Tolerance Envelope

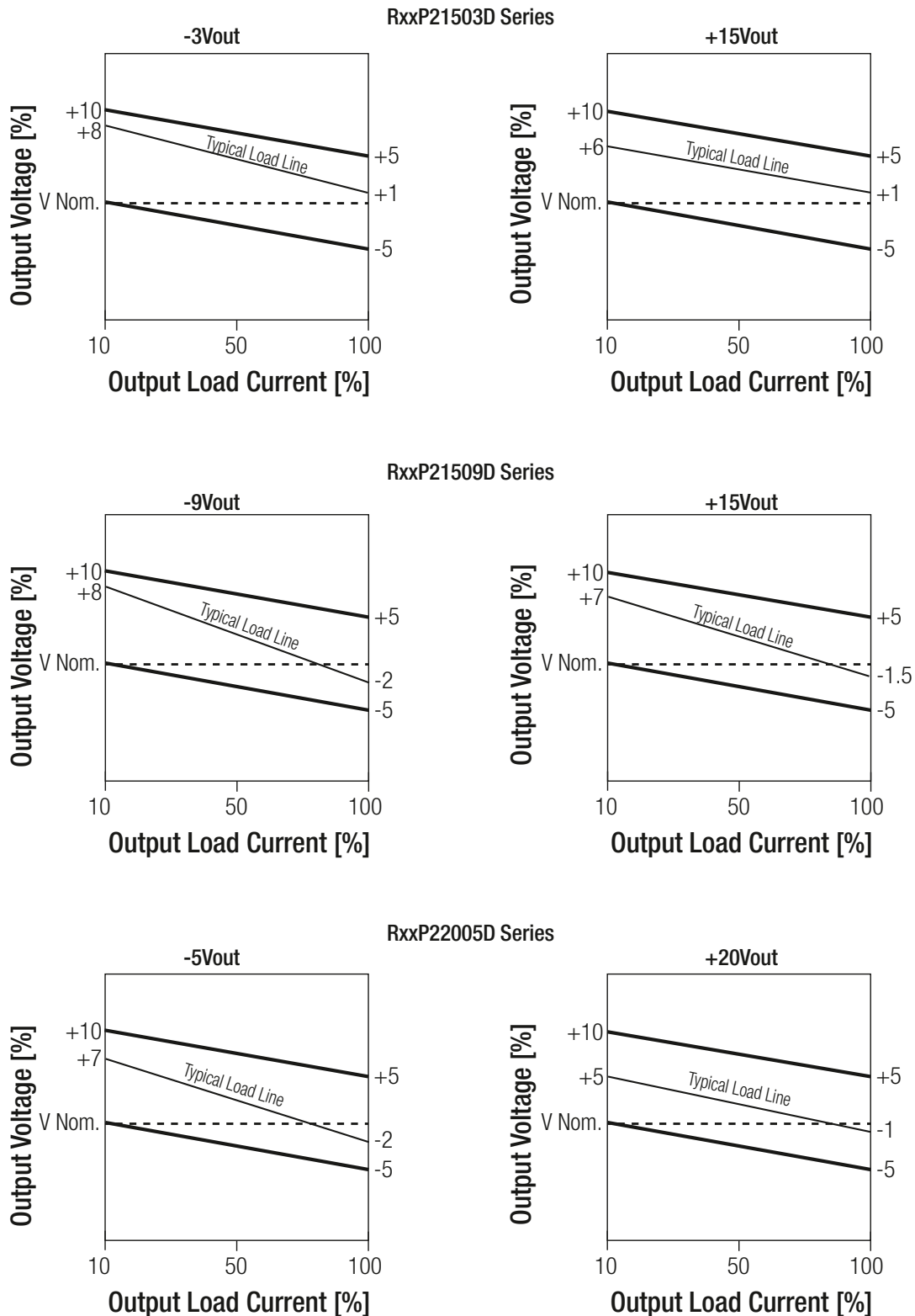

Specifications (measured @ Ta= 25°C, nominal Input and full load after warm-up time unless otherwise noted)

PROTECTIONS			
Parameter	Condition		Value
Short Circuit Protection	RxxP21509D RxxP22005D	only with suffix "/P"	continuous, automatic recovery
Isolation Voltage ⁽³⁾	I/P to O/P	tested for 1 second tested for 1 minute tested for 1 minute	6.4kVDC 5.2kVDC 3kVAC
Isolation Capacitance			3pF typ. / 10pF max.
Isolation Resistance			15GΩ min.
Insulation Grade			basic
Internal	clearance/creepage		2.0mm
External	clearance/creepage		7.0mm
Notes:			
Note3: For repeat Hi-Pot testing, reduce the time and/or the test voltage			
Note4: Refer to local safety regulations if input over-current protection is required. Recommended fuse: slow blow type			

ENVIRONMENTAL			
Parameter	Condition		Value
Operating Temperature Range	full load see derating graph below		-40°C to +90°C -40°C to +95°C
Maximum Case Temperature			+105°C max.
Temperature Coefficient			±0.02%/K
Thermal Impedance			30K/W
Operating Humidity	non-condensing		5-95% RH max.
Vibration			according to MIL-STD-202G
Pollution Degree			PD2
MTBF	according to MIL-HDBK-217F, G.B.	+25°C +90°C	14600 x 10 ³ hours 4000 x 10 ³ hours

Derating Graph

(@ Chamber and free air convection)

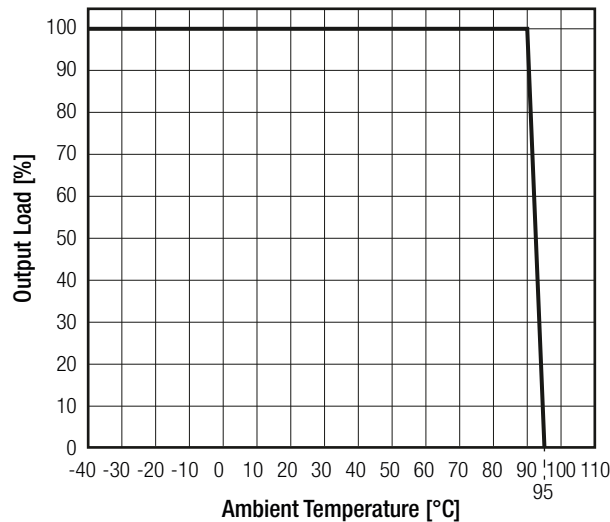

Specifications (measured @ Ta= 25°C, nominal input and full load after warm-up time unless otherwise noted)

SAFETY AND CERTIFICATIONS		
Certificate Type	Report / File Number	Standard
Information Technology Equipment, General Requirements for Safety	E224736-A56-UL	UL60950-1:2014, 2nd Edition CAN/CSA-C22.2 No. 60950-1-07:2014, 2nd Edition
Audio/Video, information and communication technology equipment - Part1: Safety requirements (CB Scheme)	ATTCB106076	IEC62368-1:2014, 2nd Edition
Audio/Video, information and communication technology equipment - Part1: Safety requirements		EN62368-1: 2014 + A11:2017
Audio/Video, information and communication technology equipment - Part1: Safety requirements	E224736-A56-UL	UL62368-1, 2nd Edition CAN/CSA-C22.2 No. 62368-1-14, 2014
EAC	RU-AT.49.09571	TP TC 004/2011
RoHs 2+		RoHS 10/10, 2011/65/EU + AM-2015/863

EMI Compliance	Condition	Standard / Criterion
Electromagnetic compatibility of multimedia equipment - Emission requirements	with external components (see filter suggestions)	EN55032, Class B

EMC Filtering according to EN55032 Class B

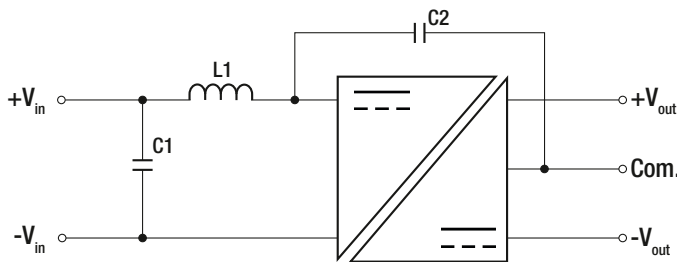

Component List Class B

Series	Vin	C1	L1	C2 ⁽³⁾
RxxP21503D	12VDC	2.2µF	47µH Choke	470pF 6kVDC
	15VDC			
	24VDC			
RxxP21509D	12VDC	10µF	10µH Choke	
	15VDC	4.7µF	22µH Choke	
	24VDC	2.2µF	47µH Choke	
RxxP22005D	5VDC	10µF	10µH Choke	
	12VDC	4.7µF	22µH Choke	
	15VDC			
	24VDC	2.2µF	47µH Choke	

Notes:

Note5: For SiC or IGBT application's, don't use C2 to decrease system isolation capacitance. Adapt primary filter according specific application

DIMENSION and PHYSICAL CHARACTERISTICS		
Parameter	Type	Value
Material	case	plastic, (UL94 V-0)
	potting	silicone, (UL94 V-0)
	PCB	FR4, (UL94 V-0)
Dimension (LxWxH)		19.5 x 9.8 x 12.5mm
Weight		4.3g typ.

continued on next page

Specifications (measured @ Ta= 25°C, nominal Input and full load after warm-up time unless otherwise noted)

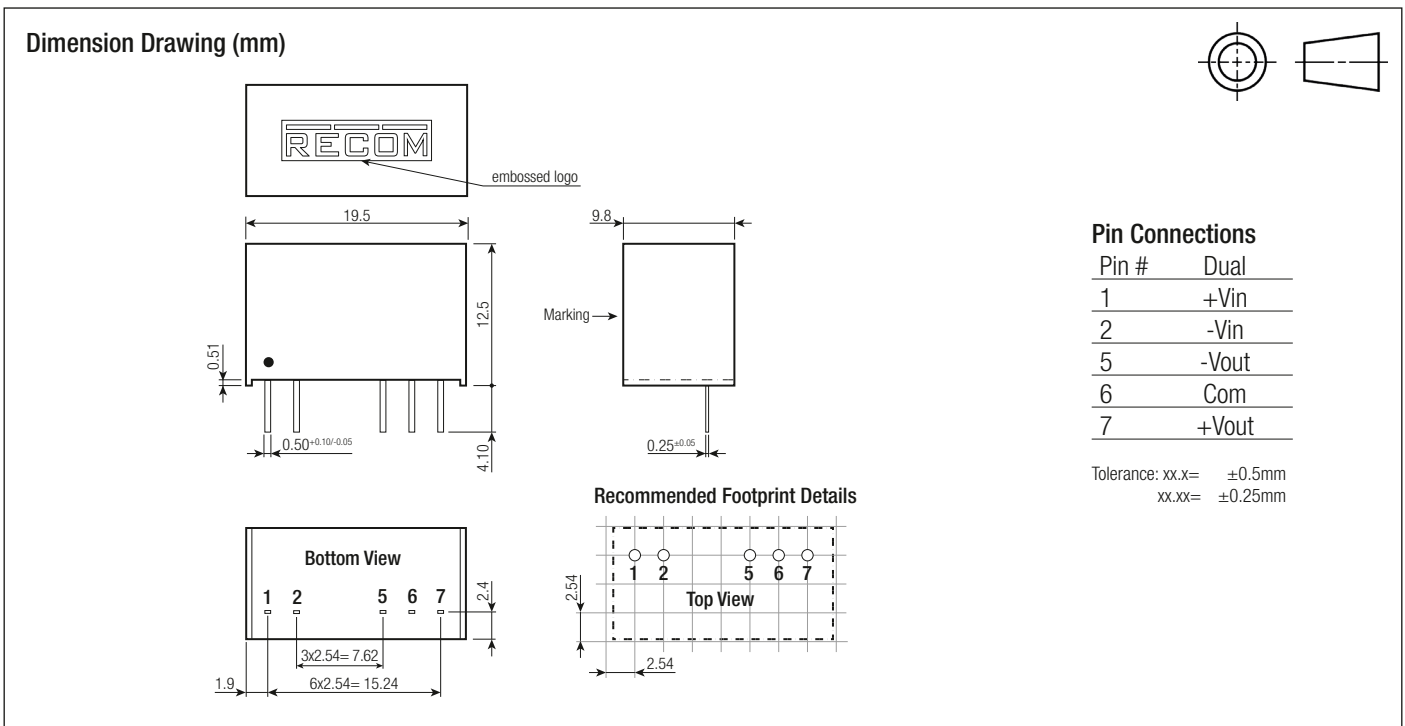

INSTALLATION AND APPLICATION

Typical Application Circuit

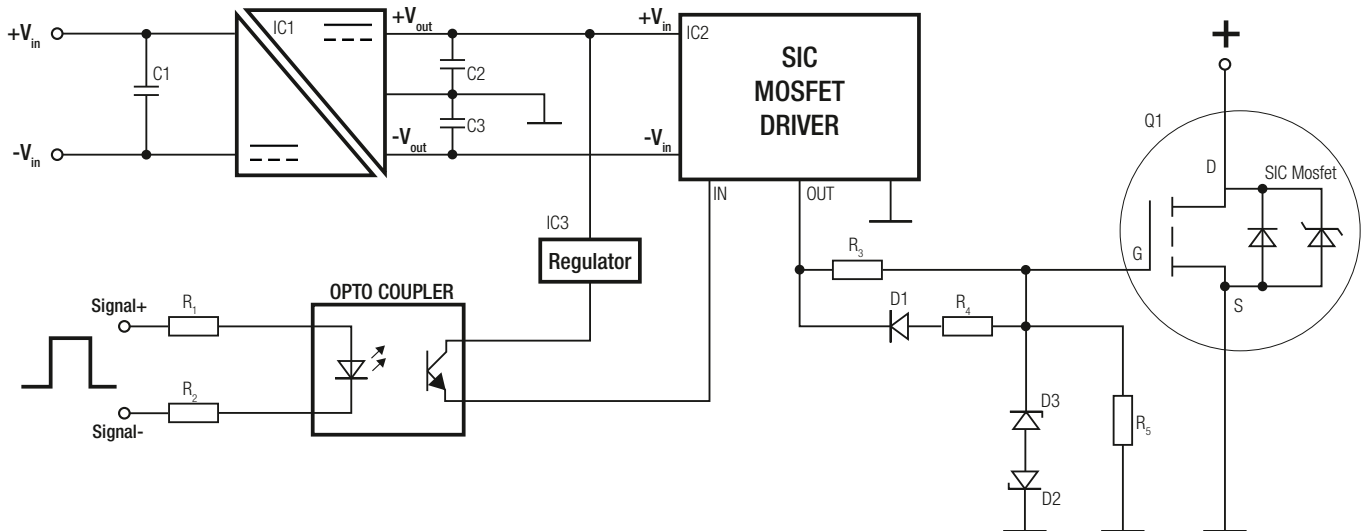

PACKAGING INFORMATION

Packaging Dimension (LxWxH)	tube	520.0 x 22.3 x 12.0mm
Packaging Quantity		25pcs
Storage Temperature Range		-55°C to +125°C
Storage Humidity		5-95% RH max.

The product information and specifications may be subject to changes even without prior written notice. The product has been designed for various applications; its suitability lies in the responsibility of each customer. The products are not authorized for use in safety-critical applications without RECOM's explicit written consent. A safety-critical application is an application where a failure may reasonably be expected to endanger or cause loss of life, inflict bodily harm or damage property. The applicant shall indemnify and hold harmless RECOM, its affiliated companies and its representatives against any damage claims in connection with the unauthorized use of RECOM products in such safety-critical applications.