

FEATURES

- Member of the Texas Instruments Widebus™ Family
- Operates From 1.65 V to 3.6 V
- Max t_{pd} of 3.6 ns at 3.3 V
- ± 24 -mA Output Drive at 3.3 V
- Bus Hold on Data Inputs Eliminates the Need for External Pullup/Pulldown Resistors
- Latch-Up Performance Exceeds 250 mA Per JESD 17
- ESD Protection Exceeds JESD 22
 - 2000-V Human-Body Model (A114-A)
 - 200-V Machine Model (A115-A)

DESCRIPTION/ORDERING INFORMATION

This 16-bit transparent D-type latch is designed for 1.65-V to 3.6-V V_{CC} operation.

The SN74ALVCH16373 is particularly suitable for implementing buffer registers, I/O ports, bidirectional bus drivers, and working registers. This device can be used as two 8-bit latches or one 16-bit latch. When the latch-enable (LE) input is high, the Q outputs follow the data (D) inputs. When LE is taken low, the Q outputs are latched at the levels set up at the D inputs.

A buffered output-enable (\overline{OE}) input can be used to place the eight outputs in either a normal logic state (high or low logic levels) or the high-impedance state. In the high-impedance state, the outputs neither load nor drive the buslines significantly. The high-impedance state and the increased drive provide the capability to drive bus lines without need for interface or pullup components. \overline{OE} does not affect internal operations of the latch. Old data can be retained or new data can be entered while the outputs are in the high-impedance state.

To ensure the high-impedance state during power up or power down, \overline{OE} should be tied to V_{CC} through a pullup resistor; the minimum value of the resistor is determined by the current-sinking capability of the driver.

Active bus-hold circuitry holds unused or undriven inputs at a valid logic state. Use of pullup or pulldown resistors with the bus-hold circuitry is not recommended.

DGG OR DL PACKAGE
(TOP VIEW)

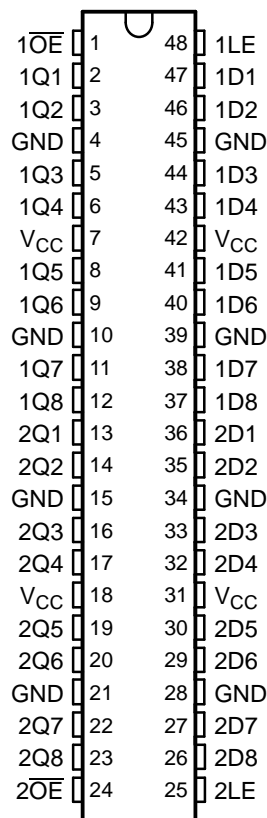

Please be aware that an important notice concerning availability, standard warranty, and use in critical applications of Texas Instruments semiconductor products and disclaimers thereto appears at the end of this data sheet.

Widebus is a trademark of Texas Instruments.

SN74ALVCH16373 16-BIT TRANSPARENT D-TYPE LATCH WITH 3-STATE OUTPUTS

SCES020I–JULY 1995–REVISED NOVEMBER 2005

ORDERING INFORMATION

| T _A | PACKAGE ⁽¹⁾ | | ORDERABLE PART NUMBER | TOP-SIDE MARKING |
|-----------------------|------------------------|---------------|-----------------------|------------------|
| –40°C to 85°C | FBGA – GRD | Tape and reel | SN74ALVCH16373GRDR | VH373 |
| | FBGA – ZRD (Pb-free) | | SN74ALVCH16373ZRDR | |
| | SSOP – DL | Tube | SN74ALVCH16373DL | ALVCH16373 |
| | | | Tape and reel | |
| | | Tape and reel | | |
| | | | 74ALVCH16373DLRG4 | |
| | TSSOP – DGG | Tape and reel | SN74ALVCH16373DGGR | ALVCH16373 |
| | | | 74ALVCH16373DGGE4 | |
| | | | 74ALVCH16373DGGRG4 | |
| | VFBGA – GQL | Tape and reel | SN74ALVCH16373KR | VH373 |
| VFBGA – ZQL (Pb-free) | 74ALVCH16373ZQLR | | | |

(1) Package drawings, standard packing quantities, thermal data, symbolization, and PCB design guidelines are available at www.ti.com/sc/package.

**GQL OR ZQL PACKAGE
(TOP VIEW)**

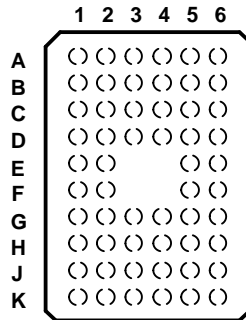

**TERMINAL ASSIGNMENTS⁽¹⁾
(56-Ball GQL/ZQL Package)**

| | 1 | 2 | 3 | 4 | 5 | 6 |
|----------|-------------------|-----|-----------------|-----------------|-----|-----|
| A | 1 \overline{OE} | NC | NC | NC | NC | 1LE |
| B | 1Q2 | 1Q1 | GND | GND | 1D1 | 1D2 |
| C | 1Q4 | 1Q3 | V _{CC} | V _{CC} | 1D3 | 1D4 |
| D | 1Q6 | 1Q5 | GND | GND | 1D5 | 1D6 |
| E | 1Q8 | 1Q7 | | | 1D7 | 1D8 |
| F | 2Q1 | 2Q2 | | | 2D2 | 2D1 |
| G | 2Q3 | 2Q4 | GND | GND | 2D4 | 2D3 |
| H | 2Q5 | 2Q6 | V _{CC} | V _{CC} | 2D6 | 2D5 |
| J | 2Q7 | 2Q8 | GND | GND | 2D8 | 2D7 |
| K | 2 \overline{OE} | NC | NC | NC | NC | 2LE |

(1) NC – No internal connection

**GRD OR ZRD PACKAGE
(TOP VIEW)**

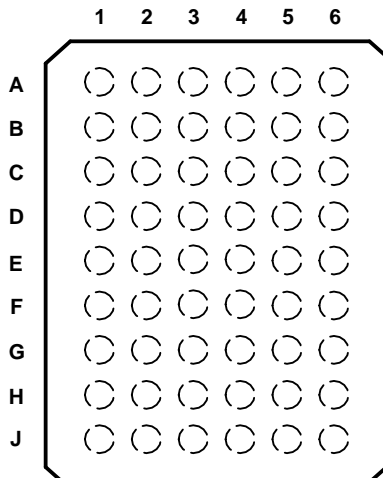

**TERMINAL ASSIGNMENTS⁽¹⁾
(54-Ball GRD/ZRD Package)**

| | 1 | 2 | 3 | 4 | 5 | 6 |
|----------|-----|-----|-------------------|-----------------|-----|-----|
| A | 1Q1 | NC | 1 \overline{OE} | 1LE | NC | 1D1 |
| B | 1Q3 | 1Q2 | NC | NC | 1D2 | 1D3 |
| C | 1Q5 | 1Q4 | V _{CC} | V _{CC} | 1D4 | 1D5 |
| D | 1Q7 | 1Q6 | GND | GND | 1D6 | 1D7 |
| E | 2Q1 | 1Q8 | GND | GND | 1D8 | 2D1 |
| F | 2Q3 | 2Q2 | GND | GND | 2D2 | 2D3 |
| G | 2Q5 | 2Q4 | V _{CC} | V _{CC} | 2D4 | 2D5 |
| H | 2Q7 | 2Q6 | NC | NC | 2D6 | 2D7 |
| J | 2Q8 | NC | 2 \overline{OE} | 2LE | NC | 2D8 |

(1) NC – No internal connection

**FUNCTION TABLE
(EACH 8-BIT SECTION)**

| INPUTS | | | OUTPUT Q |
|-----------------|----|---|-------------|
| \overline{OE} | LE | D | |
| L | H | H | H |
| L | H | L | L |
| L | L | X | Q_0 |
| H | X | X | Z |

LOGIC DIAGRAM (POSITIVE LOGIC)

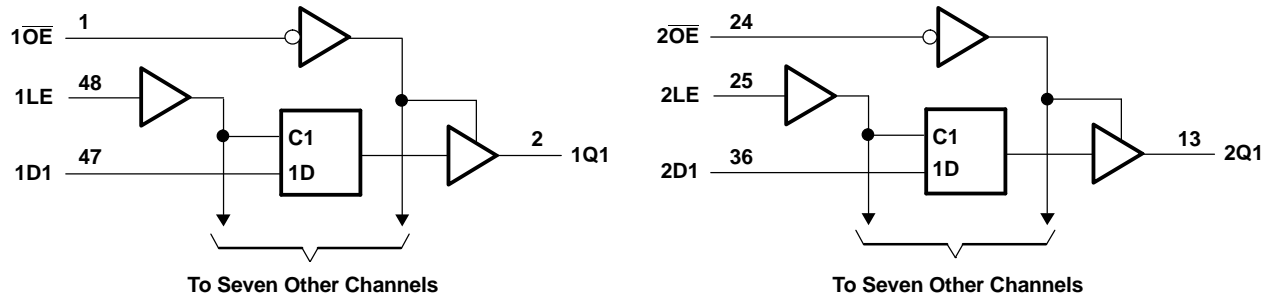

Pin numbers shown are for the DGG and DL packages.

Absolute Maximum Ratings⁽¹⁾

over operating free-air temperature range (unless otherwise noted)

| | | MIN | MAX | UNIT |
|---------------|---|-----------------|----------------|------|
| V_{CC} | Supply voltage range | -0.5 | 4.6 | V |
| V_I | Input voltage range ⁽²⁾⁽³⁾ | -0.5 | $V_{CC} + 0.5$ | V |
| V_O | Output voltage range ⁽²⁾⁽³⁾ | -0.5 | $V_{CC} + 0.5$ | V |
| I_{IK} | Input clamp current | | -50 | mA |
| I_{OK} | Output clamp current | | -50 | mA |
| I_O | Continuous output current | | ±50 | mA |
| | Continuous current through each V_{CC} or GND | | ±100 | mA |
| θ_{JA} | Package thermal impedance ⁽⁴⁾ | DGG package | 70 | °C/W |
| | | DL package | 63 | |
| | | GQL/ZQL package | 42 | |
| | | GRD/ZRD package | 36 | |
| T_{stg} | Storage temperature range | -65 | 150 | °C |

- (1) Stresses beyond those listed under "absolute maximum ratings" may cause permanent damage to the device. These are stress ratings only, and functional operation of the device at these or any other conditions beyond those indicated under "recommended operating conditions" is not implied. Exposure to absolute-maximum-rated conditions for extended periods may affect device reliability.
- (2) The input negative-voltage and output voltage ratings may be exceeded if the input and output current ratings are observed.
- (3) This value is limited to 4.6 V maximum.
- (4) The package thermal impedance is calculated in accordance with JESD 51-7.

SN74ALVCH16373
16-BIT TRANSPARENT D-TYPE LATCH
WITH 3-STATE OUTPUTS

SCES020I–JULY 1995–REVISED NOVEMBER 2005

Recommended Operating Conditions⁽¹⁾

| | | MIN | MAX | UNIT |
|-----------------|------------------------------------|------------------------------------|------------------------|------|
| V _{CC} | Supply voltage | 1.65 | 3.6 | V |
| V _{IH} | High-level input voltage | V _{CC} = 1.65 V to 1.95 V | 0.65 × V _{CC} | V |
| | | V _{CC} = 2.3 V to 2.7 V | 1.7 | |
| | | V _{CC} = 2.7 V to 3.6 V | 2 | |
| V _{IL} | Low-level input voltage | V _{CC} = 1.65 V to 1.95 V | 0.35 × V _{CC} | V |
| | | V _{CC} = 2.3 V to 2.7 V | 0.7 | |
| | | V _{CC} = 2.7 V to 3.6 V | 0.8 | |
| V _I | Input voltage | 0 | V _{CC} | V |
| V _O | Output voltage | 0 | V _{CC} | V |
| I _{OH} | High-level output current | V _{CC} = 1.65 V | –4 | mA |
| | | V _{CC} = 2.3 V | –12 | |
| | | V _{CC} = 2.7 V | –12 | |
| | | V _{CC} = 3 V | –24 | |
| I _{OL} | Low-level output current | V _{CC} = 1.65 V | 4 | mA |
| | | V _{CC} = 2.3 V | 12 | |
| | | V _{CC} = 2.7 V | 12 | |
| | | V _{CC} = 3 V | 24 | |
| Δt/Δv | Input transition rise or fall rate | | 10 | ns/V |
| T _A | Operating free-air temperature | –40 | 85 | °C |

(1) All unused control inputs of the device must be held at V_{CC} or GND to ensure proper device operation. Refer to the TI application report, *Implications of Slow or Floating CMOS Inputs*, literature number SCBA004.

Electrical Characteristics

over recommended operating free-air temperature range (unless otherwise noted)

| PARAMETER | | TEST CONDITIONS | V _{CC} | MIN | TYP ⁽¹⁾ | MAX | UNIT |
|----------------------|--------------------------|---|-----------------|-----------------------|--------------------|------|------|
| V _{OH} | | I _{OH} = -100 μA | 1.65 V to 3.6 V | V _{CC} - 0.2 | | | V |
| | | I _{OH} = -4 mA | 1.65 V | 1.2 | | | |
| | | I _{OH} = -6 mA | 2.3 V | 2 | | | |
| | | I _{OH} = -12 mA | 2.3 V | 1.7 | | | |
| | | | 2.7 V | 2.2 | | | |
| | | | 3 V | 2.4 | | | |
| | I _{OH} = -24 mA | 3 V | 2 | | | | |
| V _{OL} | | I _{OL} = 100 μA | 1.65 V to 3.6 V | | | 0.2 | V |
| | | I _{OL} = 4 mA | 1.65 V | | | 0.45 | |
| | | I _{OL} = 6 mA | 2.3 V | | | 0.4 | |
| | | I _{OL} = 12 mA | 2.3 V | | | 0.7 | |
| | | | 2.7 V | | | 0.4 | |
| | | I _{OL} = 24 mA | 3 V | | | 0.55 | |
| I _I | | V _I = V _{CC} or GND | 3.6 V | | | ±5 | μA |
| I _{I(hold)} | | V _I = 0.58 V | 1.65 V | 25 | | | μA |
| | | V _I = 1.07 V | 1.65 V | -25 | | | |
| | | V _I = 0.7 V | 2.3 V | 45 | | | |
| | | V _I = 1.7 V | 2.3 V | -45 | | | |
| | | V _I = 0.8 V | 3 V | 75 | | | |
| | | V _I = 2 V | 3 V | -75 | | | |
| | | V _I = 0 to 3.6 V ⁽²⁾ | 3.6 V | | | ±500 | |
| I _{OZ} | | V _O = V _{CC} or GND | 3.6 V | | | ±10 | μA |
| I _{CC} | | V _I = V _{CC} or GND I _O = 0 | 3.6 V | | | 40 | μA |
| ΔI _{CC} | | One input at V _{CC} - 0.6 V, Other inputs at V _{CC} or GND | 3 V to 3.6 V | | | 750 | μA |
| C _i | Control inputs | V _I = V _{CC} or GND | 3.3 V | | | 3 | pF |
| | Data inputs | | | | | 6 | |
| C _o | Outputs | V _O = V _{CC} or GND | 3.3 V | | | 7 | pF |

(1) All typical values are at V_{CC} = 3.3 V, T_A = 25°C.

(2) This is the bus-hold maximum dynamic current. It is the minimum overdrive current required to switch the input from one state to another.

Timing Requirements

over recommended operating free-air temperature range (unless otherwise noted) (see Figure 1)

| | | V _{CC} = 1.8 V | | V _{CC} = 2.5 V ± 0.2 V | | V _{CC} = 2.7 V | | V _{CC} = 3.3 V ± 0.3 V | | UNIT |
|-----------------|--------------------------------|-------------------------|-----|------------------------------------|-----|-------------------------|-----|------------------------------------|-----|------|
| | | MIN | MAX | MIN | MAX | MIN | MAX | MIN | MAX | |
| t _w | Pulse duration, LE high or low | (1) | | 3.3 | | 3.3 | | 3.3 | | ns |
| t _{su} | Setup time, data before LE↓ | (1) | | 1 | | 1 | | 1.1 | | ns |
| t _h | Hold time, data after LE↓ | (1) | | 1.5 | | 1.7 | | 1.4 | | ns |

(1) This information was not available at the time of publication.

SN74ALVCH16373
16-BIT TRANSPARENT D-TYPE LATCH
WITH 3-STATE OUTPUTS

SCES020I–JULY 1995–REVISED NOVEMBER 2005

Switching Characteristics

over recommended operating free-air temperature range (unless otherwise noted) (see Figure 1)

| PARAMETER | FROM (INPUT) | TO (OUTPUT) | V _{CC} = 1.8 V | V _{CC} = 2.5 V ± 0.2 V | | V _{CC} = 2.7 V | | V _{CC} = 3.3 V ± 0.3 V | | UNIT |
|------------------|-----------------|-------------|-------------------------|---------------------------------|-----|-------------------------|-----|---------------------------------|-----|------|
| | | | TYP | MIN | MAX | MIN | MAX | MIN | MAX | |
| t _{pd} | D | Q | (1) | 1 | 4.5 | 4.3 | | 1.1 | 3.6 | ns |
| | LE | | (1) | 1 | 4.9 | 4.6 | | 1 | 3.9 | |
| t _{en} | \overline{OE} | Q | (1) | 1 | 6 | 5.7 | | 1 | 4.7 | ns |
| t _{dis} | \overline{OE} | Q | (1) | 1.2 | 5.1 | 4.5 | | 1.4 | 4.1 | ns |

(1) This information was not available at the time of publication.

Operating Characteristics

T_A = 25°C

| PARAMETER | | TEST CONDITIONS | V _{CC} = 1.8 V | V _{CC} = 2.5 V | V _{CC} = 3.3 V | UNIT |
|-----------------|-------------------------------|------------------------------------|-------------------------|-------------------------|-------------------------|------|
| | | | TYP | TYP | TYP | |
| C _{pd} | Power dissipation capacitance | C _L = 50 pF, f = 10 MHz | (1) | 19 | 22 | pF |
| | Outputs disabled | | (1) | 4 | 5 | |

(1) This information was not available at the time of publication.

PARAMETER MEASUREMENT INFORMATION

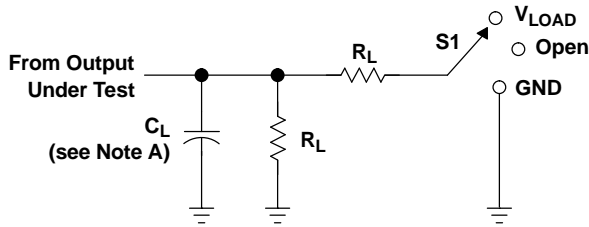

| TEST | S1 |
|-------------------|------------|
| t_{pd} | Open |
| t_{PLZ}/t_{PZL} | V_{LOAD} |
| t_{PHZ}/t_{PZH} | GND |

LOAD CIRCUIT

| V_{CC} | INPUT | | V_M | V_{LOAD} | C_L | R_L | V_{Δ} |
|-------------------|----------|---------------|------------|-------------------|-------|--------------|--------------|
| | V_I | t_r/t_f | | | | | |
| 1.8 V | V_{CC} | ≤ 2 ns | $V_{CC}/2$ | $2 \times V_{CC}$ | 30 pF | 1 k Ω | 0.15 V |
| $2.5 V \pm 0.2 V$ | V_{CC} | ≤ 2 ns | $V_{CC}/2$ | $2 \times V_{CC}$ | 30 pF | 500 Ω | 0.15 V |
| 2.7 V | 2.7 V | ≤ 2.5 ns | 1.5 V | 6 V | 50 pF | 500 Ω | 0.3 V |
| $3.3 V \pm 0.3 V$ | 2.7 V | ≤ 2.5 ns | 1.5 V | 6 V | 50 pF | 500 Ω | 0.3 V |

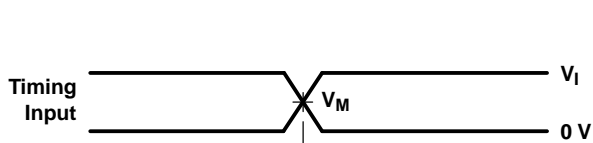

VOLTAGE WAVEFORMS
SETUP AND HOLD TIMES

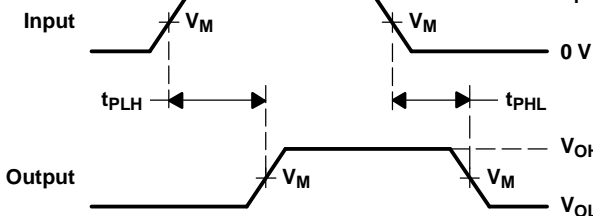

VOLTAGE WAVEFORMS
PROPAGATION DELAY TIMES

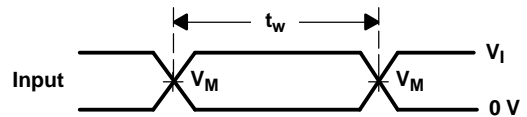

VOLTAGE WAVEFORMS
PULSE DURATION

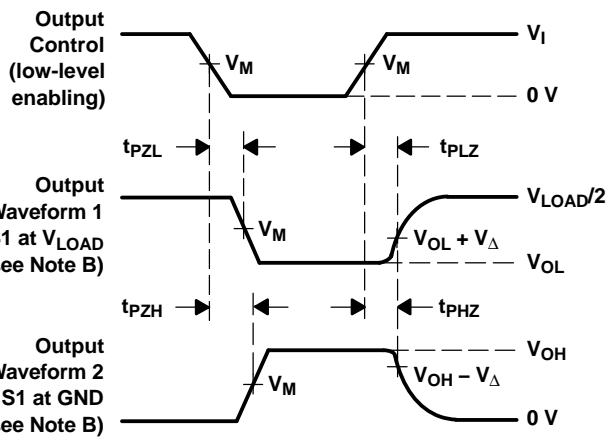

VOLTAGE WAVEFORMS
ENABLE AND DISABLE TIMES

- NOTES: A. C_L includes probe and jig capacitance.
 B. Waveform 1 is for an output with internal conditions such that the output is low, except when disabled by the output control. Waveform 2 is for an output with internal conditions such that the output is high, except when disabled by the output control.
 C. All input pulses are supplied by generators having the following characteristics: $PRR \leq 10$ MHz, $Z_O = 50 \Omega$.
 D. The outputs are measured one at a time, with one transition per measurement.
 E. t_{PLZ} and t_{PHZ} are the same as t_{dis} .
 F. t_{PZL} and t_{PZH} are the same as t_{en} .
 G. t_{PLH} and t_{PHL} are the same as t_{pd} .
 H. All parameters and waveforms are not applicable to all devices.

Figure 1. Load Circuit and Voltage Waveforms

PACKAGING INFORMATION

| Orderable Device | Status (1) | Package Type | Package Drawing | Pins | Package Qty | Eco Plan (2) | Lead finish/ Ball material (6) | MSL Peak Temp (3) | Op Temp (°C) | Device Marking (4/5) | Samples |
|--------------------|---------------|--------------|-----------------|------|-------------|-----------------|--------------------------------------|----------------------|--------------|-------------------------|-------------------------|
| 74ALVCH16373DGGRG4 | ACTIVE | TSSOP | DGG | 48 | 2000 | RoHS & Green | NIPDAU | Level-1-260C-UNLIM | -40 to 85 | ALVCH16373 | Samples |
| SN74ALVCH16373DGGR | ACTIVE | TSSOP | DGG | 48 | 2000 | RoHS & Green | NIPDAU | Level-1-260C-UNLIM | -40 to 85 | ALVCH16373 | Samples |
| SN74ALVCH16373DL | ACTIVE | SSOP | DL | 48 | 25 | RoHS & Green | NIPDAU | Level-1-260C-UNLIM | -40 to 85 | ALVCH16373 | Samples |
| SN74ALVCH16373DLR | ACTIVE | SSOP | DL | 48 | 1000 | RoHS & Green | NIPDAU | Level-1-260C-UNLIM | -40 to 85 | ALVCH16373 | Samples |

(1) The marketing status values are defined as follows:

ACTIVE: Product device recommended for new designs.

LIFEBUY: TI has announced that the device will be discontinued, and a lifetime-buy period is in effect.

NRND: Not recommended for new designs. Device is in production to support existing customers, but TI does not recommend using this part in a new design.

PREVIEW: Device has been announced but is not in production. Samples may or may not be available.

OBSELETE: TI has discontinued the production of the device.

(2) **RoHS:** TI defines "RoHS" to mean semiconductor products that are compliant with the current EU RoHS requirements for all 10 RoHS substances, including the requirement that RoHS substance do not exceed 0.1% by weight in homogeneous materials. Where designed to be soldered at high temperatures, "RoHS" products are suitable for use in specified lead-free processes. TI may reference these types of products as "Pb-Free".

RoHS Exempt: TI defines "RoHS Exempt" to mean products that contain lead but are compliant with EU RoHS pursuant to a specific EU RoHS exemption.

Green: TI defines "Green" to mean the content of Chlorine (Cl) and Bromine (Br) based flame retardants meet JS709B low halogen requirements of <=1000ppm threshold. Antimony trioxide based flame retardants must also meet the <=1000ppm threshold requirement.

(3) **MSL, Peak Temp.** - The Moisture Sensitivity Level rating according to the JEDEC industry standard classifications, and peak solder temperature.

(4) There may be additional marking, which relates to the logo, the lot trace code information, or the environmental category on the device.

(5) Multiple Device Markings will be inside parentheses. Only one Device Marking contained in parentheses and separated by a "-" will appear on a device. If a line is indented then it is a continuation of the previous line and the two combined represent the entire Device Marking for that device.

(6) **Lead finish/Ball material** - Orderable Devices may have multiple material finish options. Finish options are separated by a vertical ruled line. Lead finish/Ball material values may wrap to two lines if the finish value exceeds the maximum column width.

Important Information and Disclaimer: The information provided on this page represents TI's knowledge and belief as of the date that it is provided. TI bases its knowledge and belief on information provided by third parties, and makes no representation or warranty as to the accuracy of such information. Efforts are underway to better integrate information from third parties. TI has taken and

continues to take reasonable steps to provide representative and accurate information but may not have conducted destructive testing or chemical analysis on incoming materials and chemicals. TI and TI suppliers consider certain information to be proprietary, and thus CAS numbers and other limited information may not be available for release.

In no event shall TI's liability arising out of such information exceed the total purchase price of the TI part(s) at issue in this document sold by TI to Customer on an annual basis.

TAPE AND REEL INFORMATION



QUADRANT ASSIGNMENTS FOR PIN 1 ORIENTATION IN TAPE



*All dimensions are nominal

| Device | Package Type | Package Drawing | Pins | SPQ | Reel Diameter (mm) | Reel Width W1 (mm) | A0 (mm) | B0 (mm) | K0 (mm) | P1 (mm) | W (mm) | Pin1 Quadrant |
|--------------------|--------------|-----------------|------|------|--------------------|--------------------|---------|---------|---------|---------|--------|---------------|
| SN74ALVCH16373DGGR | TSSOP | DGG | 48 | 2000 | 330.0 | 24.4 | 8.6 | 13.0 | 1.8 | 12.0 | 24.0 | Q1 |
| SN74ALVCH16373DLR | SSOP | DL | 48 | 1000 | 330.0 | 32.4 | 11.35 | 16.2 | 3.1 | 16.0 | 32.0 | Q1 |

TAPE AND REEL BOX DIMENSIONS

*All dimensions are nominal

| Device | Package Type | Package Drawing | Pins | SPQ | Length (mm) | Width (mm) | Height (mm) |
|--------------------|--------------|-----------------|------|------|-------------|------------|-------------|
| SN74ALVCH16373DGGR | TSSOP | DGG | 48 | 2000 | 367.0 | 367.0 | 45.0 |
| SN74ALVCH16373DLR | SSOP | DL | 48 | 1000 | 367.0 | 367.0 | 55.0 |

MECHANICAL DATA

DL (R-PDSO-G48)

PLASTIC SMALL-OUTLINE PACKAGE



- NOTES:
- All linear dimensions are in inches (millimeters).
 - This drawing is subject to change without notice.
 - Body dimensions do not include mold flash or protrusion not to exceed 0.006 (0,15).
 - Falls within JEDEC MO-118

PowerPAD is a trademark of Texas Instruments.



4214859/B 11/2020

NOTES:

- All linear dimensions are in millimeters. Any dimensions in parenthesis are for reference only. Dimensioning and tolerancing per ASME Y14.5M.
- This drawing is subject to change without notice.
- This dimension does not include mold flash, protrusions, or gate burrs. Mold flash, protrusions, or gate burrs shall not exceed 0.15 mm per side.
- Reference JEDEC registration MO-153.

EXAMPLE BOARD LAYOUT

DGG0048A

TSSOP - 1.2 mm max height

SMALL OUTLINE PACKAGE



LAND PATTERN EXAMPLE
SCALE:6X



SOLDER MASK DETAILS

4214859/B 11/2020

NOTES: (continued)

5. Publication IPC-7351 may have alternate designs.
6. Solder mask tolerances between and around signal pads can vary based on board fabrication site.

EXAMPLE STENCIL DESIGN

DGG0048A

TSSOP - 1.2 mm max height

SMALL OUTLINE PACKAGE



SOLDER PASTE EXAMPLE
BASED ON 0.125 mm THICK STENCIL
SCALE:6X

4214859/B 11/2020

NOTES: (continued)

7. Laser cutting apertures with trapezoidal walls and rounded corners may offer better paste release. IPC-7525 may have alternate design recommendations.
8. Board assembly site may have different recommendations for stencil design.

DGG (R-PDSO-G**)

PLASTIC SMALL-OUTLINE PACKAGE

48 PINS SHOWN



- NOTES: A. All linear dimensions are in millimeters.
 B. This drawing is subject to change without notice.
 C. Body dimensions do not include mold protrusion not to exceed 0,15.
 D. Falls within JEDEC MO-153

IMPORTANT NOTICE AND DISCLAIMER

TI PROVIDES TECHNICAL AND RELIABILITY DATA (INCLUDING DATASHEETS), DESIGN RESOURCES (INCLUDING REFERENCE DESIGNS), APPLICATION OR OTHER DESIGN ADVICE, WEB TOOLS, SAFETY INFORMATION, AND OTHER RESOURCES "AS IS" AND WITH ALL FAULTS, AND DISCLAIMS ALL WARRANTIES, EXPRESS AND IMPLIED, INCLUDING WITHOUT LIMITATION ANY IMPLIED WARRANTIES OF MERCHANTABILITY, FITNESS FOR A PARTICULAR PURPOSE OR NON-INFRINGEMENT OF THIRD PARTY INTELLECTUAL PROPERTY RIGHTS.

These resources are intended for skilled developers designing with TI products. You are solely responsible for (1) selecting the appropriate TI products for your application, (2) designing, validating and testing your application, and (3) ensuring your application meets applicable standards, and any other safety, security, or other requirements. These resources are subject to change without notice. TI grants you permission to use these resources only for development of an application that uses the TI products described in the resource. Other reproduction and display of these resources is prohibited. No license is granted to any other TI intellectual property right or to any third party intellectual property right. TI disclaims responsibility for, and you will fully indemnify TI and its representatives against, any claims, damages, costs, losses, and liabilities arising out of your use of these resources.

TI's products are provided subject to TI's Terms of Sale (<https://www.ti.com/legal/termsofsale.html>) or other applicable terms available either on [ti.com](https://www.ti.com) or provided in conjunction with such TI products. TI's provision of these resources does not expand or otherwise alter TI's applicable warranties or warranty disclaimers for TI products.

Mailing Address: Texas Instruments, Post Office Box 655303, Dallas, Texas 75265
Copyright © 2021, Texas Instruments Incorporated