

# ADA4077-1/ADA4077-2/ADA4077-4

4 MHz, 7 nV/ $\sqrt{\text{Hz}}$ , Low Offset and Drift, High Precision Amplifiers

## FEATURES

- ▶ Offset voltage:
  - ▶ 25  $\mu\text{V}$  maximum at 25°C (B grade, 8-lead SOIC, single/ dual)
  - ▶ 50  $\mu\text{V}$  maximum at 25°C (A grade, 8-lead SOIC, single/ dual)
  - ▶ 50  $\mu\text{V}$  maximum at 25°C (A grade, 14-lead SOIC, quad)
- ▶ Offset voltage drift:
  - ▶ 0.25  $\mu\text{V}/^\circ\text{C}$  maximum (B grade, 8-lead SOIC, single/dual)
  - ▶ 0.55  $\mu\text{V}/^\circ\text{C}$  maximum (A grade, 8-lead SOIC, single/dual)
  - ▶ 0.75  $\mu\text{V}/^\circ\text{C}$  maximum (A grade, 14-lead SOIC, quad)
- ▶ MSL1 rated
- ▶ Low input bias current: 1 nA maximum at  $T_A = 25^\circ\text{C}$
- ▶ Low voltage noise density: 6.9 nV/ $\sqrt{\text{Hz}}$  typical at  $f = 1000 \text{ Hz}$
- ▶ CMRR, PSRR, and  $A_V > 120 \text{ dB}$  minimum
- ▶ Low supply current: 400  $\mu\text{A}$  per amplifier typical
- ▶ Wide gain bandwidth product: 3.9 MHz at  $\pm 5 \text{ V}$
- ▶ Dual-supply operation:
  - ▶ Specified at  $\pm 5 \text{ V}$  to  $\pm 15 \text{ V}$
  - ▶ Operates at  $\pm 2.5 \text{ V}$  to  $\pm 15 \text{ V}$
- ▶ Unity gain stable
- ▶ No phase reversal
- ▶ Long-term offset voltage drift (10,000 hours): 0.5  $\mu\text{V}$  typical
- ▶ Temperature hysteresis: 1  $\mu\text{V}$  typical

## APPLICATIONS

- ▶ Process control front-end amplifiers
- ▶ Optical network control circuits
- ▶ Instrumentation
- ▶ Precision sensors and controls
- ▶ Precision filters

## GENERAL DESCRIPTION

The single ADA4077-1, dual ADA4077-2, and quad ADA4077-4 amplifiers feature extremely low offset voltage and drift, and low input bias current, noise, and power consumption. Outputs are stable with capacitive loads of more than 1000 pF with no external compensation.

Applications for this amplifier include sensor signal conditioning (such as thermocouples, resistance temperature detectors (RTDs), strain gages), process control front-end amplifiers, and precision diode power measurement in optical and wireless transmission systems. The ADA4077-1/ADA4077-2/ADA4077-4 are useful in line powered and portable instrumentation, precision filters, and voltage or current measurement and level setting.

## PIN CONNECTION DIAGRAMS

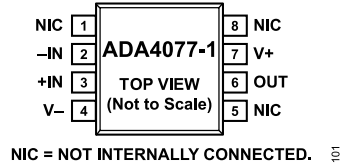

Figure 1. ADA4077-1, 8-Lead SOIC and 8-Lead MSOP

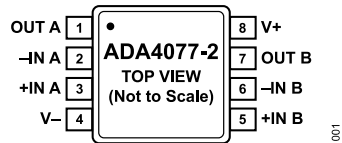

Figure 2. ADA4077-2, 8-Lead MSOP and 8-Lead SOIC

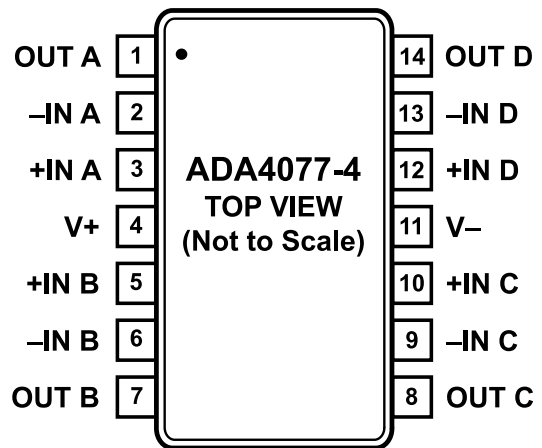

Figure 3. ADA4077-4, 14-Lead TSSOP and 14-Lead SOIC

Unlike other amplifiers, the ADA4077-1/ADA4077-2/ADA4077-4 have an MSL1 rating that is compliant with the most stringent of assembly processes, and they are specified over the extended industrial temperature range from  $-40^\circ\text{C}$  to  $+125^\circ\text{C}$  for the most demanding operating environments.

Table 1. Evolution of Precision Devices by Generation

| Op Amp | First | Second | Third | Fourth | Fifth  | Sixth     |
|--------|-------|--------|-------|--------|--------|-----------|
| Single | OP07  | OP77   | OP177 | OP1177 | AD8677 | ADA4077-1 |
| Dual   |       |        |       | OP2177 |        | ADA4077-2 |
| Quad   |       |        |       | OP4177 |        | ADA4077-4 |

**TABLE OF CONTENTS**

|   |   |  |    |
|---|---|--|----|
| Features.....                                     | 1 | Typical Performance Characteristics..... | 10 |
| Applications.....                                 | 1 | Test Circuit.....                        | 20 |
| Pin Connection Diagrams.....                      | 1 | Theory of Operation.....                 | 21 |
| General Description.....                          | 1 | Applications Information.....            | 22 |
| Specifications.....                               | 3 | Output Phase Reversal.....               | 22 |
| Electrical Characteristics, $\pm 5$ V.....        | 3 | Low Power Linearized RTD.....            | 22 |
| Electrical Characteristics, $\pm 15$ V.....       | 4 | Proper Board Layout.....                 | 22 |
| Absolute Maximum Ratings.....                     | 6 | Long-Term Drift.....                     | 22 |
| Thermal Resistance.....                           | 6 | Temperature Hysteresis.....              | 23 |
| ESD Caution.....                                  | 6 | Outline Dimensions.....                  | 24 |
| Pin Configurations and Function Descriptions..... | 7 | Ordering Guide.....                      | 25 |

**REVISION HISTORY****8/2022—Rev. E to Rev. F**

|   |    |
|---|----|
| Changes to General Description Section.....   | 1  |
| Deleted Figure 4, Renumbered Sequentially.....  | 1  |
| Changes to Output Voltage High Parameter and Output Voltage Low Parameter, Table 2..... | 3  |
| Changes to Output Voltage High Parameter and Output Voltage Low Parameter, Table 3..... | 4  |
| Changes to Typical Performance Characteristics Section.....                             | 10 |

## SPECIFICATIONS

ELECTRICAL CHARACTERISTICS,  $\pm 5$  V

$V_{SY} = \pm 5.0$  V,  $V_{CM} = 0$  V,  $T_A = 25^\circ\text{C}$ , unless otherwise noted.

Table 2.

| Parameter                           | Symbol                   | Test Conditions/Comments  | Min  | Typ      | Max  | Unit                         |
|-------------------------------------|--------------------------|---|------|----------|------|------------------------------|
| INPUT CHARACTERISTICS               |                          |   |      |          |      |                              |
| Offset Voltage                      | $V_{OS}$                 |   |      |          |      |                              |
| <a href="#">ADA4077-1/ADA4077-2</a> |                          |   |      |          |      |                              |
| B Grade, SOIC                       |                          | $-40^\circ\text{C} < T_A < +125^\circ\text{C}$                            |      | 10       | 25   | $\mu\text{V}$                |
| A Grade, SOIC                       |                          | $-40^\circ\text{C} < T_A < +125^\circ\text{C}$                            |      | 15       | 50   | $\mu\text{V}$                |
| A Grade, MSOP                       |                          | $-40^\circ\text{C} < T_A < +125^\circ\text{C}$                            |      | 50       | 90   | $\mu\text{V}$                |
| <a href="#">ADA4077-4</a>           |                          |   |      |          |      |                              |
| A Grade, SOIC                       |                          | $-40^\circ\text{C} < T_A < +125^\circ\text{C}$                            |      | 15       | 50   | $\mu\text{V}$                |
| A Grade, TSSOP                      |                          | $-40^\circ\text{C} < T_A < +125^\circ\text{C}$                            |      | 15       | 105  | $\mu\text{V}$                |
| Offset Voltage Drift                | $\Delta V_{OS}/\Delta T$ | $-40^\circ\text{C} < T_A < +125^\circ\text{C}$                            |      |          | 220  | $\mu\text{V}/^\circ\text{C}$ |
| <a href="#">ADA4077-1/ADA4077-2</a> |                          |   |      |          |      |                              |
| B Grade, SOIC                       |                          |   |      | 0.1      | 0.25 | $\mu\text{V}/^\circ\text{C}$ |
| A Grade, SOIC                       |                          |   |      | 0.25     | 0.55 | $\mu\text{V}/^\circ\text{C}$ |
| A Grade, MSOP                       |                          |   |      | 0.5      | 1.2  | $\mu\text{V}/^\circ\text{C}$ |
| <a href="#">ADA4077-4</a>           |                          |   |      |          |      |                              |
| A Grade, SOIC                       |                          |   |      | 0.4      | 0.75 | $\mu\text{V}/^\circ\text{C}$ |
| A Grade, TSSOP                      |                          |   |      | 0.5      | 1.2  | $\mu\text{V}/^\circ\text{C}$ |
| Input Bias Current                  | $I_B$                    | $-40^\circ\text{C} < T_A < +125^\circ\text{C}$                            | -1   | -0.4     | +1   | nA                           |
| Input Offset Current                | $I_{OS}$                 | $-40^\circ\text{C} < T_A < +125^\circ\text{C}$                            | -1.5 | +0.1     | +1.5 | nA                           |
| Input Voltage Range                 |                          |   | -3.8 |          | +3   | V                            |
| Common-Mode Rejection Ratio         | CMRR                     | $V_{CM} = -3.8$ V to +3 V   | 122  | 140      |      | dB                           |
|                                     |                          | $V_{CM} = -3.8$ V to +3 V, $-40^\circ\text{C} < T_A < +85^\circ\text{C}$  | 120  |          |      | dB                           |
|                                     |                          | $V_{CM} = -3.8$ V to +2.8 V, $85^\circ\text{C} < T_A < 125^\circ\text{C}$ | 120  |          |      | dB                           |
| Large Signal Voltage Gain           | $A_V$                    | $R_L = 2$ k $\Omega$ , $V_O = -3.0$ V to +3.0 V                           | 121  | 130      |      | dB                           |
|                                     |                          | $-40^\circ\text{C} < T_A < +125^\circ\text{C}$                            | 120  |          |      | dB                           |
| Input Capacitance                   | $C_{INCM}$               | Common mode   |      | 5        |      | pF                           |
| Input Resistance                    | $R_{IN}$                 | Common mode   |      | 70       |      | G $\Omega$                   |
| OUTPUT CHARACTERISTICS              |                          |   |      |          |      |                              |
| Output Voltage High                 | $V_{OH}$                 | $I_L = 1$ mA  | 3.5  |          |      | V                            |
|                                     |                          | $-40^\circ\text{C} < T_A < +125^\circ\text{C}$                            | 3.2  |          |      | V                            |
| Output Voltage Low                  | $V_{OL}$                 | $I_L = 1$ mA  |      |          | -3.5 | V                            |
|                                     |                          | $-40^\circ\text{C} < T_A < +125^\circ\text{C}$                            |      |          | -3.2 | V                            |
| Output Current                      | $I_{OUT}$                | $V_{DROPOUT} < 1.6$ V   |      | $\pm 10$ |      | mA                           |
| Short-Circuit Current               | $I_{SC}$                 | $T_A = 25^\circ\text{C}$  |      | 22       |      | mA                           |
| Closed-Loop Output Impedance        | $Z_{OUT}$                | $f = 1$ kHz, $A_V = +1$   |      | 0.05     |      | $\Omega$                     |
| POWER SUPPLY                        |                          |   |      |          |      |                              |
| Power Supply Rejection Ratio        | PSRR                     | $V_S = \pm 2.5$ V to $\pm 18$ V   | 123  | 128      |      | dB                           |
|                                     |                          | $-40^\circ\text{C} < T_A < +125^\circ\text{C}$                            | 120  |          |      | dB                           |

## SPECIFICATIONS

Table 2.

| Parameter                              | Symbol    | Test Conditions/Comments  | Min | Typ   | Max        | Unit                           |
|--|-----------|---|-----|-------|------------|--------------------------------|
| Supply Current per Amplifier           | $I_{SY}$  | $V_O = 0\text{ V}$<br>$-40^\circ\text{C} < T_A < +125^\circ\text{C}$          |     | 400   | 450<br>650 | $\mu\text{A}$<br>$\mu\text{A}$ |
| <b>DYNAMIC PERFORMANCE</b>             |           |   |     |       |            |                                |
| Slew Rate                              | SR        | $R_L = 2\text{ k}\Omega$  |     | 1.2   |            | $\text{V}/\mu\text{s}$         |
| Settling Time to 0.1%                  | $t_S$     | $V_{IN} = 1\text{ V step}, R_L = 2\text{ k}\Omega, A_V = -1$                  |     | 3     |            | $\mu\text{s}$                  |
| Gain Bandwidth Product                 | GBP       | $V_{IN} = 10\text{ mV p-p}, R_L = 2\text{ k}\Omega, A_V = +100$               |     | 3.9   |            | MHz                            |
| Unity-Gain Crossover                   | UGC       | $V_{IN} = 10\text{ mV p-p}, R_L = 2\text{ k}\Omega, A_V = +1$                 |     | 3.9   |            | MHz                            |
| -3 dB Closed-Loop Bandwidth            | -3 dB     | $A_V = +1, V_{IN} = 10\text{ mV p-p}, R_L = 2\text{ k}\Omega$                 |     | 5.9   |            | MHz                            |
| Phase Margin                           | $\Phi_M$  | $V_{IN} = 10\text{ mV p-p}, R_L = 2\text{ k}\Omega, A_V = +1$                 |     | 55    |            | Degrees                        |
| Total Harmonic Distortion Plus Noise   | THD + N   | $V_{IN} = 1\text{ V rms}, A_V = +1, R_L = 2\text{ k}\Omega, f = 1\text{ kHz}$ |     | 0.004 |            | %                              |
| <b>NOISE PERFORMANCE</b>               |           |   |     |       |            |                                |
| Voltage Noise                          | $e_n$ p-p | 0.1 Hz to 10 Hz   |     | 0.25  |            | $\mu\text{V p-p}$              |
| Voltage Noise Density                  | $e_n$     | $f = 1\text{ Hz}$   |     | 13    |            | $\text{nV}/\sqrt{\text{Hz}}$   |
|  |           | $f = 100\text{ Hz}$   |     | 7     |            | $\text{nV}/\sqrt{\text{Hz}}$   |
|  |           | $f = 1000\text{ Hz}$  |     | 6.9   |            | $\text{nV}/\sqrt{\text{Hz}}$   |
|  |           | $f = 1\text{ kHz}$  |     | 0.2   |            | $\text{pA}/\sqrt{\text{Hz}}$   |
| Current Noise Density                  | $i_n$     | $f = 1\text{ kHz}$  |     | 0.2   |            | $\text{pA}/\sqrt{\text{Hz}}$   |
| MULTIPLE AMPLIFIERS CHANNEL SEPARATION | $C_S$     | $f = 1\text{ kHz}, R_L = 10\text{ k}\Omega$                                   |     | -125  |            | dB                             |

ELECTRICAL CHARACTERISTICS,  $\pm 15\text{ V}$ 

$V_{SY} = \pm 15\text{ V}, V_{CM} = 0\text{ V}, T_A = 25^\circ\text{C}$ , unless otherwise noted.

Table 3.

| Parameter  | Symbol   | Test Conditions/Comments                       | Min                          | Typ  | Max  | Unit          |                          |  |               |
|--|----------|--|------------------------------|------|------|---------------|--------------------------|--|---------------|
| <b>INPUT CHARACTERISTICS</b>                         |          |  |                              |      |      |               |                          |  |               |
| Offset Voltage                                       | $V_{OS}$ | $-40^\circ\text{C} < T_A < +125^\circ\text{C}$ |                              | 10   | 35   | $\mu\text{V}$ |                          |  |               |
| <a href="#">ADA4077-1/ADA4077-2</a><br>B Grade, SOIC |          |  |                              |      |      |               | 65                       | $\mu\text{V}$                                  |               |
| A Grade, SOIC  |          |  |                              |      |      |               | 15                       | 50   | $\mu\text{V}$ |
| A Grade, MSOP  |          |  |                              |      |      |               | 105                      | $\mu\text{V}$                                  |               |
|  |          |  |                              |      |      |               | 50                       | 90   | $\mu\text{V}$ |
| <a href="#">ADA4077-4</a><br>A Grade, SOIC           |          |  |                              |      |      |               | 220                      | $\mu\text{V}$                                  |               |
| A Grade, TSSOP                                       |          |  |                              |      |      |               | 15                       | 50   | $\mu\text{V}$ |
|  |          |  |                              |      |      |               | 105                      | $\mu\text{V}$                                  |               |
|  |          |  |                              |      |      |               | 15                       | 120  | $\mu\text{V}$ |
| Offset Voltage Drift                                 |          |  |                              |      |      |               | $\Delta V_{OS}/\Delta T$ | $-40^\circ\text{C} < T_A < +125^\circ\text{C}$ |               |
| <a href="#">ADA4077-1/ADA4077-2</a><br>B Grade, SOIC | 0.1      | 0.25   | $\mu\text{V}/^\circ\text{C}$ |      |      |               |                          |  |               |
| A Grade, SOIC  | 0.25     | 0.55   | $\mu\text{V}/^\circ\text{C}$ |      |      |               |                          |  |               |
| A Grade, MSOP  | 0.5      | 1.2  | $\mu\text{V}/^\circ\text{C}$ |      |      |               |                          |  |               |
| <a href="#">ADA4077-4</a><br>A Grade, SOIC           | 0.4      | 0.75   | $\mu\text{V}/^\circ\text{C}$ |      |      |               |                          |  |               |
| A Grade, TSSOP                                       | 0.5      | 1.2  | $\mu\text{V}/^\circ\text{C}$ |      |      |               |                          |  |               |
| Input Bias Current                                   | $I_B$    | $-40^\circ\text{C} < T_A < +125^\circ\text{C}$ |                              | -1   | -0.4 | +1            |                          |  |               |
|  |          |  |                              |      |      |               | -1.5                     | +1.5   | nA            |
| Input Offset Current                                 | $I_{OS}$ | $-40^\circ\text{C} < T_A < +125^\circ\text{C}$ |                              | -0.5 | +0.1 | +0.5          | nA                       |  |               |

## SPECIFICATIONS

Table 3.

| Parameter                              | Symbol             | Test Conditions/Comments   | Min   | Typ   | Max   | Unit    |
|--|--------------------|--|-------|-------|-------|---------|
| Input Voltage Range                    |                    | $-40^{\circ}\text{C} < T_A < +125^{\circ}\text{C}$   | -1    |       | +1    | nA      |
| Common-Mode Rejection Ratio            | CMRR               | $V_{\text{CM}} = -13.8\text{ V to }+13\text{ V}$<br>$-40^{\circ}\text{C} < T_A < +125^{\circ}\text{C}$                 | -13.8 | 150   | +13   | V       |
| Large Signal Voltage Gain              | Av                 | $R_L = 2\text{ k}\Omega, V_O = -13.0\text{ V to }+13.0\text{ V}$<br>$-40^{\circ}\text{C} < T_A < +125^{\circ}\text{C}$ | 130   | 130   |       | dB      |
| ADA4077-1/ADA4077-2 (SOIC, MSOP)       |                    |  | 125   | 130   |       | dB      |
| ADA4077-4 (SOIC, TSSOP)                |                    |  | 122   | 130   |       | dB      |
| Input Capacitance                      | C <sub>INDM</sub>  | Differential mode  |       | 3     |       | pF      |
|  | C <sub>INCM</sub>  | Common mode  |       | 5     |       | pF      |
| Input Resistance                       | R <sub>IN</sub>    | Common mode  |       | 70    |       | GΩ      |
| OUTPUT CHARACTERISTICS                 |                    |  |       |       |       |         |
| Output Voltage High                    | V <sub>OH</sub>    | I <sub>L</sub> = 1 mA<br>$-40^{\circ}\text{C} < T_A < +125^{\circ}\text{C}$  | 13.5  |       |       | V       |
| Output Voltage Low                     | V <sub>OL</sub>    | I <sub>L</sub> = 1 mA<br>$-40^{\circ}\text{C} < T_A < +125^{\circ}\text{C}$  | 13.2  |       | -13.5 | V       |
| Output Current                         | I <sub>OUT</sub>   | V <sub>DROPOUT</sub> < 1.2 V   |       | ±10   |       | mA      |
| Short-Circuit Current                  | I <sub>SC</sub>    | T <sub>A</sub> = 25°C  |       | 22    |       | mA      |
| Closed-Loop Output Impedance           | Z <sub>OUT</sub>   | f = 1 kHz, A <sub>V</sub> = +1   |       | 0.05  |       | Ω       |
| POWER SUPPLY                           |                    |  |       |       |       |         |
| Power Supply Rejection Ratio           | PSRR               | V <sub>S</sub> = ±2.5 V to ±18 V<br>$-40^{\circ}\text{C} < T_A < +125^{\circ}\text{C}$                                 | 123   | 128   |       | dB      |
| Supply Current per Amplifier           | I <sub>SY</sub>    | V <sub>O</sub> = 0 V<br>$-40^{\circ}\text{C} < T_A < +125^{\circ}\text{C}$   | 120   | 400   | 500   | μA      |
|  |                    |  |       |       | 650   | μA      |
| DYNAMIC PERFORMANCE                    |                    |  |       |       |       |         |
| Slew Rate                              | SR                 | R <sub>L</sub> = 2 kΩ  |       | 1.2   |       | V/μs    |
| Settling Time to 0.01%                 | t <sub>s</sub>     | V <sub>IN</sub> = 10 V p-p, R <sub>L</sub> = 2 kΩ, A <sub>V</sub> = -1   |       | 16    |       | μs      |
| Settling Time to 0.1%                  | t <sub>s</sub>     | V <sub>IN</sub> = 10 V p-p, R <sub>L</sub> = 2 kΩ, A <sub>V</sub> = -1   |       | 10    |       | μs      |
| Gain Bandwidth Product                 | GBP                | V <sub>IN</sub> = 10 mV p-p, R <sub>L</sub> = 2 kΩ, A <sub>V</sub> = +100  |       | 3.6   |       | MHz     |
| Unity-Gain Crossover                   | UGC                | V <sub>IN</sub> = 10 mV p-p, R <sub>L</sub> = 2 kΩ, A <sub>V</sub> = +1  |       | 3.9   |       | MHz     |
| -3 dB Closed-Loop Bandwidth            | -3 dB              | A <sub>V</sub> = +1, V <sub>IN</sub> = 10 mV p-p, R <sub>L</sub> = 2 kΩ  |       | 5.5   |       | MHz     |
| Phase Margin                           | ΦM                 | V <sub>IN</sub> = 10 mV p-p, R <sub>L</sub> = 2 kΩ, A <sub>V</sub> = +1  |       | 58    |       | Degrees |
| Total Harmonic Distortion Plus Noise   | THD + N            | V <sub>IN</sub> = 1 V rms, A <sub>V</sub> = +1, R <sub>L</sub> = 2 kΩ,<br>f = 1 kHz                                    |       | 0.004 |       | %       |
| NOISE PERFORMANCE                      |                    |  |       |       |       |         |
| Voltage Noise                          | e <sub>n</sub> p-p | 0.1 Hz to 10 Hz  |       | 0.25  |       | μV p-p  |
| Voltage Noise Density                  | e <sub>n</sub>     | f = 1 Hz   |       | 13    |       | nV/√Hz  |
|  |                    | f = 100 Hz   |       | 7     |       | nV/√Hz  |
|  |                    | f = 1000 Hz  |       | 6.9   |       | nV/√Hz  |
| Current Noise Density                  | i <sub>n</sub>     | f = 1 kHz  |       | 0.2   |       | pA/√Hz  |
| MULTIPLE AMPLIFIERS CHANNEL SEPARATION | C <sub>S</sub>     | f = 1 kHz, R <sub>L</sub> = 10 kΩ  |       | -125  |       | dB      |

## ABSOLUTE MAXIMUM RATINGS

Table 4.

| Parameter  | Rating          |
|--|-----------------|
| Supply Voltage   | 36 V            |
| Input Voltage  | $\pm V_{SY}$    |
| Input Current <sup>1</sup>                             | $\pm 10$ mA     |
| Differential Input Voltage                             | $\pm V_{SY}$    |
| Output Short-Circuit Duration to GND                   | Indefinite      |
| Storage Temperature Range                              | -65°C to +150°C |
| Operating Temperature Range                            | -40°C to +125°C |
| Junction Temperature Range                             | -65°C to +150°C |
| Maximum Reflow Temperature (MSL1 Rating) <sup>2</sup>  | 260°C           |
| Lead Temperature, Soldering (10 sec)                   | 300°C           |
| Electrostatic Discharge (ESD)                          |                 |
| Human Body Model (HBM) <sup>3</sup>                    | 6 kV            |
| Field Induced Charge Device Model (FICDM) <sup>4</sup> | 1.25 kV         |

<sup>1</sup> The input pins have clamp diodes to the power supply pins and to each other. Limit the input current to 10 mA or less whenever input signals exceed the power supply rail by 0.3 V.

<sup>2</sup> IPC/JEDEC J-STD-020 applicable standard

<sup>3</sup> ESDA/JEDEC JS-001-2011 applicable standard.

<sup>4</sup> JESD22-C101 (ESD FICDM standard of JEDEC) applicable standard.

Stresses at or above those listed under Absolute Maximum Ratings may cause permanent damage to the product. This is a stress rating only; functional operation of the product at these or any other conditions above those indicated in the operational section of this specification is not implied. Operation beyond the maximum operating conditions for extended periods may affect product reliability.

## THERMAL RESISTANCE

$\theta_{JA}$  is specified for the worst case conditions, that is, a device soldered in a circuit board for surface-mount packages.

Table 5. Thermal Resistance

| Package Type  | $\theta_{JA}$ | $\theta_{JC}$ | Unit |
|---------------|---------------|---------------|------|
| 8-Lead MSOP   | 190           | 44            | °C/W |
| 8-Lead SOIC   | 158           | 43            | °C/W |
| 14-Lead TSSOP | 240           | 43            | °C/W |
| 14-Lead SOIC  | 115           | 36            | °C/W |

## ESD CAUTION



**ESD (electrostatic discharge) sensitive device.** Charged devices and circuit boards can discharge without detection. Although this product features patented or proprietary protection circuitry, damage may occur on devices subjected to high energy ESD. Therefore, proper ESD precautions should be taken to avoid performance degradation or loss of functionality.

## PIN CONFIGURATIONS AND FUNCTION DESCRIPTIONS

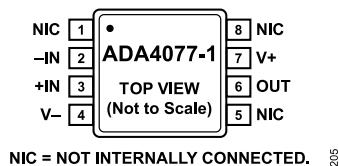

Figure 4. ADA4077-1 Pin Configuration, 8-Lead MSOP (RM-8)

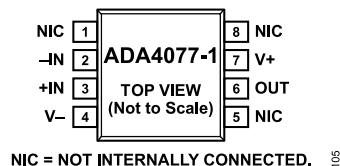

Figure 5. ADA4077-1 Pin Configuration, 8-Lead SOIC (R-8)

Table 6. ADA4077-1 Pin Function Descriptions, 8-Lead MSOP and 8-Lead SOIC

| Pin No. | Mnemonic | Description               |
|---------|----------|---------------------------|
| 1, 5, 8 | NIC      | Not internally connected. |
| 2       | -IN      | Inverting Input.          |
| 3       | +IN      | Noninverting Input.       |
| 4       | V-       | Negative Supply Voltage.  |
| 6       | OUT      | Output.                   |
| 7       | V+       | Positive Supply Voltage.  |

**PIN CONFIGURATIONS AND FUNCTION DESCRIPTIONS**

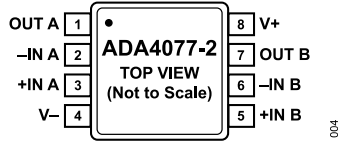

Figure 6. ADA4077-2 Pin Configuration, 8-Lead MSOP

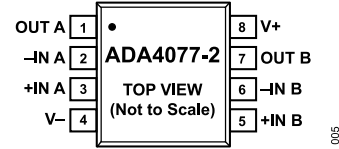

Figure 7. ADA4077-2 Pin Configuration, 8-Lead SOIC

Table 7. ADA4077-2 Pin Function Descriptions, 8-Lead MSOP and 8-Lead SOIC

| Pin No. | Mnemonic | Description                   |
|---------|----------|-------------------------------|
| 1       | OUT A    | Output Channel A.             |
| 2       | -IN A    | Inverting Input Channel A.    |
| 3       | +IN A    | Noninverting Input Channel A. |
| 4       | V-       | Negative Supply Voltage.      |
| 5       | +IN B    | Noninverting Input Channel B. |
| 6       | -IN B    | Inverting Input Channel B.    |
| 7       | OUT B    | Output Channel B.             |
| 8       | V+       | Positive Supply Voltage.      |



PIN CONFIGURATIONS AND FUNCTION DESCRIPTIONS

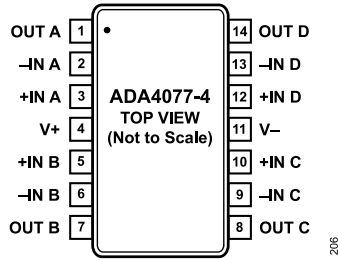

Figure 8. ADA4077-4 Pin Configuration, 14-Lead TSSOP

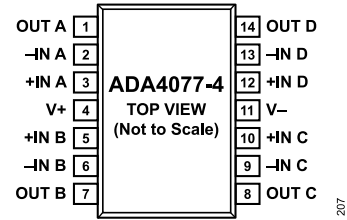

Figure 9. ADA4077-4 Pin Configuration, 14-Lead SOIC

Table 8. ADA4077-4 Pin Function Descriptions, 14-Lead TSSOP and 14-Lead SOIC

| Pin No. | Mnemonic | Description               |
|---------|----------|---------------------------|
| 1       | OUT A    | Output Channel A.         |
| 2       | -IN A    | Negative Input Channel A. |
| 3       | +IN A    | Positive Input Channel A. |
| 4       | V+       | Positive Supply Voltage.  |
| 5       | +IN B    | Positive Input Channel B. |
| 6       | -IN B    | Negative Input Channel B. |
| 7       | OUT B    | Output Channel B.         |
| 8       | OUT C    | Output Channel C.         |
| 9       | -IN C    | Negative Input Channel C. |
| 10      | +IN C    | Positive Input Channel C. |
| 11      | V-       | Negative Supply Voltage.  |
| 12      | +IN D    | Positive Input Channel D. |
| 13      | -IN D    | Negative Input Channel D. |
| 14      | OUT D    | Output Channel D.         |

TYPICAL PERFORMANCE CHARACTERISTICS

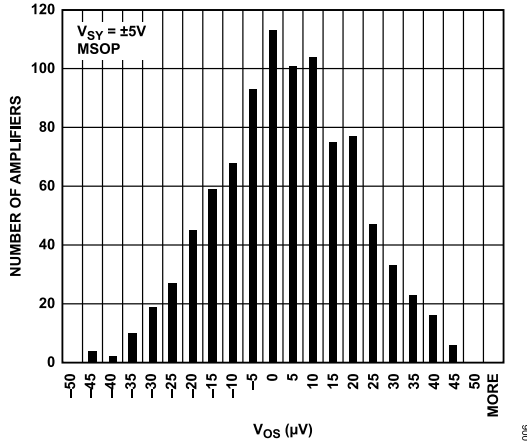

Figure 10. ADA4077-2 Offset Voltage ( $V_{OS}$ ) Distribution,  $V_{SY} = \pm 5 V$

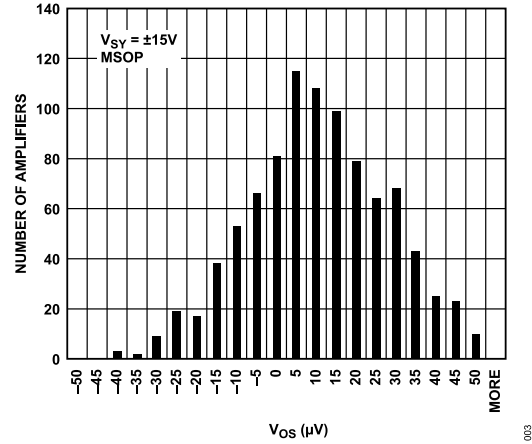

Figure 13. ADA4077-2 Offset Voltage ( $V_{OS}$ ) Distribution,  $V_{SY} = \pm 15 V$

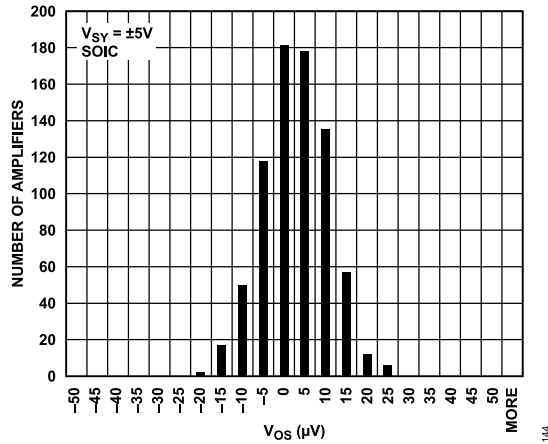

Figure 11. Offset Voltage ( $V_{OS}$ ) Distribution,  $V_{SY} = \pm 5 V$

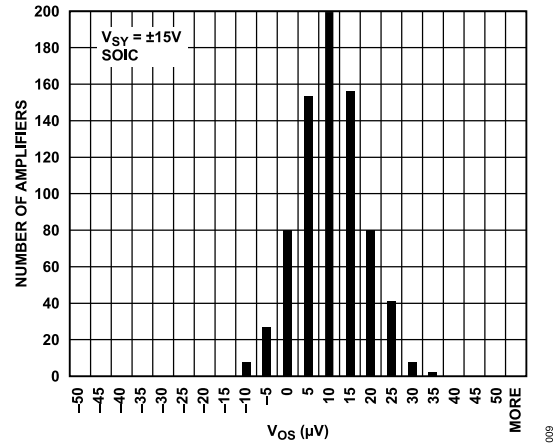

Figure 14. Offset Voltage ( $V_{OS}$ ) Distribution,  $V_{SY} = \pm 15 V$

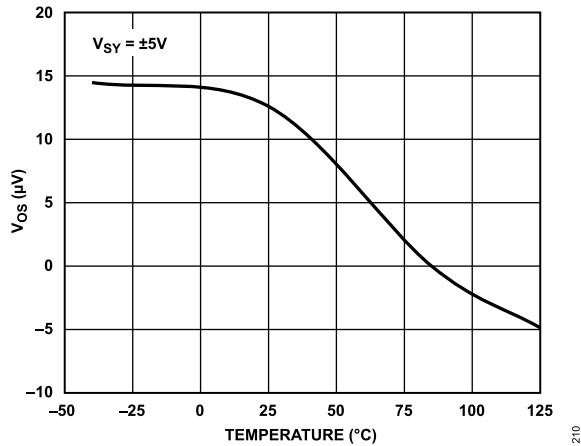

Figure 12. Offset Voltage ( $V_{OS}$ ) vs. Temperature,  $V_{SY} = \pm 5 V$

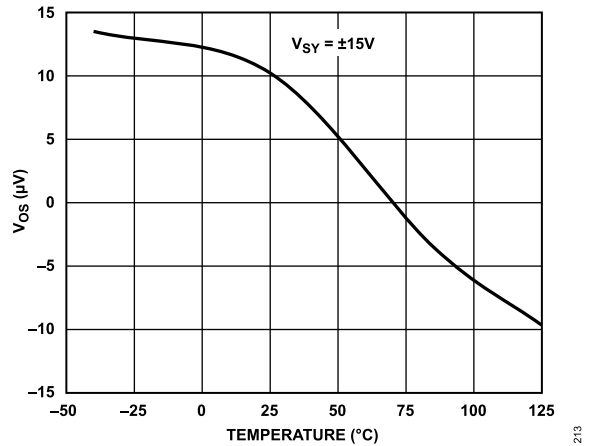

Figure 15. Offset Voltage ( $V_{OS}$ ) vs. Temperature,  $V_{SY} = \pm 15 V$

TYPICAL PERFORMANCE CHARACTERISTICS

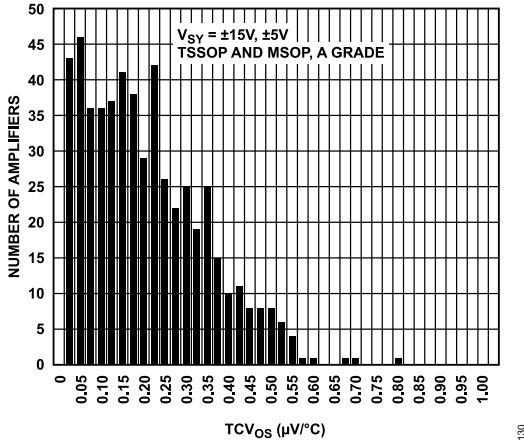

Figure 16.  $TCV_{OS}$  Distribution (TSSOP and MSOP, A Grade)

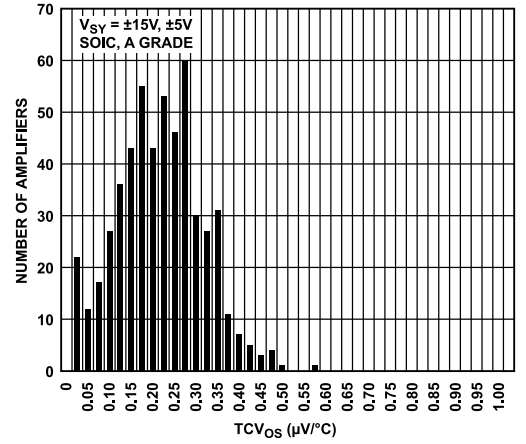

Figure 19.  $TCV_{OS}$  Distribution (SOIC, A Grade)

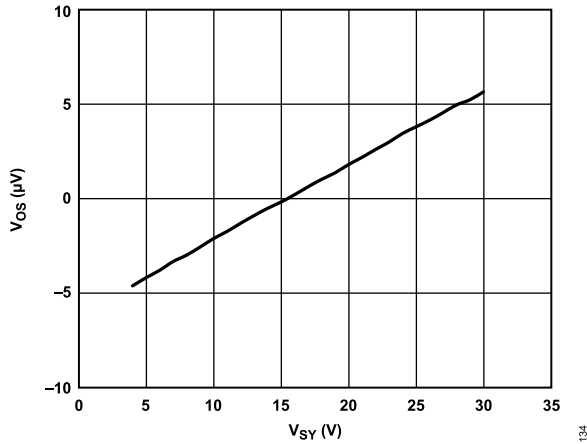

Figure 17. Offset Voltage ( $V_{OS}$ ) vs. Power Supply Voltage ( $V_{SY}$ )

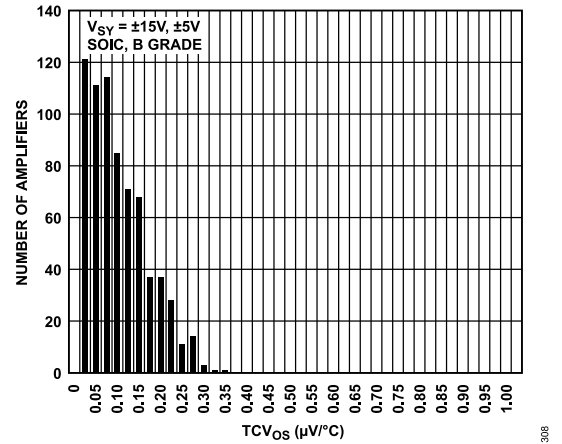

Figure 20.  $TCV_{OS}$  Distribution (SOIC, B Grade)

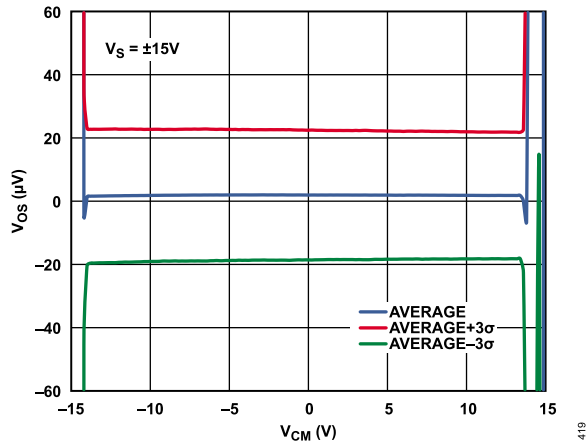

Figure 18. Offset Voltage ( $V_{OS}$ ) vs. Common-Mode Voltage ( $V_{CM}$ ),  $V_{SY} = \pm 15 V$

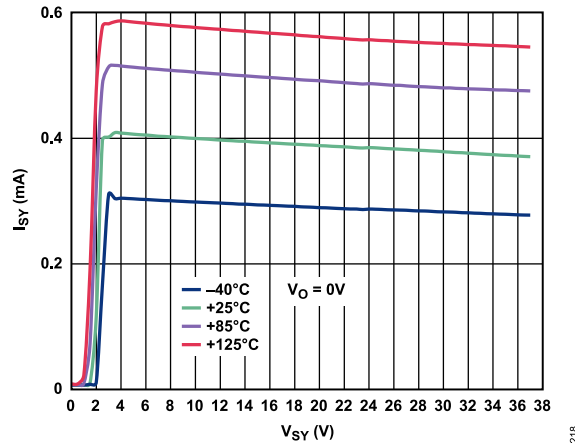

Figure 21. Supply Current per Amplifier ( $I_{SY}$ ) vs. Power Supply Voltage ( $V_{SY}$ )

TYPICAL PERFORMANCE CHARACTERISTICS

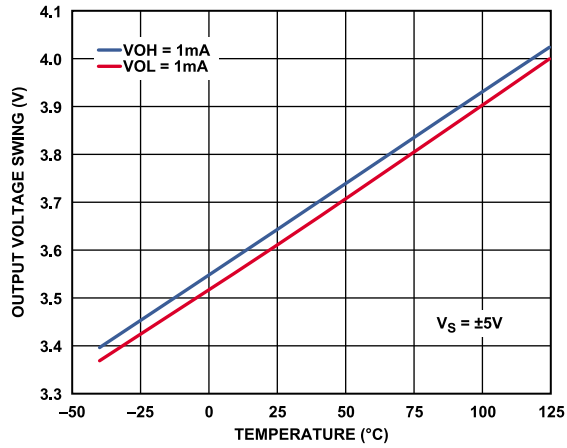

Figure 22. Output Voltage Swing vs. Temperature,  $V_{SY} = \pm 5 V$

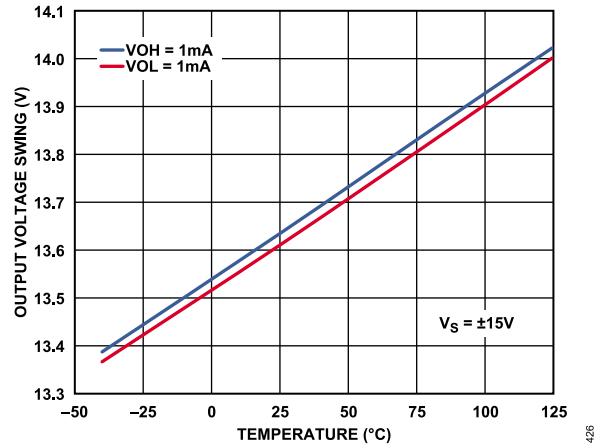

Figure 25. Output Voltage Swing vs. Temperature,  $V_{SY} = \pm 15 V$

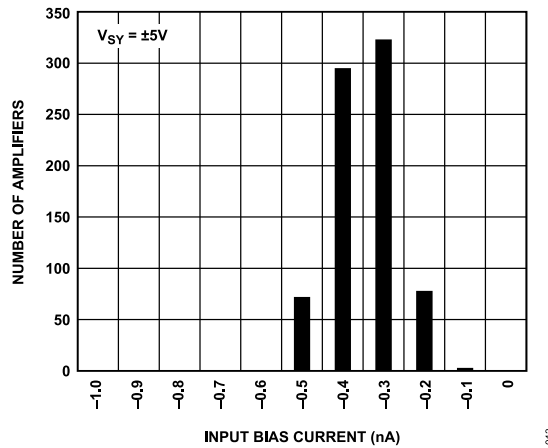

Figure 23. Input Bias Current Distribution,  $V_{SY} = \pm 5 V$

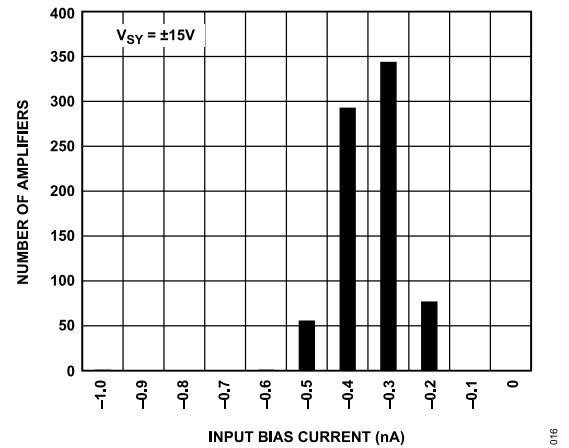

Figure 26. Input Bias Current Distribution,  $V_{SY} = \pm 15 V$

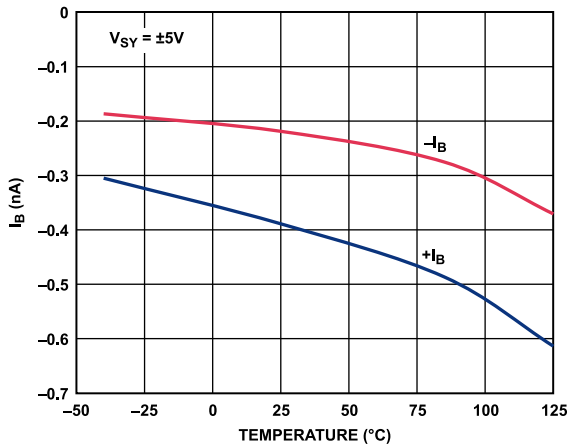

Figure 24. Input Bias Current ( $I_B$ ) vs. Temperature,  $V_{SY} = \pm 5 V$

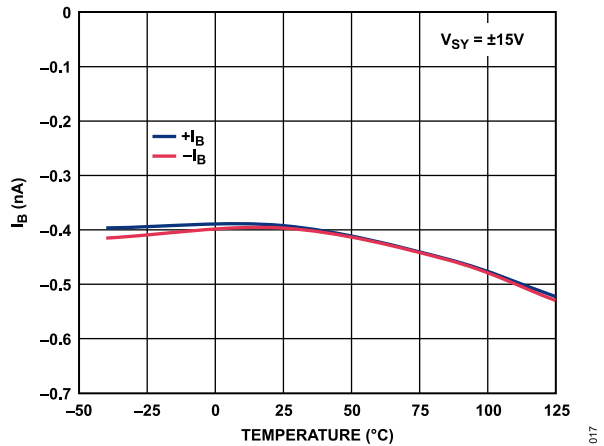

Figure 27. Input Bias Current ( $I_B$ ) vs. Temperature,  $V_{SY} = \pm 15 V$

TYPICAL PERFORMANCE CHARACTERISTICS

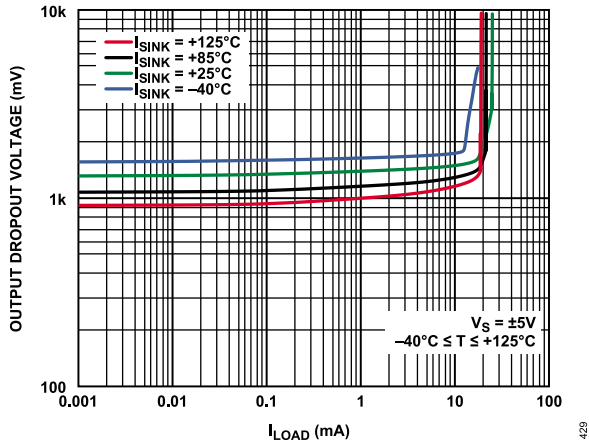

Figure 28. Output Dropout Voltage vs.  $I_{LOAD}$ , Sink Current,  $V_{SY} = \pm 5V$

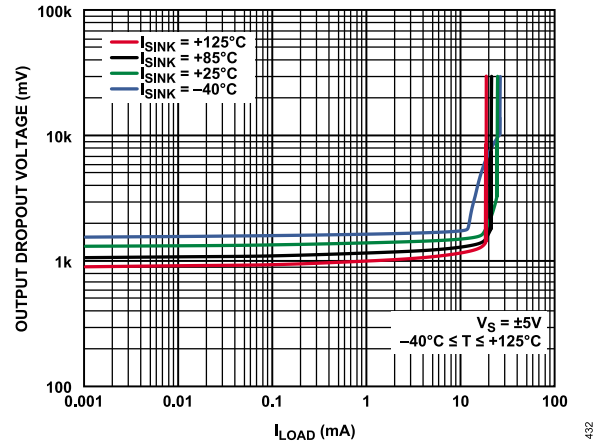

Figure 31. Output Dropout Voltage vs.  $I_{LOAD}$ , Sink Current,  $V_{SY} = \pm 15V$

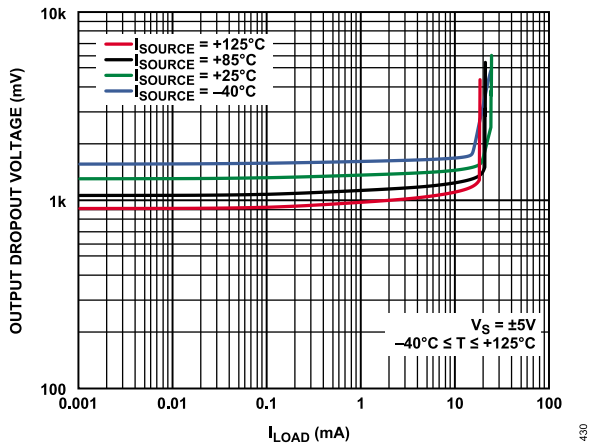

Figure 29. Output Dropout Voltage vs.  $I_{LOAD}$ , Source Current,  $V_{SY} = \pm 5V$

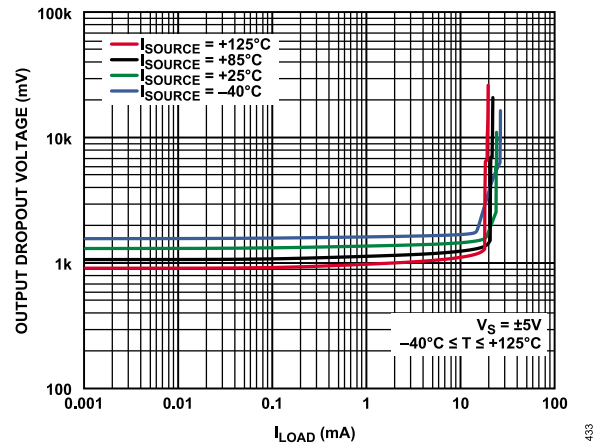

Figure 32. Output Dropout Voltage vs.  $I_{LOAD}$ , Source Current,  $V_{SY} = \pm 15V$

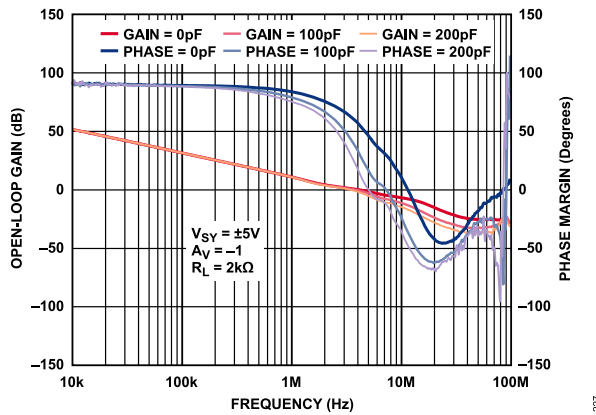

Figure 30. Open-Loop Gain and Phase Margin vs. Frequency,  $V_{SY} = \pm 5V$

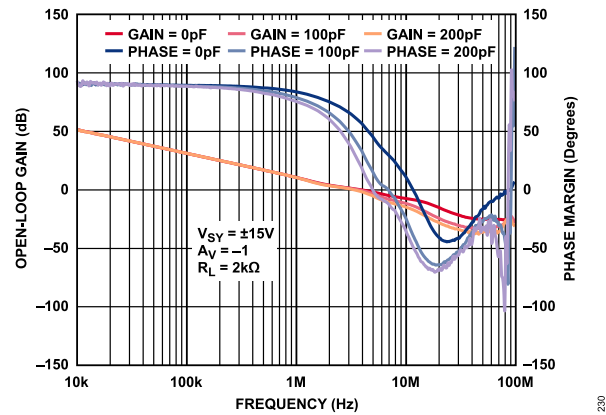

Figure 33. Open-Loop Gain and Phase Margin vs. Frequency,  $V_{SY} = \pm 15V$

TYPICAL PERFORMANCE CHARACTERISTICS

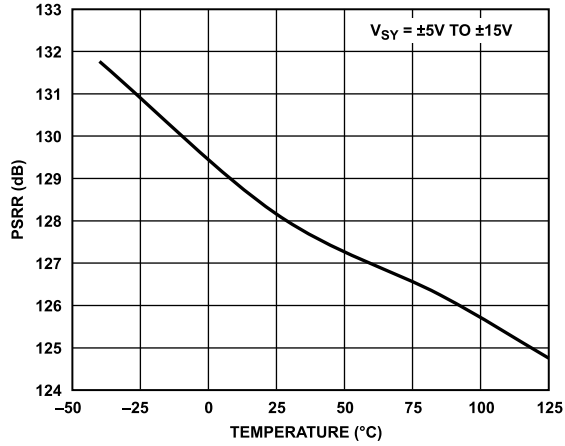

Figure 34. PSRR vs. Temperature,  $V_{SY} = \pm 5 V$  to  $\pm 15 V$

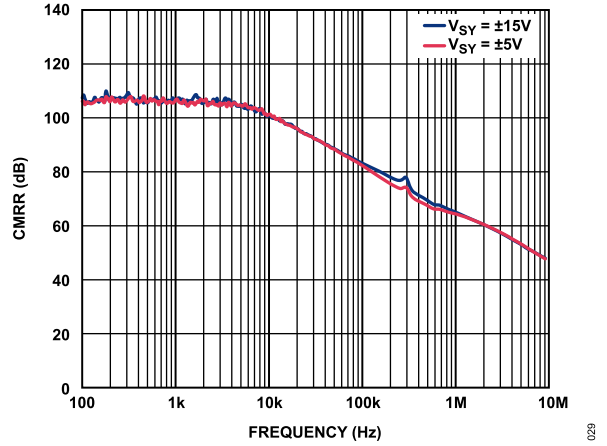

Figure 37. CMRR vs. Frequency,  $V_{SY} = \pm 5 V$  and  $V_{SY} = \pm 15 V$

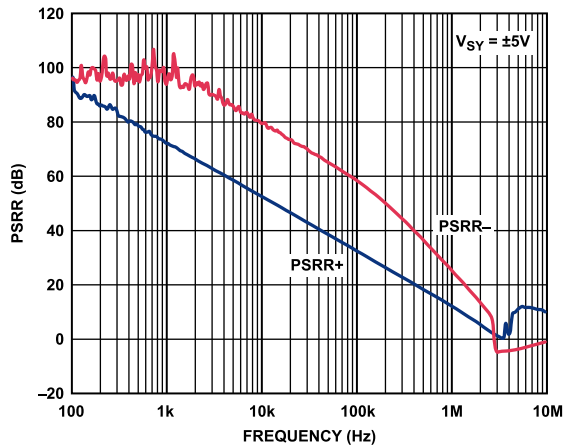

Figure 35. PSRR vs. Frequency,  $V_{SY} = \pm 5 V$

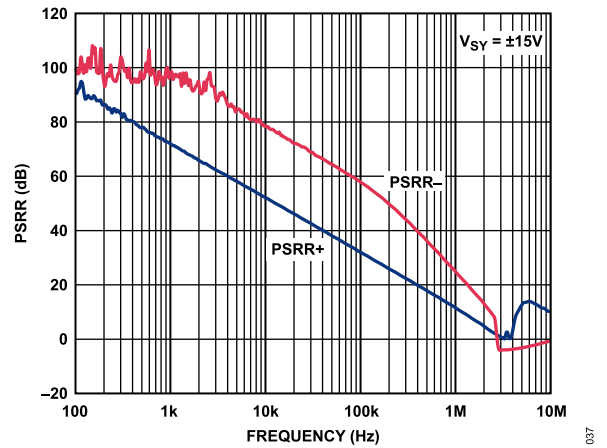

Figure 38. PSRR vs. Frequency,  $V_{SY} = \pm 15 V$

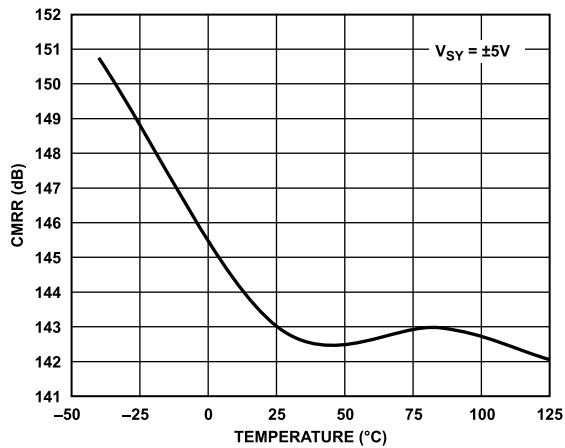

Figure 36. CMRR vs. Temperature,  $V_{SY} = \pm 5 V$

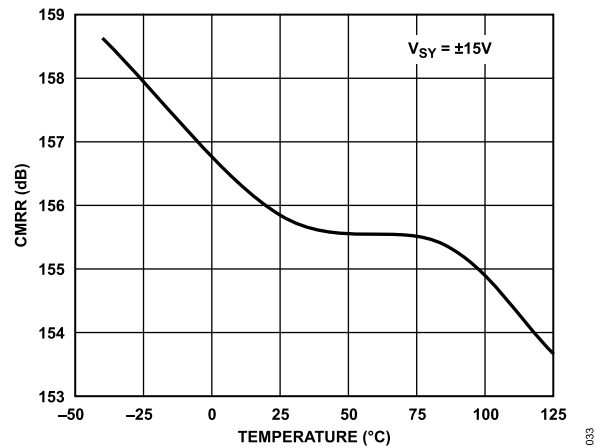

Figure 39. CMRR vs. Temperature,  $V_{SY} = \pm 15 V$

TYPICAL PERFORMANCE CHARACTERISTICS

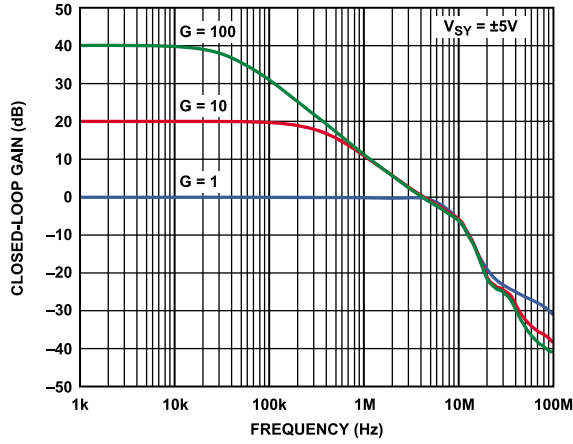

Figure 40. Closed-Loop Gain vs. Frequency,  $V_{SY} = \pm 5\text{ V}$

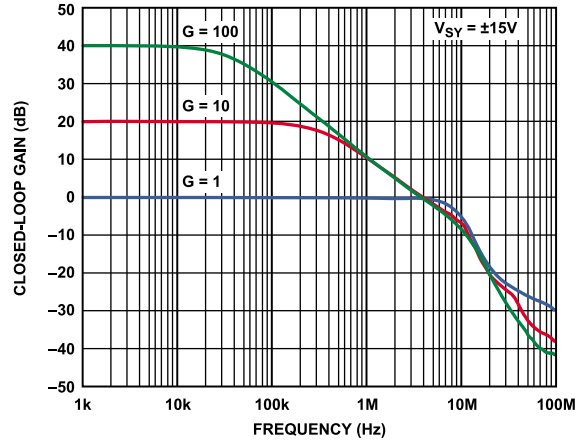

Figure 43. Closed-Loop Gain vs. Frequency,  $V_{SY} = \pm 15\text{ V}$

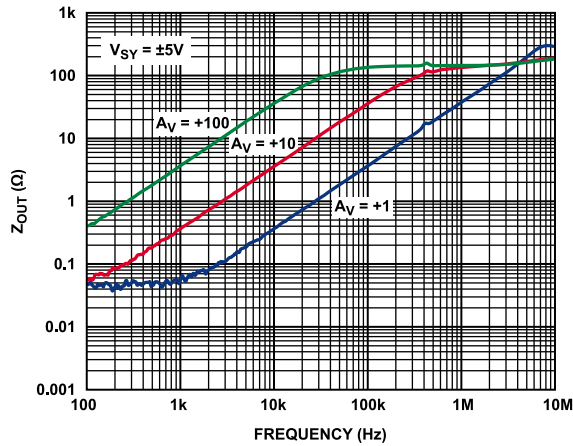

Figure 41. Output Impedance ( $Z_{OUT}$ ) vs. Frequency,  $V_{SY} = \pm 5\text{ V}$

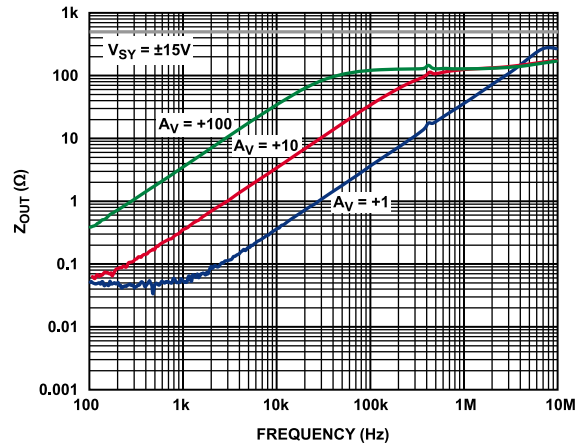

Figure 44. Output Impedance ( $Z_{OUT}$ ) vs. Frequency,  $V_{SY} = \pm 15\text{ V}$

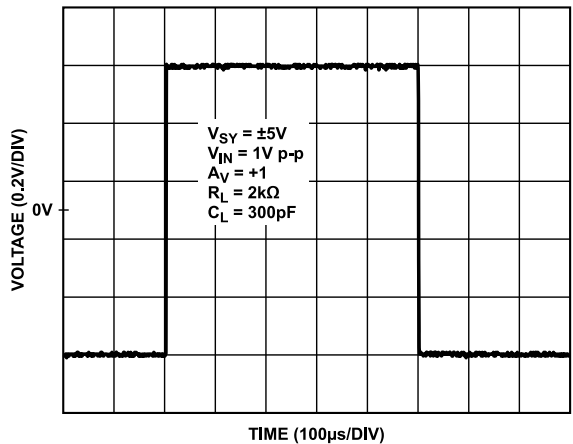

Figure 42. Large Signal Transient Response,  $V_{SY} = \pm 5\text{ V}$

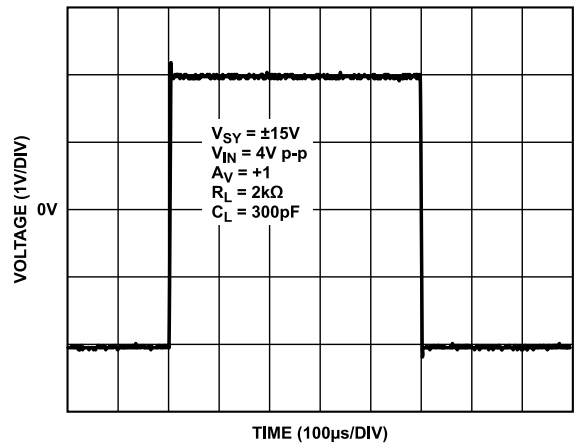

Figure 45. Large Signal Transient Response,  $V_{SY} = \pm 15\text{ V}$

TYPICAL PERFORMANCE CHARACTERISTICS

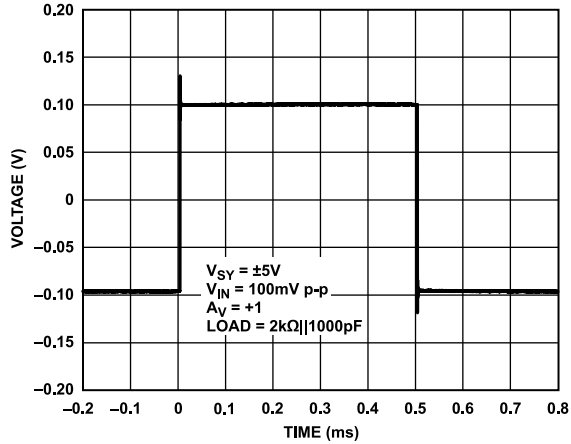

Figure 46. Small Signal Transient Response,  $V_{SY} = \pm 5\text{ V}$

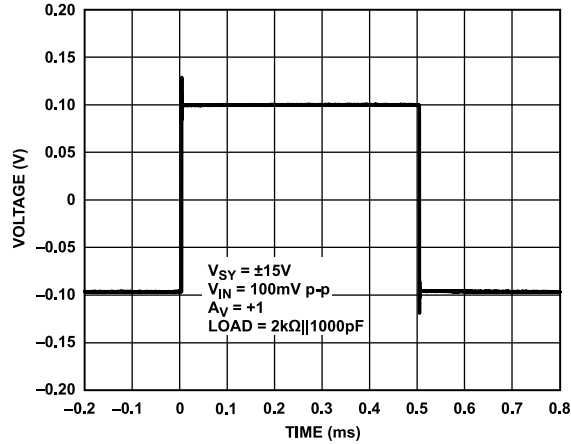

Figure 49. Small Signal Transient Response,  $V_{SY} = \pm 15\text{ V}$

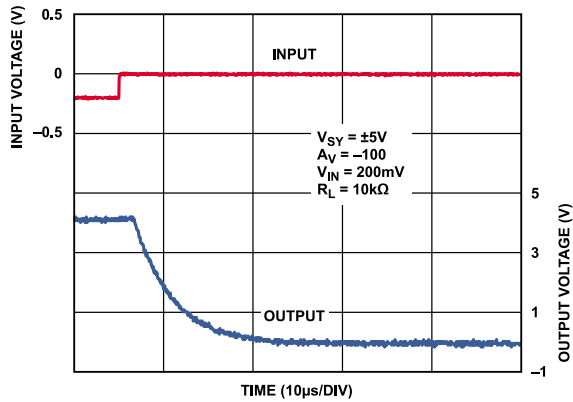

Figure 47. Positive Overload Recovery,  $V_{SY} = \pm 5\text{ V}$

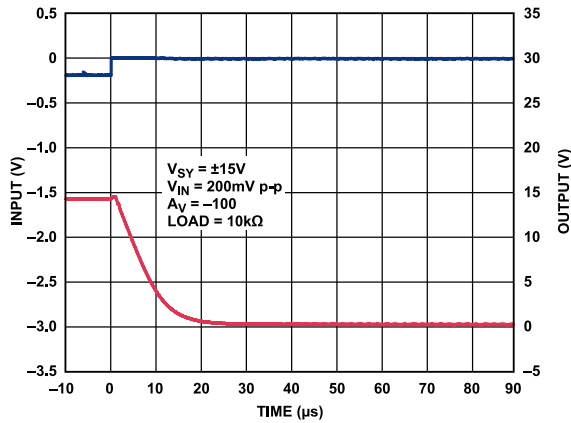

Figure 50. Positive Overload Recovery,  $V_{SY} = \pm 15\text{ V}$

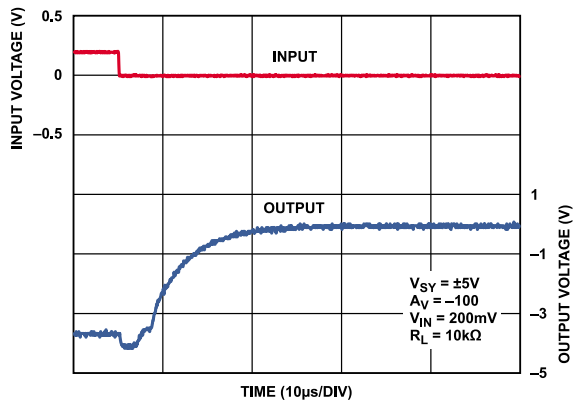

Figure 48. Negative Overload Recovery,  $V_{SY} = \pm 5\text{ V}$

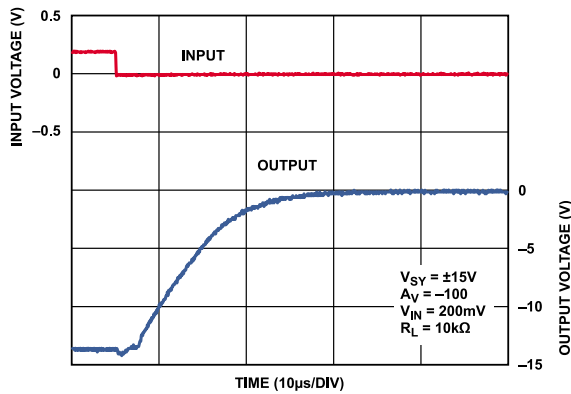

Figure 51. Negative Overload Recovery,  $V_{SY} = \pm 15\text{ V}$



TYPICAL PERFORMANCE CHARACTERISTICS

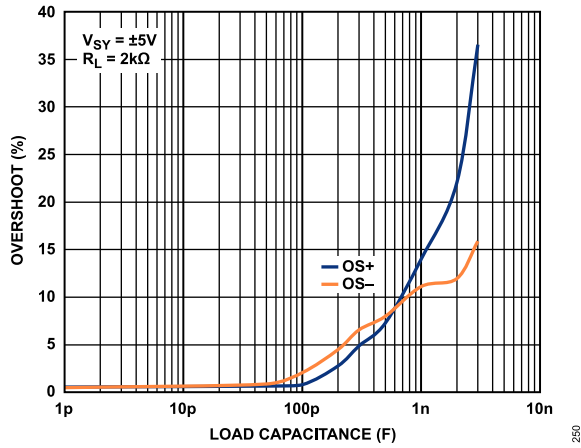

Figure 52. Small Signal Overshoot vs. Load Capacitance,  $V_{SY} = \pm 5 V$

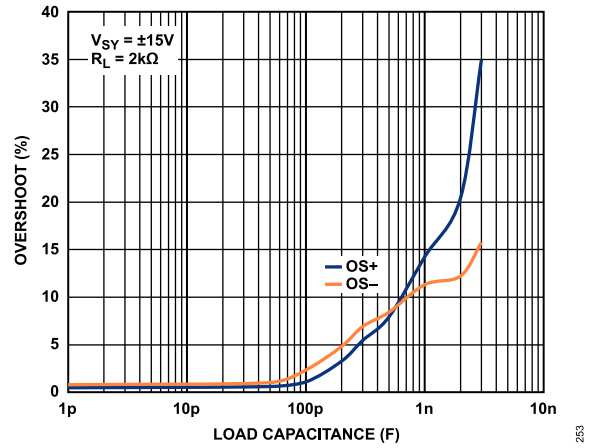

Figure 55. Small Signal Overshoot vs. Load Capacitance,  $V_{SY} = \pm 15 V$

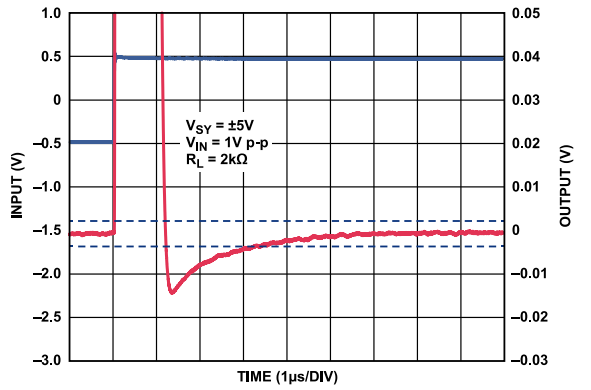

Figure 53. Positive 0.1% Settling Time,  $V_{SY} = \pm 5 V$

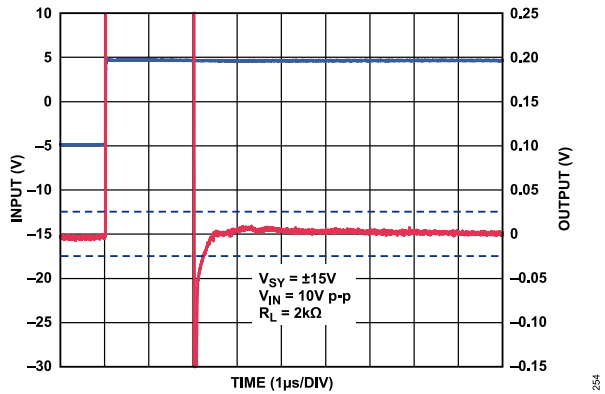

Figure 56. Positive 0.1% Settling Time,  $V_{SY} = \pm 15 V$

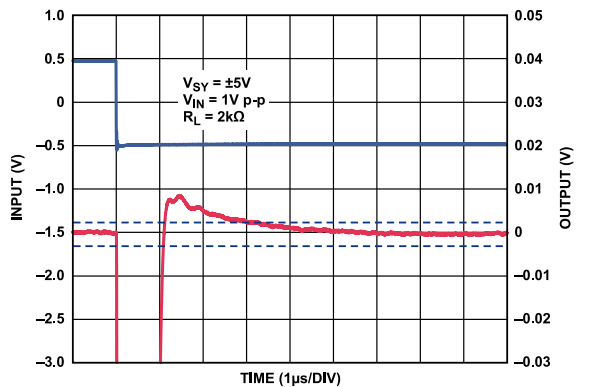

Figure 54. Negative 0.1% Settling Time,  $V_{SY} = \pm 5 V$

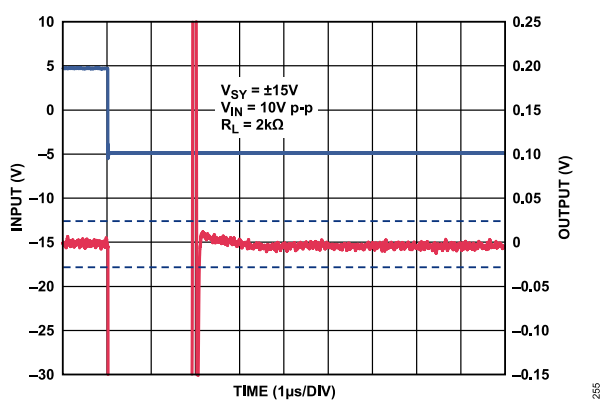

Figure 57. Negative 0.1% Settling Time,  $V_{SY} = \pm 15 V$

TYPICAL PERFORMANCE CHARACTERISTICS

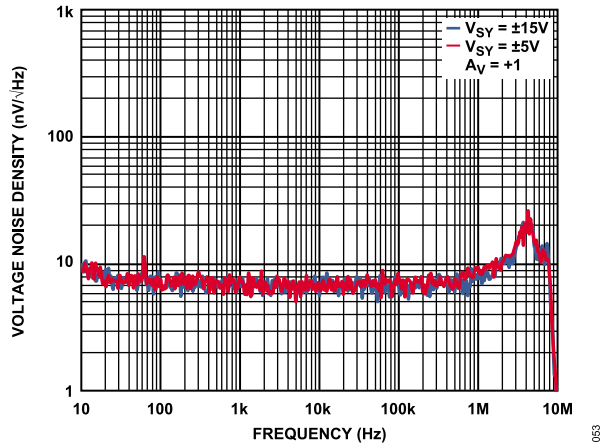

Figure 58. Voltage Noise Density vs. Frequency,  $V_{SY} = \pm 5\text{ V}$  and  $V_{SY} = \pm 15\text{ V}$

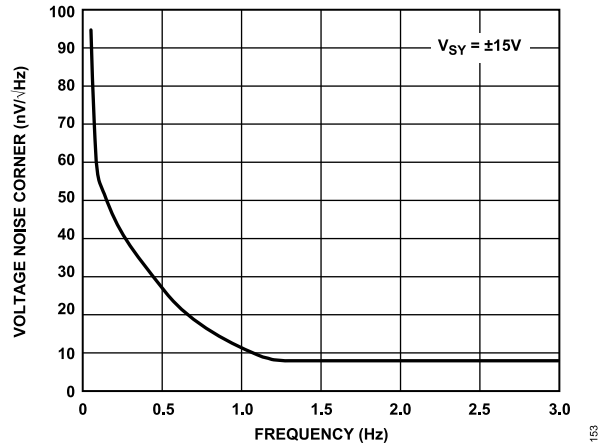

Figure 61. Voltage Noise Corner vs. Frequency,  $V_{SY} = \pm 15\text{ V}$  and  $V_{SY} = \pm 5\text{ V}$

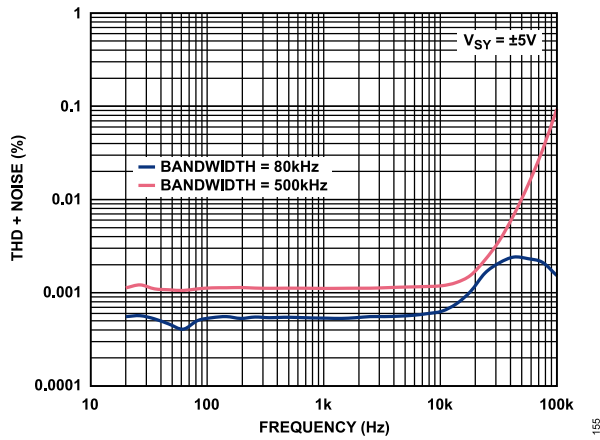

Figure 59. THD + Noise vs. Frequency,  $V_{SY} = \pm 5\text{ V}$

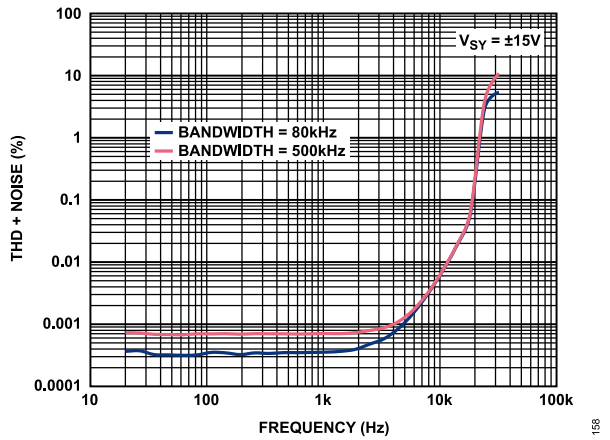

Figure 62. THD + Noise vs. Frequency,  $V_{SY} = \pm 15\text{ V}$

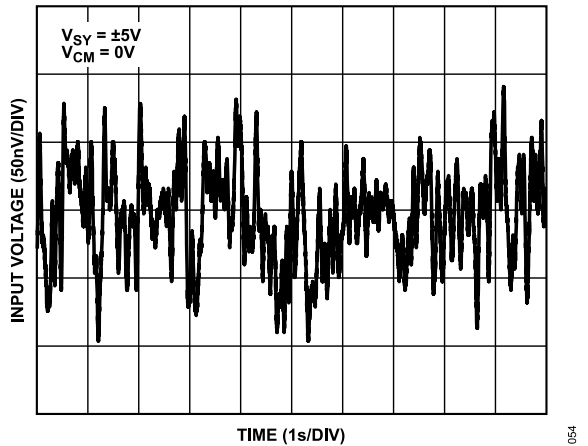

Figure 60. 0.1 Hz to 10 Hz Noise,  $V_{SY} = \pm 5\text{ V}$

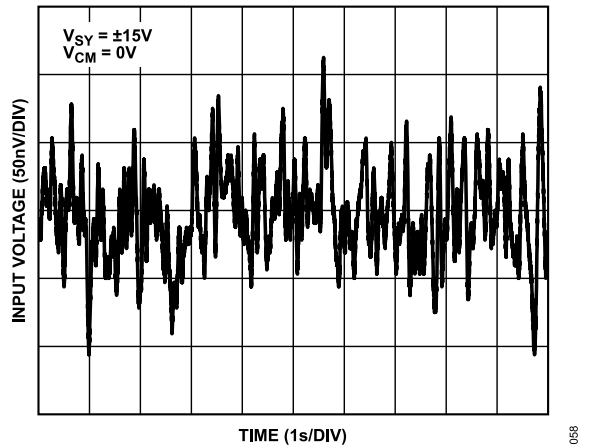

Figure 63. 0.1 Hz to 10 Hz Noise,  $V_{SY} = \pm 15\text{ V}$

TYPICAL PERFORMANCE CHARACTERISTICS

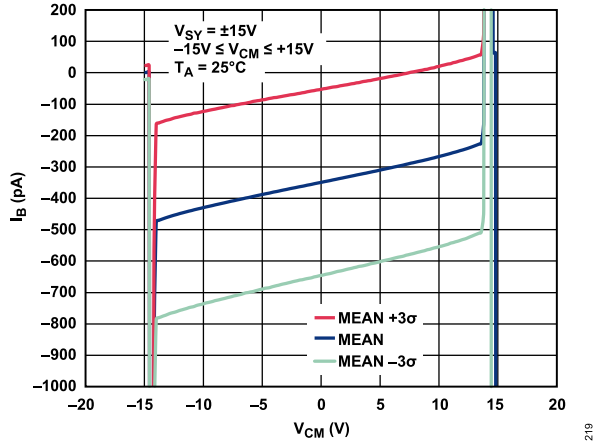

Figure 64. Input Bias Current ( $I_B$ ) vs. Common-Mode Voltage ( $V_{CM}$ )

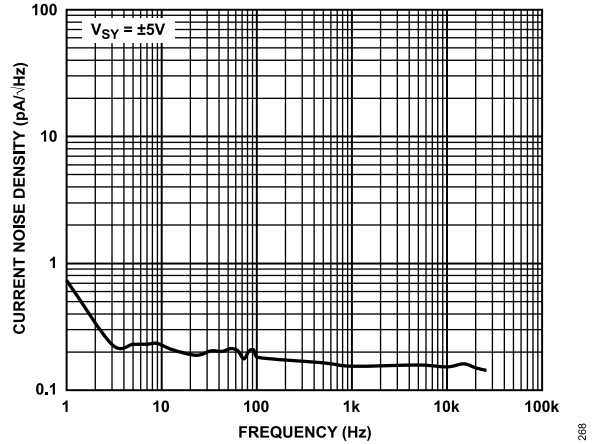

Figure 67. Current Noise Density,  $V_{SY} = \pm 5 V$

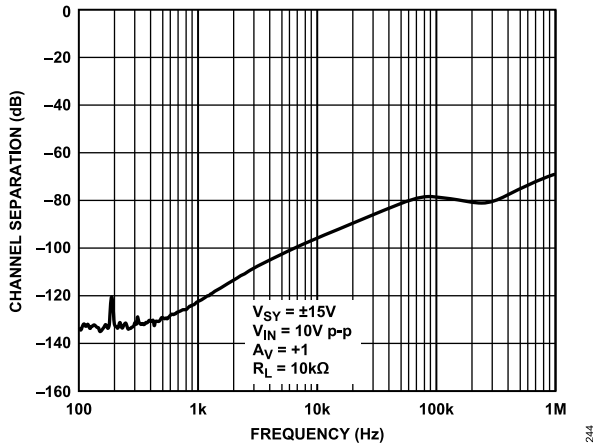

Figure 65. Channel Separation,  $V_{SY} = \pm 15 V$  (See Figure 69)

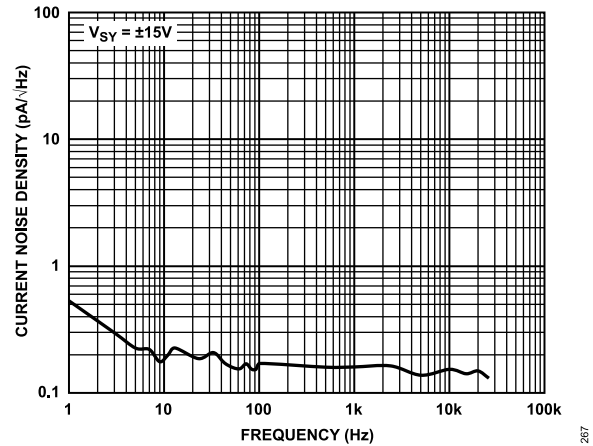

Figure 66. Current Noise Density,  $V_{SY} = \pm 15 V$

## TEST CIRCUIT

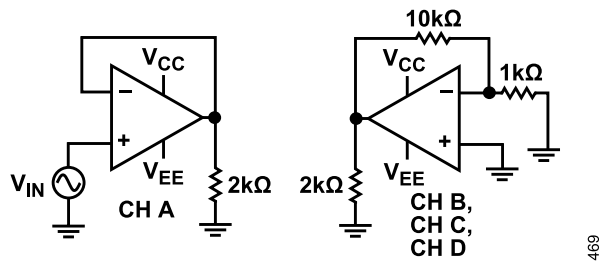

Figure 68. Test Circuit for Channel Separation vs. Frequency

469

## THEORY OF OPERATION

The ADA4077-1/ADA4077-2/ADA4077-4 are the sixth generation of the Analog Devices, Inc., industry-standard [OP07](#) amplifier family. The ADA4077-1/ADA4077-2/ADA4077-4 are high precision, low noise operational amplifiers with a combination of extremely low offset voltage and very low input bias currents. Unlike JFET amplifiers, the low bias and offset currents are relatively insensitive to ambient temperatures, even up to 125°C.

The Analog Devices proprietary process technology and linear design expertise have produced high voltage amplifiers with superior performance to the [OP07/OP77/OP177/OP1177](#) in tiny, 8-lead SOIC and 8-lead MSOP packages ([ADA4077-1](#) and [ADA4077-2](#)) and 14-lead TSSOP and 14-lead SOIC packages ([ADA4077-4](#)). Despite their small size, the ADA4077-1/ADA4077-2/ADA4077-4 offer numerous improvements, including low wideband noise, wide bandwidth, lower offset and offset drift, lower input bias current, and complete freedom from phase inversion.

The [ADA4077-1/ADA4077-2/ADA4077-4](#) have an operating temperature range of -40°C to +125°C with an MSL1 rating, which is as wide as any similar device in a plastic surface-mount package. This MSL1 rating is increasingly important as printed circuit board (PCB) and overall system sizes continue to shrink, causing internal system temperatures to rise.

In the ADA4077-1/ADA4077-2/ADA4077-4, the power consumption is reduced by a factor of four compared to the [OP177](#), and the bandwidth and slew rate are both increased by a factor of six. The low power dissipation and very stable performance vs. temperature also reduce warmup drift errors to insignificant levels.

Inputs are protected internally from overvoltage conditions referenced to either supply rail. Like any high performance amplifier, maximum performance is achieved by following appropriate circuit and PCB guidelines.

## APPLICATIONS INFORMATION

## OUTPUT PHASE REVERSAL

Phase reversal is defined as a change of polarity in the amplifier transfer function. Many operational amplifiers exhibit phase reversal when the voltage applied to the input is greater than the maximum common-mode voltage. In some instances, this phase reversal can cause permanent damage to the amplifier. In feedback loops, it can result in system lockups or equipment damage. The ADA4077-1/ADA4077-2/ADA4077-4 are immune to phase reversal problems even at input voltages beyond the power supply settings.

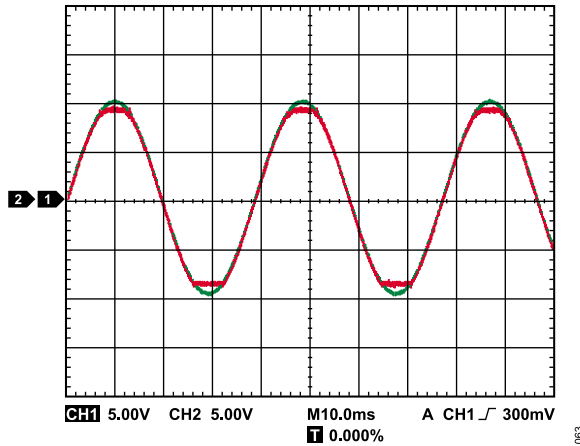

Figure 69. No Phase Reversal

## LOW POWER LINEARIZED RTD

A common application for a single element varying bridge is an RTD thermometer amplifier, as shown in Figure 70. The excitation is delivered to the bridge by a 2.5 V reference applied at the top of the bridge.

RTDs can have a thermal resistance as high as 0.5°C/mW to 0.8°C/mW. To minimize errors due to resistor drift, keep the current low through each leg of the bridge. In this circuit, the amplifier supply current flows through the bridge. However, at a maximum supply current of 500  $\mu$ A for the ADA4077-2, the RTD dissipates less than 0.1 mW of power, even at the highest resistance. Therefore, errors due to power dissipation in the bridge are kept under 0.1°C.

Calibration of the bridge is made at the minimum value of the temperature to be measured by adjusting  $R_P$  until the output is zero.

To calibrate the output span, set the full-scale and linearity potentiometers to midpoint, and apply a 500°C temperature to the sensor, or substitute the equivalent 500°C RTD resistance.

Adjust the full-scale potentiometer for a 5 V output. Finally, apply 250°C or the equivalent RTD resistance, and adjust the linearity potentiometer for a 2.5 V output. The circuit achieves higher than  $\pm 0.5^\circ\text{C}$  accuracy after adjustment.

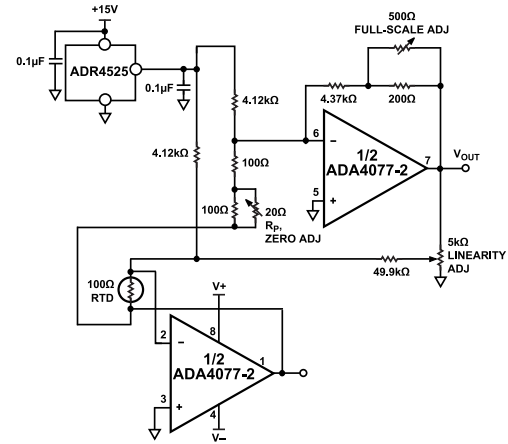

Figure 70. Low Power Linearized RTD Circuit

## PROPER BOARD LAYOUT

The ADA4077-1/ADA4077-2/ADA4077-4 are high precision devices. To ensure optimum performance at the PCB level, care must be taken in the design of the board layout.

To avoid leakage currents, maintain a clean and moisture free board surface. Coating the surface creates a barrier to moisture accumulation, and reduces parasitic resistance on the board.

Keeping supply traces short and properly bypassing the power supplies minimizes the power supply disturbances caused by the output current variation, such as when driving an ac signal into a heavy load. Connect bypass capacitors as closely as possible to the device supply pins. Stray capacitances are a concern at the outputs and the inputs of the amplifier. It is recommended that the signal traces be kept at least 5 mm from supply lines to minimize coupling.

A variation in temperature across the PCB can cause a mismatch in the Seebeck voltages at solder joints and other points where dissimilar metals are in contact, resulting in thermal voltage errors. To minimize these thermocouple effects, orient resistors so that heat sources warm both ends equally. Ensure, where possible, that input signal paths contain matching numbers and types of components, to match the number and type of thermocouple junctions. For example, dummy components such as zero value resistors can be used to match real resistors in the opposite input path. Place matching components in close proximity to each other, and orient them in the same manner. Ensure that leads are of equal length so that thermal conduction is in equilibrium. Keep heat sources on the PCB as far away from amplifier input circuitry as is practical.

The use of a ground plane is highly recommended. A ground plane reduces electromagnetic interference (EMI) noise and maintains a constant temperature across the circuit board.

## LONG-TERM DRIFT

The stability of a precision signal path over its lifetime or between calibration procedures is dependent on the long-term stability of the

APPLICATIONS INFORMATION

analog components in the path, such as op amps, references, and data converters. To help system designers predict the long-term drift of circuits that use the ADA4077-1/ADA4077-2/ADA4077-4, Analog Devices measured the offset voltage of multiple units for 10,000 hours (more than 13 months) using a high precision measurement system, including an ultrastable oil bath. To replicate real-world system performance, the devices under test (DUTs) were soldered onto an FR4 PCB using a standard reflow profile (as defined in the JEDEC J-STD-020D standard), as opposed to testing them in sockets. This manner of testing is important because expansion and contraction of the PCB can apply stress to the integrated circuit (IC) package and contribute to shifts in the offset voltage.

The ADA4077-1/ADA4077-2/ADA4077-4 have extremely low long-term drift (LTD). Figure 71 shows the LTD of the ADA4077-1 (SOIC package). The red, blue, and green traces show sample units. Note that the mean drift over 10,000 hours is less than 0.5  $\mu\text{V}$ , or less than 2% of their maximum specified offset voltage of 25  $\mu\text{V}$  at room temperature.

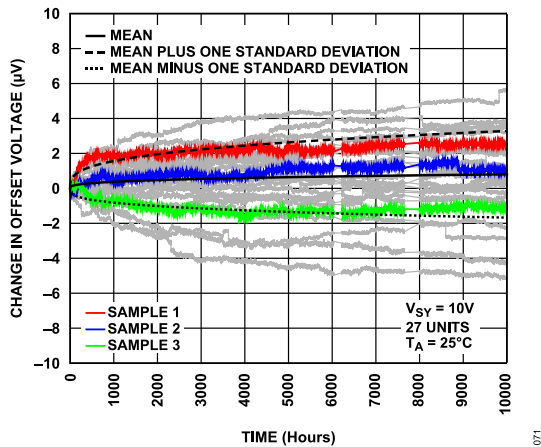

Figure 71. Measured Long-Term Drift of the ADA4077-1/ADA4077-2/ADA4077-4 Offset Voltage over 10,000 Hours

TEMPERATURE HYSTERESIS

In addition to stability over time as described in the Long-Term Drift section, it is useful to know the temperature hysteresis, that is, the stability vs. cycling of temperature. Hysteresis is an important parameter because it tells the system designer how closely the signal returns to its starting amplitude after the ambient temperature changes and subsequent return to room temperature. Figure 72 shows the change in input offset voltage as the temperature cycles three times from room temperature to 125°C to -40°C and back to room temperature. The dotted line is an initial preconditioning cycle to eliminate the original temperature-induced offset shift from exposure to production solder reflow temperatures. In the three full cycles, the offset hysteresis is typically only 1  $\mu\text{V}$ , or 1.5% of its 65  $\mu\text{V}$  maximum offset voltage over the full operating temperature range. The histogram in Figure 73 shows that the hysteresis is

larger when the device is cycled through only a half cycle, from room temperature to 125°C and back to room temperature.

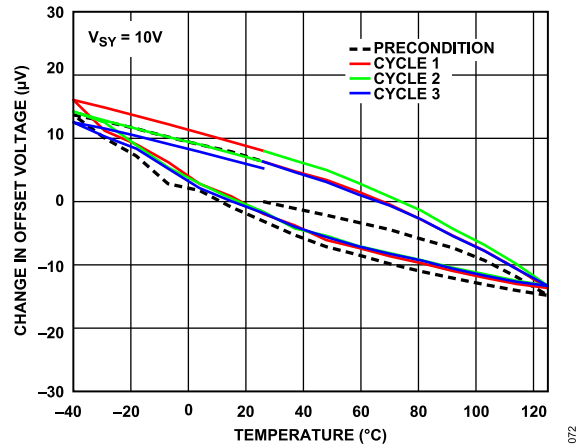

Figure 72. Change in Offset Voltage over Three Full Temperature Cycles

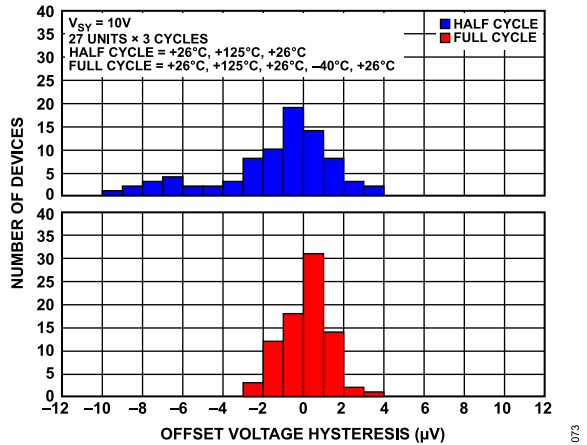
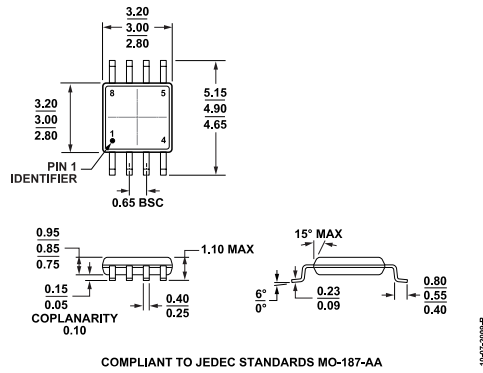
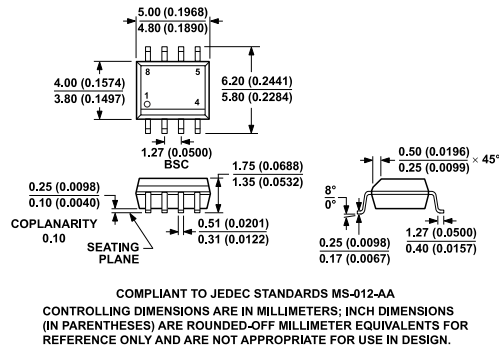

Figure 73. Histogram Showing the Temperature Hysteresis of the Offset Voltage over Three Full Cycles and over Three Half Cycles

OUTLINE DIMENSIONS



**Figure 74. 8-Lead Mini Small Outline Package [MSOP] (RM-8)**  
Dimensions shown in millimeters



**Figure 75. 8-Lead Standard Small Outline Package [SOIC\_N] Narrow Body (R-8)**  
Dimensions shown in millimeters and (inches)

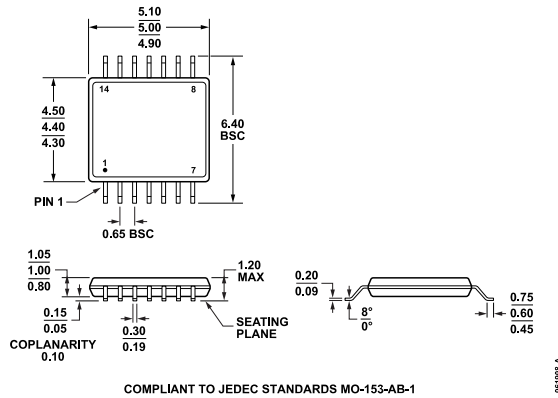

**Figure 76. 14-Lead Thin Shrink Small Outline Package [TSSOP] (RU-14)**  
Dimensions shown in millimeters



OUTLINE DIMENSIONS

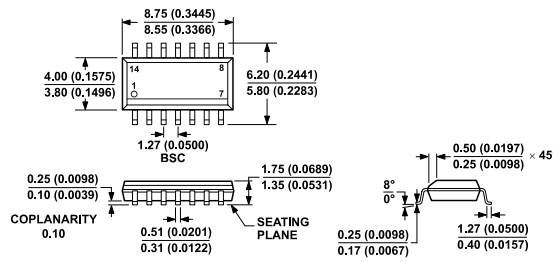

COMPLIANT TO JEDEC STANDARDS MS-012-AB  
 CONTROLLING DIMENSIONS ARE IN MILLIMETERS; INCH DIMENSIONS  
 (IN PARENTHESES) ARE ROUNDED-OFF MILLIMETER EQUIVALENTS FOR  
 REFERENCE ONLY AND ARE NOT APPROPRIATE FOR USE IN DESIGN.

Figure 77. 14-Lead Standard Small Outline Package [SOIC\_N]  
 Narrow Body  
 (R-14)  
 Dimensions shown in millimeters and (inches)

Updated: July 18, 2022

ORDERING GUIDE

| Model <sup>1</sup> | Temperature Range | Package Description | Packing Quantity | Package Option | Marking Code |
|--------------------|-------------------|---------------------|------------------|----------------|--------------|
| ADA4077-1ARMZ      | -40°C to +125°C   | 8-Lead MSOP         |                  | RM-8           | A35          |
| ADA4077-1ARMZ-R7   | -40°C to +125°C   | 8-Lead MSOP         | Reel, 1000       | RM-8           | A35          |
| ADA4077-1ARMZ-RL   | -40°C to +125°C   | 8-Lead MSOP         | Reel, 3000       | RM-8           | A35          |
| ADA4077-1ARZ       | -40°C to +125°C   | 8-Lead SOIC         |                  | R-8            |              |
| ADA4077-1ARZ-R7    | -40°C to +125°C   | 8-Lead SOIC         | Reel, 1000       | R-8            |              |
| ADA4077-1ARZ-RL    | -40°C to +125°C   | 8-Lead SOIC         | Reel, 2500       | R-8            |              |
| ADA4077-1BRZ       | -40°C to +125°C   | 8-Lead SOIC         |                  | R-8            |              |
| ADA4077-1BRZ-R7    | -40°C to +125°C   | 8-Lead SOIC         | Reel, 1000       | R-8            |              |
| ADA4077-1BRZ-RL    | -40°C to +125°C   | 8-Lead SOIC         | Reel, 2500       | R-8            |              |
| ADA4077-2ARMZ      | -40°C to +125°C   | 8-Lead MSOP         |                  | RM-8           | A2X          |
| ADA4077-2ARMZ-R7   | -40°C to +125°C   | 8-Lead MSOP         | Reel, 1000       | RM-8           | A2X          |
| ADA4077-2ARMZ-RL   | -40°C to +125°C   | 8-Lead MSOP         | Reel, 3000       | RM-8           | A2X          |
| ADA4077-2ARZ       | -40°C to +125°C   | 8-Lead SOIC         |                  | R-8            |              |
| ADA4077-2ARZ-R7    | -40°C to +125°C   | 8-Lead SOIC         | Reel, 1000       | R-8            |              |
| ADA4077-2ARZ-RL    | -40°C to +125°C   | 8-Lead SOIC         | Reel, 2500       | R-8            |              |
| ADA4077-2BRZ       | -40°C to +125°C   | 8-Lead SOIC         |                  | R-8            |              |
| ADA4077-2BRZ-R7    | -40°C to +125°C   | 8-Lead SOIC         | Reel, 1000       | R-8            |              |
| ADA4077-2BRZ-RL    | -40°C to +125°C   | 8-Lead SOIC         | Reel, 2500       | R-8            |              |
| ADA4077-4ARUZ      | -40°C to +125°C   | 14-Lead TSSOP       |                  | RU-14          |              |
| ADA4077-4ARUZ-R7   | -40°C to +125°C   | 14-Lead TSSOP       | Reel, 1000       | RU-14          |              |
| ADA4077-4ARUZ-RL   | -40°C to +125°C   | 14-Lead TSSOP       | Reel, 2500       | RU-14          |              |
| ADA4077-4ARZ       | -40°C to +125°C   | 14-Lead SOIC        |                  | R-14           |              |
| ADA4077-4ARZ-R7    | -40°C to +125°C   | 14-Lead SOIC        | Reel, 1000       | R-14           |              |
| ADA4077-4ARZ-RL    | -40°C to +125°C   | 14-Lead SOIC        | Reel, 2500       | R-14           |              |

<sup>1</sup> Z = RoHS Compliant Part.