

Features

- RoHS compliant*
- Low profile
- Low power loss, high efficiency
- UL 94V-0 classification

Applications

- Switch Mode Power Supplies
- Portable equipment batteries
- High frequency rectification
- DC/DC Converters
- Telecommunications

CD214C-S3x Series Rectifier Chip Diode

General Information

Portable communications, computing and video equipment manufacturers are challenging the semiconductor industry to develop increasingly smaller electronic components.

Bourns offers Glass Passivated Rectifiers for rectification applications in a compact chip package compatible with DO-214AB (SMC) size format. The Glass Passivated Rectifier Diodes offer a forward current of 3 A with a choice of repetitive peak reverse voltage of 200 V up to 1000 V.



Absolute Maximum Ratings (@ T_A = 25 °C Unless Otherwise Noted)

Parameter	Symbol	CD214C-					Unit
		S3D	S3G	S3J	S3K	S3M	
Maximum Repetitive Peak Reverse Voltage	V _{RRM}	200	400	600	800	1000	V
Maximum Average Forward Current	I _{F(AV)}	3					A
Maximum Peak Forward Surge Current (8.3 ms Single Half Sine-Wave)	I _{SM}	100					A
Operating Junction Temperature Range	T _{OPR}	-65 to +175					°C
Storage Temperature Range	T _{STG}	-65 to +175					°C

Electrical Characteristics (@ T_A = 25 °C Unless Otherwise Noted)

Parameter	Symbol	Condition	Min.	Typ.	Max.	Unit
Maximum Instantaneous Forward Voltage (NOTE 1)	V _F	I _F = 3 A		0.96	1	V
DC Reverse Current	I _R	V _R = V _{RRM}		0.1	5	μA
Typical Thermal Resistance (NOTE 2)	Junction to Ambient	R _{θJA}		118		°C/W
	Junction to Lead	R _{θJL}		32		

NOTES:

(1) Pulse width 300 microsecond, 1 % duty cycle.

(2) Mounted on PCB with 5.0 x 5.0 mm (0.2 x 0.2 inch) copper pad areas.

*RoHS Directive 2002/95/EC Jan. 27, 2003 including annex and RoHS Recast 2011/65/EU June 8, 2011.

Specifications are subject to change without notice.

The device characteristics and parameters in this data sheet can and do vary in different applications and actual device performance may vary over time. Users should verify actual device performance in their specific applications.

CD214C-S3x Series Rectifier Chip Diode

BOURNS®

Performance Graphs

Forward Current Derating Curve

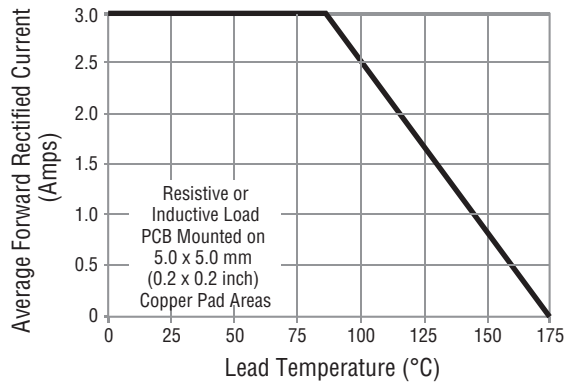

Maximum Peak Forward Surge Current

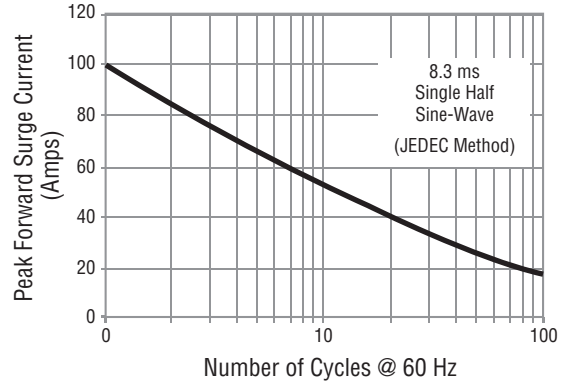

Typical Instantaneous Forward Characteristics

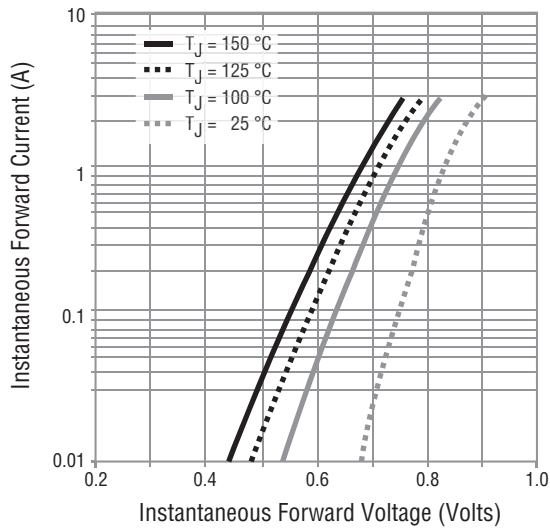

Typical Reverse Characteristics

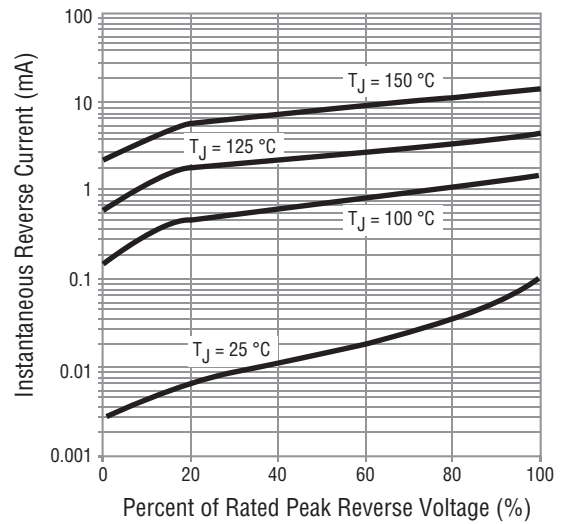

Specifications are subject to change without notice.
The device characteristics and parameters in this data sheet can and do vary in different applications and actual device performance may vary over time.
Users should verify actual device performance in their specific applications.

CD214C-S3x Series Rectifier Chip Diode



Product Dimensions

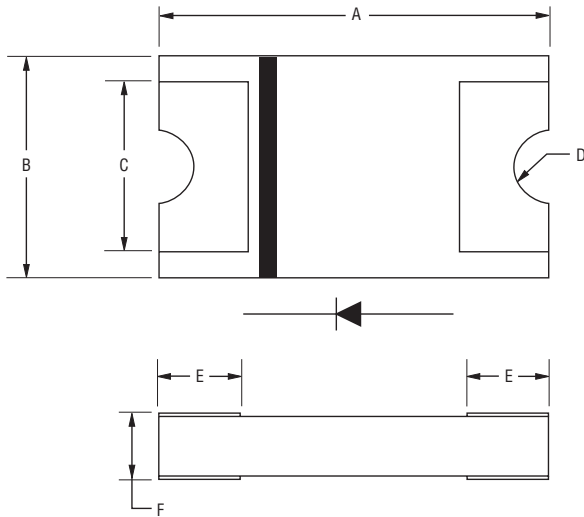

Dimension	CD214C-S3 Series
A	$\frac{8.0 \pm 0.10}{(0.315 \pm 0.004)}$
B	$\frac{5.0 \pm 0.10}{(0.197 \pm 0.004)}$
C	$\frac{3.90}{(0.154)}$ TYP.
D	$\frac{0.80 \pm 0.02}{(0.031 \pm 0.001)}$
E	$\frac{1.95 \pm 0.10}{(0.077 \pm 0.004)}$
F	$\frac{1.10 \pm 0.15}{(0.043 \pm 0.006)}$

DIMENSIONS: $\frac{\text{MM}}{\text{(INCHES)}}$

How to Order

CD 214C - S 3 D

- Common Code _____
- CD = Chip Diode
- Package _____
- 214C = SMC/DO-214AB Compatible
- Model _____
- S = Glass Passivated Rectifier Series
- Maximum Average Forward Rectified Current _____
- 3 = 3 A
- Maximum Repetitive Peak Reverse Voltage _____
- D = 200 V
- G = 400 V
- J = 600 V
- K = 800 V
- M = 1000 V

Recommended Pad Layout

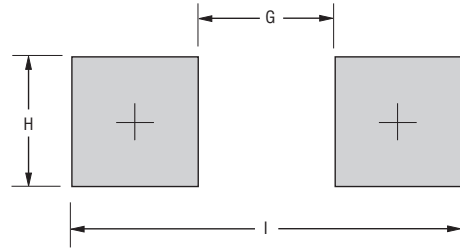

Dimension	CD214C-S3 Series
G	$\frac{4.10}{(0.161)}$ MAX.
H	$\frac{3.90}{(0.154)}$ MIN.
I	$\frac{11.90}{(0.469)}$ REF.

DIMENSIONS: $\frac{\text{MM}}{\text{(INCHES)}}$

Environmental Specifications

Moisture Sensitivity Level..... 1
 ESD Classification (HBM)..... 3B

Typical Part Marking

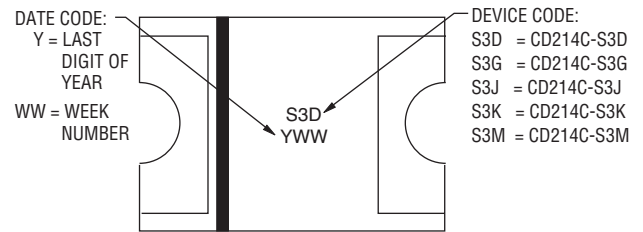

Specifications are subject to change without notice.
 The device characteristics and parameters in this data sheet can and do vary in different applications and actual device performance may vary over time.
 Users should verify actual device performance in their specific applications.

CD214C-S3x Series Rectifier Chip Diode

BOURNS®

Packaging Information

The product is dispensed in tape and reel format (see diagram below).

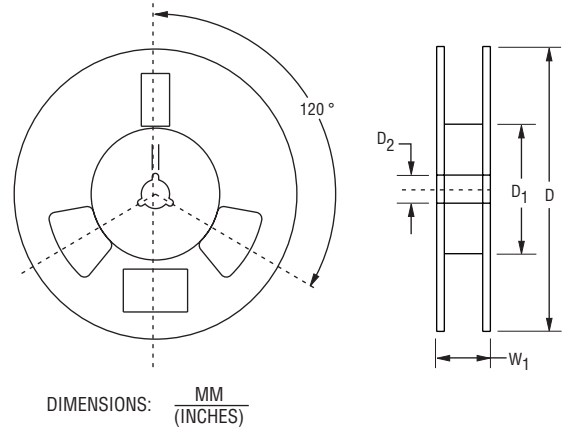
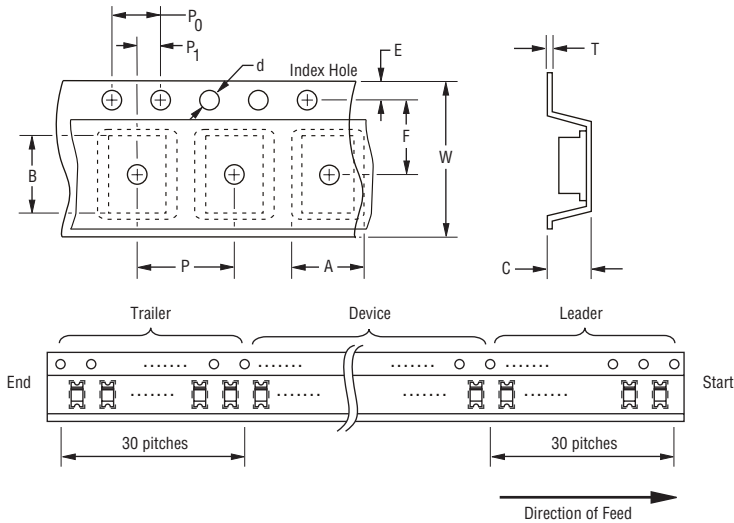

Item	Symbol	CD214C-S3 Series
Carrier Width	A	$\frac{5.56 \pm 0.10}{(0.219 \pm 0.004)}$
Carrier Length	B	$\frac{8.18 \pm 0.10}{(0.322 \pm 0.004)}$
Carrier Depth	C	$\frac{2.50}{(0.098)}$ MAX.
Sprocket Hole	d	$\frac{1.55 \pm 0.05}{(0.061 \pm 0.002)}$
Reel Outside Diameter	D	$\frac{330 \pm 2.0}{(12.992 \pm 0.079)}$
Reel Inner Diameter	D ₁	$\frac{50.0}{(1.969)}$ MIN.
Feed Hole Diameter	D ₂	$\frac{13.0 \pm 0.50}{(0.512 \pm 0.020)}$
Sprocket Hole Position	E	$\frac{1.75 \pm 0.10}{(0.069 \pm 0.004)}$
Punch Hole Position	F	$\frac{7.50 \pm 0.10}{(0.295 \pm 0.004)}$
Punch Hole Pitch	P	$\frac{8.00 \pm 0.10}{(0.315 \pm 0.004)}$
Sprocket Hole Pitch	P ₀	$\frac{4.00 \pm 0.10}{(0.157 \pm 0.004)}$
Embossment Center	P ₁	$\frac{2.00 \pm 0.10}{(0.079 \pm 0.004)}$
Overall Tape Thickness	T	$\frac{0.40}{(0.016)}$ MAX.
Tape Width	W	$\frac{16.00 \pm 0.30}{(0.630 \pm 0.012)}$
Reel Width	W ₁	$\frac{22.7}{(0.893)}$ MAX.
Quantity per Reel	--	3,000

BOURNS®

Asia-Pacific:

Tel: +886-2 2562-4117
Email: asiacus@bourns.com

Europe:

Tel: +36 88 520 390
Email: eurocus@bourns.com

The Americas:

Tel: +1-951 781-5500
Email: americus@bourns.com

www.bourns.com

01/18

Specifications are subject to change without notice. The device characteristics and parameters in this data sheet can and do vary in different applications and actual device performance may vary over time. Users should verify actual device performance in their specific applications.

Mouser Electronics

Authorized Distributor

Click to View Pricing, Inventory, Delivery & Lifecycle Information:

Bourns:

[CD214C-S3M](#) [CD214C-S3K](#) [CD214C-S3G](#) [CD214C-S3J](#) [CD214C-S3D](#)